



CODE OF GENERAL ORDINANCES

Effective as of August 20, 2021

Table of Contents

CHAPTER I CITY GOVERNMENT	1
1.01 COMMON COUNCIL.....	1
1.012 CODE OF GENERAL [GENERAL AND ZONING] ORDINANCES.....	3
1.015 ALDERMANIC VACANCIES-HOW FILLED.....	4
1.016 MAYORAL VACANCY-HOW FILLED	4
1.02 MEETINGS OF THE COMMON COUNCIL.....	5
1.025 DRESS CODE FOR MEMBERS OF THE COMMON COUNCIL	6
1.027 FACE COVERINGS FOR MEMBERS OF THE COMMON COUNCIL	7
1.03 RULES OF COUNCIL.....	8
1.035 SMOKING AT MEETINGS OF THE COMMON COUNCIL	16
1.04 MAYOR	16
1.045 WITHHOLDING OF THE ISSUANCE OF CITY LICENSES AND PERMITS BY THE CITY CLERK..	17
1.046 CITY MANAGEMENT.....	18
1.05 CITY DEPARTMENTS	18
1.055 DEPARTMENT OF MUNICIPAL COURT	25
1.056 ELIGIBILITY FOR APPOINTMENT TO CITY BOARDS, COMMISSIONS, AUTHORITIES AND COMMITTEES	28
1.06 CITY BOARDS AND COMMISSIONS	28
1.06 A.A. BOARD OF HOUSING APPEALS.....	40
1.065 KENOSHA AREA BUSINESS ALLIANCE, INC.....	41
1.067 SISTER CITIES ASSOCIATION OF KENOSHA, WISCONSIN, INC.....	41
1.07 OFFICIAL BONDS AND OATHS	42
1.08 COMPENSATION OF PERSONNEL.....	42
1.09 MILITARY LEAVE OF ABSENCE.....	42
1.10 CIVIL SERVICE - (See Charter Ordinance No. 29.).....	42
1.11 SUPERVISORS-See Statutes	42
1.12 OPENING OF POLLS.....	42
1.121 ABSENTEE BALLOTS	42
1.13 COMPULSORY RETIREMENT	43
1.14 CITY PARTICIPATION IN JOINT ACTION EMERGENCY GOVERNMENT FOR KENOSHA COUNTY	43
1.145 EMERGENCY POWERS OF THE MAYOR.....	45
1.15 ANNEXATION ORDINANCES PRELIMINARY REPORTS.....	46
1.155 DEFERRED ASSESSMENTS PAYABLE UPON ANNEXATION	47
1.17 SEVERABILITY	47
1.18 LICENSES-PUBLIC NUISANCE.....	47
1.19 REFERENCES TO STATE LAW	47
1.20 PRESERVATION AND DESTRUCTION OF CITY RECORDS	48
1.21 DISPOSAL OF ABANDONED AND UNCLAIMED PROPERTY.....	48

1.22 LICENSE/PERMIT APPLICATIONS	48
1.225 ADMINISTRATIVE CHARGE FOR PROCESSING LICENSE/PERMIT APPLICATIONS	49
1.23 SCHOOL CROSSING GUARDS	49
1.24 VOLUNTEERS	49
1.25 VANDALISM CONTROL REWARDS	49
1.26 EMPLOYEE INVOLVEMENT IN CITY GOVERNMENT/POLICY & PROCEDURE	49
1.27 POLL WORKERS	50
1.28 RESIDENCY REQUIREMENT	51
1.29 HARASSMENT POLICY & PROCEDURE	52
1.295 CONFIDENTIALITY AND IMPARTIALITY	56
1.30 INTERNET USAGE AND ELECTRONIC MAIL (E-MAIL) POLICY	57
1.31 PUBLIC ART DONATIONS - GUIDELINES AND PROCEDURES	59
1.32 CITY BACKGROUND INVESTIGATIONS AND POLICE RECORD CHECKS REGARDING EMPLOYEES, APPLICANTS FOR EMPLOYMENT AND PROSPECTIVE APPOINTEES TO ANY OFFICE	61
CHAPTER II FINANCE	1
2.01 FISCAL YEAR	1
2.015 LEASE/CONTRACT ADMINISTRATION	1
2.02 BUDGET	2
2.03 TAX AND APPROPRIATIONS	3
2.04 INSTALLMENT PAYMENT OF TAXES - DELINQUENT TAXES	3
2.041. DISBURSEMENT OF STATE CREDITS TO THE CITY	4
2.05 DISBURSEMENTS	4
2.06 PAYMENT OF FEES	4
2.07 ACCOUNTS AND AUDIT	4
2.08 CLAIMS	4
2.09 SUBSTITUTION FOR TREASURER'S BOND	4
2.095 COST RECOVERY FOR INSTALLATION OF CITY PUBLIC INFRASTRUCTURE	5
2.10 SPECIAL ASSESSMENTS	6
2.11 PARK ACQUISITION AND IMPROVEMENT FUND	8
2.12 TRAVEL EXPENSES	8
2.13 PRESERVATION OF RECORDS, MICROFILM	8
2.15 COMMISSIONS--CITY PROPERTY	8
2.16 HOTEL-MOTEL ROOM TAX	9
2.17 INDUSTRIAL REVENUE BONDS	11
2.18 KENOSHA LAKESHORE BUSINESS IMPROVEMENT DISTRICT	12
2.19 UPTOWN BUSINESS IMPROVEMENT DISTRICT	13
2.20 EMERGENCY MEDICAL SERVICE USER FEES	13
2.21 EMERGENCY ACTION - RECOVERY OF ENVIRONMENTAL CLEANUP COSTS	14
2.22 MANAGEMENT IDENTIFICATION BY APPLICANTS FOR CITY FUNDING	15

CHAPTER III	1
FIRE PREVENTION BUREAU.....	1
3.01 BUREAU OF FIRE PREVENTION.....	1
3.02 FIRE PREVENTION CODE	1
3.03 PROVISIONS OF CODE	1
3.04 RESPONSIBILITY	2
3.05 DUTIES	2
3.06 BUILDINGS, STRUCTURES AND PREMISES AFFECTED	3
3.07 AUTHORITY TO ENTER PREMISES.....	3
3.08 CLOSING AND VACATING OF BUILDINGS AND STRUCTURES.....	3
3.09 NOTICES AND ORDERS	3
3.10 INVESTIGATION OF FIRES.....	4
3.11 FIRE DEPARTMENT EMERGENCY AMBULANCE AND RESCUE SERVICE.....	4
3.12 FEES FOR VEHICULAR FIRE/HAZARDOUS MATERIALS SUPPRESSION SERVICES	4
3.13 FEES.....	5
3.14 REVOCATION OF PERMIT(S).....	6
3.15 FIRE PREVENTION EDUCATION AND FIRE DRILLS.....	6
3.16 FIRE EXTINGUISHING EQUIPMENT	6
3.17 FALSE FIRE ALARM: DESTROYING, REMOVING, INJURING OR MEDDLING WITH FIRE ALARM SYSTEMS	7
3.18 FIREWORKS.....	7
3.19 CONTROL OF OPEN BURNING; OPEN FLAMES IN BUILDINGS	7
3.20 HAZARDOUS MATERIALS.....	10
3.21 MAINTENANCE AND STORAGE OF COMBUSTIBLE MATERIALS.....	10
3.22 EXPLOSIVES.....	11
3.23 AUTOMATIC FIRE SPRINKLER SYSTEMS.....	12
3.24 FIRE DEPARTMENT STANDPIPES	17
3.25 FIRE ALARMS.....	17
3.26 FIRE PROTECTION SYSTEMS	17
3.27 EXIT SIGNS IN PROXIMITY OF FLOOR	20
3.28 PERMANENT ROOF ANCHORAGE REQUIRED	20
3.29 HOOD SYSTEMS AND DUCT-FIRE EXTINGUISHER SYSTEM.....	21
3.30 EMERGENCY RESPONSE ENCLOSURES	21
3.31 STANDPIPES FOR PARKING STRUCTURES	23
3.32 STORAGE TANKS FOR CLASS I, II AND III LIQUIDS	23
3.33 APPEALS.....	23
3.34 FAILURE TO COMPLY WITH ORDERS	24
3.35 PENALTIES, GENERAL.....	24
3.26 VALIDITY	24
CHAPTER IV HEALTH.....	1

4.01 ADMINISTRATOR OF HEALTH	1
4.02 MANURE	1
4.03 MOBILE HOMES AND PARKS.....	1
4.04 BUSINESS CAPACITY AND FACE COVERING REGULATIONS PERTAINING TO CORONAVIRUS (COVID-19)	1
4.05 SMOKING PROHIBITED	4
4.06 RENDERING PLANTS	5
4.07 ARTIFICIAL LIGHT AND GLARE.....	5
4.08 PENALTIES.....	5
CHAPTER V	1
PUBLIC WORKS AND SERVICES	1
5.01 PUBLIC WORKS GENERAL	1
5.02 UNDERGROUND UTILITIES IN RECONSTRUCTED MAJOR STREETS.....	1
5.03 STORM SEWERS	1
5.035 SURFACE WATER DRAINAGE FLOW	2
5.039 PUBLIC RIGHT-OF-WAY RESTORATION STANDARDS	2
5.04 PUBLIC UTILITIES, RIGHT-OF-WAY EXCAVATION, STREETS, AND ALLEYS	2
5.041 HONORARY STREET SUBNAMES	18
5.045 BANNERS, SIGNS, DECORATIONS AND OBSTRUCTIONS IN PUBLIC RIGHT-OF-WAY	19
5.046 OUTDOOR DINING AREA LOCATED IN A PUBLIC RIGHT-OF-WAY, MAJOR STREET SETBACK	21
AREA OR ON PUBLIC PROPERTY.....	21
5.05 CONSTRUCTION OF SIDEWALKS AND DRIVEWAY APPROACHES.....	27
5.051 LAWN PARK AREAS.....	30
5.06 CURBSIDE WASTE AND RECYCLING COLLECTION AND REMOVAL	32
5.07 REMOVAL OF TREES IN HIGHWAY	36
5.08 PARKING FACILITIES	37
5.085 DRIVEWAY APPROACHES.....	40
5.09 INSTALLATION OF MODERN (ORNAMENTAL) LIGHTING	45
5.10 MINIMUM WAGE SCALE FOR CERTAIN PUBLIC WORKS CONTRACTS	47
5.11 SIDEWALKS AND ALLEYS TO BE KEPT CLEAN BY RESPONSIBLE PARTY	49
5.115 SUMP PUMPS	50
5.116 SIDEWALK INSPECTION AND REPLACEMENT POLICY AND PROCEDURE	51
5.117 CONTROL OF NOXIOUS WEEDS.....	52
5.118 CITY OWNED CEMETERIES.....	53
5.119 RECYCLING	53
5.12 PENALTIES.....	59
CHAPTER VI.....	1
PARKS	1
6.01 PARKS	1

6.02 RULES AND REGULATIONS.....	1
6.03 EMERGENCY CLOSING OF PARKS.....	4
6.04 RULES FOR THE DESIGNATION AND MAINTENANCE OF NAMES FOR PUBLIC PARKS AND RECREATIONAL AREAS.....	5
6.05 PERMITS	7
6.06 PROTECTION OF BEACHES	10
6.065 NATURE AREAS.....	10
6.07 BOULEVARDS.....	11
6.08 DUMPING OF ICE OR SNOW ON PARK PROPERTY	11
6.09 PENALTIES.....	11
CHAPTER VII TRAFFIC REGULATIONS.....	1
7.01 PROVISIONS OF STATE LAW ADOPTED BY REFERENCE	1
7.02 SPEED LIMITS.....	3
7.025 JURISDICTION OVER STREETS	4
7.03 THROUGH STREETS.....	5
7.04 PARKING REGULATIONS - HAZARD.....	6
7.041 PARKING REGULATIONS - UNREGISTERED VEHICLES	7
7.045 PARKING REGULATIONS - PROSECUTION.....	7
7.05 PARKING LIMITS.....	8
7.051 CONTINUOUS PARKING RESTRICTED TIME PARKING ZONES - SEPARATE VIOLATION.....	8
7.06 PARKING RESTRICTIONS.....	8
7.07 PARKING METERS	9
7.075 PARKING PASSES	10
7.08 ANGLE PARKING	11
7.09 TAXI STANDS	12
7.10 ONE WAY STREETS	12
7.11 LOADING ZONES	13
7.115 SIGNALIZED INTERSECTIONS.....	13
7.116 RIGHT TURN ON RED.....	15
7.12 STOP STREETS	15
7.125 STREETS CONTROLLED BY YIELD SIGNS	27
7.126 MOTOR VEHICLES - NUISANCES - REPAIR WORK.....	31
7.127 DISTRIBUTION OF LITERATURE PROHIBITED.....	34
7.128 TOWING OF ILLEGALLY PARKED VEHICLES	35
7.129 PARKING OF CERTAIN MOTOR VEHICLES AND EQUIPMENT PROHIBITED ON THE EXTERIOR OF ANY RESIDENTIAL PROPERTY AND ON ANY PUBLIC STREET, HIGHWAY, ALLEY, THOROUGHFARE OR RIGHT-OF-WAY IN ANY RESIDENTIAL ZONING DISTRICT OF THE CITY	36
7.13 MISCELLANEOUS.....	37
7.131 COMMERCIAL VISUAL CLEARANCE	41
7.135 BICYCLE, TRICYCLE, UNICYCLE REGISTRATION	41
7.14 BICYCLE, TRICYCLE, UNICYCLE, SKATEBOARD, SCOOTER AND ROLLER SKATE	

REGULATIONS.....	41
7.145 OPERATION OF BICYCLE WITHOUT OWNER'S CONSENT	44
7.15 IGNITION KEYS IN PARKED CARS.....	44
7.16 RESTRICTING HEAVY VEHICLE TRAFFIC AND PARKING	44
7.17 RIGHT-OF-WAY WHERE YIELD SIGNS ARE INSTALLED	45
7.19 DUTIES OF PEDESTRIANS AND OPERATORS OF VEHICLES TO EACH OTHER	45
7.195 MOTORIZED VEHICLES PROHIBITED ON SIDEWALKS	46
7.20 TEXT MESSAGING WHILE DRIVING	47
7.22 CELL PHONE USE WHILE DRIVING.....	47
7.23 AUTHORIZED EMERGENCY VEHICLES	48
7.24 REFERENCE TO STATUTES	49
7.25 ENFORCEMENT	49
7.26 PENALTIES.....	49
CHAPTER VIII STORMWATER UTILITY	1
8.01 GENERAL	1
8.02 STORMWATER UTILITY ENTERPRISE FUND	1
8.03 DEFINITIONS.....	2
8.04 STORM WATER UTILITY RATES AND CHARGES	4
8.05 STORMWATER SERVICE AREAS.....	5
8.06 EXEMPTIONS	6
8.07 PROCEDURE FOR APPLYING FOR ADJUSTMENTS TO SERVICE CHARGES	7
8.08 PROCEDURE FOR APPLYING FOR CREDIT TO STORMWATER UTILITY SERVICE CHARGE	8
8.09 APPEALS PROCESS.....	8
8.10 PAYMENTS.....	9
8.11 SEVERABILITY	10
CHAPTER IX BUILDING CODE	1
9.01 TITLE	1
9.02 DEFINITIONS.....	1
9.03 GENERAL	2
9.04 POWERS AND DUTIES OF CODE OFFICIAL	4
9.05 PERMIT APPLICATION	4
9.06 PERMIT.....	5
9.07 FEES.....	7
9.08 ENFORCEMENT PROCEDURE	9
9.09 CERTIFICATE OF OCCUPANCY.....	10
9.10 ONE AND TWO FAMILY DWELLINGS	11
9.105 WINDOWS IN HOTEL BEDROOMS	12
9.11 UNSAFE BUILDINGS.....	13
9.12 EXISTING BUILDINGS.....	13
9.13 TEMPORARY BUILDINGS AND USES.....	14

9.14 STREET OCCUPANCY FOR DUMPSTERS	14
9.15 VACANT BUILDINGS.....	15
9.16 MOVING OF BUILDINGS.....	15
9.17 RAZING OF BUILDINGS.....	17
9.18 SWIMMING POOLS; HOT TUBS; SPAS	19
9.19 PLUMBING QUALIFICATIONS	20
9.20 ELECTRICAL	20
9.21 HVAC	21
9.22 AIR CONDITIONING EQUIPMENT LOCATION ON SINGLE, TWO-FAMILY AND MULTI-FAMILY RESIDENTIAL BUILDINGS.....	22
9.23 STREET NUMBERING.....	22
9.24 SIDEWALK; CURB AND GUTTER; DRIVEWAY APPROACHES; DRIVEWAY APRONS	23
9.25 DOWNSPOUT DISCHARGE.....	23
9.26 RETAINING WALLS.....	23
9.27 EXCAVATIONS; DEPRESSIONS; PITS.....	24
9.28 STRUCTURAL INTERFERENCE WITH PUBLIC SAFETY RADIO COMMUNICATION.....	25
9.29 APPEALS.....	28
9.30 VIOLATIONS; PENALTIES.....	29
CHAPTER X ALCOHOL BEVERAGES	1
10.01 ADOPTION OF STATUTES	1
10.011 DEFINITIONS.....	1
10.015 CITY PARKS	1
10.02 LICENSE - FEES.....	2
10.03 LICENSE INVESTIGATION.....	3
10.04 RESTRICTIONS.....	6
10.045 WITHHOLDING OF ISSUANCE OF LICENSES.....	8
10.048 TEMPORARY "CLASS B" AND CLASS "B" LICENSES - APPLICATIONS.....	8
10.049 WITHDRAWAL OF LICENSE APPLICATION.....	9
10.05 REGULATIONS.....	9
10.062 CONDITIONAL SURRENDER WHERE REVOCATION OR SUSPENSION PROCEEDINGS THREATENED OR COMMENCED	12
10.063 POLICY & PROCEDURE FOR DISCIPLINARY ACTION RELATIVE TO ALL CLASS "A"/"CLASS A", CLASS "B"/"CLASS B" LIQUOR AND/OR FERMENTED MALT BEVERAGE LICENSES, AND "CLASS C" WINE LICENSE, OPERATOR'S LICENSES, AGENTS AND OTHER LICENSES AND PERMITS AUTHORIZED IN CHAPTER X	13
10.064 OFF LICENSED PREMISES CONDUCT OF PATRONS AND PERSONS AS A BASIS FOR DISCIPLINARY ACTIONS.....	18
10.07 CABARET LICENSE	20
10.074 OPEN CONTAINER ENTERTAINMENT EVENT.....	25
10.075 OUTDOOR EXTENSION OF A "CLASS B", CLASS "B" AND/OR "CLASS C" LICENSED PREMISES	28
10.076 OUTDOOR CAFÉ OF A "CLASS B", CLASS "B" AND/OR "CLASS C" LICENSED PREMISES IN A	

PUBLIC RIGHT-OF-WAY	31
10.077 UNOBSTRUCTED VIEW OF INTERIOR PREMISES	36
10.078 COVID-19 TEMPORARY OUTDOOR EXTENSION	37
10.08 PENALTIES.....	39
APPENDIX 10.063 - DEMERIT POINT SCHEDULE	40
CHAPTER XI OFFENSES AGAINST	1
11.02 DISORDERLY CONDUCT.....	1
11.021 INTIMIDATION OF PUBLIC OFFICIALS	5
11.022 TRESPASS	5
11.023 ELECTRONIC COMMUNICATION.....	6
11.024 CONTROL OF DOGS PURSUANT TO ORDER OF EMERGENCY PERSONNEL	6
11.025 SOCIAL HOST	6
11.026 PROHIBITING THE DRINKING OF INTOXICANTS ON PUBLIC STREETS AND SIDEWALKS, OR WITHIN ANY PARKED MOTOR VEHICLE.....	8
11.027 SERVICE STATIONS	9
11.028 PARENTAL RESPONSIBILITY.....	9
11.029 FALSE POLICE ALARMS.....	10
11.03 PROVISIONS OF STATE PROSTITUTION SUBCHAPTER ADOPTED BY REFERENCE	10
11.031 GRAFFITI	10
11.032 TRUANCY	11
11.033 SEXUAL OFFENDER RESIDENCY RESTRICTIONS	12
11.034 LOITERING-ILLEGAL DRUG ACTIVITY	17
11.035 DESIGNATION OF LOCATIONS WHERE LOITERING OR STANDING IS PROHIBITED UPON STREET MEDIANS.....	18
11.036 TRESPASS	18
11.04 GAMBLING	18
11.05 CURFEW.....	19
11.051 THEFT, DESTRUCTION, DEFACEMENT AND MUTILATION OF LIBRARY MATERIALS.....	19
11.052 THEFT OF CABLE SERVICE.....	20
11.053 RETAIL THEFT/FRAUD ON HOTEL OR RESTAURANT KEEPER OR TAXICAB OPERATOR OR GAS STATION	22
11.055 NONPAYMENT OF FARES.....	23
11.056 THEFT, DESTRUCTION, DEFACEMENT AND MUTILATION OF LIFE PRESERVERS	24
11.06 DANGEROUS WEAPONS	24
11.065 CARRYING FIREARM IN PUBLIC BUILDING.....	25
11.07 ENDURANCE CONTESTS.....	25
11.08 NUDITY IN A PUBLIC PLACE	25
11.085 MINORS PROHIBITED-ADULT USES	25
11.089 CONVERSION THERAPY	26
11.10 TAG DAYS	26
11.105 AUTOMATIC TELEPHONE DIALING DEVICE PROHIBITED	27

11.11 ABANDONED ICE BOXES AND REFRIGERATORS	28
11.135 USE OF CIGARETTES AND TOBACCO PRODUCTS PROHIBITED	28
11.14 PROHIBITING UNNECESSARY NOISES	28
11.141 REGULATION OF ALL-TERRAIN VEHICLES, SNOWMOBILES AND DIRT BIKES ON PUBLIC PROPERTY	29
11.143 REGULATION OF THE SALE, POSSESSION, TRANSFER AND USE OF TOXIC GLUES	30
11.144 REGULATION OF E-CIGARETTES	30
11.145 DRUG PARAPHERNALIA	31
11.146 POSSESSION OF MARIJUANA.....	32
11.147 SYNTHETIC MARIJUANA - SYNTHETIC CANNABINOID	32
11.148 SPRAY PAINTING.....	33
11.149 RUMMAGE/GARAGE SALES	34
11.15 PARKING PROHIBITED IN LOTS USED FOR RESIDENTIAL PURPOSES	34
11.16 HIRING OF PROFESSIONAL STRIKEBREAKERS PROHIBITED	34
11.17 PENALTIES.....	35
CHAPTER XII.....	1
AMUSEMENTS	1
12.001 AMUSEMENT DEVICE LICENSE	1
12.01 AMUSEMENT AND RECREATION ENTERPRISE LICENSE.....	2
12.02 CIRCUS, MENAGERIE, ETC.....	7
12.03 CARNIVALS	8
12.04 THEATERS	8
12.05 PUBLIC ENTERTAINMENT LICENSE	12
12.06 SPECIAL EVENT PERMIT	15
12.07 PENALTIES.....	20
CHAPTER XIII.....	1
BUSINESS LICENSES.....	1
13.01 SCRAP SALVAGE DEALERS AND SCRAP SALVAGE COLLECTORS	1
13.011 RECYCLING CENTER ACTIVITY LICENSE	10
13.0112 NON-STRUCTURAL DEMOLITION.....	16
13.015 TEMPORARY CEMENT BATCH PLANTS	20
13.02 PAWNBROKERS AND SECONDHAND ARTICLE AND JEWELRY DEALERS.....	21
13.025 CHARITABLE, RELIGIOUS AND POLITICAL SOLICITATIONS.....	29
13.03 PEDDLERS	29
13.031 USE OF UNLICENSED PEDDLERS PROHIBITED.....	32
13.035 PEDDLER'S STANDS AND OTHER STRUCTURES AS OBSTRUCTIONS	32
13.036 TRESPASS FOR COMMERCIAL PURPOSES.....	33
13.037 TRESPASS-PEDDLERS AND SOLICITORS.....	33
13.04 CONVENIENT CASH BUSINESSES.....	34
13.06 NATURAL GAS	34

13.07 TAXICABS AND DRIVERS.....	34
13.08 TAXICABS FROM OTHER JURISDICTIONS.....	43
13.09 TOBACCO SALES	43
13.10 CHRISTMAS TREES.....	46
13.11 FARMER MARKETS	47
13.12 TOWING SERVICE	48
13.125 MASSAGE ESTABLISHMENTS	53
13.13 REFUGE CENTERS.....	59
13.14 FEES.....	64
CHAPTER XIV	1
ANIMALS, BIRDS AND FOWL	1
14.001 DEFINITIONS.....	1
14.01 DOGS AND CATS.....	2
14.012 MANAGED CARE OF FERAL CATS.....	4
14.013 LIMITATION ON NUMBER OF DOGS AND CATS PER RESIDENTIALLY ZONED LOT	6
14.014 MAINTENANCE OF SANITARY CONDITIONS.....	7
14.015 KENNELS AND PET SHOPS	7
14.02 CERTAIN ANIMALS PROHIBITED; FOWLS REGULATED.....	12
14.024 VIETNAMESE POTBELLIED PIG LICENSE.....	13
14.025 HORSE DRAWN VEHICLES/LICENSE AND PERMIT - OTHER ANIMAL DRAWN VEHICLES	16
PROHIBITED	16
14.03 SANITATION.....	17
14.04 SALE OF BABY CHICKS, DUCKLINGS AND RABBITS	17
14.05 OPEN LOFTS FOR PIGEONS PROHIBITED.....	18
14.055 CRUELTY TO ANIMALS	18
14.06 TRAPPING	18
14.07 RABIES CONTROL.....	18
14.075 VICIOUS ANIMALS	22
14.076 ENFORCEMENT OF CHAPTER XIV AND CERTAIN STATE STATUTES	23
14.08 PENALTIES.....	24
14.09 ENFORCEMENT	25
14.10 SEVERABILITY	25
CHAPTER XV	1
SIGNS 1	
15.01 PURPOSE.....	1
15.02 DEFINITIONS AND INTERPRETATION.....	1
15.03 PROHIBITION	5
15.04 PERMITTED AND PROHIBITED SIGNS	5
15.05 SIGN NUMBER, AREA AND MEASUREMENT STANDARDS	5
15.06 ADDITIONAL SIGN CRITERIA.....	6

15.07 SIGN PERMIT	7
15.08 SIGN ERECTOR'S LICENSE	8
15.09 NONCONFORMING, ABANDONED AND OBSOLETE SIGNS	9
15.10 SIGNS IN STREET RIGHT-OF-WAY.....	9
15.101 SIGNS ON ABOVEGROUND UTILITY STRUCTURES IN OR ADJACENT TO THE PUBLIC RIGHT-.....	10
OF-WAY.....	10
15.11 EXEMPT SIGNS.....	10
15.12 PROHIBITED SIGNS.....	12
15.13 POWER AND AUTHORITY FOR REMOVAL OF NONCONFORMING AND/OR PROHIBITED SIGNS AND SIGN STRUCTURES.....	12
15.14 POLITICAL SIGNS	12
15.15 OFF-PREMISE SIGNS	13
15.16 CONSTRUCTION AND MAINTENANCE.....	16
15.161 REINSPECTION FEES	17
15.162 RECURRING VIOLATION.....	17
15.17 APPEALS AND SPECIAL EXCEPTIONS.....	17
15.18 PENALTY	18
CHAPTER XVI	1
PROPERTY MAINTENANCE CODE.....	1
16.01 TITLE	1
16.02 DEFINITIONS.....	1
16.03 GENERAL	5
16.04 APPLICABILITY	5
16.05 CODE OFFICIAL.....	6
16.06 POWERS AND DUTIES OF CODE OFFICIALS.....	6
16.07 APPROVAL OF ALTERNATIVE MATERIALS, METHODS AND EQUIPMENT	7
16.08 VIOLATIONS.....	8
16.09 NOTICES AND ORDERS	8
16.10 UNSAFE, UNFIT FOR OCCUPANCY, UNLAWFULLY OCCUPIED, VACANT SUBSTANDARD STRUCTURES AND UNSAFE EQUIPMENT	9
16.101 STANDARDS FOR SECURING STRUCTURES	10
16.11 EMERGENCY MEASURES.....	10
16.12 RAZING STRUCTURES.....	10
16.13 BOARD OF HOUSING APPEALS	11
16.14 LODGING HOUSES.....	11
16.141 PROHIBITION OF RESIDENTIAL TENANCIES OF LESS THAN SEVEN DAYS.....	13
16.15 RENT WITHHOLDING	15
16.151 CHRONIC NUISANCE PROPERTY	17
16.16 GENERAL PROPERTY MAINTENANCE REQUIREMENTS.....	19
16.17 EXTERIOR PREMISES.....	20

16.18 EXTERIOR OF STRUCTURES	23
16.19 INTERIOR OF RESIDENTIAL UNITS.....	25
16.20 WASTE COLLECTION AND REMOVAL AND RECYCLING.....	26
16.21 INFESTATION AND EXTERMINATION.....	27
16.22 LIGHT, VENTILATION AND OCCUPANCY LIMITATIONS.....	27
16.23 PLUMBING SYSTEMS FACILITIES AND FIXTURE REQUIREMENTS	30
16.24 MECHANICAL AND ELECTRICAL FACILITIES AND EQUIPMENT	32
16.25 FIRE SAFETY REQUIREMENTS	34
16.251 REINSPECTION FEES	37
16.26 PENALTIES.....	38
CHAPTER XVII	1
DIVISIONS AND COMBINATIONS OF LAND	1
17.01 AUTHORITY, PURPOSE, INTENT AND DEFINITIONS	1
17.02 DEFINITIONS.....	2
17.03 GENERAL PROVISIONS	4
17.04 LAND DIVISION PROCEDURES AND REQUIREMENTS	6
17.05 PRELIMINARY PLAT	11
17.06 FINAL PLAT	13
17.07 CERTIFIED SURVEY MAP	14
17.08 LOT LINE ADJUSTMENT SURVEY	15
17.081 PARCEL COMBINATION	16
17.09 DESIGN STANDARDS FOR LAND DIVISIONS	17
17.10 REQUIRED IMPROVEMENTS.....	21
17.11 DEVELOPMENT AGREEMENTS.....	22
17.12 CONSTRUCTION.....	23
17.13 FEES.....	25
CHAPTER XVIII	1
KENOSHA REGIONAL AIRPORT	1
18.01 DEFINITIONS OF WORDS AND PHRASES AS USED IN THIS ORDINANCE, UNLESS THE CONTEXT OTHERWISE REQUIRES	1
18.02 AIRPORT COMMISSION-POWERS AND DUTIES	2
18.03 AIRPORT DEVELOPMENT CODE.....	2
18.04 BUILDINGS	4
18.05 LEASES, CONCESSIONS AND CONTRACTS FOR USE OF LAND	4
18.06 REGULATIONS OF VEHICULAR TRAFFIC.....	5
18.065 PERSONAL PROPERTY STORAGE	5
18.07 REGULATION OF AIRCRAFT OPERATIONS.....	6
18.08 HEIGHT LIMITATION-AIRPORT APPROACH PROTECTION. SEE SECTION 2.05 OF THE ZONING ORDINANCE.....	7
18.09 ORDINANCE ENFORCEMENT.....	7

18.10 PENALTIES.....	7
CHAPTER XIX	1
KENOSHA MUNICIPAL HARBOR OPERATION AND REGULATIONS	1
19.01 BOARD OF HARBOR COMMISSIONERS	1
19.011 COMMERCIAL HARBOR, SIMMONS ISLAND MARINA, SAILBOAT BASIN, SOUTHPORT MARINA	1
19.015 MARINA COMMISSION	2
19.02 REGULATION OF BOATING	2
19.025 WATERWAYS DESIGNATED SLOW-NO-WAKE.....	3
19.03 PUBLICIZING LOCAL REGULATIONS	3
19.04 BULKHEAD LINE	3
19.045 PIERHEAD LINE, PENALTY FOR VIOLATIONS.....	4
19.05 LOCAL REGULATIONS	4
19.055 OBSTRUCTIONS TO NAVIGATION IN HARBOR	5
19.06 BOAT LAUNCHING AND MOORING IN THE SIMMONS ISLAND MARINA	6
19.07 SECRETARY.....	6
19.08 HARBOR MASTER	6
19.10 PENALTIES.....	7
CHAPTER XX	1
MANUFACTURED/MOBILE HOME PARK.....	1
20.01 DEFINITIONS.....	1
20.02 PARKING OUTSIDE LICENSED MANUFACTURED/MOBILE HOME PARK RESTRICTED.....	1
20.03 MANUFACTURED/MOBILE HOME PARK CONDITIONAL USE PERMIT.....	1
20.04 STANDARD REQUIREMENTS FOR MANUFACTURED/MOBILE HOME PARKS, ADDITIONS OR EXTENSIONS	3
20.05 MANUFACTURED/MOBILE HOME PARK OPERATORS LICENSE	4
20.06 BUILDING, ELECTRICAL, PLUMBING AND HVAC REQUIREMENTS	6
20.07 PROPERTY MAINTENANCE REQUIREMENTS.....	6
20.08 PENALTIES.....	8
CHAPTER XXI CONSUMER PROTECTION AND.....	1
WEIGHTS AND MEASURES.....	1
21.001 FEDERAL STANDARDS, STATE STATUTES AND RULES ADOPTED BY REFERENCE.....	1
21.01 MEANING OF TERMS	1
21.02 SYSTEMS OF WEIGHTS AND MEASURES.....	2
21.03 DEFINITIONS OF SPECIAL UNITS OF MEASURE	2
21.04 FIELD STANDARDS AND EQUIPMENT	2
21.05 GENERAL POWERS AND DUTIES OF SEALER.....	2
21.06 WEIGHING AND MEASURING DEVICE LICENSE	2
21.07 GENERAL TESTING	4
21.08 INVESTIGATIONS	4
21.09 INSPECTIONS OF PACKAGES.....	4

21.10 ENFORCEMENT AUTHORITY	4
21.11 VENDING MACHINES.....	5
21.12 METHOD OF SALE OF COMMODITIES.....	5
21.13 DECLARATION OF QUANTITY	6
21.14 DECLARATIONS OF UNIT PRICE ON RANDOM WEIGHT PACKAGES	6
21.15 MISLEADING PACKAGES	6
21.16 ADVERTISING COMMODITIES FOR SALE.....	6
21.17 BREAD.....	6
21.18 BULK DELIVERIES SOLD IN TERMS OF WEIGHT AND DELIVERED BY VEHICLE	6
21.19 HEATING OIL AND MOTOR FUEL	7
21.20 PROHIBITED ACTS	7
21.21 PRESUMPTIVE EVIDENCE	7
21.22 PENALTY	8
21.23 SEPARABILITY PROVISION.....	8
21.24 REPEAL OF CONFLICTING LAWS	8
21.25 CITATION.....	8
CHAPTER XXII	1
FAIR HOUSING	1
22.01 DECLARATION OF POLICY	1
22.02 DEFINITIONS.....	1
22.03 PROHIBITED ACTS	2
22.04 ACTS NOT PROHIBITED.....	2
22.05 ADMINISTRATION AND ENFORCEMENT	3
22.06 PENALTIES.....	3
22.07 SEVERABILITY	3
22.08 TITLE	4
CHAPTER XXIII NOISE CONTROL.....	1
23.1 FINDINGS AND DECLARATION OF POLICY.....	1
23.2 DEFINITIONS.....	1
23.3 ENFORCEMENT	3
23.4 EXCESSIVE NOISE DECLARED A NUISANCE.....	3
23.5 NOISE PROHIBITED.....	3
23.6 CRITERIA TO DETERMINE "NOISE"	4
23.7 METHOD OF MEASURING NOISE.....	5
23.8 VARIANCE PERMITS	5
23.9 EXEMPTIONS.....	6
23.10 CONTROL OF NIGHTTIME NOISES EMITTED BY RESIDENTIAL AIR CONDITIONERS	7
23.12 SOUND TRUCKS.....	7
23.13 CONTROL OF TRAFFIC NOISES.....	8
23.14 SALE, DISTRIBUTION, LEASE OR RENTAL OF NOISY EQUIPMENT	9

23.15 CITY CONTRACTS AND PURCHASES	9
23.16 SCHOOLS, HOSPITALS AND CHURCHES	10
23.17 APPEALS	10
23.18 INJUNCTION: ADDITIONAL REMEDY	10
23.19 PENALTY	10
23.20 SEVERABILITY	10
CHAPTER XXIV LANDLORD'S RIGHTS	1
24.01 LANDLORDS' RIGHTS.....	1
CHAPTER XXV	1
MINIMUM STANDARDS, REQUIREMENTS AND QUALIFICATIONS	1
FOR COMMERCIAL SERVICE OPERATORS AT THE KENOSHA REGIONAL AIRPORT	1
25.01 PURPOSE	1
25.02 DEFINITIONS.....	1
25.03 RIGHTS AND PRIVILEGES AT KENOSHA REGIONAL AIRPORT	2
25.04 PROHIBITION	3
25.05 REQUIREMENT	4
25.06 APPLICATION AND REVIEW OF QUALIFICATIONS OF POTENTIAL OPERATORS	4
25.07 MINIMUM STANDARDS FOR FIXED BASE OPERATOR.....	6
25.08 MINIMUM STANDARDS FOR AIRFRAME AND POWER PLANT OPERATOR	8
25.09 MINIMUM STANDARDS FOR AIRCRAFT RENTAL OPERATOR.....	9
25.10 MINIMUM STANDARDS FOR FLIGHT TRAINING OPERATOR.....	10
25.11 MINIMUM STANDARDS FOR AIRCRAFT FUEL DISPENSING OPERATOR.....	11
25.12 MINIMUM STANDARDS FOR SELF-FUELING OPERATOR.....	12
25.13 MINIMUM STANDARDS FOR AIRCRAFT CHARTER AND AIR TAXI OPERATOR.....	14
25.14 MINIMUM STANDARDS FOR AIR CARGO OPERATOR.....	15
25.15 MINIMUM STANDARDS FOR SCHEDULED AIR CARRIER OR SCHEDULED AIR CARGO OPERATOR	16
25.16 MINIMUM STANDARDS FOR SPECIALIZED COMMERCIAL FLYING OPERATOR.....	17
25.17 MINIMUM STANDARDS FOR SPECIALIZED AIRCRAFT REPAIR OPERATOR.....	19
25.18 MINIMUM STANDARDS FOR AIRCRAFT SALES OPERATOR	20
25.19 MINIMUM STANDARDS FOR MULTIPLE SERVICES OPERATOR	21
25.20 MINIMUM STANDARDS FOR T-HANGAR, COMMON HANGAR AND TIE-DOWN AIRCRAFT STORAGE OPERATOR.....	22
25.21 MINIMUM STANDARDS FOR FLYING CLUB OPERATOR	24
25.22 SHORT TERM PERMITS FOR OPERATORS OF OTHER COMMERCIAL AERONAUTICAL SERVICES	25
25.23 SEVERABILITY	25
25.24 PENALTIES.....	25
CHAPTER XXVI.....	1
KENOSHA CABLE TELEVISION.....	1
FRANCHISE ORDINANCE	1

26.01 SHORT TITLE 1

26.02 DEFINITIONS AND INTERPRETATION..... 1

26.03 FRANCHISE REQUIRED FOR CABLE SYSTEM/SERVICE 3

26.04 FRANCHISE AWARD..... 3

26.05 RIGHT AND PRIVILEGE OF GRANTEE IN STREETS..... 3

26.06 FRANCHISE APPLICABILITY AND ADMINISTRATION..... 3

26.07 FRANCHISE AGREEMENT AND TERM OF FRANCHISE 3

26.08 INITIAL FRANCHISE..... 3

26.09 FRANCHISE RENEWAL PROCESS 4

26.10 POLICE POWERS..... 4

26.11 USE OF GRANTEE FACILITIES BY CITY..... 5

26.12 COSTS OF AWARDING FRANCHISE 5

26.13 NOTICES UNDER FRANCHISE AGREEMENT 5

26.14 IRREVOCABLE LETTER OF CREDIT/CASH SECURITY DEPOSIT..... 5

26.15 CONSTRUCTION ASSURANCE 5

26.16 LIABILITY INSURANCE REQUIRED..... 5

26.17 NDEMNITY AND HOLD HARMLESS 6

26.18 DISCLAIMER OF LIABILITY..... 6

26.19 COMPLIANCE WITH LAW 6

26.20 CABLE SERVICE AVAILABILITY 7

26.21 CABLE SYSTEM CONSTRUCTION AND EXTENSION POLICY 7

26.22 CONSTRUCTION AND TECHNICAL PERFORMANCE STANDARDS 7

26.23 USE OF STREETS..... 7

26.24 OPERATIONAL STANDARDS 7

26.25 CONTINUITY OF CABLE SERVICE..... 8

26.26 CABLE SERVICE COMPLAINT PROCEDURE 8

26.27 GRANTEE RULES AND REGULATIONS..... 8

26.28 FRANCHISE FEE AND PEG ACCESS CHARGES AND COSTS 8

26.29 TRANSFER OF OWNERSHIP OR CONTROL 8

26.30 BOOKS, RECORDS AND REPORTS OF GRANTEE..... 8

26.31 CITY PROGRAMMING, SERVICE TO SCHOOLS AND GOVERNMENT BUILDINGS, AND PEG ACCESS 9

26.32 PERFORMANCE EVALUATION SESSIONS 9

26.33 RATE CHANGE PROCEDURES..... 9

26.34 FINANCIAL, CONTRACTUAL, SHAREHOLDER AND SYSTEM DISCLOSURE 9

26.35 FORECLOSURE AND RECEIVERSHIP..... 10

26.36 RIGHT OF ACQUISITION BY THE CITY..... 10

26.37 TERMINATION OF FRANCHISE FOR SUBSTANTIAL BREACH..... 10

26.38 REMOVAL OF CABLE SYSTEM INFRASTRUCTURE..... 11

26.39 THEFT OF CABLE SERVICE..... 11

26.40 LIQUIDATED DAMAGES	11
26.41 PENALTIES.....	11
CHAPTER XXVII.....	13
PUBLIC RECORDS AND PROPERTY.....	13
27.01 DECLARATION OF POLICY AND INTENT	13
27.02 CONSTRUCTION.....	13
27.03 SCOPE.....	13
27.04 DESTRUCTION OF RECORDS	13
27.05 DEFINITIONS.....	13
27.06 DEPUTY AND ALTERNATE CUSTODIANS OF PUBLIC RECORDS.....	14
27.07 RESPONSIBILITY OF CUSTODIAN	15
27.08 NOTICE AND FORM	16
27.085 CONFIDENTIALITY OF INCOME AND EXPENSE INFORMATION	18
27.09 ENFORCEMENT	18
27.10 AMENDMENTS AND REPEAL.....	18
27.11 SEVERABILITY	18
CHAPTER XXVIII VACANT BUILDING CODE.....	1
28.01 TITLE	1
28.02 PURPOSE.....	1
28.03 PUBLIC RECORD	1
28.04 RULES OF INTERPRETATION AND DEFINITIONS	1
28.05 APPLICABILITY	3
28.06 SEVERABILITY	4
28.07 CODE OFFICIAL.....	5
28.08 VACANT OR ABANDONED BUILDING OR STRUCTURE REQUIREMENTS.....	5
28.09 VACANT BUILDING PERMIT; INSPECTION; MAINTENANCE STANDARDS; FEES.....	6
28.10 BOARD OF HOUSING APPEALS.....	9
28.11 REINSPECTION FEES.....	9
28.12 PENALTIES.....	9
CHAPTER XXIX.....	1
STATEMENT OF ECONOMIC INTEREST.....	1
BY CITY OFFICERS, EMPLOYEES, CANDIDATES AND NOMINEES	1
29.01 DECLARATION OF POLICY	1
29.02 DEFINITIONS.....	1
29.03 STATEMENT OF ECONOMIC INTEREST REQUIRED.....	1
29.04 TIME FOR FILING.....	2
29.05 INCOMPLETE STATEMENT OF ECONOMIC INTEREST	2
29.06 PENALTY	2
CHAPTER XXX CODE OF ETHICS.....	1
30.01 PURPOSE.....	1

30.02 DEFINITIONS.....	1
30.03 POLICY	2
30.04 CONSTRUCTION.....	2
30.05 APPLICATION OF CODE.....	2
30.06 STANDARDS FOR ETHICAL CONDUCT	3
30.07 ENFORCEMENT	4
30.08 INVESTIGATION OF COMPLAINTS.....	4
30.09 DISCIPLINE	5
30.10 UNFOUNDED COMPLAINTS.....	5
30.11 SEVERABILITY	5
30.12 PENALTY	5
CHAPTER XXXI INCINERATION	1
CHAPTER XXXII.....	1
KENOSHA WATER UTILITY	1
WATER AND SEWERAGE SYSTEMS.....	1
32.01 DEFINITIONS.....	1
32.02 MANAGEMENT AND OPERATION OF WATER, SEWERAGE, AND HOUSEHOLD HAZARDOUS ..	9
WASTE	9
32.03 BOARD OF WATER COMMISSIONERS - Powers and Duties	9
32.04 GENERAL MANAGER	10
32.05 RULES AND REGULATIONS GOVERNING THE WATER UTILITY.....	10
32.06 RULES AND REGULATIONS GOVERNING THE WATER SYSTEM	13
32.07 RULES AND REGULATIONS GOVERNING THE SEWERAGE SYSTEM.....	25
32.08 WASTEWATER DISCHARGE REGULATIONS.....	29
32.09 PRIVATE WELLS	47
32.10 APPEAL	48
32.11 PENALTIES AND LEGAL REMEDIES	48
CHAPTER XXXIII.....	54
LAND-DISTURBING EROSION AND	54
SEDIMENT CONTROL ORDINANCE	54
33.01 AUTHORITY.....	54
33.02 FINDINGS AND PURPOSE.....	54
33.03 INTENT	54
33.04 APPLICABILITY OF CODE	54
33.05 INTERPRETATION	55
33.06 JURISDICTION AND ADMINISTRATION	55
33.07 DEFINITIONS.....	55
33.08 DESIGN CRITERIA, STANDARDS AND SPECIFICATIONS.....	57
33.09 PERFORMANCE STANDARDS.....	57
33.10 EROSION CONTROL PERMITS AND ADMINISTRATION.....	58

33.11 EROSION AND SEDIMENT CONTROL PLAN, STATEMENT AND AMENDMENTS	61
33.12 FEE SCHEDULE	63
33.13 INSPECTION.....	63
33.14 VIOLATIONS AND ENFORCEMENTS	63
33.15 APPEALS	65
33.16 SEVERABILITY	65
CHAPTER XXXIV.....	1
FORESTRY	1
34.01 INTENT AND PURPOSE	1
34.02 DEFINITIONS.....	1
34.03 CITY FORESTER.....	2
34.04 FORESTRY PERMIT.....	2
34.05 REGULATIONS RESPECTING TREES IN LAWN PARKS AND PUBLIC RIGHT-OF-WAYS	3
34.06 PUBLIC NUISANCE-PRIVATE PREMISES.....	5
34.07 PERMIT REVOCATION	6
34.08 NO GUARANTEE, WARRANTY OR CAUSES OF ACTION CREATED	6
34.09 NJURY TO TREES PROHIBITED	6
34.10 TREE PROTECTION.....	7
34.11 ENFORCEMENT	10
34.12 ADMINISTRATIVE REMEDIES	10
34.13 APPEALS	10
34.135 SPECIAL CHARGES.....	11
34.14 PENALTY	11
CHAPTER XXXV IMPACT FEES	1
35.01 PURPOSE.....	1
35.02 DEFINITIONS.....	1
35.03 PUBLIC FACILITIES NEEDASSESSMENT	2
35.04 FINDING OF REASONABLENESS AND STATUTORY COMPLIANCE	2
35.05 IMPACT FEE REDUCTION.....	2
35.07 PAYMENT OF IMPACT FEES.....	3
35.08 MPACT FEE REVENUES	3
35.09 TIME FOR USE OF IMPACT FEES.....	3
35.10 IMPACT FEES.....	3
35.11 APPEAL	4
CHAPTER XXXVI.....	1
POST-CONSTRUCTION	1
STORMWATER MANAGEMENT ORDINANCE.....	1
36.01 AUTHORITY.....	1
36.02 FINDINGS AND PURPOSE.....	1
36.03 INTENT	2

36.04 APPLICABILITY OF CODE	2
36.05 DEFINITIONS.....	2
36.06 TECHNICAL STANDARDS	6
36.07 PERFORMANCE STANDARDS.....	7
36.08 PERMIT REQUIREMENTS; PROCEDURES AND FEES	11
36.09 STORMWATER MANAGEMENT PLAN	13
36.10 MAINTENANCE	15
36.11 FINANCIAL GUARANTEE.....	15
36.12 FEE SCHEDULE	16
36.13 ENFORCEMENT	16
36.14 APPEALS	17
CHAPTER XXXVII.....	1
ILLICIT STORMWATER DISCHARGES AND CONNECTIONS	1
37.01 AUTHORITY.....	1
37.02 FINDINGS AND PURPOSE.....	1
37.03 ADMINISTRATION.....	2
37.04 APPLICABILITY OF CODE	2
36.05 DEFINITIONS.....	2
37.06 PROHIBITIONS.....	4
37.07 SUSPENSION OF ILLICIT DISCHARGES	4
37.08 MONITORING	5
37.09 PREVENTION WITH BMPS	6
37.10 NOTIFICATION OF SPILLS	6
37.11 ENFORCEMENT	6
37.12 APPEAL	7
37.13 SEVERABILITY	8
CHAPTER XXXVIII.....	1
KENOSHA HERITAGE	1
38.01 PRESERVATION OF HISTORICAL ARTIFACTS.....	1

CHAPTER I
CITY GOVERNMENT

1.01 COMMON COUNCIL

A. Composition. The Common Council of the City of Kenosha shall be composed of the Mayor and seventeen (17) Alderpersons. One (1) Alderperson shall be elected from each of the seventeen (17) Districts of the City for the term of two (2) years on the first Tuesday of April in even numbered years commencing with April 1, 1958, or on such other date determined by State law, rule or regulation.

B. Duties of Alderpersons.

1. Mandatory Responsibility. In addition to the responsibilities imposed by the Wisconsin Statutes or by the Common Law, each Alderperson shall:

a. Unless excused for particular meetings of the Common Council, attend each duly scheduled regular or special meeting of the Common Council.

b. Unless excused for particular meetings of the Committee to which the Alderperson is appointed, attend each duly scheduled regular or special meeting of the Committee.

c. Unless excused for particular meetings of the Commission or Board to which the Alderperson is appointed, attend each duly scheduled regular or special meeting of the Commission or Board.

2. Constituent Contact. It is encouraged that each Alderperson every calendar month provide an eight (8) hour period of service availability to constituents, which eight (8) hour period will be exclusive of any other responsibilities; said service availability may be provided through public concourse, including, but not limited to, listening sessions, in-home constituent visits, or attendance at an aldermanic office.

3. Absences.

a. Excused. Any Alderperson who will be absent from a meeting to which the Alderperson is responsible to attend, shall have the obligation of contacting the presiding officer of that body. If the presiding officer excuses the Alderperson, at the initiation of the meeting, after the roll call, the presiding officer shall cause the Clerk to note for the minutes that the Alderperson is excused. Any member of the body may object to the excused nature of the absence; in the event of an objection, the excused nature of the absence shall be put to a vote of the body. A majority of those of the body in attendance is required to sustain the objection.

b. Unexcused. In the event that an absence is deemed unexcused, whether by inability of the Alderperson to contact the presiding officer in advance of the meeting, the refusal of the presiding officer to excuse the absence, or sustained objection by the body, the Alderperson may appeal the unexcused nature of the absence to the body at the next meeting attended by the Alderperson. Notice of such appeal shall be made in a sufficient time to enable it to be placed on an agenda in due course. Such appeal need not be in writing. Such appeal will not be in the nature of reconsideration. Such appeal will be granted and the absence(s) excused by a majority vote of those of the body in attendance.

C. Compensation.

1. Monthly Salary. Each Alderperson shall be paid a salary of Four Thousand One Hundred (\$4,100) Dollars per Annum commencing on the third Tuesday of April, 1992. Commencing on the third Tuesday of April, 1996, each Alderperson shall be paid a salary of Five Thousand One Hundred (\$5,100) Dollars per annum. Commencing on the third Tuesday of April, 1998, each Alderperson shall be paid a salary of Five Thousand Five Hundred (\$5,500) Dollars per annum. Commencing on the third Tuesday of April, 2016, each Alderperson shall be paid a salary of Six Thousand (\$6,000) Dollars per annum.

2. Per Diem Allowance. In addition to the salary in Paragraph C.1., each Alderperson shall receive the following compensation:

a. A Per Diem of Fifty (\$50) Dollars for each day he/she is absent from the City at the direction of the Common Council or of the Mayor, together with all travel, meals and out-of-pocket expenses incurred therewith.

Effective January 1, 1983, said per diem shall be One Hundred (\$100) Dollars per full day (six hours or more in attendance) and Fifty (\$50) Dollars for less than a full day (two hours or more in attendance).

CODE OF GENERAL ORDINANCES, 2021 - KENOSHA, WISCONSIN

b. A Per Diem of Fifty (\$50) Dollars for each day for attendance at any meeting of the Common Council, or a Committee thereof, or for attendance at any other meeting or conference approved in advance by the Mayor held on Monday through Friday between the hours of 8:00 A.M. and 4:00 P.M.

Effective January 1, 1983, said per diem shall be One Hundred (\$100) Dollars per full day (six hours or more in attendance) and Fifty (\$50) Dollars for less than a full day (two hours or more in attendance).

c. A Per Diem of One Hundred (\$100) Dollars for each day for any Alderperson who performs the duties of "Acting Mayor".

d. The Mayor is authorized to reject Per Diem claims when in his/her opinion he/she believes that only a nominal amount of time was worked on a given day, causing no financial loss to an Alderperson or when he/she believes that the time worked by an Alderperson forming the basis for a Per Diem claim was unauthorized or unnecessary. The decision of the Mayor may be appealed by an Alderperson to the Common Council.

e. Alderpersons who are not covered by or eligible for an employer provided Plan or policy of insurance providing for hospital, surgical and major medical benefits are eligible for coverage under the City's hospital, surgical and major medical plan or policy of insurance, the full premium thereof to be paid by said Alderperson, provided that the Alderperson requesting said City plan or policy make proper application therefor, be eligible under the terms of the plan or policy, take any physical examinations which may be required and abide by any waiting period which may be applicable.

f. A One Hundred (\$100.00) Dollar per month expense allowance to cover in-City mileage, meals and miscellaneous expenses, effective January 1, 2001.

D. Aldermanic Districts.

1. District Boundaries. The City of Kenosha, Wisconsin, shall be, and is hereby divided into seventeen (17) Districts, each of which District shall consist of contiguous whole wards as created in Resolution No. 39-12, adopted by the Common Council of the City of Kenosha, Wisconsin, on March 5, 2012, as follows:

a. **First District** shall consist of that part of the City of Kenosha contained in Ward One (1), Ward Two (2), Ward Three (3), Ward Four (4), Ward Eighty (80), and Ward Ninety-Eight (98);

b. **Second District** shall consist of that part of the City of Kenosha contained in Ward Five (5), Ward Six (6), Ward Seven (7) and Ward Eight (8);

c. **Third District** shall consist of that part of the City of Kenosha contained in Ward Nine (9), Ward Ten (10), Ward Eleven (11) and Ward Twelve (12);

d. **Fourth District** shall consist of that part of the City of Kenosha contained in Ward Thirteen (13), Ward Fourteen (14), Ward Fifteen (15), Ward Sixteen (16), Ward Nineteen (19), Ward Ninety-Six (96), Ward Ninety-Nine (99), and Ward One Hundred Twelve (112), and Ward One Hundred Eighteen (118);

e. **Fifth District** shall consist of that part of the City of Kenosha contained in Ward Seventeen (17), Ward Eighteen (18), Ward Twenty (20), Ward Twenty-One (21), Ward Twenty-Two (22), Ward Ninety-Two (92), Ward Ninety-Four (94), Ward One Hundred and One (101), and Ward One Hundred and Five (105);

f. **Sixth District** shall consist of that part of the City of Kenosha contained in Ward Twenty-Three (23), Ward Twenty-Four (24), Ward Twenty-Five (25), Ward Twenty-Six (26), Ward Eighty-One (81), and Ward One Hundred Sixteen (116);

g. **Seventh District** shall consist of that part of the City of Kenosha contained in Ward Twenty-Seven (27), Ward Twenty-Eight (28), Ward Twenty-Nine (29) and Ward Thirty (30);

h. **Eighth District** shall consist of that part of the City of Kenosha contained in Ward Thirty-One (31), Ward Thirty-Two (32), Ward Thirty-Three (33), Ward Thirty-Four (34) and Ward Thirty-Five (35);

i. **Ninth District** shall consist of that part of the City of Kenosha contained in Ward Forty (40), Ward Forty-One (41), Ward Forty-Two (42), Ward Forty-Three (43) and Ward Forty-Four (44);

j. **Tenth District** shall consist of that part of the City of Kenosha contained in Ward Forty-Five (45), Ward Forty-Six (46), Ward Forty-Seven (47), Ward Forty-Eight (48), Ward Forty-Nine (49), Ward Eighty-Two (82), Ward Eighty-Three (83), Ward One Hundred Six (106) and Ward One Hundred Fourteen (114);

k. **Eleventh District** shall consist of that part of the City of Kenosha contained in Ward Fifty (50), Ward Fifty-One (51) and Ward Fifty-Two (52), Ward Fifty-Three (53), Ward Eighty-Four (84) and Ward Eighty-Five (85);

l. **Twelfth District** shall consist of that part of the City of Kenosha contained in Ward Thirty-Six (36), Ward Thirty-Seven (37), Ward Thirty-Eight (38) and Ward Thirty-Nine (39);

m. **Thirteenth District** shall consist of that part of the City of Kenosha contained in Ward Fifty-Nine (59), Ward Sixty (60), Ward Sixty-One (61) and Ward Sixty-Two (62);

n. **Fourteenth District** shall consist of that part of the City of Kenosha contained in Ward Sixty-Three

CODE OF GENERAL ORDINANCES, 2021 - KENOSHA, WISCONSIN

(63), Ward Sixty-Four (64), Ward Sixty-Five (65), Ward Sixty-Six (66) and Ward Sixty-Seven (67);

o. Fifteenth District shall consist of that part of the City of Kenosha contained in Ward Fifty-Four (54), Ward Fifty-Five (55), Ward Fifty-Six (56), Ward Fifty-Seven (57), Ward Fifty-Eight (58), Ward Eighty-Six (86) and Ward Eighty-Seven (87);

p. Sixteenth District shall consist of that part of the City of Kenosha contained in Ward Sixty-Eight (68), Ward Sixty-Nine (69), Ward Seventy (70), Ward Seventy-One (71), Ward Seventy-Two (72), Ward Seventy-Three (73), Ward Seventy-Four (74), Ward Seventy-Five (75), Ward Eighty-Eight (88), Ward Eighty-Nine (89), Ward Ninety (90), and Ward Ninety-One (91), Ward Ninety-Five (95), Ward Ninety-Seven (97), Ward One Hundred Two (102), Ward One Hundred Three (103) and Ward One Hundred Four (104), Ward One Hundred Seven (107), Ward One Hundred Eight (108), Ward One Hundred Ten (110), Ward One Hundred Eleven (111), Ward One Hundred Thirteen (113), Ward One Hundred Fifteen (115) and Ward One Hundred Seventeen (117);

q. Seventeenth District shall consist of that part of the City of Kenosha contained in Ward Seventy-Six (76), Ward Seventy-Seven (77), Ward Seventy-Eight (78), Ward Seventy-Nine (79), Ward Ninety-Three (93), Ward One Hundred (100) and Ward One Hundred Nine (109).

2. District Map. A map depicting the aforesaid Ward and District boundary lines is on file in the Office of the City Clerk/Treasurer, Kenosha, Wisconsin.

1.012 CODE OF GENERAL [GENERAL AND ZONING] ORDINANCES

A. Definitions.

1. General Ordinances shall mean and include the General and the Zoning Ordinances of the City of Kenosha, Wisconsin.

2. Codify/Codification shall mean and include:

a. Compiling existing laws, their systematic arrangement into chapters or articles and sections, with subheads, table of contents, and index for ready reference.

b. Revising existing laws as to harmonize conflicts, supply omissions, and generally clarify and make complete the relevant body of laws.

c. Renumbering, correcting of typographical errors, correcting gender of and plurality of words, and correcting of erroneous references or cross-references.

d. Eliminating inconsistencies and surplusage.

B. Authority. This Ordinance is adopted under authority of Section 66.0103, Wisconsin Statutes.

C. Drafting. All ordinances and ordinance proposals must either be drafted by the City Attorney's Office or if not drafted by the City Attorney, forwarded to the City Clerk and the City Attorney within twenty-four (24) hours of referral from Common Council or placement onto an agenda to be approved by the City Attorney's Office as to format and reviewed for content and legality. The Principal Sponsor directs and has final approval for all proposed ordinance language.

D. Codification. The City Attorney's Office, at least once each calendar year, shall codify the General Ordinances of the City of Kenosha into two (2) separate publications. One publication shall be known as the General Ordinances of the City of Kenosha, Wisconsin. The other publication shall be known as the Zoning Ordinance of the City of Kenosha, Wisconsin.

Upon codification of the General Ordinances, said publication shall be submitted to the City Clerk's Office for printing and sale to the general public for a charge sufficient to cover the cost of printing and distribution. Copies shall be provided to City officers and departments without charge. Complimentary copies may be provided to the various branches of the Circuit Court and other units of government.

Upon codification of the Zoning Ordinance, said publication shall be submitted to the Department of City Development for printing and sale to the general public for a charge sufficient to cover the cost of printing and distribution. Copies shall be provided to City officers and departments without charge. Complimentary copies may be provided to the various branches of the Circuit Court and other units of government.

The codification of General Ordinances is not required to be enacted by the Common Council as new legislation or published by the City Clerk's Office as an Ordinance.

CODE OF GENERAL ORDINANCES, 2021 - KENOSHA, WISCONSIN

The codification of General Ordinances [General and Zoning Ordinances], which were on file in the office of the City Clerk for not less than two (2) weeks prior to the adoption of this Ordinance is adopted by reference. Any Ordinances, whether General or Zoning, which are adopted in the future, may be codified as provided herein without further action by the Common Council.

E. Inspection. A copy of the Code of General Ordinances and Zoning Ordinance shall be permanently on file and open to public inspection in the office of the City Clerk. The general public may obtain a copy of any portion thereof upon payment of a per page charge sufficient to cover the cost of printing and distribution.

1.015 ALDERMANIC VACANCIES-HOW FILLED

Whenever a vacancy, as defined in §17.03, Wisconsin Statutes, occurs in an aldermanic position, one of the following procedures shall be followed:

A. Notice of Vacancy. Notice of the vacancy of an aldermanic position shall be declared at the first Council meeting following a vacancy.

B. Appointment.

1. Within thirty (30) days after the first Council meeting following a vacancy, notice of said vacancy shall be given by the City Clerk to the residents of said aldermanic ward by such means as will fairly and adequately notify interested persons of the vacancy and of the procedures to be followed in applying for said vacant position.

2. The notice shall advise potential applicants that the application must state:

a. That the applicant is an elector of the ward. This fact will be verified by the City Clerk and the application will be rejected if the applicant is not an elector of the ward in which the vacancy occurred.

b. The applicant's name, address, phone number, occupation, place of employment, general background information, and reasons for applying for position.

c. That the application must be submitted to the City Clerk by a date certain, which date shall be within fifteen (15) days of the date of said notice.

d. That on the Council meeting following the expiration of the fifteen (15) days above specified, the Common Council will fill the vacancy. The applicant, where possible, should appear in person before the Council and be prepared to answer any questions which may be asked relative to the applicant's qualifications for said office.

3. The Common Council will fill the vacancy by a majority vote of those members in attendance. All applicants who are electors of the ward in which the vacancy occurred, shall be deemed nominees for said position. The Council shall openly vote, as many times as necessary, eliminating all but two, or more in the event of a tie, applicants. In the event of a tie vote, which results in three (3) or more finalists the Common Council shall take a separate vote to break the tie in which only the tied applicants shall be voted upon. If the tie is still unbroken after such separate vote, the Mayor shall vote to break the tie. The applicant of the top two (2) who receives a majority vote shall be appointed to fill the vacancy. If, at any time in the election process, one (1) applicant shall receive a majority vote, the election shall be deemed completed and the applicant receiving the majority vote shall be appointed to the vacancy.

4. The applicant appointed to fill the vacancy shall be sworn in on the date of appointment, but shall not vote on any issue before the Council on the date of appointment.

C. Special Election. The Council, where authorized by the Wisconsin Statutes, by a majority of those present, may, on the first Council meeting following a vacancy, elect to follow the alternative procedure of holding a special election, which election would be ordered as soon as possible, pursuant to the procedures and time frames therefor in the Wisconsin Statutes, as they are interpreted by the Office of the State Elections Commission.

1.016 MAYORAL VACANCY-HOW FILLED

Whenever a vacancy, as defined in §17.03 Wisconsin Statutes, occurs in the position of Mayor, one of the following procedures shall be followed:

CODE OF GENERAL ORDINANCES, 2021 - KENOSHA, WISCONSIN

A. Notice of Vacancy. Notice of the vacancy in the position of Mayor shall be declared at the first Council meeting following a vacancy.

B. Appointment.

1. Within thirty (30) days after the first Council meeting following a vacancy, notice of said vacancy shall be given by the City Clerk to the residents of the City by such means as will fairly and adequately notify interested persons of the vacancy and of the procedures to be followed in applying for said vacant position.

2. The notice shall advise potential applicants that the application must state:

a. That the applicant is an elector of the City. This fact will be verified by the City Clerk and the application will be rejected if the applicant is not an elector of the City.

b. The applicant's name, address, phone number, occupation, place of employment, general background information, and reasons for applying for position.

c. That the application must be submitted to the City Clerk by a date certain, which date shall be within fifteen (15) days of the date of said notice.

d. That on the Council meeting following the expiration of the fifteen (15) days above specified, the Common Council will fill the vacancy. The applicant, where possible, should appear in person before the Council and be prepared to answer any questions which may be asked relative to the applicant's qualifications for said office.

3. The Common Council will fill the vacancy by a majority vote of those members in attendance. All applicants who are electors of the City shall be deemed nominees for said position. The Council shall openly vote, as many times as necessary, eliminating all but two, or more in the event of a tie, applicants. In the event of a tie vote, which results in three (3) or more finalists, the Common Council shall take a separate vote to break the tie in which only the tied applicants shall be voted upon. If the tie is still unbroken after such separate vote, the Common Council shall vote to break the tie. The applicant of the top two (2) who receives a majority vote shall be appointed to fill the vacancy. If, at any time in the election process, one (1) applicant shall receive a majority vote, the election shall be deemed completed and the applicant receiving the majority vote shall be appointed to the vacancy.

4. The applicant appointed to fill the vacancy shall be sworn in on the date of appointment, but shall not preside over the Council on the date of appointment.

C. Special Election. The Council, where authorized by the Wisconsin Statutes, by a majority of those present, may, on the first Council meeting following a vacancy, elect to follow the alternative procedure of holding a special election, which election would be ordered as soon as possible, pursuant to the procedures and time frames therefor in the Wisconsin Statutes, as they are interpreted by the Office of the State Elections Commission.

1.02 MEETINGS OF THE COMMON COUNCIL

A. Organization Meeting. Following a regular City election for the purpose of organization, the Common Council shall meet on the third Tuesday in April in the Council Chambers in the Kenosha Municipal Building at 7:30 P.M.

B. Regular Meetings. Regular meetings of the Common Council shall be held on the first and third Monday evenings of each calendar month at the hour of 7:00 P.M. in the Kenosha Municipal Building, 625 - 52nd Street in such room as the Common Council shall designate. Any regular meeting falling upon a legal holiday including: January 1, the third Monday in January, which shall be the day of celebration for January 15, the third Monday in February, which shall be the day of celebration for February 12 and 22, July 4, the first Monday in September and the day following if January 1 or July 4 falls on a Sunday, shall be held on the next following Wednesday at the same hour and usual place. Public notice of all regular meetings shall be given as provided in Subchapter V of Chapter 19, Wisconsin Statutes.

C. Special Meetings. Special meetings may be called by the Mayor upon written notice of the time and purpose thereof to each member of the Council delivered to him personally or left at his usual place of abode at least six (6) hours before the meeting. The Clerk shall cause an affidavit of service of such notice

CODE OF GENERAL ORDINANCES, 2021 - KENOSHA, WISCONSIN

to be filed in his office prior to the time fixed for such special meeting. Public notice of all special meetings shall be given as provided in Subchapter V of Chapter 19 Wisconsin Statutes.

No business shall be transacted or action taken at any special meeting other than that germane to the purpose stated in the notice given by the Mayor or consented to in writing by all members of the Common Council.

A special meeting also may be called upon written request to the City Clerk stating the purpose and time of said proposed meeting and signed by at least seven (7) aldermen. Upon receipt of such written request the City Clerk shall give written notice of the time, place, and purpose of such meeting to each member of the Council and to the Mayor by delivering such notice at each of their usual places of abode at least six (6) hours before the meeting. The Clerk shall cause an affidavit of service of such notice to be filed in his office prior to the time for such special meeting.

D. Quorum and Adjournment.

1. Twelve (12) Aldermen of the Common Council shall constitute a quorum. No action shall be taken by the Common Council unless a quorum is present.

2. The Council may, by a majority vote of those present, but not less than nine (9) affirmative votes, adjourn from time to time to a specific date and hour.

3. No regular meeting shall extend beyond 11:30 P.M., except that the matter then on the floor shall be continued to conclusion, at which time the meeting shall be adjourned to the following day to complete the agenda. Notwithstanding the above, regular meetings of the Common Council may be extended beyond 11:30 P.M. by consent of twelve (12) members. However, a motion to adjourn is in order at any time after 11:30 P.M. which may be passed by majority vote of members present.

E. Closed Sessions. No closed session shall be held by the Common Council, Committee, Commission or Board of the City of Kenosha without first complying with all the provisions of the Open Meeting Law.

F. Veto. The Mayor shall have the veto power as to all acts of the Council, except such as to which it is expressly or by necessary implication otherwise provided. All such acts shall be submitted to the Mayor by the Clerk and shall be in force upon approval evidenced by the Mayor's signature, or upon failing to approve or disapprove within 5 days, which fact shall be certified thereon by the clerk. If the Mayor disapproves the Mayor's objections shall be filed with the Clerk, who shall present them to the Council at its next meeting. A vote of twelve (12) members of the Council shall then make the act effective notwithstanding the objections of the Mayor.

1.025 DRESS CODE FOR MEMBERS OF THE COMMON COUNCIL

A. Purpose. The purpose of this Ordinance is to create a dignified and professional environment for the Council meetings which will be reflected in news media coverage thereof.

B. Definitions.

1. **"Proper Attire"** shall mean, with respect to male members, a suit or sportcoat and dress pants worn with a collared shirt or banded collar shirt. The wearing of a tie is optional.

2. **"Proper Attire"** shall mean, with respect to female members, a dress, pantsuit, skirt with a sweater or blouse, or blazer with dress slacks. The term **"proper attire"** shall also mean that clothing shall be clean, neat and pressed.

3. **"Business Casual"** attire shall mean with respect to male members, a combination of collared shirt (such as a dress shirt or polo shirt) and cotton trousers (such as khakis or blue, green, brown, or black trousers). With respect to female members, a reasonable length skirt or full-length slacks of a material other than denim combined with a top (such as a dress shirt, polo, or sweater set) is considered acceptable.

CODE OF GENERAL ORDINANCES, 2021 - KENOSHA, WISCONSIN

C. Requirement. All members of the Common Council shall wear proper attire to all regular meetings of the Common Council and Committee of the Whole meetings. Business casual is optional attire for regular meetings of the Common Council and for meetings of the Committee of the Whole, during the months of June, July, August, and September. During committee meetings of the Finance Committee, Public Works Committee, Board of Water Commissioners, Storm Water Utility Committee, Public Safety and Welfare Committee, Board of Park Commissioners, and License and Permit Committee, business casual attire shall be worn.

D. Exception. The Common Council, by motion and for good cause, may suspend this rule for a particular meeting for the entire Common Council or for any member or members thereof which a majority vote shall be required.

E. Penalty. If a member fails to comply with this ordinance or a majority of the Common Council does not vote to allow the suspension of the rule, those members found not to be in compliance, will be barred for the entirety of that particular Common Council meeting, Committee of the Whole meeting or committee, commission, or board meeting specified in subsection D. above, or until such time as they be found to be in compliance with this ordinance.

1.027 FACE COVERINGS FOR MEMBERS OF THE COMMON COUNCIL

Findings and Purpose.

A. Findings.

1. The United States of America, the State of Wisconsin, and the City of Kenosha have been affected by the worldwide pandemic of the novel coronavirus disease (COVID-19), which is a dangerous respiratory illness that can spread from person to person.

2. That the Common Council by Resolution 49-20, declared a state of emergency in the City of Kenosha due to the existence of COVID-19 in the city pursuant to its authority under Wis. Stats. Sections 323.11 and 323.14.

3. The World Health Organization ("WHO") has indicated that COVID-19 is spread primarily by respiratory droplets produced when an infected person coughs or sneezes and droplets can also be generated by talking, laughing, or exhaling.

4. The Center for Disease Control ("CDC") has stated that people experiencing no symptoms can spread COVID-19 more widely than previously thought, and that people are the most contagious before they start showing symptoms.

5. On April 3, 2020, the CDC issued a recommendation for individuals to wear cloth face coverings in public settings where other social distancing measures are difficult to maintain.

6. On April 10, 2020, the U.S. Surgeon General recommended that individuals wear face coverings because he concluded that there is a significant amount of asymptomatic spread of COVID-19.

7. The Director of the National Institute of Allergy and Infectious Diseases has recommended that individuals wear facial coverings to prevent individuals from infecting others.

8. City Administration has directed City employees while attending public meetings to protect other attendees from COVID-19 by wearing face coverings.

B. Purpose. The City of Kenosha pursuant to the emergency powers authorized by sections 323.11 and 323.14 requires face coverings to be worn by members of the Council during meetings in order to protect, preserve and promote the general health, safety and welfare of the public and slow the spread of COVID-19.

C. Requirement. All members of the Common Council, who can medically tolerate a face covering, shall wear a face covering to all regular meetings of the Common Council, Committee of the Whole meetings, meetings of the Finance Committee, Public Works Committee, Board of Water Commissioners, Storm Water Utility Committee, Public Safety and Welfare Committee, Board of Park Commissioners, and License and Permit Committee. Face

CODE OF GENERAL ORDINANCES, 2021 - KENOSHA, WISCONSIN

Covering as used herein is a device to cover the nose and mouth of a person to impede the spread of saliva or other fluids during speaking, coughing, sneezing or other intentional or involuntary action. Medical grade masks are not required; coverings may be fashioned from scarves, bandannas or other suitable fabrics. The mask must cover the mouth and nose of the wearer.

D. Exception. The Common Council, by motion and for good cause, may suspend this rule for a particular meeting for the entire Common Council or for any member or members thereof which a majority vote shall be required.

E. Sunset. This requirement will expire on November 19, 2020 unless it is otherwise extended, terminated or otherwise modified by the Common Council.

F. Penalty. If a member fails to comply with this ordinance or a majority of the Common Council does not vote to allow the suspension of the rule, those members found not to be in compliance, will be barred for the entirety of that particular Common Council meeting, Committee of the Whole meeting or committee, commission, or board meeting specified in subsection D. above, or until such time as they be found to be in compliance with this ordinance.

1.03 RULES OF COUNCIL

A. Order of Business. The order of business of the Common Council is not subject to change through a motion to suspend the rules, with the exception of subparagraph 1.03 A.9.a. The business of the Council shall be conducted in the following order:

1. Call to order by presiding Officer.
2. Roll Call. If a quorum is not present, the meeting shall thereupon be adjourned to a specific date and hour.
3. Invocation.
4. Pledge of Allegiance.
5. Approval of the minutes, subject to corrections, of the previous meeting and of any other regular or special meeting where the minutes have not been approved.
6. Non-Agenda matters referred to Committees, Boards, Commissions and authorities by the Mayor.
7. Presentations, Commendations and Awards by Mayor.
8. Awards and commendations from Boards, Commissions, Authorities and Committees.
9. **Citizen's Comments.**

a. Maximum Total Time Limit: Sixty (60) minutes for all speakers. The Common Council by a majority vote of the members present, may extend the time period by thirty (30) minute increments to permit speakers who have signed up pursuant to subparagraph 9.c., an opportunity to speak; each thirty (30) minute increment extension requires a separate vote.

b. Maximum Individual Time Limit: Three (3) minutes for each individual speaker, with no extension or use of another person's time. In the event that the number of speakers who have signed up pursuant to subparagraph 9.c. is less than or equal to twelve (12), the time limit of the previous sentence is extended to five (5) minutes. The City Clerk/Treasurer must announce the total number of speakers who have signed up to speak.

CODE OF GENERAL ORDINANCES, 2021 - KENOSHA, WISCONSIN

c. Speaker Sign-Up: Speakers must personally sign in with the City Clerk/Treasurer or his/her designee between 6:30 P.M. and 7:00 P.M., prior to commencement of the Common Council meeting and provide their home address, including city, village or town. No one will be permitted to sign up on behalf of another person unless that person, due to disability or other physical infirmity, is unable to sign for themselves. Only speakers who are timely signed in will be permitted to speak. The City Clerk/Treasurer, during Citizen's Comments, will call speakers forward.

d. Rules: Citizens are bound by the same rules as the Common Council, with particular reference to "Decorum in Debate", per Robert's Rules of Order, revised.

e. Public Hearings: §1.03.F.3.c. of the Code of General Ordinances shall remain applicable to Citizen's Comments on agenda items.

10. Economic Development Reports and other presentations authorized by the Mayor.
11. Agenda matters referred to Committees, Boards, Commissions and Authorities.
12. Communications, Petitions, and Reports of Departments.
13. Reports and recommendations from the Committee on Licenses/Permits.
14. Reports and recommendations of Boards and Commissions
15. General Ordinances, first reading.
16. Zoning Ordinances, first reading.
17. General Ordinances, second reading.
18. Zoning Ordinances, second reading.
19. Resolutions.
20. Appointments/Reappointments by the Mayor.
21. Public construction and improvement contracts.
22. Other contracts and agreements.
23. Reports and recommendations from Committee on Finance.
24. Reports and recommendations from the Committee on Public Works.
25. Reports and recommendations from the Committee on Public Safety and Welfare.
26. Such other matters as are authorized by law or regular business.
27. Legislative report.
28. Mayor's comments.
29. Alderpersons' comments

The Mayor shall appoint one (1) or more members of the City Clerk's Office to read the Agenda, take minutes and conduct roll calls at meetings of the Common Council.

B. Agenda Creation

1. The Mayor is responsible for the creation of the Common Council agenda. The Mayor may delegate ministerial acts associated therewith to the City Clerk.

2. Subject to exceptions in paragraph B.3., no item may be placed on the Common Council agenda without the approval of the Mayor.

3. Subject to compliance with applicable law, including, but not limited to the Wisconsin Open Meetings Law, the following will be placed on the next available Common Council regular meeting agenda:

a. the report of a committee, commission, board, or authority when the report is on an item that was referred solely to that committee, commission, board, or authority by the Common Council;

b. the reports of the committees, commissions, boards, and/or authorities to which an item was referred by the Common Council after the last reporting committee, commission, board, or authority has made its recommendation to the Common Council;

c. consideration for action of an item referred by the Common Council to one or more committees, commissions, boards, and/or authorities for which full reports have not been made but for which the time for reporting provided in subparagraph 1.03 D.5.b. has expired;

d. the report of a committee, commission, board, or authority of an item under its jurisdiction, the consideration of which was initiated in the committee, commission, board, or authority;

e. the agenda items proposed by at least seven alderpersons calling for a special meeting pursuant to Subsection 1.02 C; and

f. an agenda item for referral to an appropriate committee, commission, board, or authority or combination thereof given by an alderperson to the Clerk by noon on the Friday before the Common Council meeting.

g. an oral referral shall be made by the presiding officer to the appropriate committee, commission, board, or authority or combination thereof if prior to the completion of the referral item on the agenda pursuant to paragraph 1.03 A.11, an alderperson provides to the presiding officer in writing an item for referral.

4. The Mayor will cause the description of items placed on the Common Council agenda pursuant to subparagraphs 3. a., b., c., or d. to be worded to allow the Common Council to take final action.

C. Presiding Officer. The Mayor at the stated hour shall call the meeting to order. He/she shall preserve order and decorum, decide all questions of order and conduct the proceedings of the meeting in accordance with the parliamentary rules contained in Robert's Rules of Order Revised, unless otherwise provided by statute or by these rules. Any member shall have the right of appeal from a decision of the presiding officer. The appeal may be sustained by a majority of the members present, exclusive of the presiding officer.

If the Mayor is absent at the designated time of any meeting, the President of the Council shall preside, and during the absence or inability of the Mayor, shall have the powers and duties of the Mayor excepting that he/she shall not have the power to approve an act of the Council which the Mayor has disapproved by filing an objection with the Clerk. He/she shall, when so officiating, be styled "Acting Mayor". The President shall have a one (1) year term. The President shall be eligible to serve two (2) consecutive terms. The President shall be elected by the Common Council at the organizational meeting on the third Tuesday of April following a regular City Election; and, in off-election years, the President shall be appointed at the second regular meeting during the month of April. Election may be by secret ballot upon a request of a nominated candidate. If the nominated candidate requests a secret ballot, the clerk shall be responsible for counting the votes.

In the event of a declared "State of Emergency", covered under §1.14 of the Code of General Ordinances, in which the Mayor and President of the Common Council are unable to serve, the persons holding the following offices shall perform the duties of the Mayor during such declared emergency in the following order: Chairman of the Committee on Finance; Chairman of the Committee on Public Works; and Chairman of the Committee on Public Safety & Welfare.

Whenever the presiding officer shall desire to speak upon any question, or to make any motion, he/she shall vacate the chair and designate the president of the Council, if present, and if not, any

alderman to preside temporarily.

The Mayor shall not vote except in the case of a tie. When the Mayor does vote in case of a tie, his/her vote shall be counted in determining whether a sufficient number of the Council has voted favorably or unfavorably on any measure.

D. Committees of Council.

1. The Committees on Finance, Public Works (Board of Public Works), Public Safety and Welfare, Stormwater Utility, and Licenses/Permits shall be appointed by the Mayor and confirmed by a majority vote of the members present at the organizational meeting of the newly elected Council on the third Tuesday of April, or as soon thereafter as may be possible.

a. Committee on Finance. The Common Council shall take no final action on the following matters unless the same have been referred to the Committee on Finance and that Committee has given its written advice thereon:

Approval of any or all vouchers.

Approval of purchase or sale of land or buildings.

Approval of funds transferred between accounts.

Approval of all bond issues.

Approval of all Resolutions which require the levying of special taxes or the deferment of assessments

Approval of proposed changes in the Compensation Plan.

Approval of changes in the Classification Plan.

Approval of employment of any person in a position which requires the approval of Council except where State Statutes indicate otherwise.

Approval of increases in contracts for public works, either before or after contract is let except where an emergency has been declared.

Monitor and coordinate economic development.

Requests of employees or officers, either collectively or individually, for increase in either salary, wages or other benefit.

All budgets requiring action by Council.

Other matters that are referred by Council.

Requests for new or additional permanent positions in any City Department over which the Common Council has jurisdiction in this regard.

b. Committee on Public Works which shall be the Board of Public Works and the Board of Water Commissioners. The Board of Public Works shall also serve as the Stormwater Utility Committee. The Committee on Public Works shall be responsible for the management, control, improvement and regulation of all public grounds and grounds belonging to the City except such public grounds as under the laws of this State or the charter provisions or ordinances of the City are otherwise under the care and supervision of other officers, committees, boards or commissions.

c. Committee on Safety and Welfare which shall be concerned with traffic, police, fire, parks, health, building regulations, nuisances, and such other matters as the Council may refer to it.

d. Committee on Licenses/Permits which shall make recommendations to the Common Council with respect to the granting, denial, nonrenewal, suspension or revocation of any license or permit over which the Common Council has jurisdiction, and with respect to license or permit fees. It may also be the body before which license or permit nonrenewal, suspension or revocation hearings are held. Upon holding such hearing, it shall submit a report to the City Common Council, including findings of fact, conclusions of law and a recommendation as to what action, if any, the City Common Council should take with respect to the license or permit. The Committee on Licenses/Permits shall provide the complainant and the licensee with a copy of the report. Either the complainant or the licensee may file an objection to the City Common Council. The City Common Council shall determine whether the arguments shall be presented orally or in writing, or both. If the City Common Council, after considering the Committee on Licenses/Permits' report and any arguments presented by the complainant or the licensee, finds the Complaint to be true, or if there is no objection to a report recommending nonrenewal suspension or revocation, the license or permit shall not be renewed, suspended or revoked as provided by law. If the City Common Council finds the Complaint untrue, the proceedings shall be dismissed without cost to the accused. The City Clerk shall give notice of nonrenewal, suspension or revocation to the party whose license or permit is affected. Any Ordinances to the contrary shall be null and void.

e. Committee on Stormwater Utility which shall be empowered to govern, manage, control, improve and care for stormwater management services, systems, and shall have the powers and duties conferred upon it by the Code of General Ordinances of the City of Kenosha, and the Wisconsin State Statutes.

2. The Committees on Finance, Public Works, and Stormwater Utility shall consist of six (6) members of the Council and the Committees on Public Safety & Welfare and Licenses/Permits shall consist of five (5) members of the Council, all which members shall be appointed by the Mayor on or before the first Monday of May of each even numbered year. The Committees of Public Works and Stormwater Utility shall be made up of the same members.

The Chairman of each such Committee shall be elected annually on or before the third Monday in May of each year by majority vote of the members of each respective Committee. Votes cast for Chairman by members of each Committee may be by secret ballot. The Mayor shall, on the first Monday of May each year appoint one (1) member of each Committee as Acting Chairman until the respective Committee elects one. Every Alderman shall serve on a Committee and shall serve on the Committee to which he is appointed, unless excused by a majority of the members of the whole Council.

3. The Mayor, or the Common Council President, may declare the entire Council a Committee of the whole and may direct that it meet as such Committee of the whole during the course of a regularly scheduled Council meeting, provided that the Council Agenda is so noted, or at any other time. The calling of a special committee of the whole meeting, when not part of a regularly scheduled Council meeting, shall be through the same procedure as special meetings of the Common Council are called. The Mayor, and in his absence, the Council President, shall be Chairperson of such Committee of the whole.

4. The Mayor or Common Council may, from time to time, appoint such Special Committees as they deem necessary. Special Committees appointed by the Mayor must be confirmed by the Common Council prior to being effective. Special Committees shall not become operational until the Common Council adopts a Resolution creating or confirming them. The Resolution creating or confirming a Special Committee shall specify the purpose of the Committee, the length of time it shall operate, the number of the members thereof, the appointing authority of the members thereof, and the Committee Budget, if any.

All such Special Committees may conduct business only when a quorum is present, a quorum being a majority of the total number of members of said Committee. Each such Special Committee shall keep minutes of its proceedings and furnish a copy thereof to the Common Council as soon as practicable, but in no event longer than three (3) weeks after its meeting.

5. References to and Reports of Committees.

a. All Ordinances, Resolutions, communications and other matters submitted to the Council shall be read by naming the author and giving the title or substance thereof. Except for ordinances all other matters submitted to the Council shall be acted upon immediately by the Council, unless referred to an appropriate committee, commission, board or authority by the Mayor or by majority vote of the Council. Any alderperson may require the reading in full of any matter at any time it is before the Council.

b. Four members shall constitute a quorum of every Council Committee, except for the Public Safety & Welfare Committee and Committee on Licenses/Permits, which shall have a quorum of three. Each Committee shall at the next regular meeting, if possible, but not later than 45 days, submit a written report to the Council on all matters referred to it. Such report shall be signed by at least four members of the Committee, with the exception of the Public Safety & Welfare Committee and Committee on Licenses/Permits, which shall have its reports signed by at least three members of the Committee and shall indicate the division of the vote on the report. Any member or members may write his/her objection to the action taken by the majority of the Committee members reporting.

c. Previous notice of each Committee meeting shall be filed with the clerk by the chairmen, and each meeting shall be open to the public.

d. Any Committee may require any City officer to confer with it and supply information needed in connection with any matter pending before the Committee.

e. Fiscal Note. A standing Committee of Council upon a majority vote of the members present, or upon the written request of the Mayor to said Committee, shall request the Finance Director to furnish a fiscal note relative to the proposed action, and the matter shall be held in Committee, without action being taken thereon, until such fiscal note is filed with said Committee, notwithstanding any other provisions of the Ordinances or rules of parliamentary procedure.

f. Reports of Committees, where Common Council action is required for final approval, or where the matter was referred to a Committee by the Common Council, shall, upon receipt, be placed by the City Clerk on the next following agenda of the Common Council, subject to compliance with the Open Meeting Law. Notwithstanding the above, where multiple referrals for recommendation have been made by the Common Council, the City Clerk may hold the entire matter in abeyance until all recommendations have been received, or until forty-five (45) days from the date of referral have passed, whichever is first, and then place the report on the next following agenda of the Common Council.

Notwithstanding the above, the presiding officer of any body or subunit to which a matter has been submitted for review and recommendation, may withhold any item from being placed on the following Common Council Agenda for purposes of referring said matter back to his/her body or subunit for further consideration at its next regular or special meeting dealing with such matter.

Any sponsor may withdraw proposed legislation prior to the item being placed upon an agenda of the Common Council for final action. However, when such item has been referred to any body or subunit by the Common Council, the sponsor shall report such withdrawal, in writing, to the Common Council in a timely manner.

6. Agenda of Committee. The chairman or secretary of each Committee shall prepare a written agenda of matters to be considered at its next meeting in time so that every alderman will have a copy thereof at least 24 hours before such meeting. A copy of such agenda shall be mailed to each alderman at his residence. This requirement shall apply to Special Committees created under authority of §1.03 C.4., hereof.

Except for routine items, no matter shall be placed on a Committee Agenda unless it is first referred to the Committee by the Common Council or unless the Committee Chairperson or Acting Committee Chairperson assents to the inclusion of such item on the Committee's Agenda.

7. Public Hearings. Public Hearings shall be held by Committees of the Common Council for all items reviewed thereby which are not reviewed in an Executive Session.

E. Ordinances and Resolutions.

1. Any of the following may sponsor an Ordinance or Resolution:

- a. The Mayor.
- b. One (1) or more Alderperson(s).
- c. A Committee of the Common Council with respect to matters within its jurisdiction.
- d. The Board of Water Commissioners with respect to matters within its jurisdiction.
- e. The Board of Park Commissioners with respect to matters within its jurisdiction.
- f. The Museum Board with respect to matters within its jurisdiction.
- g. The Library Board with respect to matters within its jurisdiction.

2. Each ordinance and resolution shall have a Principal Sponsor, who is a person capable of sponsoring an ordinance or resolution and who directs and approves the language used in the ordinance or resolution proposed to the Common Council. In addition to a Principal Sponsor, each ordinance or resolution may have Co-sponsors or a Lead Co-sponsor, who was responsible for assisting in the drafting of the initial language; both who in conjunction with the Principal Sponsor, agrees to support the passage of the legislation. Additional co-sponsors should communicate as soon as practicable to the Principal Sponsor, City Attorney or City Clerk their desire to be added as a cosponsor. Only the Principal Sponsor may direct changes to the text of the proposed ordinance or resolution prior to adoption by the Common Council, which changes shall be communicated as soon as practicable by the City Attorney to the named Co-sponsors except the Common Council may, by majority vote, amend the proposed ordinance or resolution at the time it is considered for action in any manner except the addition or removal of Principal Sponsor, Lead Co-sponsor, or Co-sponsors unless said addition or removal is the Common Council. The Principal Sponsor, Lead Co-sponsor, and the Co-sponsors shall be separately designated on the ordinance proposal.

3. Before the adoption of any Ordinance the same shall be read at two separate meetings of the Council. Before the second reading the title of the Ordinance shall be published in full in the official

newspaper. On the second reading of the Ordinance a public hearing thereon shall be had. An aye and no vote of the Council shall be taken on an Ordinance only after such public hearing has been held.

4. No ordinance may be considered by the Common Council for final passage unless one of the following has occurred:

(a) if the ordinance was directly referred for comment through the Common Council agenda by either the Mayor pursuant to paragraph 1.03 A. 6. or by the Common Council pursuant to paragraph 1.03 A. 11., to one or more committees of the Common Council, to one or more commissions, boards, or authorities of the City, or to a combination thereof, either:

(i) if the ordinance was referred only to a committee or committees and not to any commission, board, or authority, all committees of the Common Council to which the ordinance was referred have reported on it or the time specified in subparagraph 1.03 D 5.f has elapsed; or

(ii) if the ordinance was referred to any single commission, board, or authority, or was referred to a combination of committees, commissions, boards, or authorities, all such bodies to which the ordinance was referred have reported on it or forty-five days have elapsed since the most-recent referral was made.

(b) if the ordinance was not directly referred for comment, a committee of the Common Council has nonetheless reported on it.

5. No ordinance or resolution that affects the rules or procedures of the Common Council, or that is directed specifically to alderpersons, including but not limited to rules respecting dress code at meetings, and respecting compensation or reimbursement of alderpersons, may be considered for adoption unless it has first been referred pursuant to provisions of subsection 1.03 A. to the following standing committees of the Common Council: the Committee on Finance, the Committee on Public Works, the Committee on Public Safety and Welfare, and the Committee on Licensing/Permits.

6. All proposed ordinances and resolutions must either be drafted by the City Attorney's Office or if not drafted by the City Attorney, forwarded to the City Clerk and the City Attorney within twenty-four (24) hours of referral from Common Council or placement onto an agenda to be approved by the City Attorney's Office as to format and reviewed for content and legality before they may be considered for adoption by the Common Council. The Principal Sponsor directs and has final approval for all proposed ordinance and resolution language.

F. Deliberations of Council. The deliberations of the Council shall be conducted in the following manner:

1. No alderman shall address the Council until he has been recognized by the presiding officer. He shall thereupon address himself to the chairman and confine his remarks to the question under discussion and avoid all personalities.

2. When two or more members simultaneously seek recognition the presiding officer shall name the member who is to speak first.

3. Only members of Council may address the Council, such address being limited to the matter on the floor or to the rules of parliamentary procedure as they may affect the matter on the floor except that:

a. The presiding officer on his own initiative or upon the request of a Council member, may permit any department head, officer, employee or representative of the City, the library, the museum, the water utility or of any board, commission, or advisory group to address the Council on the matter pending on the floor.

b. An Alderman, where a public hearing is not scheduled, may request a public hearing by unanimous consent, and said public hearing shall be held if no Alderman objects thereto. In the event of an objection, a public hearing may be authorized by a majority vote of the members present. All public comments shall be limited to the matter on the floor.

c. Citizens comments at all public hearings shall be limited to 5 minutes unless the Council suspends this rule by a majority vote of the members present, and permits either certain designated citizens or all citizens in general to speak on the issue pending on the floor. Any comment on other than a matter pending on the floor shall be out of order. Any public hearing may be terminated after 30 minutes by a majority vote of the members present except that a person or party who has a direct personal financial interest over and above the general interest of a taxpayer, in the pending Council action shall be permitted to speak after said hearing would have otherwise come to a close.

CODE OF GENERAL ORDINANCES, 2021 - KENOSHA, WISCONSIN

4. No motion shall be discussed or acted upon unless and until it has been seconded, unless the rules permit one alderman to initiate action. No motion shall be withdrawn without the consent of the person making the same and the person seconding it.

5. When a question is under discussion no action shall be in order, except (1) point of order, (2) to adjourn, (3) to recess, (4) to lay on the table, (5) to move the previous question, (6) to postpone to a certain day, (7) to refer to a Committee, (8) to amend, (9) to postpone indefinitely. These motions shall have precedence in the order listed.

6. Any member wishing to terminate the debate may move the previous question, in which event the Mayor shall announce the question as, "Shall the main question now be put?" If two-thirds (2/3) of the members present vote in the affirmative, the main question shall be taken without further debate, its effect being to put an end to all debate and to bring the Council to a direct vote, first upon any pending amendment, and then upon the main question.

7. Any alderperson may demand an aye and nay vote shall be recorded in the minutes. A roll call vote by roll call on any matter, and such roll call aye and nay vote is required on (a) passage of any Ordinance, (b) Resolutions, (c) confirmation of appointments (d) adoption of any measure assessing or levying taxes, appropriating or disbursing money; or creating any liability or charge against the City, or any fund thereof.

Every alderperson shall vote when a question is put unless there exists a conflict of interest and the alderperson announces his or her decision to abstain due to the conflict of interest. Any alderperson, failing to vote when a question is put, and continuing to fail to vote two minutes after a request for a vote from the Chair, shall be barred from further debating, commenting or voting on the question, and from debating, commenting or voting on any subsequent question or business remaining on the Agenda during the remainder of the Council meeting. This restriction shall not preclude any action or penalty otherwise prescribed or allowed under the Code of Ethics set forth in Chapter XXX of the City of Kenosha Code of General Ordinances.

An alderperson may not change his vote or any question after the result has been announced.

8. A motion to adjourn shall always be in order, and a motion to adjourn, to recess to lay on the table, and a call for the previous question shall be decided without debate.

9. **Reconsideration of Vote.** A motion to reconsider the vote on a confirmation of the appointment of a City official or on the award of any contract shall never be entertained and shall be out of order; and in other matters no motion for reconsideration shall be entertained or be in order unless (a) such motion be made and voted upon at the same or next regular meeting as when the vote to be reconsidered was originally had, and (b) no motion for reconsideration shall be entertained or be in order unless it is made by one of the aldermen whose vote prevailed when the motion involved was first subjected to a vote of the Council.

A motion to reconsider meeting the above requirements may be seconded by any alderman regardless of his previous vote on the matter.

A motion to reconsider being put and lost shall not be renewed or entertained.

10. Except for the maker of a motion no member shall speak a second time on a question until all who wish to speak have been heard.

11. Whenever in the opinion of the presiding officer a confusion exists because of the complexity of motions to amend, lay on the table, refer, or defer, he may with the consent of the maker of the original motion and the alderman who seconded it, expunge from the minutes all motions and votes taken on the subject and entertain any new motion germane to the subject matter.

12. When any matter is laid on the table, it shall not have the effect of prohibiting at succeeding meetings consideration and action taken on the same subject matter in the form of a new Resolution or Ordinance.

13. The presiding officer may at any time ask unanimous consent to suspend the rules, (except those imposed by statute) in any particular matter, and unless objection is made by any alderman, the rules may be suspended on his order.

14. A motion to reconsider shall not be necessary to repeal or amend an existing Ordinance or Resolution that is otherwise repealable or amendable.

15. On any business before the Council upon which a Committee has reported, a member representing the majority report shall have the privilege to make the first motion. Upon rejection of the majority report by action of the Council, the member representing the minority report shall have priority to make the next motion on the subject matter. Upon rejection of the minority report any other alderman may make any motion germane to the subject matter. This rule shall not deprive any alderman to debate each of the motions as made.

16. The approval of a Committee report in which the adoption of a Resolution or other matter is recommended shall comprise final action on such Resolution or other matter.

17. A majority vote of all members of Council in favor of any proposed Ordinance, Resolution or appointment shall be necessary for passage or approval, unless a larger number is required by statute. Except as otherwise provided, a majority vote of those present shall prevail in other cases.

18. If the presiding officer of the Common Council, a committee of the Common Council, or an authority, board, or commission of the City wishes to participate in the debate, the presiding officer must vacate the chair and pass the gavel to a member of the body who shall temporarily preside in the place of the presiding officer during the pendency of the time the presiding officer holds the floor. Provided that the presiding officer was not the maker of a motion on the matter while holding the floor, upon the presiding officer relinquishing the floor, he or she shall reassume the chair, retake the gavel and continue to preside. In the event that the presiding officer was the maker of a motion, he or she may reassume the chair on the ensuing matter. Nothing herein may be construed to prohibit the presiding officer from seconding motions without vacating the chair.

G. Minutes. Within not more than fifteen (15) days after each meeting of the Council, the Clerk shall supply to each alderman a printed copy of the proceedings thereof perforated for insertion in a ring binder.

H. Suspension of Rules. These rules or any part thereof may be temporarily suspended in connection with any matter under consideration by a recorded vote of two-thirds (2/3) of the members present.

1.035 SMOKING AT MEETINGS OF THE COMMON COUNCIL

There shall be no smoking at any duly convened meeting of the Common Council.

1.04 MAYOR

The Mayor shall be elected at the 2004 Spring election for a term of four (4) years, and every four (4) years thereafter. Effective on the third Tuesday in April, 2020, the Mayor shall receive a salary of \$7,257.00 per month. Effective on the third Tuesday in April, 2021, the Mayor shall receive a salary of \$7,366.00 per month. Effective on the third Tuesday in April, 2022, the Mayor shall receive a salary of \$7,477.00 per month. Effective on the third Tuesday in April, 2023, the Mayor shall receive a salary of \$7,589.00 per month. The salary shall be paid on the same schedule as provided for nonrepresented employees. The Mayor shall receive the same fringe benefits as Department Heads.

The Mayor shall devote his entire time to the duties of the office of Mayor. The Mayor shall have all the powers and duties given and imposed on the office by the statutes of the State of Wisconsin and shall have the general supervision of all City officers and heads of departments in the performance of their official duties.

The Mayor shall act as, and be charged with the duties of, Harbor Master, and as such he may make and publish rules and regulations governing the use of the harbor, which when approved by the Council shall have the same force and effect as Ordinances. The Mayor may appoint a Deputy Harbor Master who shall have the power, including that of arrest, necessary to enforce such rules and regulations, as has the Harbor Master.

1.045 WITHHOLDING OF THE ISSUANCE OF CITY LICENSES AND PERMITS BY THE CITY CLERK

A. Withholding of Issuance of Licenses/Permits. Licenses and Permits, whether initial, renewal, the subject of a conditional surrender coupled with a new application for a similar license(s), or a transfer, which are granted (approved) by the Common Council, or by the City Clerk/Treasurer, shall not be physically issued by the City Clerk/Treasurer to the applicant/licensee/permittee and the granted license/permit shall not be effective until the following conditions have been complied with by the applicant/licensee/permittee:

1. Outstanding personal property taxes which are delinquent and owing to the City of Kenosha have been paid to the City Clerk/Treasurer relative to personal property located within the City which:
 - a. was utilized by applicant/licensee/permittee in the business or activity for which a renewal license/permit is sought.
 - b. was utilized by applicant/licensee/permittee in any other business in which applicant/licensee/permittee was engaged as the sole operator or as a partner, where such status existed at the time of the granting of the license/permit.
 - c. was utilized by a former licensee/permittee from which a conditional surrender, coupled with a new application for a similar license(s), is sought.

2. Whenever there is a conditional surrender, coupled with a new application for a similar license(s), of a license relative to any premise which is the subject of a license/permit:
 - a. current and determined personal property taxes of the former licensee/permittee must be paid to the City Clerk/Treasurer.
 - b. if the current personal property taxes have not yet been determined, an escrow of estimated personal property taxes of the former operator must be paid to the City Clerk/Treasurer, which shall be calculated by multiplying the current year's mill rate times the assessed value of the personal property as of January 1 of the year of the conditional surrender coupled with a new application for a similar license(s) or change in licensee/permittee.

3. In the case of "Class A", Class "A", "Class B", Class "B" Licenses, or any combination thereof, or any "Class C" License, outstanding liquor, fermented malt beverage and wine bills which are owed to a wholesaler in violation of the credit restrictions in State law imposed upon retail seller, have been paid to the wholesaler.

4. All unfulfilled requirements and violations of the City Building, Fire, Health Codes and Zoning Ordinance which have been brought to the attention of the Common Council, or any Committee thereof, in writing, by appropriate City departments at the time of the granting of said license have been complied with and compliance has been noted in writing and filed with the City Clerk/Treasurer, by the appropriate departments.

5. Applicable license/permit fees and the related costs of the issuance of licenses/permits, if any, have been paid to the City Clerk/Treasurer.

6. Any past due forfeitures imposed by the Kenosha Municipal Court upon any corporate officer or agent if the applicant/licensee/permittee is a corporation, any partner if the applicant/licensee/permittee is a partnership, or any individual if the applicant/licensee/permittee is an individual have been paid to the City Clerk/Treasurer's Office.

7. A "Class A", Class "A", "Class B", Class "B", or any combination thereof, or any "Class C" License applicant/licensee/permittee has provided proof of ownership of the premise proposed to be covered by the license. In the absence of ownership, the applicant/licensee/permittee must provide proof of an executed lease for the premise proposed to be covered by the license/permit.

B. Definitions. The term "paid", as used herein, means full payment in lawful United States currency or full payment through checks or drafts supported by sufficient United States currency on deposit to honor said obligation.

C. Exceptions. The above requirements shall not be enforced where:

1. Defense. By sworn Affidavit, the applicant/licensee/permittee states:

a. They have a good faith defense to the above requirements and state the defense in detail, relative to both facts and legal theories, and furnish supporting documentation.

b. They have taken or are taking prompt action to challenge the above requirements in an appropriate forum.

The City Clerk/Treasurer may reject said Affidavit, upon the advice of the City Attorney, if it is insufficient or frivolous. Further hearing and appeal from such decision shall be in accordance with Chapter 68, Wisconsin Statutes, Municipal Administrative Procedure.

The filing of a false or frivolous Affidavit shall be grounds for license/permit suspension or revocation.

2. Stipulated Agreement of Compliance. When the applicant/licensee/permittee by written stipulation affirms the outstanding conditions and/or liabilities for which issuance of the license/permit is withheld and stipulates to a schedule for compliance and/or payment of the outstanding conditions and/or liabilities, the license/permit may be issued by the clerk. Failure to comply with the terms of said agreement shall be a basis for immediate revocation of the license/permit.

1.046 CITY MANAGEMENT

A. Progression Of Authority. In a declared "State of Emergency", covered under §1.14 of the Code of General Ordinances, in which the Mayor is unable to serve, the charge of the day to day administration of the City shall succeed in the order given as follows: City Administrator(s), then Director of Public Works. None of the successors herein specified shall have the right to exercise any mayoral powers which would otherwise succeed, as a matter of law, to the President of the Common Council.

B. City Administrator.

1. Duties. One or more City Administrators shall be officers of the City and shall, under the direction of the Mayor and Common Council, be charged with the administration and control of the operation of the City and the coordination of its Departments and subunits, all to be performed in accordance with applicable laws, rules, regulations and master plans.

2. Appointment. Each position of City Administrator shall be filled in either of the following ways:
a. appointment by the Mayor, subject to approval by the Common Council, from an eligible list supplied according to the Ordinances and Rules of Civil Service; or
b. appointment by the Mayor, subject to a contract approved by the Common Council.

3. Application of Civil Service Rules. A City Administrator appointed pursuant to paragraph 2.a. holds the position subject to the Civil Service rules. A City Administrator appointed pursuant to paragraph 2.b., holds the position pursuant to the contract terms, and is not subject to Civil Service rules.

1.05 CITY DEPARTMENTS

A. Police Department.

1. The Police Department shall consist of a Chief appointed by the Board of Police and Fire Commissioners and such subordinate officers and positions as now are or may be created by the Council

and such number of ordinary members as the Council now deems or may deem necessary for the proper and efficient operations of said Department.

2. Appointment of Subordinates. (See §62.13 of Wisconsin Statutes.)

3. Additional Help. The Mayor may employ additional help for temporary and special emergency cases.

4. Regulations. Members of the department shall be governed by the rules and regulations adopted by the Council.

5. a. Intent. It is the intent of this section that the Police Chief annually presents to the Common Council an updated Strategic Plan in which the department communicates its mission, vision for the future, well-defined goals, and performance objectives to accomplish these goals. The Strategic Plan is intended to be a five-year, flexible roadmap that guides the department and City toward the future in the continuing commitment to deliver superior performance with effective allocation of resources. Annual reviews prior to the presentation will ensure that the goals and performance objectives are kept current and aligned to the changing needs and expectations of the community.

b. Strategic Plan Content

The initial Strategic Plan for the department, and every update presented thereafter, shall contain:

- The department's mission;
- The department's vision for the future;
- Well-defined goals to be accomplished by the department over the ensuing five years;
- Performance objectives to accomplish the goals of the department;
- Staffing levels to accommodate the growth of the City and the management of the department, with any necessary phase-in milestones;
- An equipment purchase/replacement portion of the report to coincide with the five-year Capital Improvement Plan required in Subsection 2.02 D.;
- A real property portion of the report to address necessary improvement to existing stations or satellite offices, to coincide with the five-year Capital Improvement Plan required in Subsection 2.02 D; and
- Options for siting a new station or satellite stations deemed necessary for the public safety of the citizens of the City.

c. Annual Report by the Police Department. At the first regularly scheduled meeting of the Common Council in October of each year, the Police Chief, or his or her designee, shall prepare and present a written Strategic Plan for the department to the Common Council detailing a plan for the ensuing five years.

B. Fire Department.

1. The Fire Department shall consist of a chief appointed by the Board of Police and Fire Commissioners and such subordinate officers and positions as now are or may be created by the Council and such number of ordinary members as the Council now deems or may deem necessary for the proper and efficient operation of said Department.

2. Appointment of Subordinates. (See §62.13, Wisconsin Statutes.)

3. Additional Help. The Mayor may employ additional help for temporary and special emergency cases.

4. Regulations. Members of the department shall be governed by the rules and regulations adopted by the Council.

5. a. Intent. It is the intent of this section that the Fire Chief annually presents to the Common Council an updated Strategic Plan in which the department communicates its mission, vision for the future, well-defined goals, and performance objectives to accomplish these goals. The Strategic Plan is intended to be a five-year, flexible roadmap that guides the department and City toward the future in the continuing

commitment to deliver superior performance with effective allocation of resources. Annual reviews prior to the presentation will ensure that the goals and performance objectives are kept current and aligned to the changing needs and expectations of the community.

b. Strategic Plan Content

The initial Strategic Plan for the department, and every update presented thereafter, shall contain:

- The department's mission;
- The department's vision for the future;
- Well-defined goals to be accomplished by the department over the ensuing five years;
- Performance objectives to accomplish the goals of the department;
- Staffing levels to accommodate the growth of the City and the management of the department, with any necessary phase-in milestones;
- An equipment purchase/replacement portion of the report to coincide with the five-year Capital Improvement Plan required in Subsection 2.02 D.;
- A real property portion of the report to address necessary improvement to existing stations or satellite offices, to coincide with the five-year Capital Improvement Plan required in Subsection 2.02 D; and
- Options for siting a new station or satellite stations deemed necessary for the public safety of the citizens of the City.

c. Annual Report by the Fire Department. At the first regularly scheduled meeting of the Common Council in October of each year, the Fire Chief, or his or her designee, shall prepare and present a written Strategic Plan for the department to the Common Council detailing a plan for the ensuing five years.

C. City Clerk/Treasurer.

1. The City Clerk/Treasurer is charged with the duties devolving upon the City Clerk and the City Treasurer as provided by Wisconsin law.

2. The administrative head of this department shall be known as the City Clerk/ Treasurer who shall hold his office under Civil Service. Any vacancy occurring in said office shall be filled by appointment by the Mayor subject to the approval of the Common Council from an eligible list supplied according to the Ordinances and Rules of Civil Service.

D. Department of Finance.

1. The Department of Finance is charged with the duties devolved upon the Director of Finance as provided by Wisconsin law.

2. The administrative head of this department shall be known as the Director of Finance and Finance Coordinator who shall hold his/her office under Civil Service and any vacancy occurring in said office shall be filled by appointment by the Mayor, subject to approval of the Common Council from an eligible list supplied according to the Ordinances and Rules of Civil Service.

3. The Finance Department is charged with the duty of administering the Purchasing Operations of the City through a subunit to be known as "THE PURCHASING DIVISION".

E. Department of Public Works.

1. The Department of Public Works shall be under the general supervision of the Mayor and, with respect to Public Works, the Board of Public Works (Public Works Committee), and with respect to Parks, the Board of Park Commissioners. The Department shall be charged with:

a. The construction, reconstruction, cleaning, repair and maintenance of all streets, storm sewers, bridges and other infrastructure.

b. The management and operation of the Municipal Service Garage, and Central Stores.

c. The performance of the engineering services necessary for the planning, design, construction, and reconstruction of streets, sidewalks, storm sewers, and other public improvements and facilities.

d. Waste collection, removal and disposal and bulky solid and recyclable material waste collection and disposal.

e. Traffic engineering.

f. The development, maintenance and operation of all City parks, the Municipal Golf Course, City Forestry, swimming pools and special events on park land.

g. Snow plowing and salting of streets.

h. Such other duties as imposed by Statute, Ordinance or Resolution.

2. The administrative head of this department shall be known as the Director of Public Works, who shall hold his/her office under Civil Service. Any vacancy occurring shall be filled through appointment by the Mayor subject to approval by the Common Council from an eligible list supplied according to the Ordinances and Rules of Civil Service.

The Mayor shall appoint an employee of the Department who is a Professional Engineer in the State of Wisconsin, in good professional standing, to serve as City Engineer and notify the Common Council of the Appointment.

3. City Traffic Engineer. The Traffic Engineer shall be under the general supervision of the Director of Engineering Services and shall plan and review traffic safety and operations on City streets and alleys; review and recommend the geometric design or redesign and lighting of all streets, alleys, and parking facilities with respect to traffic needs; make recommendations to the Mayor and Common Council on the establishment of Ordinances, Resolutions, policies, practices, and standards which would promote traffic safety, the efficient use of energy, or improved traffic operations; conduct engineering investigations and analyses of traffic accidents and other traffic conditions, coordinate, with the Police Department, studies to determine the reasons for traffic accidents and violations, and devise remedial measures.

a. The Traffic Engineer shall install and maintain street lighting and official traffic control devices, within the meaning of §340.01(38), Wisconsin Statutes, necessary to make effective the provisions of Wisconsin Statutes and specific Ordinances, Resolutions, policies, or standards adopted by the Common Council, and may also place and maintain additional traffic control devices, not inconsistent with City Ordinances or Wisconsin Statutes, that he/she deems necessary to regulate, warn, or guide traffic. The design, installation, and operation or use of all traffic control devices placed and maintained in the public right-of-way, whether permanent or in temporary use, such as in construction, maintenance, or utility work areas, shall conform to the applicable provisions of the Wisconsin Manual on Uniform Traffic Control Devices, as required by §349.065, Wisconsin Statutes; the Traffic Engineer may either make, or if appropriate require that the person(s) responsible for any construction, maintenance, or utility work make changes in the selection or use of traffic control devices that he deems necessary for conformance to the MUTCD, the safety of persons working in the roadway, or the safe movement of traffic. The Traffic Engineer may remove, or order the removal of, any unauthorized sign or other device placed in violation of §346.41, Wisconsin Statutes.

b. The Traffic Engineer, acting pursuant to the findings of an engineering investigation and analysis, may establish and designate by official traffic control device(s), and thereafter maintain, the following:

(1) Traffic lanes.

(2) Crosswalks.

(3) Lane-use control.

(4) Safety zones.

(5) Bus stops, after consultation with the Director of Transportation.

(6) "No Parking" zones not to exceed one hundred (100) feet in length.

c. The Traffic Engineer or Public Safety and Welfare Committee of the Council may establish and designate temporary traffic or parking regulations for emergency situations, construction and maintenance work zones, and other special conditions. The Traffic Engineer may establish and designate temporary or experimental traffic or parking regulations, or designate temporary or experimental traffic control devices, for a period up to ninety (90) days, except that such regulations or experiments may be continued for an additional ninety (90) days unless the Common Council directs otherwise.

4. Parks Division.

a. The Parks Division shall be under the general supervision of the Department of Public Works and the Board of Park Commissioners, and shall be charged with the development, maintenance and operation of all City parks, the Municipal Golf Course, swimming pools, special events on park land, the Marinas, and such other duties as imposed by Statute, Ordinance or Resolution.

b. The administrative head of the Parks Division shall be the Superintendent of Parks, who shall be under the general supervision of the Director of Public Works.

I. Department of Law.

1. The City Attorney, through the express and implied powers of a City Attorney, shall conduct all the law business in which the City is interested, to the extent and through the means he deems necessary and appropriate, including, but not specifically limited to, the following:

a. He shall give written legal opinions when requested by City officers.

b. He shall draft Ordinances, bonds and such other instruments as may be required by City officers.

c. He shall examine the tax and assessment rolls and other tax proceedings, and advise the proper City officers in regard thereto.

d. He may appoint one or more attorneys to assist him, who shall have power to perform the duties of the City Attorney and for whose acts the City Attorney shall be responsible to the City. Said assistants shall perform such tasks as may be assigned under the guidance, direction and supervision of the City Attorney. Such assistant shall receive no compensation from the City unless specifically authorized in advance by the Common Council.

e. He shall prosecute such violations of the City Ordinances as are brought to his attention which he believes to merit prosecution and he shall have authority to dismiss with or without prejudice any Ordinance prosecution which has been commenced which he does not believe to merit continued prosecution.

f. He shall collect all monies which he has reason to believe are lawfully owing to the City in contract or tort when such outstanding debts or obligations are brought to his attention by appropriate City officers.

g. He shall collect all taxes, assessments and special assessments which he has reason to believe are lawfully owing to the City when such debts and obligations are brought to his attention by appropriate City officers.

h. He may seek such injunctive and equitable relief which he has reason to believe is necessary to protect the best interest of the City and shall enforce such City and State laws, rules and regulations which the City is empowered or obligated to enforce.

i. He shall defend the City in all litigation against the City seeking legal damages or equitable relief.

j. He shall perform such duties as are required by contractual arrangements with other units of government.

k. He shall defend City officers or employees or members of any board or commission thereof in actions brought against them individually or jointly, in actions in law or equity, for any acts done in the course of their employment or out of any alleged breach of duty excepting actions brought to determine the right of such officer or employee or member to hold or retain their office or position, excepting actions against candidates for elected offices alleging a breach of election or campaign laws, and excepting actions brought by the City against any officer or employee thereof.

l. He may commence an action in law or equity or other legal process against a City employee, officer, or board or commission member only where the City Attorney is so authorized by Ordinance or Resolution where the cause of action or complaint is alleged to have arisen out of the performance of the job or duties or neglect thereof of said employee officer or board or commission member. This Section shall not prohibit the City Attorney from prosecuting, upon request of an appropriate City officer, without Council approval, any such individual for any Ordinance violation, or from prosecuting any employee charged with a violation of the Civil Service Ordinance or Rules and Regulations promulgated thereunder.

m. He may commence litigation against a labor union or the officers or members thereof in any labor matter only where so directed by Resolution of the Common Council. He shall handle grievances upon request by appropriate City officers without the consent of Council.

n. He shall represent the City in all hearing and pre- or post hearing proceedings before any City, State or Federal boards, commissions committees or administrative agencies, whether legislative, judicial or quasi-judicial in nature, where requested by an appropriate City officer.

o. He shall be authorized in the name of the City to settle or compromise any money claim the City may have or allege to have against any person party, partnership, trust, corporation or other legal entity where the total value claimed is not in excess of Five Hundred (\$500.00) Dollars. Claims, settlements and

compromises over Five Hundred (\$500.00) Dollars must be approved by the Finance Committee and the Common Council. The City Attorney shall file one or more reports per annum with the Common Council listing and identifying all such settlements and compromises and listing the reasons therefor. The City Attorney must seek the approval of the Finance Committee and Common Council to settle or compromise any suits or claims in any amount filed against the City. The City Attorney shall have authority to settle or compromise any Worker's Compensation claim in any amount. The City Attorney shall, in his discretion, have authority to retain outside counsel to collect Worker's Compensation claims and to authorize reasonable payment for the collection thereof.

p. He shall obey all lawful orders and directives of the Common Council.

q. He may authorize an attorney or law firm representing an insurance company insuring the City to bring suit against a tortfeasor in the name of the City to recover any deductible paid by the City and to pay attorney's fees on a contingent fee basis.

r. He shall, in writing, advise the Director of Finance as to which accounts receivable are in law or practice uncollectible and the Director of Finance shall, upon receiving such report, be authorized to remove such accounts receivable from the books of account, in accordance with generally accepted accounting practices.

2. The head of this Department shall be the City Attorney who shall hold his office under Civil Service. Any vacancy in his office occurring on or after April 15, 1958 shall be filled by appointment by the Mayor subject to the approval by the Common Council from an eligible list supplied according to the Ordinances and Rules of Civil Service.

K. Department of City Development.

1. The Department of City Development is under the general supervision of the Mayor and City Administrator. The Department of City Development is charged with the duties of administering various programs and activities including, but not limited to, planning, zoning, the Community Development Block Grant program, the Home Investment Partnership Act (HOME) program, redevelopment, historic preservation programs, and Sign Code enforcement.

2. The Administrative Head of the Department of City Development is the Director of the Department of City Development, who holds his/her office under Civil Service. Any vacancy occurring in said office will be filled through appointment by the Mayor, subject to confirmation by the Common Council from an eligibility list supplied by the Human Resources Department in accordance with the Civil Service System Ordinance and Personnel Rules and Regulations. The Director of City Development serves as Secretary of the City Plan Commission, Redevelopment Authority of the City of Kenosha, and the Board of Zoning Appeals.

L. Airport Department.

1. The Airport Department shall be administered by the Airport Director under the general supervision of the Airport Commission and charged with the management of the Kenosha Regional Airport. The Airport Director shall act as Secretary to the Airport Commission.

2. The Administrative Head of the Airport Department shall be the Airport Director, who shall hold his/her office under Civil Service, and any vacancy in his/her office shall be filled by appointment by the Mayor, subject to confirmation by the Airport Commission and the Common Council, from an eligible list supplied according to the Ordinance and Rules of Civil Service.

M. Human Resources Department.

1. The Human Resources Department shall be under the general supervision of the Mayor and City Administrator, and shall be charged with the administration of the Personnel policies and practices of the City, the Civil Service System, collective bargaining, health insurance, risk management, and Federal and State laws, rules and regulations affecting the employer-employee relationship.

2. The administrative head of the Human Resources Department shall be the Director of Personnel, who shall hold his/her office under Civil Service. The Director of Personnel shall also perform the duties of

the Supervisor of Personnel under the City's Civil Service Ordinance. Any vacancy occurring in said office shall be filled through appointment by the Mayor, subject to the approval of the Common Council, from an eligible list supplied by the Human Resources Department in accordance with the Ordinances and rules governing Civil Service.

O. Department of Transportation.

1. The Department of Transportation is charged with the operation of the City Transit System and Public Parking Facilities.

2. The administrative head of this department shall be known as the Director of Transportation who shall hold his/her office under Civil Service. Any vacancy shall be filled by appointment by the Mayor, subject to approval by the Common Council, from an eligible list supplied according to the Ordinances and Rules of Civil Service.

P. Assessment Department.

1. The Assessment Department shall be under the general supervision of the Mayor and City Administrator, and shall be charged with the development, implementation and administration of the assessing of all real and personal property located in the City under authority of Chapter 70, Wisconsin Statutes,

2. The administrative head of the Assessment Department shall be the City Assessor, who shall hold his/her office under Civil Service. Any vacancy occurring in said office shall be filled through appointment by the Mayor, subject to the approval of the Common Council, from an eligible list supplied by the Personnel Division in accordance with the Ordinances and rules governing Civil Service.

Q. Department of City Inspections.

1. The Department of City Inspections is under the general supervision of the Mayor and City Administrator. The Department of City Inspections is charged with the duties of administering various programs and activities including, but not limited to, enforcement of the Building Code, of property maintenance building inspections, and of the Minimum Housing Code.

2. The Administrative Head of the Department of City Inspections is the Director of the Department of City Inspections. The Director of City Inspections or his/her designee, serves as Secretary of the Board of Housing Appeals of the City of Kenosha.

3. Any vacancy occurring in the position of Director of City Inspections is filled through appointment by the Mayor, subject to confirmation by the Common Council in either of the following ways:

a. appointment by the Mayor, subject to approval by the Common Council, from an eligible list supplied according to the Ordinances and Rules of Civil Service; or

b. appointment by the Mayor, subject to a contract with the nominee for the Director position, which contract and appointment are approved by the Common Council.

4. A Director of City Inspections appointed pursuant to paragraph 3.a. holds the position subject to the Civil Service rules. A Director of City Inspections appointed pursuant to paragraph 3.b., holds the position pursuant to the contract terms, and is not subject to Civil Service rules.

R. Aldermanic Notice.

Whenever a City department, or personnel authorized by the department, has scheduled a public meeting, separate aldermanic written notice shall be given by the department to each alderperson at least 72 hours prior to the commencement of such meeting unless for good cause such notice is impossible or impractical, in which case shorter notice may be given, but in no case may the notice be provided less than two (2) hours in advance of the meeting. The written notice shall be on paper and in electronic mail (e-mail) format. The affected alderperson(s) shall be required to give approval for their district. Receipt shall be presumed upon delivery to the aldermanic mailbox located within City Hall and upon sending an electronic message to the alderperson's City issued e-mail account. The notice shall announce the time,

CODE OF GENERAL ORDINANCES, 2021 - KENOSHA, WISCONSIN

place and subject matter of the meeting. "Public Meeting" means the convening of employees of a City department for the purpose of meeting with the public to discuss a topic which is subject to the responsibility, authority, or duties delegated to the department.

1.055 DEPARTMENT OF MUNICIPAL COURT

1. Pursuant to §755.01, Wisconsin Statutes, there is hereby created the office of Municipal Judge for the City of Kenosha. "The Municipal Judge shall be head of a Department known as the Department of Municipal Court."

2. **Term.** The term of Municipal Judge shall be four years commencing on the 1st day of May, 1980.

3. **Compensation.** The salary for the office of Municipal Judge in lieu of fees or costs shall be \$67,859.00 per annum commencing on the third Tuesday in April, 2020. Effective on the third Tuesday in April, 2021, the Municipal Judge shall receive a salary of \$69,216.00 per annum. Effective on the third Tuesday in 2022, the Municipal Judge shall receive a salary of \$70,600.00 per annum. Effective on the third Tuesday in April, 2023, the Municipal Judge shall receive a salary of \$72,012.00 per annum. No compensation shall be paid to the Judge for any time during his term for which he or she has not executed and filed his or her official bond and oath as required by Subsection 4. No compensation shall be paid for any day for which Court is scheduled to be in session pursuant to 7.a. of this Ordinance for which the City Municipal Judge is not in attendance except that said Municipal Judge shall be permitted two and one-half (2-1/2) working days off per full calendar month worked which time may be used as sick time vacation time or personal time. Where possible two (2) weeks advance notice of an off day or off days shall be submitted in writing to the City Administrator, the City Attorney and the City Police Chief. The Municipal Judge shall, as a condition precedent to receiving any compensation in the forthcoming month file an Affidavit with the City Treasurer on or before the last working day of each calendar month stating that "No case which has been submitted in final form to him in the past thirty (30) days, exclusive of time of total disability, if any, remains undecided."

4. **Bond: Oath.** The Municipal Judge shall execute and file with the Clerk of the Circuit Court for Kenosha County the oath prescribed by law (§757.02, Wisconsin Statutes) and a bond in the penal sum of \$2,000 as prescribed by §62.09(4), Wisconsin Statutes.

5. **Qualifications.** The Municipal Judge shall be licensed to practice law in the State of Wisconsin.

6. Jurisdiction.

a. The Municipal Judge shall have such jurisdiction as provided in §§755.045 and 755.05, Wisconsin Statutes, and exclusive jurisdiction of violations of City Ordinances.

b. The Municipal Judge shall have contempt of court authority in the Municipal Court for the City of Kenosha as provided by Wisconsin Statutes §800.12. Contempt of Court procedure shall be governed by Wisconsin Statute §800.12.

7. Procedure.

a. The Court of the Municipal Judge shall be called the "Municipal Court for Kenosha, Wisconsin" and shall be open daily, except Saturdays, Sundays and legal holidays, from the hour of 8:00 A.M. until such time as the daily agenda shall be disposed of, but not later than 4:30 P.M., unless so directed by the Municipal Judge. The Municipal Court shall, in addition to the above, be open one day per calendar month on the last Tuesday of the month from 5:00 P.M. until the evening agenda is disposed of, but not later than 9:30 P.M., unless so directed by the Municipal Judge. The evening session shall only be held for the benefit of citizens who have requested the Municipal Court to so schedule their case and will not be held if no such requests have been made.

b. The procedures of the Municipal Court shall be in accordance with Chapter 800, Wisconsin Statutes, Chapter 48, Wisconsin Statutes, and with any other applicable Wisconsin Statutes and City Ordinances. The Municipal Court shall also be bound by the Rules of Evidence specified in Chapters 901 through 911, Wisconsin Statutes. In nontraffic matters, the City Attorney's Office shall draft a bond deposit schedule, which shall be submitted to the Municipal Judge. Pursuant to Section 800.037, Wisconsin Statutes, the Municipal Court, with the approval of the Common Council, shall set the deposit schedule for all cases other than traffic cases and boating cases. The deposit in traffic cases shall be made as provided in Section 345.26, Wisconsin Statutes. The amount of the bond deposit shall not exceed the maximum penalty established by the municipality for the offense, plus costs, fees and surcharges imposed under

CODE OF GENERAL ORDINANCES, 2021 - KENOSHA, WISCONSIN

Chapter 814, Wisconsin Statutes. After approval of the bond deposit amounts by the Common Council, the Chief of Police shall be furnished a copy of all nontraffic bond schedules and amendments thereto.

In traffic regulations cases, the basic amount of bond deposit shall be determined in accordance with a deposit schedule which the Judicial Conference shall establish.

c. The Municipal Judge shall cause to be collected all fines and forfeitures and taxable costs in any action or proceedings before him. The City Treasurer shall direct the manner and place(s) in which such monies shall be collected. Such monies shall be paid over to the City Treasurer at such times and in such a manner as the City Treasurer shall direct. The Municipal Judge is responsible for the accounting distribution of all monies collected on behalf of the Municipal Court for which an official Municipal Bond Receipt has been presented as evidence of collection. The Municipal Judge shall provide a daily report which shall be submitted to the City Treasurer setting forth full accountability of the aforementioned collections.

8. Bailiff. A full-time police officer selected by the Chief of Police shall be assigned to the Municipal Court.

9. Employees. The Court shall be staffed by such clerical personnel as are authorized by the Common Council. Such employees will be selected through the Civil Service process as are other City employees holding similar positions. Staff work priorities and standards will be developed cooperatively between the Municipal Judge and the Comptroller to ensure that all legal and statutory deadlines and obligations will be achieved. The Municipal Judge shall have the final authority and determination of work priorities and standards to be implemented by the Comptroller. The Comptroller shall be the appointing authority of and shall have jurisdiction over such position(s). Such employees are subject to the direction of the Comptroller only. Court personnel shall be covered by a blanket bond paid for by the City.

10. Substitute and Interim Municipal Judge. In the event that a Municipal Judge is to be temporarily absent or is sick or disabled, the provisions of §800.06, Wisconsin Statutes, shall apply. A permanent vacancy in the office of Municipal Judge shall be filled according to the provisions of §8.50 (4)(fm), Wisconsin Statutes. Substitute and Interim Municipal Judges shall receive a fee of \$200.00 per Court session.

11. Case Schedule. Where possible, the following time frames will be used in the Municipal Court:

a. Law enforcement officers and others chargeable with the responsibility of writing citations or other legal process which provides a Court date, shall, at the time of issuance of said citation, provide a Court date which is within thirty (30) days of the date of issuance. The party charged with an Ordinance violation shall not have the right to be heard in night court if any available night court date is not available within thirty (30) days of the date charged. The failure of an issuing officer or official to provide the opportunity for a night court hearing or a hearing within thirty (30) days of the date of issuance shall not, in any manner, constitute a defense to the violation charged.

b. The Court, where an adjournment is requested and in the discretion of the Court granted, shall provide an adjourned date within thirty (30) days of the date of the request for an adjournment.

c. The Municipal Judge shall, where a case has been submitted to him in final form, issue a determination of guilt or innocence within thirty (30) days thereafter.

12. Fees, Costs and Surcharges in Municipal Court. Pursuant to §§800.10 and 814.81, Wisconsin Statutes, all forfeitures, fees, surcharges, and costs imposed by the Municipal Court Judge will be paid to the City of Kenosha as follows:

a. Whenever the Municipal Court Judge imposes a forfeiture for a violation of a City of Kenosha Ordinance, except for Ordinances adopting non-moving traffic violations as defined herein, safety belt use violations under §347.48(2m), Wisconsin Statutes, financial responsibility violation under §344.62(2) Wisconsin Statutes, violations under §343.51(1m)(b), Wisconsin Statutes or clean indoor air violations under Section 101.123(2)(a) or (5), Wisconsin Statutes, there shall be imposed, in addition to the forfeiture, the following:

(1) A penalty surcharge as specified in §757.05, Wisconsin Statutes 2012-2013 and any amendments thereto. If multiple offenses are involved, the penalty surcharge shall be based upon the total forfeiture for all offenses. When a forfeiture is suspended in whole or in part, the penalty surcharge shall be reduced in proportion to the suspension. The penalty surcharge shall be collected by the City Treasurer and

CODE OF GENERAL ORDINANCES, 2021 - KENOSHA, WISCONSIN

transmitted by the City to the Secretary of Administration as provided in §66.0114(1)(bm), Wisconsin Statutes.

(2) The Municipal Judge shall collect a fee of Thirty-eight (\$38.00) Dollars on each separate matter, whether it is on default of appearance, a plea of guilty or no contest, on issuance of a warrant or summons or the action is tried as a contested matter. Excepted from this subsection are violations of §343.51(1m)(b), §344.62(2) financial responsibility violations under §344.62(2) Wisconsin Statute, or §347.28(2m), Wisconsin Statutes, for which no fee shall be collected. Of each fee received by the Judge under this subsection, the City Treasurer shall pay monthly the amount specified in Section 814.65(1), Wisconsin Statutes, to the Secretary of Administration for deposit in the general fund of the State and shall retain the balance for the use of the City.

(3) A jail surcharge as specified in §302.46(1), Wisconsin Statutes 2012-2013, and any amendment thereto. If multiple offenses are involved, the Court shall determine the jail surcharge on the basis of each forfeiture. If a forfeiture is suspended in whole or in part, the Court shall reduce the jail surcharge in proportion to the suspension. The jail surcharge shall be collected by the City Treasurer and transmitted by the City to the County Treasurer under §800.10(2), Wisconsin Statutes.

(4) Any applicable domestic abuse surcharge imposed as specified in §973.055, Wisconsin Statutes, and any amendments thereto. Domestic Abuse surcharges shall be collected by the City Treasurer and transmitted by the City to the State Treasurer as provided in §66.0114(1)(bm), Wisconsin Statutes.

(5) Any applicable driver improvement surcharge imposed as specified in §346.655, Wisconsin Statutes, and any amendments thereto. The driver improvement surcharge shall be collected by the City Treasurer and transmitted by the City as provided in Section 346.655(2)(b), Wisconsin Statutes, 2012-2013 and any amendment thereto.

(6) A crime laboratories and drug law enforcement surcharge imposed as specified in §165.755, Wisconsin Statutes, and any amendments thereto. Excepted from this subsection are violations of §101.123(2) or (2m), Wisconsin Statutes, a financial responsibility violation under §344.62(2), Wisconsin Statutes, a non-moving traffic violation, a violation under §343.51(1m)(b), Wisconsin Statutes, or safety belt violations under §347.48(2m), Wisconsin Statutes. The crime lab surcharge shall be collected by the City Treasurer and transmitted to the Secretary of Administration as provided in §66.0114(1)(bm), Wisconsin Statutes.

(7) Any applicable ignition interlock surcharge as specified in §343.301(5), Wisconsin Statutes, and any amendment thereto. The ignition interlock surcharge shall be collected by the City Treasurer and transmitted by the City to the County Treasurer.

b. In addition to the forfeiture and mandatory costs and surcharges, the Municipal Court Judge may impose the following:

(1) Any applicable witness and interpreter fees as specified in §814.67, Wisconsin Statutes, 1991-1992, and any amendments thereto.

(2) Any costs and fees allowed pursuant to §814.65(4), Wisconsin Statutes 1991-1992, and any amendments thereto.

(3) Any costs on motion allowed pursuant to §345.37(1)(b), Wisconsin Statutes 1991-92, and any amendments thereto.

(4) Any costs and fees allowed pursuant to §814.65(4m), Wisconsin Statutes, 2012-2013, and any amendments thereto.

c. Persons required to make bail deposits for violations of City of Kenosha Ordinances shall also deposit an amount sufficient to include the penalty surcharge, jail surcharge, crime laboratory and drug law enforcement surcharge, court costs and any applicable domestic abuse surcharge, driver improvement surcharge, or ignition interlock surcharge. If the bail is forfeited, the City shall transmit the penalty surcharge, court costs and any applicable driver improvement surcharge, or domestic abuse surcharge to the State Treasurer or Secretary of Administration, and the jail surcharge to the County Treasurer as herein provided in Subsection 12a. of this Ordinance.

d. Nonmoving traffic violations are defined as violations of Ordinances adopted under §349.13- 14, Wisconsin Statutes, and violations of §346.50 - 346.55, Wisconsin Statutes.

(8) Any applicable safe ride program surcharge imposed as specified in Section 346.657, Wisconsin Statutes, and any amendments thereto. The safe ride program surcharge shall be collected by the City Treasurer and transmitted by the City as provided in Section 346.657(2)(b), Wisconsin Statutes.

13. Dispositions for Juveniles. Pursuant to §938.17(2)(cm), Wis. Stats., the Municipal Judge may impose the following dispositions upon a juvenile for a violation of City Ordinances:

a. Any disposition allowed under Chapter 48, Wis. Stats.;

b. §938.343(2), Wis. Stats.

c. §938.343(3), Wis. Stats.

CODE OF GENERAL ORDINANCES, 2021 - KENOSHA, WISCONSIN

- d. §938.343(4), Wis. Stats.
- e. §938.343(10), Wis. Stats.
- f. §938.344, Wis. Stats.
- g. §938.361, Wis. Stats.

Any or all of the above listed dispositions may be used in any combination when imposed by a Municipal Judge.

1.056 ELIGIBILITY FOR APPOINTMENT TO CITY BOARDS, COMMISSIONS, AUTHORITIES AND COMMITTEES

Except as otherwise provided for within this Ordinance and the Ordinances establishing individual City Boards, Commissions, Authorities or Committees, and except as provided in enabling State legislation, no person shall be appointed or reappointed, or remain in office after appointment or reappointment to any City Board, Commission, Authority or Committee, unless he or she shall be and remain a resident of the City of Kenosha, Wisconsin.

Notwithstanding the above, and except for the City Plan Commission, Board of Police and Fire Commissioners, Legislative Commission, Board of Review and the Zoning Board of Appeal, twenty (20%) percent of the full membership of any Board, Commission, Authority or Committee may reside outside the limits of the City, provided they reside within the limits of the County.

Any person appointed to any City Board, Commission, Authority, or Committee who is required under this Ordinance to be and remain a resident of the City, or County under the twenty (20%) percent exception, shall forfeit their office, as a matter of law, upon moving outside of the limits of the City, or County, where applicable, the vacancy to be effective following notice to the member and an opportunity of the member to be heard, upon any such Board, Commission, Authority or Committee, adopting a Resolution declaring the office vacant.

This Ordinance does not apply to special purpose Committees of limited duration established by Resolution or to the City of Kenosha Commission on the Arts.

Any member of any Board, Commission, Authority or Committee holding office on the effective date of this Ordinance, but not meeting its residency requirements, shall be permitted to continue their current term of office.

1.06 CITY BOARDS AND COMMISSIONS. Each member of a City Board or Commission shall take and file the official oath prior to assuming the position.

A. City Plan Commission. A City Plan Commission is hereby created pursuant to and in accordance with Section 62.23, Wisconsin Statutes, which is incorporated herein by reference, with the exception that, as authorized by Section 62.23 (1), Wisconsin Statutes, the composition of said body shall consist of the Mayor, who shall be its chairperson and presiding officer, the President of the Common Council, who shall be its vice chairperson, a member of the Board of Park Commissioners to be elected by said Commission, a member of the Committee on Public Works (Board of Public Works) to be elected by the Committee (Board) of Public Works, and six (6) citizens appointed by the Mayor and approved by the Common Council who shall be of recognized experience and qualifications. In the event the President of the Common Council is unable or unwilling to serve, he/she shall immediately notify the Mayor and nominate a member of the Common Council to fill the position. The Mayor shall appoint a member of the Common Council to fill the position, subject to the confirmation of the Common Council.

The terms of citizen members shall be staggered over a three (3) year period of time so that the terms of no more than two (2) members shall expire in any given year.

The Commission shall perform the functions prescribed in Section 62.23(2), Wisconsin Statutes.

B. Board of Police and Fire Commissioners. (See §62.13, Wisconsin Statutes.)

C. Library Board and Museum Board.

1. Library Board. (See §§43.52 to 43.58 Inclusive of the Wisconsin Statutes.) (Also see Chapter II, of these Ordinances for Library Tax.)

2. Museum Board. (See Charter Ordinance No.(s) 25 and 32 and Wisconsin Statutes §§229.11 to 229.18 inclusive.)

D. Board of Zoning Appeals - Zoning Ordinance.

E. Human Relations Commission.

1. A community relations-social development commission hereafter to be known as the Kenosha Commission on Human Relations, of the City of Kenosha, Wisconsin, is hereby created pursuant to the authority of §66.0125 of the Wisconsin Statutes.

2. Purpose: The purpose of the Commission is to study, analyze and recommend solutions for the major social, economic, and cultural problems which affect people residing or working within the City of Kenosha, including, without restriction, because of enumerations, problems of the family, youth, education, the aging, juvenile delinquency, health and zoning standards, and discrimination in housing, employment and public accommodations on the basis of sex, race, religion, color, handicap, national origin, marital status, lawful source of income, age or ancestry.

3. Powers: The Commission shall have the following functions, powers and duties:

a. To meet and function at any place within the City as it may select; to appoint committees to carry out any of its investigatory and research functions.

b. To request additional persons to serve as special advisors to the Commission.

c. To make such recommendations to agencies, officers and bodies of the City and other governmental agencies, officers and bodies as may be deemed advisable in aid of the purpose of this Ordinance.

d. To receive complaints alleging discrimination because of race, color, sex, handicap, religion, marital status, lawful source of income, age, ancestry, or national origin; to make such investigations and to hold such hearings as are required to establish the facts; to require the attendance of witnesses, and their production of documentary evidence, at such hearings; and to administer oaths to persons testifying before it.

e. To publish the findings of the Commission with respect to any complaint if such publication is deemed advisable and approved by a majority of the Commission's members.

f. To conduct such research and to issue such publication as in its judgment will promote good will and minimize or eliminate discrimination because of race, creed, color, sex or national origin.

g. In general, to act as an advisory, conciliatory and investigating agency on all matters threatening the general welfare by reason of discrimination.

h. To cooperate with State and Federal agencies and nongovernmental organizations having similar or related functions.

i. To examine the need for publicly and privately sponsored studies and programs in any field of human relationship which will aid in accomplishing the foregoing objectives, and initiate such public programs and studies and participate in and promote such privately sponsored programs and studies.

4. Appropriation and Allotment of Funds to the Commission: The acting government of the City of Kenosha shall make an allocation in its yearly budget for funds for the use of the Kenosha Commission on Human Relations in the proper performance of its activities and shall make further allocations for the use of the Commission as required by the Commission for any additional or special function which is deemed necessary or proper.

5. Composition of Commission: The Commission shall be nonpartisan and composed of citizens residing in the City of Kenosha, including representatives of the clergy and minority groups. The Commission shall consist of seven (7) members, each appointed to a three year term. Hereafter, as terms expire, appointments shall be made by the Mayor, subject to confirmation by the Common Council. A vacancy occurring otherwise than by expiration of a term shall be filled by appointment, as above, of a new member for the unexpired term. Four (4) members shall constitute a quorum for the purpose of conducting the business thereof. Members of the Commission shall serve without compensation. Members of the Human Relations Commission, as it exists at the time of passage of this Ordinance, shall automatically be members of this Commission until such time as their existing terms expire. Every person appointed as a member of the Commission shall take and file the official State Oath.

6. Open Meetings: All meetings of the Commission and its consulting Committees shall be publicly

held and open to all citizens at all times, as required by §19.81 of the Wisconsin Statutes.

7. Officers-ByLaws: The Commission shall elect a chairman, vice-chairman, secretary and treasurer; may adopt from time to time bylaws and rules of procedure fixing the time and place of meeting, prescribing the manner of keeping records and treating other matters.

8. Designation of Commission as Cooperating Agency Under Federal Law:

a. The Commission shall be the official agency of the City of Kenosha to accept assistance under the Federal economic opportunity acts. However, no assistance shall be accepted with respect to any matter to which objection is made by the Common Council.

b. The Commission shall be the official agency of the City of Kenosha to accept assistance from the community relations service of the United States Department of Justice under Title X of the Federal Civil Rights Act of 1964, as subsequently amended and supplemented by new Federal legislation, as it provides for assistance to communities in resolving disputes, disagreements or difficulties relating to discriminatory practices based on race, color, sex or national origin which may impair the rights of persons in a municipality under the Constitution or laws of the United States or which affect or may affect interstate commerce.

c. The Commission shall be the official agency of the City of Kenosha to cooperate with and accept assistance from the United States Department of Housing and Urban Development under Title VIII of the Civil Rights Act of 1968, as amended, as it provides for referral of complaints and providing assistance to cooperating State and local agencies charged with the administration of fair housing laws. The Commission may, subject to approval of the Common Council, enter into written agreements with the Department for that purpose.

9. If any part of this Ordinance shall be declared invalid, the balance shall remain in full force and effect.

F. Kenosha Transit Commission.

1. Created.

a. There is created a Kenosha Transit Commission. Pursuant to §66.1021, Wisconsin Statutes, there is hereby created the "KENOSHA TRANSIT COMMISSION" for the establishment, maintenance and operation of a comprehensive unified local transportation system, the major portion of which is or is to be located within or the major portion of the service of which is or is to be supplied to the inhabitants of the City of Kenosha, and which system is used or to be used chiefly for the public transportation of persons.

b. The Transit Commission shall be responsible for the management, control and operation of municipal parking lots, facilities and systems as specified in §§66.0805 and 66.0829, Wisconsin Statutes. The Commission shall establish such fees and charges for parking privileges at parking meters in such parking lots as it shall determine reasonable and shall recommend to the Council the adoption of such Ordinances as will promote and assure the proper use of such lots.

c. The Commission shall recommend to the Council the number, size and location of parking lots throughout the City which are to be purchased. In such recommendation the Commission shall recommend whether the payment therefore shall be from funds on hand or accruing from parking or transit revenues, or from contributions from the general City funds or from proceeds of revenue bonds.

2. Definitions.

a. "Transit Commission" or "Commission" means the Transit Commission created hereunder.

b. "Comprehensive Unified Local Transportation System" means a transportation system comprised of motor bus lines and any other local public transportation facilities, the major portions of which are within the City of Kenosha.

c. "Facilities and Equipment" includes land (but not public highways), buses and other rolling stock, and other real or personal property.

d. "Public Transportation" means transportation by bus, rail or other conveyance, either publicly or privately owned, which provides to the public general or special service (but not including charter or sight-seeing service on a regular and continuing basis except governmental units).

3. Composition. The Transit Commission shall consist of seven (7) members, to be appointed by the Mayor and approved by the Council, one of whom shall be elected Chairman by the Commission. Two (2) members shall be Aldermen.

4. Term and Qualification.

a. The first members of the Transit Commission shall be appointed for staggered terms; two members for one year; two members for two years; three members for three years. The term of office of each member thereafter appointed shall be three years.

b. No person holding stocks or bonds in any corporation subject to the jurisdiction of the Transit Commission, or who is in any other manner directly or indirectly pecuniarily interested in any such corporation, shall be a member of the nor employed by the Transit Commission.

5. Employees and Supplies. The Transit Commission may appoint a secretary and employ such accountants, engineers, experts, inspectors, clerks and other employees and fix their compensation, and purchase such furniture, stationery and other supplies and materials, as are reasonably necessary to enable it properly to perform its duties and exercise its powers.

6. Powers.

a. The Transit Commission may adopt rules relative to the calling, holding and conduct of its meetings, the transaction of its business, the regulation and control of its agents and employees, the filing of complaints and petitions and the service of notices thereof and conduct hearings.

b. For the purpose of receiving, considering and acting upon any complaints or applications which may be presented to it for the purpose of conducting investigations or hearings on its own motion the Transit Commission shall hold regular meetings at least once a month and special meetings on the call of the chairman or at the request of the Common Council.

c. The Transit Commission may adopt a seal, of which judicial notice shall be taken in all courts of this State. Any process, writ, notice or other instrument which the commission may be authorized by law to issue shall be deemed sufficient if signed by the secretary of the commission and authenticated by such seal. All acts, orders, decisions, rules and records of the commission, and all reports, schedules and documents filed with the commission may be proved in any court in this State by a copy thereof certified by the secretary under the seal of the commission.

7. Comprehensive Unified Local Transportation System. The jurisdiction, powers and duties of the Transit Commission shall extend to the comprehensive unified local transportation system for which the commission is established including any portion of such system extending into adjacent or suburban territory within this State lying outside of the City of Kenosha not more than 30 miles from the nearest point marking the corporate limits of the City of Kenosha.

8. Finances. All revenue received from Parking meters or derived from operation of parking lots and the unified transportation system shall be kept in a separate and segregated fund. Such revenues shall only be used for the maintenance, operation, improvement and acquisition of parking meters and of parking lots; and for general street and highway maintenance, repair and construction; and for traffic regulations and for promoting, maintaining, and supporting a public mass transit system.

The Transit Commission may borrow money for the acquisition of facilities and equipment and may issue revenue bonds according to the provisions of §66.0621, Wisconsin Statutes.

9. Acquisition of Facilities and Equipment. Initial acquisition of the facilities and equipment for the establishment of and to comprise the comprehensive unified local transportation system shall be subject to §66.0803 or Chapter 197 of the Wisconsin Statutes.

10. Study Group. The Transit Commission may study and report to the Common Council on the feasibility of contracting with private organizations or other units of government for transportation services, all as provided by the Wisconsin Statutes.

11. Should any section, paragraph, sentence, clause or phrase of this Section be declared unconstitutional or invalid or be repealed, it shall not effect the validity of this Ordinance as a whole or any part thereof other than the part so declared to be invalid.

G. Board of Public Works.

1. The Board of Public Works shall be and consist of the Committee on Public Works of the Common Council.

2. Sections 62.14 (2), (4), (5), (6) and (7) of the Wisconsin Statutes are hereby adopted to the same

force and effect as if they were set out in full herein.

H. Board of Water Commissioners.

1. Pursuant §66.0805 of the Wisconsin Statutes there is hereby created a Board of Water Commissioners which shall have charge and management of the waterworks utility.
2. The Board of Water Commissioners shall be the Committee on Public Works of the Common Council.
3. Sections 66.0805 (3), (4) and (5) of the Wisconsin Statutes are hereby adopted to the same force and effect as if they were set out in full herein.

I. Board of Absentee Ballot Canvassers. Pursuant to Sections 7.52 and 7.53(2m), Wisconsin Statutes, there is hereby created a "Board of Absentee Ballot Canvassers".

1. **Purpose.** The purpose of the Board of Absentee Ballot Canvassers is to canvass all absentee ballots at all elections held within the City of Kenosha.
2. **Members.** The Board of Absentee Ballot Canvassers shall consist of the City Clerk/Treasurer, or his/her designee, and two (2) other qualified electors of the City appointed by the City Clerk/Treasurer. The City Clerk/Treasurer may appoint additional inspectors to assist the Board in canvassing absentee ballots, pursuant to Section 7.30(2)(a), Wisconsin Statutes. The City Clerk/Treasurer shall provide at least forty-eight (48) hours prior notice of any meeting to be held pursuant to this Ordinance.
3. **Term.** The term of members shall be for a period of two (2) years, commencing on January 1 of each odd-numbered year.

J. Board of Park Commissioners.

1. There is hereby created a Board of Park Commissioners pursuant to §27.08 of the Wisconsin Statutes.
2. Said Board shall consist of the Committee on Public Welfare of the Common Council.
3. Said Board shall have all the powers and duties conferred upon it by the Statutes of Wisconsin and the Ordinances of the City of Kenosha.

K. Stormwater Utility Commission. There is hereby created a Stormwater Utility Commission, which shall be the Committee on Stormwater Utility of the Common Council.

1. **Purpose.** The purpose of the Stormwater Utility Commission is to govern, manage, control, improve and care for stormwater management services, systems and facilities.
2. Said Commission shall have all the powers and duties conferred upon it by the Code of General Ordinances of the City of Kenosha, and the Wisconsin State Statutes.

L. Terms of Citizens on Boards and Commissions. The Common Council shall not approve or confirm the reappointment of a citizen member to any board or commission which would result in such citizen being a member on such board for more than one (1) full term where the term of office is five (5) years or more.

The Common Council shall not approve or confirm the reappointment of a citizen member to any board or commission for more than two (2) consecutive full terms, if the term is less than five (5) years.

The contrary provisions of this Subsection notwithstanding, a citizen member of a board or commission may be appointed to, and confirmed for, a board or commission for one (1) full term of five (5) years or more, or for up to two (2) full terms each of five (5) years or less, immediately ensuing service by the citizen member of a partial term of another, if such partial term was for an unexpired term of less than one-half (1/2) of a full term.

CODE OF GENERAL ORDINANCES, 2021 - KENOSHA, WISCONSIN

A citizen member is defined to be a person who is not an employee or officer of the City.

A citizen member whose term has expired, irrespective of the above, may be appointed on an interim basis, not to exceed six months, to the same board or commission until such time as a qualified successor can be appointed. If there is any conflict of this provision with State Law, this paragraph shall be interpreted so as to conform to State law. Interim appointments shall be made in the same manner as the original appointment, each such appointment being substantially worded: "_____ is hereby appointed to continue his/her position on the _____ Board/Commission until a qualified successor can be appointed, but in no event shall this appointment exceed six (6) months."

The time period served on any such interim appointment shall be deducted from the term during which such interim appointment was served and a permanent appointee to said term shall be appointed for the balance of the term remaining.

The above restrictions on terms of office shall not apply to the Historic Preservation Commission due to the fact that there is a shortage of qualified and competent personnel available and willing to accept appointments to said Commission.

P. Legislative Commission.

1. Title. There is hereby created the Legislative Commission.

2. Members. The membership of said Commission shall be: the Common Council President and the respective Chairperson of the Committee on Finance, the Committee on Public Works, the Committee on Public Safety and Welfare, the Committee on Stormwater Utility, the Committee on Licenses/Permits, and the Board of Park Commissioners. In the event a member is unable or unwilling to serve, he/she shall immediately appoint a member in the manner as follows:

a. Common Council President. The Common Council President shall appoint a member of the Common Council who is not serving on the Commission.

b. Chairperson of Committees. The Chairperson of a Committee shall appoint a member of his/her Committee.

3. Officers. The Commission shall elect a chairperson and vice chairperson from among its members. The Mayor shall appoint a City employee to act as Secretary for the Commission, at no additional compensation to be paid to said employee, other than compensatory time off, unless such compensation is authorized in advance by Resolution of the Common Council.

4. ByLaws. The Commission may, from time to time, adopt bylaws and rules of procedure fixing the time and place of meeting, prescribing the manner of keeping records, and treating other matters.

5. Duties. The Commission:

a. Shall review, study and report to the Common Council on proposed or pending State legislation which will or may affect the City.

b. May appoint one or more of its members to appear before the State Legislature or any of its Committees or before any State body possessing legislative authority for the purpose of presenting evidence or argument in favor of or against any matter under consideration by such State body which will or may affect the City. The Commission, however shall not have exclusive authority in this regard and shall not involve itself in any litigation pending before any Court or judicial or quasi judicial body.

c. May hold public or, where authorized by law, executive hearings to review any pending or proposed State legislation which will or may affect the City.

6. Appropriation and Allotment of Funds to the Commission. The Common Council may, from time to time, allocate such funds as said Council deems necessary and appropriate for the use of the Commission in the performance of duties herein relevant.

Commission members shall be entitled to per diem and expenses as provided in §1.01, Ordinances. When available, all expenses receipts shall be furnished for out-of-City trips.

Q. Commission on Women's Issues.

1. Title. There is hereby created the "Commission On Women's Issues".

CODE OF GENERAL ORDINANCES, 2021 - KENOSHA, WISCONSIN

2. Purpose. The purpose of the Commission shall be to compile, coordinate, and make available to the public information on women's issues and establish a databank of names of women who are interested in governmental appointments in order to further the representation of women in government.

3. Members. There shall be fifteen (15) members who shall be appointed by the Mayor, and confirmed by the Common Council, who shall be representative of the community and concerned about the status of women in society and the impact of governmental actions upon women.

4. Term. The term of members shall be three (3) years, commencing on August 1st. The terms shall be staggered and the initial terms shall be as follows: Five (5) members shall serve for three (3) years, five (5) members shall serve for two (2) years, and five (5) members shall serve for one (1) year.

5. Officers. The Mayor shall appoint a chairperson and the Commission shall elect a vice-chairperson from among its members. The Mayor may appoint a City employee to act as Secretary for the Commission, at no additional compensation to be paid to said employee, other than compensatory time off, unless such compensation is authorized in advance by the Common Council.

6. By-Laws. The Commission may, from time to time, adopt bylaws and rules of procedure fixing the time and place of meeting, prescribing the manner of keeping records, and treating other matters.

7. Duties. The Commission shall have the following duties:

a. to create a databank of names of women who are interested in governmental appointments, and serve as a resource agency in response to requests from the Mayor's office or legislative bodies which appoint advisory committees, task forces, work groups, committees, commissions or boards for the names of women interested in governmental appointment.

b. to identify the social and economic concerns of women.

c. to hold public hearings and conferences, conduct, research and distribute publications consistent with the purpose of the Commission.

d. to identify the concerns of minority women, such as racism, employment, health and childcare.

e. to enlist and encourage the cooperation of local agencies, organizations, councils, and other groups, both public and private, to effectuate the purpose of the Commission.

f. to report to the Mayor as requested and to render an annual report to the Mayor and Common Council summarizing its work.

8. Gifts/Grants. The Commission may apply for grants from the United States, the State of Wisconsin, and their agencies, and accept donations from any person, firm, party or corporation, of services, equipment, supplies, materials or funds and utilize said donations to effectuate the purpose of the Commission.

9. Appropriation And Allotment Of Funds. The Common Council may, from time to time, allocate such funds as said Council deems necessary and appropriate for the use of the Commission in the performance of duties herein relevant. Out-of-City trips must be approved, in writing, in advance, by the Mayor, and all expense receipts furnished, when available.

R. Keep Kenosha Beautiful Commission.

1. Title. There is hereby created the "Keep Kenosha Beautiful Commission".

2. Purpose. The purpose of the Keep Kenosha Beautiful Commission is to promote a clean environment and to promote the recycling of solid waste in the City.

3. Members. There shall be eleven (11) members who shall be appointed by the Mayor, and confirmed by the Common Council, who shall be representative of the community and concerned about the environment and recycling.

4. Term. The term of members shall be three (3) years, commencing on May 1st. The terms shall be staggered and the initial terms shall be as follows: Five (5) members shall serve for three (3) years; five (5) members shall serve for two (2) years; and five (5) members shall serve for one (1) year.

5. Officers. The Mayor shall appoint a chairperson and the Commission shall elect a vice-chairperson from among its members. The Mayor may appoint a City employee to act as Secretary for the Commission, at no additional compensation to be paid to said employee, other than compensatory time off, unless such compensation is authorized in advance by the Common Council.

6. By-Laws. The Commission may, from time to time, adopt bylaws and rules of procedure fixing the time and place of meeting, prescribing the manner of keeping records, and treating other matters.

7. Duties. The Commission shall have the following duties:

- a. to promote public interest in the environment.
- b. to initiate, plan and coordinate programs for litter control in conjunction with and in cooperation with citizens, government, business and industries on a substantial basis.
- c. to implement and maintain the Keep America Beautiful System.
- d. to investigate and develop plans for improving the cleanliness of the City by beautifying the streets, highways, alleys, river banks, lakeshore lots, yards and other similar places on both public and private property within the City and for the removal and elimination of trash and other debris therefrom.
- e. to encourage the placing, planting and preservation of trees, flowers, plants, shrubs and other objects and ornamentation in the City.
- f. to advise and recommend plans for the beautification of the City.
- g. to promote recycling within the City.

8. Gifts/Grants. The Commission may apply for grants from the United States, the State of Wisconsin, and their agencies, and accept donations from any person, firm, party or corporation, of services, equipment, supplies, materials or funds, and utilize said donations to effectuate the purpose of the Commission.

9. Appropriation And Allotment Of Funds. The Common Council may, from time to time, allocate such funds as said Council deems necessary and appropriate for the use of the Commission in the performance of duties herein relevant. Out-of-City trips must be approved, in writing, in advance, by the Mayor, and all expense receipts furnished, when available.

S. Mayor's Youth Commission.

1. Title. There is hereby created a "Mayor's Youth Commission".

2. Purpose. The purpose of the Commission shall be to assist in the identification of societal problems as they directly affect minors and young adults to propose solutions to such problems to any appropriate agency of government or private agency, to identify and recognize worthy organizations for minors and young adults; to identify and recognize individual minors and young adults who excel in any field of worthy endeavor; and to generally act as a resource for youth in City government matters.

3. Members. There shall be nine (9) members who shall be appointed by the Mayor and confirmed by the Common Council who shall be representative of the community and concerned about the positive image of youth in the City of Kenosha. In making appointments, the Mayor shall strive to appoint four (4) members under the age of twenty-three (23) at the time of confirmation by the Common Council. Of the remaining five (5) members, one (1) shall be an alderperson and one (1) shall be appointed from the Police Department.

4. Term. The term of the members shall be two (2) years commencing on November 1. The terms shall be staggered.

5. Officers. The Mayor shall appoint a chairperson and the Commission shall elect a vice-chairperson from among its members. The Mayor may appoint a City employee to act as secretary for the Commission at no additional compensation to be paid to said employee other than compensatory time off unless such compensation is authorized in advance by the Common Council.

6. By-Laws. The Commission may, from time to time, adopt bylaws and rules of procedure fixing the time and place of meeting, prescribing the manner of keeping records and treating other matters.

7. Duties. The Commission shall have the following duties:

- a. To create and maintain a databank of all bona fide youth organizations and their address and contact person if any, servicing youth of the City of Kenosha which have youth as their primary membership and officers.
- b. To publicize, promote and, in appropriate instances award financial gifts to bona fide youth organizations.
- c. To identify and recommend to the Mayor for commendation various individuals who are under the age of twenty-one (21) and who excel in any field of worthy endeavor or who are any age and have contributed in an outstanding manner to the youth of the City of Kenosha in a manner outside the scope of his or her employment.
- d. To identify the social and economic concerns of youth and make appropriate recommendations to public or private agencies on how the agency may better serve youth.
- e. To report to the Mayor as requested.
- f. To enlist and encourage the cooperation of local agencies, organizations councils, and other public or private groups, to effectuate the purpose of this Commission.
- g. To make recommendations to youth organizations as to how they may better serve the City by suggesting service projects to enhance the City when said recommendation is solicited by the organization.
- h. To hold public hearings and conferences and conduct research consistent with the purpose of the Commission.

8. Gifts/Grants. The Commission may apply for grants from the United States, the State of Wisconsin, and their agencies, and accept the donations from any person, firm, party or corporation, of services, equipment, supplies, materials or funds and utilize said donations to effectuate the purpose of the Commission.

9. Appropriation and Allotment of Funds. The Common Council may from time to time, allocate such funds as said Council deems necessary and appropriate for the use of the Commission in the performance of duties herein relevant. Out-of-City trips must be approved, in writing, in advance, by the Mayor, and all expense receipts furnished when available.

T. City of Kenosha Commission on the Arts.

1. Title. There is hereby created a "City of Kenosha Commission on the Arts."

2. Purpose. The purpose of this Commission is to support economic development of creative and expressive endeavors by developing collaborative relationships between artists, musicians, businesses, government and other arts organizations.

3. Members. There shall be eleven (11) members who shall be appointed by the Mayor and confirmed by the Common Council. In making appointments, the Mayor shall strive to appoint four (4) members from the academic field and two (2) members from the business field to the Commission and further shall strive to appoint representatives from: Carthage College, University of Wisconsin - Parkside, Gateway Technical College, Kenosha Unified School District, Kenosha Area Convention and Visitors Bureau, Kenosha Area Business Alliance (KABA), and Kenosha Area Chamber of Commerce. In addition to the representatives appointed from some or all of the same institutions listed in the prior sentence, the Mayor will appoint an Alderperson to serve on the Commission and shall appoint the remainder of the Commissioners from the public at large, who has a demonstrable interest in the fine arts.

4. Term. The term of the members shall be two (2) years commencing on November 1. The terms shall be staggered and the initial term shall be as follows: Six (6) members shall serve for two (2) years and five (5) members shall serve for one (1) year.

5. Officers. The Commission will elect a chairperson and a vice-chairperson from among its members.

6. By-Laws. The Commission may, from time to time, adopt bylaws and rules of procedure fixing the time and place of meeting, prescribing the manner of keeping records and treating other matters.

7. Duties. The Commission has the following duties: The Commission brings together representatives from the arts, music, businesses, and government in the City of Kenosha for the purpose of networking and

supporting a robust creative economy.

- Specifically, the Commission will sponsor a networking activity on a yearly basis to bring the aforementioned parties together to learn and share each other's work and goals.
- More generally, the Commission will initiate, sponsor, and/or support public programs in the arts and culture within the time constraints imposed by an all-volunteer Commission.
- The Commission will offer advice and counsel to the City of Kenosha as it plans for the future.
- The Commission's monthly meetings will function as a public site where all citizens of Kenosha may share their art and cultural activities.

The Commission on the Arts acts in an advisory capacity to the Mayor and the Common Council.

8. Gifts/Grants. The Commission may apply for grants from the United States, the State of Wisconsin, and their agencies, and accept the donations from any person, firm, party or corporation, of services, equipment, supplies, materials or funds and utilize said donations to effectuate the purpose of the Commission subject to Common Council approval.

9. Appropriation and Allotment of Funds. The Common Council may from time to time, allocate such funds as said Council deems necessary and appropriate for the use of the Commission in the performance of duties herein relevant. Out-of-City trips must be approved, in writing, in advance, by the Mayor, and all expense receipts furnished when available.

U. HOME Program Commission.

1. Title. There is hereby created a "HOME Program Commission".

2. Purpose. The purpose of the HOME Program Commission is to solicit, review and recommend projects to be funded by HOME Investment Partnership Program grants from the United States Department of Housing and Urban Development which will strengthen public-private partnerships and provide more affordable rental and homeownership housing through acquisition, rehabilitation, new construction and any other eligible activities under the HOME Program.

3. Members. The composition of the HOME Program Commission shall consist of the members of the Community Development Block Grant Committee established in Section 1.06X.

4. Term. The terms of office shall be consistent with the terms of office for the respective terms of the members of the Community Development Block Grant Committee.

5. Officers. The Commission shall elect from its members the chairperson and vice chairperson annually at the first meeting in May of each year. The Mayor may appoint a City employee to act as secretary for the Commission at no additional compensation to be paid to said employee other than compensatory time off unless such compensation is authorized in advance by the Common Council.

6. By-Laws. The Commission may, from time to time, adopt bylaws and rules of procedure fixing the time and place of meeting, prescribing the manner of keeping records and treating other matters.

7. Duties. The Commission shall:

- a. Annually solicit, review and recommend to the Common Council projects to be funded with Federal HOME Program grant funds.
- b. Develop a program description for Common Council approval to be submitted to the U.S. Department of Housing and Urban Development.
- c. Meet periodically to review program activities and results.

8. Appropriation and Allotment of Funds to the Commission. The Common Council may, from time to time, allocate such funds as said Council deems necessary and appropriate for the use of the Commission in the performance of duties herein relevant. Out-of-City trips must be approved, in writing, in advance, by the Mayor, and all expenses and receipts furnished, when available.

V. Board of Review.

1. **Title.** There is hereby created a "Board of Review" in accordance with Section 70.46, Wisconsin Statutes.
2. **Purpose.** The purpose of the Board of Review shall be to conduct proceedings and act in accordance with Section 70.47, Wisconsin Statutes, and such other provisions of Chapter 70, Wisconsin Statutes, as may be applicable.
3. **Members.** There shall be five (5) members appointed by the Mayor and confirmed by the Common Council. The membership shall consist of citizens who are residents of the City, and may include public officers and employees who are residents of the City of Kenosha, except that the Assessor and employees of the Assessment Department may not be members. Members shall serve without salary.
4. **Term.** The term of members shall be five (5) years, which shall be staggered by creating initial terms for a period of one (1), two (2), three (3), four (4) and five (5) years, respectively.
5. **Officers.** The Board shall elect a chairperson and a vice-chairperson from among its members at its initial meeting and annually at its first meeting of each calendar year. The Mayor may appoint a City employee to act as Secretary for the Commission at no additional compensation to be paid to said employee, other than compensatory time off, if applicable, unless such compensation is authorized in advance by the Common Council.
6. **By-Laws.** The Board may, from time to time, adopt bylaws and rules of procedure fixing the time and place of meeting, prescribing the manner of keeping records, and treating other matters.
7. **Duties.** The Board shall have the duties specified in Section 70.47, Wisconsin Statutes, and such other provisions of Chapter 70, Wisconsin Statutes, as may be applicable.

W. Board of Assessors.

1. **Title.** There is hereby created a "Board of Assessors" in accordance with Section 70.075, Wisconsin Statutes.
2. **Purpose.** The purpose of the Board of Assessors shall be to conduct proceedings and act in accordance with Section 70.075, Wisconsin Statutes, and such other provisions of Chapter 70, Wisconsin Statutes, as may be applicable.
3. **Members.** There shall be five (5) members appointed by the City Assessor and confirmed by the Common Council. The membership shall consist of the City Assessor and such assistant assessors, appraisers and other expert technical personnel as the City Assessor may appoint.
4. **Term.** The term of members shall be indefinite, subject to termination without cause by the City Assessor.
5. **Officers.** The City Assessor shall be the chairperson and shall appoint a vice chairperson from among its members. The City Assessor may appoint a member or an employee of the Assessment Department to act as Secretary for the Board.
6. **By-Laws.** The Board may, from time to time, adopt bylaws and rules of procedure fixing the time and place of meetings, prescribing the manner of keeping records, and treating other matters.
7. **Duties.** The Board shall have the duties specified in Section 70.075, Wisconsin Statutes, and such other provisions of Chapter 70, Wisconsin Statutes, as may be applicable.

X. Community Development Block Grant Committee.

1. **Title.** There is hereby created the "Community Development Block Grant Committee".

2. Purpose. The purpose of the Community Development Block Grant Committee shall be to make recommendations respecting the expenditure of Community Development Block Grant funds.

3. Members. There shall be seven (7) members; three (3) members of the Finance Committee of the Common Council; three (3) members of the City Plan Commission; and one (1) citizen of the City. All members shall be appointed by the Mayor and confirmed by the Common Council.

4. Term. The term of members shall be: from the Finance Committee, for the duration of their two (2) year term of office as alderperson; from the City Plan Commission, for the balance of their appointed term; for the citizen member, three (3) years. Any member from the Finance Committee or City Plan Commission who shall for any reason cease to hold such position shall cease to be a member of the Committee. There shall be no limit on the number of consecutive terms of members.

5. Officers. The Committee shall elect a chairperson and vice chairperson from among its members at its initial meeting and annually at its first meeting of each calendar year. The Director of City Development shall appoint an employee of the Department of City Development to act as Secretary for the Committee at no additional compensation to be paid to said employee, other than compensatory time off, if applicable, unless such compensation is authorized in advance by the Common Council.

6. By-Laws. The Committee may, from time to time, adopt by-laws and rules of procedure fixing the time and place of meeting, prescribing the manner of keeping records, and treating other matters.

7. Duties. The Committee shall have the following duties:

- a. Solicit comments from the public pertaining to the housing and community development needs of the City.
- b. Recommend to the City Plan Commission and Finance Committee a five (5) year Consolidated Plan.
- c. Recommend to the City Plan Commission and Finance Committee an annual Fund Allocation Plan.
- d. Solicit proposals for the use of Community Development Block Grant Funds, annually.
- e. Recommend to the City Plan Commission and Finance Committee expenditure of the Community Development Block Grant Funds.
- f. Provide recommendations on the reprogramming of unexpended Community Development Block Grant Funds, as needed.

Y. Kenosha Hometown Heroes Commission.

1. Title. There is hereby created the "Kenosha Hometown Heroes Commission".

2. Purpose. Every year men and women of the City of Kenosha proudly serve in our military, preserving the freedoms and democracy that our country provides. The purpose of the Commission shall be to identify and recognize as Hometown Heroes, worthy men and women who have served or are currently serving in the United States Armed Forces who were born in, currently reside in or have previously resided for ten (10) years or more at any time, in the City of Kenosha, Wisconsin.

3. Members. There shall be seven (7) members. One (1) shall be an alderperson, with preference given to an alderperson who is a veteran of the United States Armed Forces when possible, six (6) shall be citizens, four (4) of whom shall be veterans of the United States Armed Forces. All members shall be appointed by the Mayor and confirmed by the Common Council.

4. Term. The term of the members shall be two (2) years commencing on September 1. The terms shall be staggered and the initial term will be September 1, 2014, shall be as follows: One (1) member who is an alderperson shall serve for two (2) years; three (3) citizens, two (2) of which are veterans shall serve for two (2) years; three (3) citizens, two (2) of which are veterans shall serve one (1) year. There shall be no limit on the number of consecutive terms of members.

5. Officers. The Mayor shall appoint a chairperson and the Commission shall elect a vice-chairperson from its members. The Mayor may appoint a City employee to act as secretary for the Commission at no additional compensation to be paid to said employee other than compensatory time off unless such compensation is authorized in advance by the Common Council.

6. By-Laws. The Commission may, from time to time, adopt bylaws and rules of procedure fixing the time and place of meeting, prescribing the manner of keeping records and treating other matters.

7. Duties.

a. To review nominations provided by the public to identify Kenosha's Hometown Heroes who will be recognized quarterly at regular meeting of the Common Council.

b. To select a Hometown Hero of the year and recognize that person at the last regular meeting of the Common Council of the calendar year in which they are selected.

Z. Aldermanic Notice

Whenever a City Board or Commission, or personnel authorized by the Board or Commission, has scheduled a public meeting, which is not a regularly scheduled meeting of the Board or Commission, separate aldermanic written notice shall be given by the Board or Commission to each alderperson at least 72 hours prior to the commencement of such meeting unless for good cause such notice is impossible or impractical, in which case shorter notice may be given, but in no case may the notice be provided less than two (2) hours in advance of the meeting. The written notice shall be on paper and in electronic mail (e-mail) format. The affected alderperson(s) shall be required to give approval for their district. Receipt shall be presumed upon delivery to the aldermanic mailbox located within City Hall and upon sending an electronic message to the alderperson's City issued e-mail account. The notice shall announce the time, place and subject matter of the meeting. "Public Meeting" means the convening of members of a City Board or Commission for the purpose of meeting with the public to discuss a topic which is subject to the responsibility, authority, or duties delegated to the Board or Commission.

1.06 A.A. BOARD OF HOUSING APPEALS

1. Created. The Board of Housing Appeals is created, having the purpose and powers hereinafter set forth.

2. Membership of Board; Quorum and Officers. The Board of Housing Appeals shall consist of the five (5) non- alternate members of the Zoning Board of Appeals established in Subsection 9.02 of the Zoning Ordinance. The officers of the Board of Housing Appeals shall be the Chairperson, Vice Chairperson, who shall act in the absence of the Chairperson, and the Secretary, who shall act in the absence of the Vice Chairperson. The presence of three (3) members at the Board of Housing Appeals constitutes a quorum. The Director of the Department City Inspections shall provide for secretarial services for the Board of Housing Appeals.

3. Powers and Duties.

a. The Board of Housing Appeals may:

(1) Affirm or reverse, either in whole or in part, or modify any order, requirement, decision or determination appealed from

(2) make such other order, or provide such other relief as in the opinion of said Board of Housing Appeals ought to be made by the Code Official, as that term is defined in Chapter 16.

(3) Make rules of procedure for their operation that are not inconsistent with the Code of General Ordinances.

b. In carrying out its duties, the Board of Housing Appeals must:

(1) Interpret the provisions of Chapter 16 in such a way to carry out its intent and purpose.

(2) Not vary or modify any order that involves structural changes where such action will adversely affect the public health, safety or welfare

4. Disqualification of Member. A Board of Housing Appeals member may not hear an appeal in which that member has a personal, professional or financial interest.

5. Meetings. The Board of Housing Appeals shall meet upon notice from the Chairperson within thirty (30) days of the filing of an appeal, or at stated periodic dates and times.

6. Open Hearing and Deliberations. All hearings before the Board of Housing Appeals shall be open to the public. The appellant, the appellant's representative, the Code Officials and any Person whose interests are affected shall be given an opportunity to be heard.

7. Procedure. The Board of Housing Appeals may adopt and make available to the public, through its Secretary, rules of procedures. The Board of Housing Appeals, in holding hearings, shall not require compliance with strict rules of evidence, but shall mandate that only relevant evidence be received.

8. Records and Copies. The proceedings at such hearing, including the findings and decisions of the Board of Housing Appeals, shall be summarized, reduced to writing, and entered as a matter of public record in the Department. Such record shall also include a copy of every notice of violation and order issued in connection with the matter. Any Person aggrieved by the decision of the Board of Housing Appeals may seek further relief therefrom in any court of competent jurisdiction, as Provided by the laws of Wisconsin.

9. Office. The Department shall be the office of the Board of Housing Appeals.

B. Administration. The Code Official shall take immediate action to implement the decision of the Board of Housing Appeals.

1.065 KENOSHA AREA BUSINESS ALLIANCE, INC.

A. Recognition And Purpose. The Kenosha Area Business Alliance, Inc. (formerly Kenosha Area Development Corporation) is recognized as a without stock and not-for-profit Wisconsin Corporation created for the purpose to engage in any lawful activities authorized by Chapter 181 of the Wisconsin Statutes; to further economic development within the community of Kenosha, Wisconsin; to promote and assist the growth and development of businesses, specifically including small businesses in the community, to promote and provide for additional and maximum employment to aid the community by increasing business volume, by attracting industry to the community, and by encouraging the development of, and retention of, industry in the community and to lessen the burdens of government, and to act in the public interest.

B. Appropriation And Allotment Of Funds To Corporation. The Mayor is authorized to make an allocation in the Mayor's proposed yearly budget of funds for use of the Kenosha Area Business Alliance, Inc. in the proper performance of its activities, and may make further allocations for the use of the Corporation as requested and required by the Corporation, for any additional or special function which is deemed necessary or proper.

1.067 SISTER CITIES ASSOCIATION OF KENOSHA, WISCONSIN, INC.

A. Recognition And Purpose. The Sister Cities Association of Kenosha, Wisconsin, Inc. is recognized as a without stock and not-for-profit corporation created for the purpose of engaging in any lawful activities authorized by Chapter 181 of the Wisconsin Statutes, including, but not limited:

1. To cause the people of the City of Kenosha, Wisconsin, and the people of similar cities of foreign nations to acquire a consciousness of each other, to understand one another as individuals, as members of their community, as citizens of their country, and as part of the family of nations.

2. To foster as a consequence of such knowledge and consciousness, a continuing relationship of mutual concern between the people of the City of Kenosha, Wisconsin, and the people of similar cities of other nations.

3. To undertake both in seeking and in consequence of such consciousness and concern any activities and programs as will provide to one another appropriate aid and comfort, education and mutual understanding.

4. To participate as an organization in promoting, fostering and publicizing State and national programs of international municipal cooperation organizations, and thereby to encourage other organizations and residents of American communities to engage and participate in such programs, to foster and promote friendly relations and mutual understanding between peoples of American communities and peoples of friendly nations outside of the United States of America, and to act as a coordinating body, committee, agency or counsel among those organizations, groups and individuals desiring to and engaging in the activities of such international municipal cooperation organizations.

5. Provided that the corporation shall not in any way, directly or indirectly engage in the carrying on of propaganda or otherwise attempt to influence legislation.

B. Appropriation And Allotment Of Funds. The Common Council may, from time to time, allocate such funds as said Council deems necessary and appropriate for the use of the Corporation in the performance of duties herein relevant.

C. Administrative Services. The City of Kenosha may provide all necessary staff required by said Corporation for the Corporation's daily operations and activities in accordance with an Administrative Services Agreement agreed to and entered into by the City and the Corporation.

1.07 OFFICIAL BONDS AND OATHS

(See §§62.09 (4) and 19.07 of Wisconsin Statutes.)

1.08 COMPENSATION OF PERSONNEL

A. Police and Fire Departments. The members of the Police and Fire Departments shall be paid the sums that now are or may hereafter be fixed by the Council except that no compensation now paid to any member of these Departments shall be reduced without previous recommendation in writing by the Board of Police and Fire Commissioners.

B. Other Officers and Employees. The amount of basic compensation to be paid other officers and employees shall be fixed by the City Common Council in accordance with the Civil Service Ordinance and the Personnel Rules and Regulations promulgated thereunder.

C. Time of Payments. The compensation herein provided shall be paid semi-monthly except that employees by the hour or week may be paid weekly

1.09 MILITARY LEAVE OF ABSENCE

Leave of Absence for Military Service Granted. See §17.035 of the Wisconsin Statutes.

Any officer or employee with permanent tenure, called into military service for other than normal reserve training, shall be paid in full to the date he leaves his City position or job and in addition, shall receive in compensation for unused vacation and sick leave a sum equal to one month's wage or salary.

1.10 CIVIL SERVICE - (See Charter Ordinance No. 29.)

1.11 SUPERVISORS-See Statutes

1.12 OPENING OF POLLS

All polls on general election days shall be opened at 7:00 A.M. and closed at 8:00 P.M.

1.121 ABSENTEE BALLOTS

The City of Kenosha, Wisconsin declares that in lieu of canvassing absentee ballots at polling places pursuant to Section 6.88, Wisconsin Statutes, the Board of Absentee Ballot Canvassers shall canvass all absentee ballots of all elections held in the City.

No later than the closing hour of the polls, the City Clerk/Treasurer shall post at his/her office, and on the City of Kenosha Internet site before the polls open, a statement of the number of absentee ballots that the City Clerk has mailed or transmitted to electors and that have been returned by the closing hour on election day. The City Clerk/Treasurer shall make available to any person upon their request a copy of said statement.

1.13 COMPULSORY RETIREMENT

A. Declaration. The City of Kenosha declares that its nonprotective employees are not exposed to danger or hazard within the meaning of §111.33, Wisconsin Statutes.

B. City Employees--NonProtective Occupations. There shall be no compulsory retirement age for City employees in nonprotective occupations.

C. City Employees-Protective Occupations. Effective December 31, 1985, no City employee engaged in a protective occupation shall continue in City service upon reaching his/her sixtieth (60th) birthday for the reason that age is a bona fide occupational qualification for protective occupations and for the further reason that retirement at said age is mandated by the business necessity of insuring the establishment and maintenance of a work force which is physically capable of performing in jobs designed to insure the public health, safety and welfare. City employees engaged in protective occupations are deemed to be those City employees whose principal duties involve active law enforcement or active fire suppression or prevention, including the Fire and Police Chief, and all administrative officers and supervisory personnel within the City Police and Fire Departments.

However, in no event shall any City employee engaged in a protective occupation continue in City service upon reaching his/her seventieth (70th) birthday should such situation arise by reason of the City postponing mandatory retirement for such employees at age sixty (60) for reason of legal uncertainty as to whether such retirement is a bona fide occupational qualification for employment under the Age Discrimination in Employment Act.

1.14 CITY PARTICIPATION IN JOINT ACTION EMERGENCY GOVERNMENT FOR KENOSHA COUNTY

A. Policy and Purpose. To ensure that the City of Kenosha will be prepared to cope with emergencies resulting from enemy action and with emergencies resulting from manmade and natural disasters, an Emergency Government organization is created to carry out the purposes set out in Chapter 22 of Wisconsin Statutes, 1971.

B. Definitions, as Used in this Ordinance.

1. Emergency Government includes Civil Defense, and means all measures undertaken by or on behalf of the State of Wisconsin and its subdivisions:

- a.** to prepare for and minimize the effects of enemy action and natural or manmade disaster, upon the civilian population;
- b.** to effectuate emergency repairs to, or the emergency restoration of, vital public utilities and facilities destroyed or damaged by such action or disaster.

2. "Civil Defense" means all those activities and measures designed or undertaken:

- a.** to minimize the effects upon the civilian population caused, or which would be caused, by enemy action;
- b.** to deal with the immediate emergency conditions which would be created by such enemy action; and
- c.** to effectuate emergency repairs to, or the emergency restoration of, vital public utilities and facilities destroyed or damaged by such enemy action.

3. "Enemy Action" means hostile action by a foreign power which threatens the security of this State, or portion thereof.

4. "Natural Disaster" means all other extraordinary misfortunes affecting the City, natural or manmade, not included in the term "enemy action".

C. City Emergency Government Committee.

1. How Constituted. The Committee on Public Safety and Welfare shall act as and perform the duties of the City Emergency Government Committee.

2. Duties. The City Emergency Government Committee shall be an advisory and planning group and shall advise and cooperate with the County Emergency Government Director and his Deputy and staff and it shall further advise the City Common Council on all matters pertaining to Civil Defense. It shall meet on the call of the Chairman.

D. Emergency Government Director.

1. Joint Director. The County Emergency Government Director shall hold the office of Emergency Government Director of the City of Kenosha, subject to the conditions and provisions set forth in the Wisconsin Statutes and in this Ordinance. Said Director shall have the duties and responsibilities of a municipal Emergency Government Director as provided for in §66.30 of the Wisconsin Statutes, 1971. Said Director and any staff he or she may have shall be employed by Kenosha County and shall not be deemed to be City employees, for any purpose.

2. City Deputy Emergency Government Director. The City Administrator shall act as and perform the duties of the City Deputy Emergency Government Director, under the administrative direction of the County Emergency Government Director and the City Emergency Government Committee.

E. Sharing of Costs Pursuant to Section IV County Ordinance No. 75-1.

1. Office and Staff. The Kenosha County Board shall provide offices, office furniture, stenographic help and such office supplies as may be necessary to carry out the functions of the County Emergency Government Director.

2. Major Equipment and Services. Costs of equipment and services shall be borne 100 percent by the municipal government requiring such procurement with Federal matching funds procured by the County Emergency Government Director when applicable. Federal matching fund reimbursements shall be returned to the Treasurer of the municipality procuring the equipment or services.

F. Joint Action Meetings. Whenever it is deemed necessary by either the County Emergency Government Committee, or the City Emergency Government Committee, there shall be a joint meeting of the Committees to decide such matters as may arise.

G. Duties of the County Emergency Government Director.

1. County-wide Duties as Provided by County Ordinance No. 75-1. The Director, in his capacity as Director, subject to the control and direction of the County Emergency Government Committee and under the general supervision of the County Board shall:

- a.** develop and promulgate emergency government plans for the County including planning for Joint Action municipalities, consistent with the State plan of emergency government;
- b.** coordinate and assist in the development of non-joint action municipal emergency government plans within the County, and integrate such plans with the County plan;
- c.** direct the County and Joint Action municipality emergency government programs;
- d.** direct county-wide emergency government training programs and exercises;
- e.** advise the State Administrator of Emergency Government of all emergency government planning for the County and render such reports as may be required by the Administrator;
- f.** in case of a state of emergency proclaimed by the Governor, direct the county and Joint Action municipalities in emergency government activities and coordinate non-joint action municipal emergency government activities within the County, subject to the coordinating authority of the State Administrator; and
- g.** perform such other duties relating to emergency government as may be required by the County Board.

2. Municipal Duties. The Kenosha County Emergency Government Director in his capacity as director for the City of Kenosha, shall:

- a. direct the municipal emergency government organization;
- b. develop, promulgate, and integrate into the County plan, emergency government plans for the operating services of the municipality;
- c. direct participation of the municipality in such emergency government training programs and exercises as may be required on the County level or by the State Administrator;
- d. direct the municipal emergency government training programs and exercises;
- e. perform all administrative duties necessary for the rendering of reports and procurements of Federal matching funds for each municipality requesting Federal matching funds;
- f. in case of a state of emergency proclaimed by the Governor, direct the activities of the municipal emergency government organization;
- g. perform such other duties, relating to emergency government, as may be required by the municipal governing body.

H. Utilization of Existing Services and Facilities. In preparing and executing the Emergency Government Program, the services, equipment, supplies and facilities of the existing departments and agencies of the City shall be utilized to the maximum extent practicable; and the officer and personnel of all such departments and agencies are directed to cooperate with and extend such services and facilities to the Emergency Government Director and his Deputy as are required of them.

I. Emergencies.

1. In the event the Governor determines that an emergency exists growing out of natural or man-made disasters, the County Emergency Government Director will activate and direct the emergency government services of the City.

2. Whenever, during the continuance of a state of emergency proclaimed by the Governor of the State of Wisconsin under Chapter 323 of the Wisconsin Statutes, it becomes imprudent, inexpedient or impossible to conduct the affairs of City government at the regular or usual places thereof, the Common Council may meet at any place within or without the City on the call of the Mayor or his successor, and shall proceed to establish and designate by Ordinance, Resolution or other manner, sites and places as the emergency temporary location of government where all, or any part, of the public business may be transacted and conducted during the emergency situation.

J. Penalties. It shall be unlawful for any person willfully to obstruct, hinder or delay any member of the Emergency Government organization in the enforcement of any order, rule, regulation, or plan issued pursuant to the authority contained in this Ordinance. Whoever intentionally fails to comply with the directives of Emergency Government authorities promulgated under this Section during a state of emergency or during any training program or exercises, may be fined not less than \$100.00 nor more than \$200.00, or imprisoned in the County Jail for a period not more than ninety (90) days, or both.

1.145 EMERGENCY POWERS OF THE MAYOR

A. General Powers-City Emergency. In the event of an emergency covered under Section 1.14 of the Code of General Ordinances, the Mayor shall have the following powers:

1. To assemble all Department Heads for the purpose of forming an advisory body to offer advice upon the need for and to supervise emergency services.
2. To contract with other units of government for the use of manpower and equipment.
3. To contract with private industry, leasing services, manpower and equipment.
4. To order all City employees to immediate active duty.
5. To order City Departments to concentrate their manpower and equipment in a given area or areas.

6. To authorize any City owned or leased property to be made available as emergency shelters, food and water service and dispensing areas, hospital, morgues, bases of operations and the like.

7. To order City employees and equipment to be utilized in the transportation of equipment, supplies, food, water, materials, messages and the like from place to place to assist any governmental, Red Cross or like charitable agency operating within the City.

8. To terminate ordinary City services.

9. To terminate the operation of any City licensed business.

10. To order a curfew for the general public or any segment of the general public in all or any portion of the City.

11. To close any street, park or public facility within the City.

12. To close the Harbor or the Airport.

13. To prohibit railroad traffic within all or any portion of the City.

B. Limitations. The above specified powers are limited as follows:

1. The Mayor may only expend monies which are either budgeted for or which are in the City's contingency fund.

2. The Mayor must call a Council meeting as soon as possible to confirm his actions. If the Mayor does not act promptly in this regard, a special meeting of the Common Council may be called by seven (7) Alderpersons pursuant to the procedure provided for in §1.02 C., Ordinances.

C. Emergencies-Non-City. The Mayor may commit City resources to the same extent of Mayoral powers in a City emergency to assist in an emergency in another governmental unit upon the condition that said other unit of government commits itself to repaying the City for the full cost of City provided manpower and equipment so that there shall be no out-of-pocket costs to the City, and upon the condition the unbudgeted funds or monies in the contingency fund may not be utilized for this purpose.

1.15 ANNEXATION ORDINANCES PRELIMINARY REPORTS

A. Report of City Engineer. Within two weeks after the filing of a petition for annexation of territory to the City, the City Engineer shall determine and report to the Council in writing (with a copy thereof to the City Attorney) the following:

1. Whether the petition is signed by a majority of the electors in the territory; if there be no electors, he shall so state.

2. Whether the owners of one-half of the land area in the territory have signed the petition.

3. Whether the owners of one-half of the real property in assessed value within the territory have signed the petition.

B. Report of City Attorney. Within three weeks after the filing of a petition for annexation of territory to the City, the City Attorney shall examine the petition, notices, reports of City Plan Commission, City Engineer, and the State Department of Administration and give his written opinion to the Council as to whether there has been such compliance with the Wisconsin Statutes as to authorize the enactment of an Ordinance annexing the territory.

C. Report of City Engineer. Within three weeks after the filing of a petition for annexation of territory to the City, the City Engineer shall report to Council, in writing, as to the cost and benefits, if any to the City based on reports made to him by the heads of departments who are in a position to estimate such costs

and benefits.

1.155 DEFERRED ASSESSMENTS PAYABLE UPON ANNEXATION

Upon annexation, all deferred special assessments for sanitary sewer and water mains and laterals and for street and sidewalk grading, graveling and paving shall become due, owing and payable in the same manner and to the same extent as if those assessments were validly assessed against said property on the effective date of annexation, except as heretofore provided. Deferred assessments for sanitary sewer and water mains and laterals shall be due, owing and payable at the charge or per foot assessment rate prevailing on the effective date of annexation. Deferred assessments for street and sidewalk grading, graveling and paving shall be due, owing and payable at the charge or per foot assessment rate prevailing at the time the deferred assessment was passed and became effective.

All deferred assessments shall be payable in installments where installment payments, authorized by City Ordinances, would have been available to any owner of property within the City for such improvements on the effective date of said Annexation Ordinance, although the annexing property owner(s) may, at their option, elect to pay the total amount due, owing and payable forthwith.

Where special assessments are paid on an installment basis, the carrying charges and interest rate in effect upon the effective date of annexation shall apply irrespective of whether or not that date controls in determining the appropriate charge or per foot assessment rate.

Petitions for annexation shall contain a provision that in consideration for City approval of the petition for annexation, petitioners agree to the terms of this Ordinance and waive any rights, if any, which they may have to contest the amounts due, owing and payable or the manner of payment heretofore enumerated, except for potential mathematical errors in calculations. However, the failure of any property owner to agree as above set forth shall not in and of itself void the obligations specified in this Ordinance.

1.17 SEVERABILITY

Every City Resolution, Ordinance, section, subsection or portion thereof, shall be deemed severable in the event that the validity or constitutionality thereof is successfully challenged in Court.

1.18 LICENSES-PUBLIC NUISANCE

The performing of any activity for which a City license is required without first possessing a valid City license therefor shall be deemed to be a public nuisance and the Chief of Police, or designee thereof, shall have the authority, wherein an activity is being performed requiring a City license and where no valid City license is first possessed therefor, to post the entrances to said premises as "closed by order of the Police Department" and, if after such posting, an activity is still being performed requiring a City license in the absence of a valid City license therefor, the premises may be padlocked, boarded up, or otherwise permanently secured by the Police Department through use of police personnel, other City personnel or by private contract. The City Attorney is authorized to seek preliminary or permanent injunctive relief against such public nuisance where posting and securing the premises was not possible or was ineffectual to abate said public nuisance.

Any person entering posted or secured premises for the purpose of doing or attempting to do business with one who is operating a business or enterprise without a valid City license shall be unlawfully upon said premises and in violation of this Ordinance and shall be subject to the penalties specified in §11.16(1), Ordinances.

1.19 REFERENCES TO STATE LAW

References in the City Ordinances to State Statutes and Administrative Code provisions shall mean the most recent enactment thereof and any Ordinances making reference to the contrary shall be null and void.

1.20 PRESERVATION AND DESTRUCTION OF CITY RECORDS

The administrative head of each City of Kenosha Department is authorized to develop a policy and procedure for the retention of public records and destruction of obsolete public records pursuant to the authority of Section 19.21(4), Wisconsin Statutes. The policy may include the keeping and preservation of public records of a department through the use of microfilm or other reproductive devices. Any photographic reproduction of a record authorized to be reproduced under this Section is deemed an original record for all purposes if it meets the applicable standards established in Section 16.61(7), Wisconsin Statutes.

1.21 DISPOSAL OF ABANDONED AND UNCLAIMED PROPERTY

A. The City of Kenosha may, pursuant to the authority of §66.0139, Wisconsin Statutes, and as herein provided for, dispose of any personal property which has been abandoned or which remains unclaimed for a period of thirty (30) days after acquisition. The City shall maintain an inventory of abandoned and unclaimed property, and keep a record of the date and method of disposal, including the consideration received for the property, if any, and record the name and address of the person taking possession of the property. The above information shall be kept as a public record for a period of not less than two (2) years from the date of disposal of said property, as authorized by §B. hereof.

B. Unclaimed and abandoned property, not timely claimed, may be disposed of as follows:

1. The property may be sold at public auction.
2. The property may be sold without a public auction at a sale open to the public.
3. The property may be used in trade on other property to be acquired.
4. The property may be retained by the City for its own use.
5. The property may be donated to a not-for-profit corporation.
6. Motor vehicles will be disposed of in accordance with State law, subject to the property owner being responsible for paying towing and storage charges as a condition of reclaiming the vehicle.
7. Property of nominal value may be destroyed.
8. Shopping carts may be destroyed. If shopping carts are timely claimed by their owner, the owner shall be responsible for reimbursing the City for pickup, (a Twenty (\$20.00) Dollar fee) and storage (a fee of Three (\$3.00) Dollars per day).

C. Whenever property is sold, the proceeds of said sale shall be deposited into the City's General Fund, less the costs of storing and selling said property.

1.22 LICENSE/PERMIT APPLICATIONS

A. Prohibition. It shall be unlawful for any person, acting as an individual, a partner, a corporate officer, or an agent to execute or file with any City Department, or to authorize any person to do so on their behalf, a license or permit application which is not true, correct and/or complete in all material respects and which was known by said person to be untrue, incorrect and/or incomplete. The term "in all material respects" shall mean with respect to some fact, which, if known to the granting authority, would be a basis or a consideration for license or permit denial.

B. Penalty.

1. Any person violating §A. above, shall upon conviction thereof, be subject to a forfeiture not to exceed Five Hundred (\$500) Dollars, plus the payment of the costs of prosecution, and, in default of the timely payment thereof, shall be committed to the County Jail until such forfeiture has been paid, but not to exceed a period of thirty (30) days.

2. The license or permit granting authority may grant but withhold the issuance of, any license or permit for a period not to exceed thirty (30) days from the date of granting under circumstances wherein an application is found by the granting authority to have violated §A. above, and the applicant was provided with an opportunity to appear before the granting authority. The granting authority may also issue a written warning to the applicant which shall be made part of their license/permit record for two (2) consecutive

license/permit years.

Where such finding and penalty is made and imposed by other than the Common Council, applicant may, within ten (10) days of receipt of oral or written notice of the imposition of any such penalty whichever is first if both oral and written notice is provided, file a Notice of Appeal with the City Clerk and have such matter reviewed by the Common Council.

1.225 ADMINISTRATIVE CHARGE FOR PROCESSING LICENSE/PERMIT APPLICATIONS

The first Twenty-five (\$25) Dollars of the application fee for any License Permit shall be retained by the City in the event of a License/Permit denial or the withdrawal of the application by applicant for administrative and processing costs and the balance, if any, refunded to the applicant. Where the application fee is less than Twenty-five (\$25) Dollars the entire application fee shall be retained by the City for administrative and processing costs.

1.23 SCHOOL CROSSING GUARDS

The Police Chief shall appoint adult School Crossing Guards for the protection of persons who are crossing a street, highway or public thoroughfare in the vicinity of a School. The School Crossing Guards shall wear insignia or uniforms which designate them as School Crossing Guards and shall be equipped with signals or signs to direct traffic to stop at School Crossings. School Crossing Guards shall be located at locations designated by the Common Council. The Police Chief, in emergency situations, may transfer the location of School Crossing Guards or add new locations at which School Crossing Guards will be stationed, where appropriate funds are budgeted therefor.

1.24 VOLUNTEERS

A. Definition. VOLUNTEERS, for purposes of this Ordinance, shall mean persons who perform a service for, with the knowledge and consent of, and at the direction of, the City of Kenosha, its Library, Museum and Water Utility, without the benefit of salary or wages, under circumstances wherein they are carrying out the duties of their employment and acting within the scope of their employment.

B. Worker's Compensation. VOLUNTEERS are deemed employees of the City of Kenosha, and its Library, Museum and Water Utility for purposes of Chapter 102 of the Wisconsin Statutes, "Worker's Compensation".

C. Protection From Liability. VOLUNTEERS are deemed employees of the City of Kenosha, and its Library, Museum and Water Utility for purposes of §893.80, Wisconsin Statutes, "Claims against governmental bodies or officers, agents or employees; notice of injury; limitation of damages and suits."; §62.25, Wisconsin Statutes, "Claims and actions."; §62.115, Wisconsin Statutes, "Defense of officers by City Attorney.", and related Wisconsin Statutes and City Ordinances.

1.25 VANDALISM CONTROL REWARDS

The Chief of Police, or his designee, shall have the discretion and authority to pay to any person supplying information to the City which leads to the arrest and conviction of any person who destroyed or damaged any City property, an award of between Fifty (\$50) Dollars and Five Hundred (\$500) Dollars.

1.26 EMPLOYEE INVOLVEMENT IN CITY GOVERNMENT/POLICY & PROCEDURE

A. Purpose. The purpose of this Ordinance is:

1. to promote employee involvement in City government; and,
2. to fully utilize the many combined years of experience of City employees; and,
3. to promote a creative work environment; and,
4. to increase the efficiency and productivity of the City work force; and,
5. to explore cost containment on both a department wide and on a City wide basis; and,
6. to explore cost containment in both large and small matters; and,

7. to provide cost effective service to the public; and,
8. to recognize the thought and effort of City employees.

B. Policy. It is the declared policy of the City of Kenosha to encourage both management and nonmanagement employees to take an active interest in the affairs of City government with respect to matters both within and without their respective departments and to submit creative suggestions and constructive criticism with respect to the scope and efficiency of City services.

C. Definitions. The term "employee(s)", as used herein, shall include management and nonmanagement employees, full and part-time employees, City officers, members of any City Committee, Board, Commission or Authority, and employees and officers of the City Water Utility, Library and Museum.

D. Exclusion. Excluded from consideration herein is any matter relating to employee salaries, wages and fringe benefits, which matters shall be deemed under the exclusive jurisdiction of the Common Council and its Committee on Finance.

E. Employee Involvement Committee. This Ordinance shall be administered by the "Employee Involvement Committee", composed of three (3) Aldermen, appointed by the Mayor and confirmed by the Common Council. The Mayor shall appoint members to said Committee forthwith, upon passage and publication of this Ordinance, and thereafter on or before the first Monday of May of each even numbered year. A Chairman and Acting Chairman shall be elected by such Committee, annually, on or before the third Monday of May of each year.

F. Confidentiality. Employees may declare their creative suggestions and constructive criticisms to be confidential and when this is done, their names shall not be publicly associated therewith.

G. Procedure.

1. Form Of Proposals. Proposals shall be dated in written, legible form, and submitted under the signature of the employee. The employee's name and Department shall be printed thereon.

2. Submission Of Proposals. City employees, Department Heads, officers and members of City Committees, Boards, Commissions and Authorities shall submit their proposals to the City Administrator who shall forward a copy to the Employment Involvement Committee.

3. Review Of Proposals. The City Administrator, upon the receipt of a proposal, shall submit it to interested or affected Departments, Committees, Boards, Commissions or Authorities for their review and comment and then shall conduct his/her own investigation and analysis.

4. Recommendations On Proposals.

a. The City Administrator, following receipt and review, shall submit proposals with his/her recommendations, to the Employee Involvement Committee for review and recommendation.

b. The Employee Involvement Committee shall submit its recommendations to the Mayor and Common Council for final action.

5. Annual Report. The Employee Involvement Committee shall file an Annual Report with the Common Council listing proposals received and actions taken.

H. Employee Rights. Employees who make proposals hereunder shall not be discriminated against or prejudiced for said action by any person acting in a superior employment capacity. Any employee who has reason to believe that they are the subject of such discriminatory or prejudicial action, may file a request for a hearing on said issue before the Employee Involvement Committee who may, where appropriate, direct responsible persons to take corrective action.

1.27 POLL WORKERS

A. Definitions.

"Election official" or "official" means an individual who is charged with any duties relating to the conduct of an election. The terms include chief inspectors, inspectors, tabulators, greeters, and special registration deputies.

B. Pursuant to Section 7.30 of the Wisconsin Statutes, the City Clerk/Treasurer is authorized to select alternate officials, as that term is used by the statutes, in a number sufficient to maintain adequate staffing of polling places. The City Clerk/Treasurer may select two or more sets of officials to work at different times on election day and may establish different working hours for different officials assigned to the same polling place. Except for inspectors who are appointed under paragraph 7.30(1)(b) of the Wisconsin Statutes and officials who are appointed without regard to party affiliation under paragraph 7.30(4)(c), additional officials shall be appointed in such a manner that the total number of officials is an odd number and the predominant party under Subsection 7.30(2) is represented by one more official than the other party. The City Clerk/Treasurer may appoint one additional inspector to serve at each polling place without regard to party affiliation who shall serve as a greeter to answer questions and to direct electors to the proper locations for registration and voting and who shall be available to substitute for other election officials who must leave the room during the voting process.

C. Election Officials shall not serve in such capacity at the polls in any ward of any aldermanic district under circumstances in which they are related by blood or marriage to the candidate for the office of Alderman for said district in the following capacity: Father (Step-Father); Mother (Step-Mother); Brother (Step-Brother); Sister (Step-Sister); Son (Step-Son); Daughter (Step-Daughter); Grandfather; Grandmother; Aunt; Uncle; Husband; or Wife.

1.28 RESIDENCY REQUIREMENT

A. Residency Requirements. Residency is required as follows for City officers and employees:

1. For the Mayor, Alderman and Municipal Court Judge, as required by §62.09(2)(a), Wisconsin Statutes.

2. For Board and Commission members, as provided for in §1.056 of the Code of General Ordinances, unless expressly provided to the contrary in enabling legislation creating a specific Board or Commission.

3. For represented and nonrepresented, nonprotective service employees, pursuant to the Civil Service Ordinance Rules and Regulations.

4. For represented protective service employees, pursuant to the terms of their respective collective bargaining agreement.

5. For nonrepresented protective service employees as follows: Nonrepresented protective service appointees of the City of Kenosha who are residents of Kenosha County shall remain residents thereof during their incumbency in City employment. Nonrepresented protective service appointees who are not residents of Kenosha County at the time of appointment shall move within the County within three (3) months following satisfactory completion of the probationary period and shall thereupon remain residents thereof during their incumbency. For specific and substantial cause, the Public Safety & Welfare Committee, upon receiving the recommendation of the Personnel Director, may grant an extension of the time limit to move into Kenosha County.

B. Definitions. For purposes of the above, the following terms shall have the meaning below provided:

1. **"Represented Employee"** shall mean any employee who is bound by the terms of any collective bargaining agreement to which the City is a party.

2. **"Non-Represented Employee"** shall mean any employee who is not bound by the terms of any collective bargaining agreement to which the City is a party.

3. **"Protective Service Employee"** shall mean any employee of the City covered under Section

40.02 (48) "Protective Occupation Participant", Wisconsin Statutes.

4. **"City"** shall mean the City of Kenosha and its Water Utility and Museum.

5. **"Board and Commission"** shall mean any City subunit referred to as a Board or Commission and shall also include any subunit designated as an Authority. It shall not include Special Committees created by the Mayor or Common Council by Resolution, which are temporary in nature.

1.29 HARASSMENT POLICY & PROCEDURE

A. Policy. It is the policy of the City of Kenosha that Employees shall not, directly or indirectly, engage in any form of Harassment, whether it occurs in the workplace or outside the workplace at City-sponsored activities.

The City of Kenosha is committed to providing and maintaining a professional work environment that maintains Employee equality, dignity, and respect. It is the policy of the City of Kenosha that Harassment, including Sexual Harassment, and/or retaliation is strictly prohibited. Harassment of any kind increases hostility, creates an offensive working environment, adversely affects productive working relationships, and ultimately obstructs the City's vision of a diverse workforce, reflective of the City itself. Employees are entitled to a work atmosphere free from Harassment based upon race, color, creed, sex, religion, age, disability, pregnancy, sexual orientation, national origin, ancestry, marital status, military or veteran status, citizenship, arrest record, conviction record or any other characteristic protected by State, Federal or local law.

Behavior that creates a hostile work environment is a serious offense and will not be tolerated. All Employees are prohibited from participating in any conduct that could be construed as Harassment, as defined by this Ordinance. Any individual who is determined to have engaged in acts of Harassment will be disciplined appropriately, up to and including dismissal.

Whether one is a victim of Harassment or simply a witness to it, all Employees are required to report any incidents of Harassment. All complaints of Harassment are to be made in accordance with the reporting procedures set forth in this policy. This prohibition against Harassment is to be enforced by all supervisory and administrative Employees. Accordingly, disciplinary action will also be taken against any supervisor or administrator who knowingly allows such conduct to occur without taking appropriate action.

B. Definitions.

1. **"City of Kenosha"** means the City of Kenosha and its Water Utility, Redevelopment Authority, Housing Authority, Library, Museum, and any Board, Commission, Authority, Committee or Department created by Ordinance or Resolution.

2. **"Employee"** shall mean an individual employed by or performing services for the City of Kenosha. "Employee" includes employees and officers of the City of Kenosha and members of the Common Council and of any Board, Commission, Authority, Committee or Department created by Ordinance or Resolution.

3. **"Enforcing Officer"** shall mean the Director of Personnel or his/her designee.

4. **"Harassment"** shall mean any verbal, written, visual or physical act based upon race, color, creed, sex, religion, age, disability, pregnancy, sexual orientation, national origin, ancestry, marital status, military or veteran status, citizenship, arrest record, conviction record or any other characteristic protected by State, Federal or local law, that affects terms or conditions of employment, interferes unreasonably with an individual's work performance, or creates a hostile working environment. Harassment shall also mean retaliation against any Employee for filing of a Harassment complaint or cooperating with the investigation of a Harassment complaint. Harassment shall also mean the knowing and malicious filing of a complaint under this Ordinance for the sole purpose of affecting the terms and/or conditions of employment of a City Employee or subjecting a City Employee to a hostile work environment.

While it is not possible to list all those circumstances that may constitute unlawful Harassment, the following are some examples of conduct that, if unwelcome, may constitute Harassment depending upon

the totality of the circumstances, including severity of the conduct and its pervasiveness.

- Epithets, slurs, insults or negative stereotyping with regard to race, color, creed, sex, religion, age, disability, pregnancy, sexual orientation, national origin, ancestry, marital status, military or veteran status, citizenship, arrest record, conviction record or any other characteristic protected by State, Federal or local law.
- Acts or jokes that are hostile or demeaning.

5. "Sexual Harassment" shall mean any unwelcome sexual advance, request for sexual favors, or other verbal or physical conduct of a sexual nature that creates a hostile work environment, regardless of the gender of the harassing party, or is used as the basis for employment decisions affecting the Employee.

The types of behaviors that constitute Sexual Harassment may include, but are not limited to:

- Physical assault;
- Unwelcome sexual flirtations, advances or propositions;
- Derogatory, vulgar, or graphic written or oral statements regarding one's sexuality, gender or sexual experience;
- Unnecessary touching, patting, pinching or attention to an Employee's body;
- Entering the restroom of the opposite sex for purposes unrelated to employment or when occupied by individuals of the sex for whom the restroom is designated;
- Unwanted sexual compliments, innuendoes, suggestions or jokes;
- Asking Employees about their sexual experiences or discussing one's own sexual experiences;
- Displaying pictures, posters, cartoons, calendars, graffiti, objects, promotional materials, reading materials, music, or other materials that are sexually suggestive or sexually demeaning.
- Displaying or publicizing in the work environment, materials that are in any way sexually revealing, sexually suggestive, or sexually demeaning;
- Displaying signs or other materials purporting to segregate an Employee by gender in any area of the workplace other than restrooms and similar semi-private lockers/changing rooms;
- Birthday, promotional, or farewell parties, or other celebrations that feature cards, cakes or food items or performances of a sexual nature;
- Production, transmission or display of any sexually explicit material electronically via fax, e-mail, the Internet, or any other similar mode of workplace communication;
- Any of the above that may be deemed harassing on any other unlawful basis are likewise prohibited.

C. Prohibition of the Possession or Display of Harassing Materials. Employees are prohibited from possessing, displaying, disseminating, distributing, trading or sharing of any materials, regardless of format; (e.g., electronic, paper, film, video, animated) that constitute Harassment on the basis of race, color, creed, sex, religion, age, disability, pregnancy, sexual orientation, national origin, ancestry, marital status, military or veteran status, citizenship, arrest record, conviction record or any other characteristic protected by State, Federal or local law. This prohibition extends to all materials which are pornographic and/or demeaning. This includes, but is not limited to, nude, semi-nude or scantily clad images, or images of non-nude people intended to simulate acts or exhibit expressions which are intimate, sexual, demeaning or provocative.

This prohibition extends to all City of Kenosha property and outside the workplace at City-sponsored activities.

D. Application of This Policy. This Ordinance applies to all Employees of the City of Kenosha. There will be no variance or exception to this Ordinance, except as explicitly provided by this Ordinance.

E. Complaint Procedure. The following steps should be followed in reporting Harassment:

1. Harassment To Be Reported. Employees who believe they have been or currently are being the subject of Harassment, have the responsibility to report the Harassment. Employees who witness Harassment have the responsibility to report the Harassment even if they are not the subject of the Harassment.

2. Complaint Forms And Filing. Any Employee who believes he/she has been the subject of Harassment, or any Employee who is aware of Harassment directed towards another Employee, should immediately report that behavior, either orally or in writing, through the appropriate reporting procedure. A City Department may specify a reporting procedure in writing, subject to the approval of both the City Attorney, or his/her designee, and the Director of Personnel, or his/her designee. If the Department has not specified a reporting procedure, the Employee should direct his/her complaint to his/her immediate supervisor, any other supervisor, or his/her Department Head. All complaints, oral or written, shall be brought to the attention of the Department Head and the Director of Personnel.

Once a complaint has been made, the City of Kenosha will take steps to ensure the complainant is not subject to additional Harassment during the processing of the complaint. Reported complaints shall be reduced to writing by either the complainant or a member of the Human Resources Department, on forms available in the Human Resources Department. A separate complaint shall be filed for each alleged harasser. Complaints shall be signed. However, failure of a complainant to sign the complaint form will not prevent full investigation and processing of the complaint. Should any person in the Human Resources Department be the subject of an Harassment complaint, complaint forms may be obtained and filed in the City Attorney's Office.

The complainant shall have the option of conciliation through the City Administration prior to the complaint being submitted to the Enforcing Officer. Upon the refusal of such option, the complaint will be referred by the office in which filed to the Enforcing Officer.

The Enforcing Officer, within ten (10) working days of the receipt of the complaint, shall notify the Employee accused of Harassment that a complaint has been filed against him/her, and request that a written response be provided within twenty (20) days. The Employee accused of Harassment shall be notified of the confidentiality requirements of this Ordinance and the prohibition against retaliation.

If the Enforcing Officer determines that the complaint, on its face, even if true, does not allege facts sufficient to constitute a violation of this Ordinance, he/she shall dismiss the complaint and notify the complainant and the Employee accused of Harassment. If the Enforcing Officer determines that the complaint, on its face, alleges facts, which, if true, may be sufficient to constitute a violation of this Ordinance, he/she shall make an investigation with respect thereto. If the complaint involves rape, assault or other conduct of a criminal nature, the Kenosha Police Department shall be contacted, and a report of the incident shall be made.

Pursuant to any investigation conducted under this Ordinance, the Enforcing Officer has the power to require any Employee to submit, in writing, such reports and answers to questions relevant to the investigation as the Enforcing Officer may prescribe, such submission to be made within such period and under oath, or as he/she may otherwise determine.

Investigation of any Employee accused of Harassment may not be commenced until the Employee, who is the subject of the investigation, has been notified of the complaint and given an opportunity to respond as herein provided.

3. Protection Against Retaliation. The City of Kenosha will not permit or condone retaliation against an Employee who files a Harassment complaint, makes a report of Harassment, or participates in an investigation of Harassment. Retaliation is a violation of this Ordinance and shall be reported immediately. Any Employee found to have retaliated against another Employee for filing a Harassment complaint, reporting Harassment, or participating in an investigation of Harassment will be subject to the same disciplinary action as provided for Harassment offenders. Complaints for retaliation shall be reported and processed in the same manner as complaints for Harassment.

F. Investigating The Complaint.

1. Confidentiality. Any Harassment complaint filed under this Ordinance will be promptly investigated in a confidential manner so as to protect the privacy of persons involved. Confidentiality will be maintained throughout the investigatory process, and records will be released only if required by State or Federal law.

Members of the Common Council and Committees thereof shall not have access to confidential information. Collective bargaining units and members thereof shall have and retain any rights of representation authorized under a Collective Bargaining Agreement.

2. Investigation. Harassment complaints will be investigated by the Enforcing Officer or his/her designee.

3. Investigation Process. In pursuing the investigation, the Enforcing Officer will try to take the wishes of the complainant under consideration, but shall thoroughly investigate the matter as he/she sees fit, keeping the complainant and Employee accused of Harassment informed as to the status of the investigation. If the complainant indicates that he/she does not agree with the action taken, the Enforcing Officer may request that the complainant provide suggestions in writing for possible consideration. Although suggestions submitted will be given full consideration, the City of Kenosha reserves the right to determine the final action taken based on the totality of findings from the investigation.

G. Resolving The Complaint. Upon completing the investigation of a Harassment complaint, the Enforcing Officer will communicate his/her/their findings to the City Administrator, or Mayor if the City Administrator is the Employee accused of Harassment, the Personnel Director, the Department Head of the complainant, and to the complainant and the Employee accused of Harassment.

If the Enforcing Officer finds that Harassment has occurred, the Employee accused of Harassment will be subject to appropriate disciplinary procedures, as hereinafter set forth, in accordance with applicable procedures. The complainant will be informed of the disciplinary action taken.

If the Enforcing Officer determines that no Harassment has occurred, this finding will be communicated to the complainant in an appropriately sensitive manner.

The Enforcing Officer may, with the consent of the complainant and Employee accused of Harassment, attempt to resolve the complaint by conciliation. However, any proposed resolution of the complaint shall only have the force and effect of a recommendation to any Department Head, or to any person or body having appropriate jurisdiction to impose discipline upon the Employee who is deemed to have violated this Ordinance.

The Enforcing Officer, upon making a finding of a violation of this Ordinance, may, but is not obligated to, make a recommendation with respect to the nature of the discipline to be imposed.

An Employee found to have engaged in misconduct constituting Harassment will be disciplined, up to and including discharge. Appropriate sanctions will be determined by the Department Head, or by the person or body having appropriate jurisdiction in accordance with applicable procedures. Records of substantiated charges of Harassment will be placed in the accused Employee's file. Additional action may include referral to counseling, withholding of a promotion, reassignment, suspension without pay, withholding of salary increases, or termination, when and as authorized by applicable law, rule, or regulation.

H. Maintaining A Written Record Of The Complaint. The City of Kenosha shall maintain a complete written record of each complaint and how it was investigated and resolved. Written records shall be maintained in a confidential manner in the Human Resources Department, except where disclosure is required under the Public Records Law.

Written records will be maintained for the longer of seven (7) years from the date of the resolution of the complaint, or so long as the complainant or Employee accused of Harassment is employed by the City of Kenosha.

I. Severability and Conflict of Laws. In the event that this Ordinance may conflict with Federal or State law, it will be interpreted to comply with such. The subsequent invalidity or unenforceability of any one or more of the provisions or clauses hereof shall not effect the validity or enforceability of the other provisions or clauses hereof.

1.295 CONFIDENTIALITY AND IMPARTIALITY

A. Definitions.

1. Covered Official means any individual holding an elective City office and any individual holding an elective City office serving as a member of a City Board, Committee, Commission or Authority, who is not otherwise covered under Chapter 30 of the Code of General Ordinances. Covered Official does not include any individual holding the office of municipal judge who is governed by State law.

2. Confidential Information means documents that are protected from disclosure under Wisconsin's Public Records Law as well as documents and conversations which are the subject of a closed session under the Wisconsin's Open Meetings Law. Confidentiality shall cease with respect to the following, as hereinafter specified:

a. Contracts & Leases - When a final agreement is approved and executed by the parties.

b. Litigation - When a final order or judgment has been entered by a court or administrative tribunal, and all appeals times have expired with regard to the final order or judgment, excepting matters of attorney/client privilege.

c. Claims Settlement Where No Litigation Exists - When a final release has been executed and received, excepting matters of attorney/client privilege.

d. Deeds and Easements - When a deed or easement is received and accepted.

e. Labor Negotiations - When a labor agreement is approved and executed.

Notwithstanding the above, the Mayor, City Administrator or Department Head responsible for any of the above may waive confidentiality, where a waiver will not damage the interest sought to be protected. However, in no event will the strategy used to achieve a given result be made public, nor will preliminary drafts of documents or agreements, unless required to document or support the City's position in a court of law or before any administrative agency.

3. Disclose, with respect to Confidential Information, means to provide, show or relate documents or conversations to a person who is not privy to Confidential Information or whose input is not essential or beneficial to the processing of a transaction.

4. Quasi-Judicial Capacity means to act in the capacity of an administrative hearing examiner, with respect to the following:

a. Employee disciplinary hearings before the Civil Service Commission, Board of Police and Fire Commissioners, or any other Board, Committee, Commission or Authority.

b. License or Permit suspension, revocation and nonrenewal hearings before the hearing body designated by ordinance or state statute.

Quasi-Judicial Capacity shall not include the process of determining whether or not charges are to be filed or action taken, nor shall it include any legislative acts.

The quasi-judicial process commences, for purposes hereunder, at the time a formal written complaint or appeal is served and filed and shall terminate upon a final decision being made and filed by the hearing body.

B. Construction

This Section shall be construed so as to acknowledge that it is subordinate to Federal and State laws, rules and regulations governing specific Covered Official conduct, and also so as to acknowledge that it is subordinate to Federal and State constitutional rights of a Covered Official.

C. Standards

1. Confidential Information.

a. No Covered Official may disclose any information gained during the course of their service in a confidential capacity to any person, where not expressly or impliedly authorized to do so, unless and until such information is or becomes a public record.

b. No Covered Official may use any information gained during the course of their service in a confidential capacity for their own personal financial gain unless and until such information is or becomes a public record.

The obligation to preserve confidentiality shall continue, following termination of service, for so long as the City's need for confidentiality exists, unless and until such information is or becomes a public record.

2. Quasi-Judicial Hearings.

a. No Covered Official, while acting in a Quasi-Judicial Capacity, may have ex-parte communications, oral or written, initiated or received, with any person having an interest in the matter, outside of the scope of the formal hearing process, when said communication bears on the merits of any issue which is pending before their respective hearing body. Procedural issues are not deemed issues which bear on the merits. A matter shall not be deemed pending until a complaint has been filed. A Covered Official acts in a Quasi-Judicial Capacity when serving on a body which is engaged in conducting a due process hearing.

b. A Covered Official who inadvertently violates the above subsection, shall forthwith notify, in writing, their respective body of the act, date of circumstances, and names of persons involved, attaching a copy of any written communications thereto. A copy of such notice shall also be served upon the parties, or their respective attorneys, which are a party directly involved in the hearing process.

c. No Covered Official may influence or attempt to influence any person who is engaged in conducting a quasi-judicial hearing outside of the hearing process, with respect to the merits of any issue.

D. Penalties

Except as hereinafter provided, anyone violating any of the provisions of this Section, upon conviction thereof, shall be subject to a forfeiture not to exceed One Thousand (\$1,000.00) Dollars, plus the payment of the costs of prosecution, assessments and surcharges, and in default of the timely payment thereof, shall either be committed to the County Jail for a period not to exceed ninety (90) days, or the Court may suspend the Defendant's motor vehicle operating privileges until the forfeiture, assessment, surcharges and costs are paid, except that the suspension period may not exceed one (1) year.

1.30 INTERNET USAGE AND ELECTRONIC MAIL (E-MAIL) POLICY

A. Definitions.

1. Electronic Mail/E-Mail shall mean and include:

- a. Communications sent to or received from any person, whether or not a City employee, through a City computer.
- b. Information sent or received via the Internet.

1. "City" shall mean and include the City of Kenosha, its subunits and its Boards, Commissions, Authorities and Committees, except the Kenosha Public Library.

2. "Employee" shall mean an employee or officer of the City or any volunteer performing services for the City. **"Employee"** shall also mean the officer or employee of any City contractor or service provider, except when confined to the contractor's or service provider's own Internet service and E-mail provider and accessed through their own computer systems.

3. "Internet" means collectively the myriad of computer and telecommunications facilities, including equipment and operating software, that comprise the interconnected worldwide network that employ

transmission control protocol or Internet protocol, or any predecessor or successor protocols or technologies, to communicate information of all kinds by wire or wireless transmission.

4. "Internet Usage" means using the World Wide Web or other Internet program through a City computer.

5. "Management" means the executive or administrative head or director of the City or any subunit and the President or chairperson of any Board, Commission, Authority or Committee, and designees thereof.

B. Purpose. The purpose of this Ordinance is to:

1. Protect the confidentiality of authorized employee business communications.
2. Protect City proprietary information.
3. Maintain efficiency in the workplace.
4. Control and reduce unnecessary entries on City computers which impact on processing.
5. Protect the image, interests, and integrity of the City's business communications, whether internal or external.
6. Protect against copyright infringement.
7. Protect against harassment and/or the creation of a hostile work environment.
8. Address privacy issues.

C. Policy. The Internet Usage and E-Mail Policy of City shall be as follows:

1. The purpose of Internet usage and E-Mail is to conduct City business.
2. City computers are City property.
3. Internet usage and E-Mail may not be used for personal gain, profit or non-City business.
4. Copyrighted material will be treated in accordance with applicable law.
5. Management has the right to monitor Internet usage and E-Mail messages, including the right to read, retrieve, and disclose all Internet usage and E-Mail messages for any lawful purpose.
6. City employees, except as provided in Subsection C.5., do not have the right to monitor, read, retrieve and disclose other City employees' E-Mail messages without their consent.
7. Files may only be downloaded from the Internet as permitted by written policy promulgated by, or written consent from the City Administrator or designee.
8. Violations of this policy may result in disciplinary action.

D. Prohibition. Internet usage and E-Mail is not to be used:

1. In a manner that is disruptive of City operations, that adversely affects the City's public image, interests, integrity, that is harmful to employee morale, or in a manner as may create a hostile work environment.
2. For the display or transmission of pornographic or sexually explicit images, messages or cartoons.
3. For the display or transmission of ethnic slurs, racial epithets, or any message that is harassing or disparaging of others based upon their race, national origin, sex, sexual orientation, age, disability or religious or political beliefs.
4. To solicit or proselytize others for commercial ventures, religious or political causes, or outside organizations.
5. To pursue or further any unlawful activity.
6. In a manner that will defame any person.
7. Contrary to Section 947.0125, Wisconsin Statutes.

E. Exception to Prohibition. Subsections D.2. and 3. do not apply to employees who are required to perform such tasks by their employer for any lawful purpose.

F. Library Patrons. Patrons and employees of the Library will be governed by policy created by the Library Board.

1.31 PUBLIC ART DONATIONS - GUIDELINES AND PROCEDURES

A. Purpose. The purpose of this Ordinance is to establish guidelines for Artists and Donors to submit Public Art Proposals to the City and for the City to review the Proposal and provide for Donation Agreements where the Proposal is accepted.

B. Definitions. For purposes of this Ordinance, the following terms shall have the meanings provided.

1. **"Artist"** shall mean an artist, sculptor, architect, craftsperson or landscaper who designs, creates and installs Art.

2. **"City"** shall mean the City of Kenosha, Wisconsin, and its subunits.

3. **"City Staff"** shall mean the Director of City Development, Director of Parks, Library Director, Museum Director (or their designees), and the City Engineer.

4. **"City Staff Recommendation"** shall mean a joint recommendation of City Staff concurred in by at least three (3) representatives.

5. **"Donor"** shall mean a person or party who desires to donate a Public Art Project.

6. **"Public Art"** shall mean permanent, tangible and publicly viewable statuary, murals, memorials, mosaics, monuments, and permanent exhibits for outdoor display which are commissioned or created for display on Public Property. It does not include public buildings, operating equipment, public infrastructure, interior furnishings and decorations, or temporary art forms, exhibits and displays.

7. **"Public Art Proposal" or "Proposal"** shall mean a proposal by an Artist to donate Public Art or a Proposal by a Donor to donate Public Art.

8. **"Public Property"** shall mean property owned or controlled by the City.

C. Review Guidelines. The Common Council will review Public Art Proposals and accept only those Proposals which are in the best interest of the City, and meet the goals and criteria and the other requirements of this Ordinance.

D. Public Art Goals. Public Art shall serve the following goals:

1. Enhance Public Property without compromising its public use and inherent beauty.

2. Create a distinctive, harmonious image.

3. Create an impression that is visually compatible and complementary to the surrounding area.

4. Relate to the context, landscape, architecture and overall aesthetics for the area for which it is proposed.

5. Have color schemes and materials appropriate for the context of the Public Art and for the context of the surrounding area.

E. Financial Criteria.

1. **Artist and Donor Considerations.** The City is a tax exempt entity. Artists and Donors are entitled to Federal and State tax deductions to the extent permitted by law. The City, in accepting Public Art does not guarantee a tax deduction or assume any liability for taxes arising out of a donation of Public Art or funds for Public Art.

2. **City Considerations.** The City, in reviewing a Public Art Proposal, may consider whether the Proposal is financially advantageous to the City. The donation is considered financially advantageous to the City where there is no cost or expense to the City in the design, shipping, assembly, site preparation and installation/construction of Public Art.

F. Effect of Accepted Proposal. The City shall have all rights, title and interest in donated Public Art, including copyright and publicity rights, unless agreed to the contrary in a Donation Agreement.

G. Effect of Rejected Proposal. The City shall have no right, title or interest, copyright or publicity rights in a rejected Public Art Proposal.

H. Artist and/or Donor Credit. The City, in displaying Public Art, shall give credit to the Artist and/or Donor. The Artist shall have the right to reference the Public Art in a biography or reference, which may include pictures and renderings.

I. Site Criteria. A Public Art Proposal shall address and meet the following Site Criteria:

1. Site Plan.

- a. Provide a Site Plan showing the general location and a specific area for the Public Art, where known.
- b. Provide a diagram of any proposed lighting and mechanical components.
- c. Provide details for site preparation, foundation, and utility requirements.

1. City Ordinance Requirements. The Public Art and its location and installation/construction shall conform to City General and Zoning Ordinances.

2. Public Accessibility. Public Art shall be reasonably accessible to the public.

3. Permits. Applicable Zoning, Building and Electrical Permits and approvals shall be obtained as a condition of installation/construction.

4. Durability and Safety. Public Art shall be durable in terms of maintenance and operation, easy to clean, and resistant to vandalism or defacement. Public Art should not pose any significant safety risk to people that may approach it for closer inspection and appreciation.

J. Public Art Proposal Submission. A Public Art Proposal is to be submitted to the Department of City Development. The Public Art Proposal shall contain a Letter of Interest, including the following:

1. Current resume of Artist.
2. Experience of Artist in completing Art Projects, including visual representations showing examples of Art Projects completed or in progress, and its location, materials, size, weight, finish and color, date completed and cost.
3. Concept Design, showing visual representation, location, size, materials, color, estimated completion date and estimated cost.
4. Statement of how Concept Design meets these guidelines.

K. Review and Preliminary Recommendation. The Public Art Proposal, if complete as to form shall be reviewed by City Staff. City Staff may confer with the Artist or Donor and/or require further submittals. City Staff shall make a recommendation as to whether the Proposal meets these guidelines. The City reserves the right to reject any proposal for any reason.

City Staff, following review, will send the Artist/Donor a letter either rejecting the Proposal, requesting revisions within prescribed guidelines or preliminarily accepting the Proposal. A City Staff Recommendation shall authorize the Artist/Donor to proceed with Preliminary Design Plans.

L. Preliminary Design Plans. Upon receipt of a letter from City Staff authorizing the Artist/Donor to proceed with preliminary design plans for the Public Art, the Artist/Donor will submit to City Staff:

1. A sketch and/or model, to scale, along with any other documents or presentation techniques that provide a meaningful representation of the proposed artwork.
2. Written details regarding materials, size, weight, finish and color.
3. Estimated budget.
4. An outline of preliminary maintenance recommendations.
5. A step-by-step process of installation/construction, including site preparation and utilities.
6. Estimated time for final design, shipping and installation/construction.

M. Review of Preliminary Design Plans. City Staff, in reviewing the Preliminary Design Plans, may request or suggest changes to the plans. If changes are not acceptable to the Artist/Donor, then the Artist/Donor may present an alternative or discontinue the Project.

A favorable City Staff Recommendation will result in the Public Art Proposal being submitted to the City Plan Commission for review and recommendation.

N. Final Review and Approval. The Preliminary Plans for the Public Art Proposal will be reviewed and approved by the following bodies (the Approving Body), as applicable:

- For City, the Common Council.
- For Parks, the Board of Park Commissioners.
- For Library, the Library Board.
- For Museum, the Museum Board.
- For Redevelopment Authority, the Authority.
- For Housing Authority, the Authority.
- For Water Utility, the Board of Water Commissioners.

In the event the Public Art Proposal is approved with conditions not acceptable to the Artist/Donor, the Artist/Donor may discontinue the Project.

The Approving Body may approve, approve with conditions, or deny the Public Art Proposal. Any approval, with or without conditions, shall be effective only upon a Donation Agreement drafted or approved by the City Attorney, also being approved by the Approving Body and executed by the parties.

O. Donation Agreement. A Public Art Proposal shall not be deemed accepted until the Artist/Donor has executed a Donation Agreement, drafted or approved by the City Attorney, and approved by the Approving Body, addressing issues which may include, but are not limited to the following:

- Access to site;
- Site preparation and utilities;
- Schedule of critical dates;
- Inspection of work in progress;
- Final acceptance procedure;
- Independent contractor status;
- Documentation and records;
- Warranties;
- Compliance with laws, rules and regulations, and nondiscrimination;
- Copyright and publicity rights;
- Alteration of plans or work;
- Alteration of site;
- Maintenance;
- Repairs;
- Utilities;
- Lighting;
- Relocation or termination of use;
- Indemnity and Hold Harmless Agreement; and,
- Effect of breach of Agreement.

1.32 CITY BACKGROUND INVESTIGATIONS AND POLICE RECORD CHECKS REGARDING EMPLOYEES, APPLICANTS FOR EMPLOYMENT AND PROSPECTIVE APPOINTEES TO ANY OFFICE

The City of Kenosha Police Department, and/or Kenosha City/County Joint Services, are authorized to conduct City background investigations and police record checks regarding any officer, employee, applicant for employment, and prospective appointee to any office, when and as requested by the Director of Human Resources, City Attorney, or designees thereof, and issue a written report with respect thereto. The purpose of the investigation, record check and report is to determine suitability for employment, continued employment or appointment.

CHAPTER II
FINANCE

2.01 FISCAL YEAR

The calendar year shall be the fiscal year.

2.015 LEASE/CONTRACT ADMINISTRATION

A. Definition. Subunit(s) shall mean any Board, Commission or Authority which is created by Ordinance or Resolution duly enacted by the Common Council, irrespective of whether it may act independently of the Common Council.

B. Form. All Leases and Contracts respecting the City and its subunits shall be in writing. Professional services billable at an hourly rate may be the subject of a purchase order which specifies the hourly rate. However, any legal services agreement based upon a contingent fee arrangement must be drafted or approved by the City Attorney.

C. Review. All Leases and Contracts, prior to approval, shall be submitted to the City Attorney for review and recommendation.

D. Amendment. Approving and reviewing bodies shall not approve amendments to any Lease or Contract without first submitting said proposed amendments to the City Attorney for review and recommendation.

E. Administration. The Department of Finance shall be responsible for the administration of Contracts and Leases which are not intended to be fully performed in the calendar year in which executed and entered into by the City, or any subunit under circumstances wherein said Department is responsible for processing related accounts receivable or payable. Excepted from this paragraph are public construction and improvement contracts which shall be administered by the Director of Public Works and the General Manager of the Kenosha Water Utility, as relevant.

F. Procedure.

1. Execution. The initiating Department or subunit is responsible for having Leases and Contracts executed and procuring all required initial bonds and certificates.

2. Original Filed. The original or a duplicate original of every such Lease and Contract shall be filed in the Office of the City Clerk by the initiating Department or subunit, and shall be numbered and indexed both by party and subject matter.

3. Copy Filed. A copy of every Lease and Contract with applicable bonds and certificates, following execution, shall be filed in the Department of Finance as soon as practicable by the initiating Department or subunit.

4. Renewal. The Department of Finance shall notify the Mayor and any relevant Department or subunit ninety (90) days prior to any automatic renewal provision or option to renew of the critical date for extension or termination.

5. Future Bonds And Certificates. The Department of Finance shall be responsible for notifying the initiating Department or subunit of any expired bond or certificate, or new submittals required.

6. Performance Compliance. The initiating Department or subunit shall be responsible for monitoring Lease and Contract performance or default and take appropriate steps to remedy any deficient performance or default.

7. Accounts Receivable. The Department of Finance shall notify the City Attorney of any default in any account receivable which is past due for more than thirty (30) days.

8. Monitoring Chart. Each Lease and Contract shall have affixed to it a monitoring chart, prepared by the initiating Department or subunit which lists all critical dates for action.

2.02 BUDGET

(See §§62.12 and 65.90, Wisconsin Statutes.)

A. Submission. The Mayor shall submit to the Council not later than the third Monday of October, an itemized budget for the ensuing fiscal year prepared in accordance with §65.90 of the Wisconsin Statutes.

B. Hearing and Adoption. Upon receipt of said budget the Council shall hold a public hearing thereon and shall thereafter, at a committee of the whole meeting, make such amendments and additions as it deems necessary, all in accordance with §65.90, Wisconsin Statutes; thereupon and within three (3) days after the committee of the whole meeting, such budget shall be adopted at a special meeting called for that purpose.

C. Library Appropriation. Provision shall be made in the budget as adopted for an appropriation and a tax of one mill as provided by Ordinance 238 (March 19, 1900) to provide a library fund for the maintenance and support of Gilbert M. Simmons Library, reading rooms and branches thereof.

D. Capital Improvement Plan.

1. Purpose. The City of Kenosha shall prepare and adopt a Capital Improvement Plan to:

- a. Schedule public improvements to be constructed within a five (5) year period of time.
- b. Establish an order of priority for proposed public improvements, with due consideration to established policies and long range plans.
- c. Establish a framework for long-range financial planning and management.
- d. Assist in stabilizing tax rates through professional debt management.
- e. Coordinate major public improvement projects.
- f. Create an opportunity for citizens and public interest groups to participate in the decision making process respecting major public improvements.

2. Definition. "Capital Improvement Plan" shall mean a schedule for constructing and financing public improvements to be made within a five (5) year period of time.

Projects to be included shall be new or improved sanitary sewers, storm water drainage improvements, streets, parks, public buildings, airport improvements, harbor or marina improvements, mass transportation equipment, fire trucks, blight elimination projects, redevelopment projects, and other improvements and equipment which are expected to have a physical life expectancy exceeding five (5) years. The plan shall not include items that are normally included in the annual operating budget such as office equipment and furniture, plans and studies, automobiles, and items of a similar nature.

3. Submission of Capital Improvement Proposals. Each City department, agency, commission, authority, board or office shall file with the Department of City Development their proposal for capital improvements to be constructed within the next five (5) years. Proposals shall be made on forms prepared by the Director of City Development and shall contain detailed information, including the name of the submitter, project title, type and description of work, location, year of project commencement, year of project conclusion, costs estimates, and funding by revenue source. Justification for the project shall be included, such as, documentation of need, comprehensive or master plan in which the project is recommended, the submitter's priority rating and the estimated annual operating costs or savings.

4. Administrative Review. The Director of City Development shall forward a consolidated list of all Capital Improvement Plan proposals to an administrative committee, composed of the Mayor, City Administrator, Finance Director and the Director of City Development.

5. Review and Report by the Committees of Council and Adoption by the Common Council.

a. Submission By The Mayor. On or before the third Monday in October of each year, the Mayor shall present a proposed Capital Improvement Plan to the Common Council.

b. Recommendation of The Committee on Public Safety and Welfare. On or before November 15 of each year, the Committee on Public Safety and Welfare shall make recommendations to the Finance Committee regarding those portions of the proposed Capital Improvement Plan related to the Police Department, the Fire Department, and the Department of City Inspections.

c. Recommendation of The Public Works Committee. On or before November 15 of each year, the Public Works Committee shall make recommendations to the Finance Committee regarding those portions of the proposed Capital Improvement Plan related to the Departments of Public Works, Airport and Transportation.

d. Recommendation of Finance Committee. On or before December 1 of each year, the Finance Committee shall make a recommendation to the Common Council regarding the proposed Capital Improvement Plan.

e. Common Council Approval. Prior to the adoption of the annual operating budget, but no later than its second regular meeting in December, and after holding a public hearing and considering the recommendations of the Finance Committee, the Common Council shall adopt the Capital Improvement Plan.

2.03 TAX AND APPROPRIATIONS

D. Determination. Upon adoption of the yearly budget, the Council shall determine the amount of money to be raised by taxation for all City purposes for the ensuing fiscal year, and shall appropriate for the operation of each office, department or function the amount fixed in such budget.

E. Changes. The amount of tax to be levied, the amounts of the various appropriations and the purposes for such appropriations stated in the budget adopted shall not thereafter be changed unless authorized by a two-thirds vote of the entire membership of the Council.

2.04 INSTALLMENT PAYMENT OF TAXES - DELINQUENT TAXES

Real property taxes or personal property taxes for improvements on leased land, when either of which exceed One Hundred (\$100.00) Dollars, excluding special assessments, charges and taxes, may be paid in three (3) equal installments, each installment to be due and payable on or before the following dates: January 31, April 30, and July 31. In the event an installment is due on a date which falls on a weekend or legal holiday, the due date shall be the next regular working day.

If the first installment of real property taxes or of personal property taxes for improvements on leased land is not paid on or before 5 working days after January 31, the entire amount of the remaining unpaid taxes is delinquent as of February 1. If the second or any subsequent installment payment of real property taxes or of personal property taxes for improvements on leased land is not paid in full on or before 5 working days after the specified due date, the entire amount of the remaining unpaid taxes is delinquent as of the first day of the month after the payment is due.

Special assessments, charges and taxes shall be due on January 31, and paid in full on or before 5 working days after January 31. Personal property taxes, except for personal property taxes for improvements on leased land, shall be due on January 31, and paid in full on or before 5 working days after January 31. Any of such taxes which are not paid in full on or before 5 working days after January 31 are delinquent as of February 1.

All real property taxes, special assessments, special charges and special taxes that become delinquent and are paid on or before July 31, and all delinquent personal property taxes, whenever paid, shall be paid, together with interest and penalties charged from the preceding February 1. After July 31, real property taxes, special assessments, special charges and special taxes delinquencies shall be paid to the County Treasurer in accordance with §74.12 (10), Wisconsin Statutes.

2.041. DISBURSEMENT OF STATE CREDITS TO THE CITY

Pursuant to Wis. Stat. §79.10 (7m)(cm) 1.a., the City approves the Wisconsin Department of Administration making distributions of the amounts determined under Wis. Stat. §§79.10 (4), (5), and (5m), directly to the City.

2.05 DISBURSEMENTS

City funds shall be disbursed in accordance with §66.0607 of the Wisconsin Statutes.

2.06 PAYMENT OF FEES

Payment of all fees for licenses or permits issued by the City, or any department thereof, shall be payable only at the office of the Clerk/Treasurer.

2.07 ACCOUNTS AND AUDIT

All accounts shall be kept by or under the supervision of the Clerk/Treasurer on forms prescribed or approved by the Mayor. All City accounts shall be audited by a certified public accountant to be designated by the Council, or by an accountant assigned by the State.

The City Clerk/Treasurer is empowered to destroy the following records after completion of an audit, but not less than seven (7) years after payment of the sum involved in the applicable transactions, namely:

- a. Vouchers and all supporting documents pertaining to payments from the City treasury.
- b. Cancelled checks.
- c. Municipal bonds and coupons (general obligation, special assessment or mortgage).
- d. License applications.
- e. License stubs or duplicates.
- f. Requisitions.
- g. Purchase Orders.
- h. Duplicate receipts.
- i. Employment, time and earning records of City employees.

2.08 CLAIMS

A. Payments may be made from the City treasury after the Clerk/Treasurer shall have audited and approved each claim as a proper charge against the treasury, and shall have undersigned his approval thereon after having determined that the following conditions have been complied with:

- a. That funds are available therefor pursuant to the budget approved by the Council, or by other action of Council.
- b. That the item or service covered by such claim has been duly authorized by the proper official, department head or board or commission.
- c. That the item or service has been actually supplied or rendered in conformity with such authorization.
- d. That the claim is just and valid pursuant to law. The Director of Finance may require the submission of such proof and evidence to support the foregoing as in his discretion he may deem necessary.

B. The Director of Finance shall file with the Council not less than monthly a list of claims approved, showing the date paid, name of claimant, purpose and amount.

2.09 SUBSTITUTION FOR TREASURER'S BOND

The City of Kenosha, Wisconsin, is hereby obligated to pay all State and county taxes required by law to be paid by the Clerk/Treasurer to the County Treasurer, if such Director of Finance shall fail to do so. This obligation is assumed in lieu of the Treasurer's Bond required by §70.67 of the Wisconsin Statutes, 1947.

2.095 COST RECOVERY FOR INSTALLATION OF CITY PUBLIC INFRASTRUCTURE

A. Definitions.

"**Applicant**" means the party responsible by a development agreement with the City to install City Public Infrastructure.

"**City Public Infrastructure**" means public improvements identified in paragraphs 2.10 B. 1 through 3 and 5, specifically including, but not limited to, water and sewer main extensions.

"**Total Estimated Cost**" means the full cost of City Public Infrastructure estimated by the Department of Public Works, which full costs include engineering and design services, inspection and testing services, legal services, finance carrying charges, grading, utility installation or alteration, infrastructure installation, necessary street resurfacing, and other direct and indirect costs, whether performed by or on behalf of the City.

B. City Public Infrastructure within the City of Kenosha may be installed subject to the imposition of special assessments against benefited properties. City Public Infrastructure, regardless of whether a special assessment will be imposed, may be financed in advance of installation on a "cost advanced" basis; in the event that a special assessment is levied for the installation made on the cost advancement basis, the Common Council may proportionately reimburse the Applicant from the special assessment collections.

C. Special Assessment. City Public Infrastructure shall be financed by special assessments when deemed advisable by the Common Council. In general, the special assessment method shall be used for City Public Infrastructure in areas in immediate need of service or which are deemed likely to develop and need service within ten (10) years. All special assessments shall be levied in accordance with the provisions of Chapter 66 of the Wisconsin Statutes and of these ordinances, specifically including Section 2.10.

D. Cost Advances. City Public Infrastructure will be financed in advance of installation by cost advancements when cost advances are deemed advisable by the Common Council. In general, the cost advancement method shall be used only when City Public Infrastructure is required by a development agreement. Where City Public Infrastructure installations are authorized on a cost advancement basis the procedure shall be as follows:

1. The Applicant shall deposit with the City Clerk/Treasurer a sum sufficient to pay the Total Estimated Cost.
2. Such deposit shall be made before construction is started or contracted. If the actual cost of the City Public Infrastructure installations is less than the Total Estimated Cost deposited, the excess of the deposit over the cost shall be refunded to the Applicant within 30 days after final payment for the completed project. If the actual cost exceeds the deposit, the Applicant shall pay the difference within thirty (30) days of invoice from the City; while a deficiency exists, an occupancy permit will not be issued for the development of the Applicant associated with the City Public Infrastructure, regardless of any provision to the contrary in an agreement.
3. Any properties benefited by the City Public Infrastructure after its installation are subject to a special assessment if the Common Council directs, for the proportionate share of the actual costs of installation. In the event that a special assessment is to be imposed, the Public Works Department shall take the appropriate steps consistent with applicable law to effectuate the special assessment. In the event that special assessment are to be imposed, owners of property benefited by the City Public Infrastructure, other than the Applicant, shall pay to the City their special assessments for the installation of the City Public Infrastructure.
4. Special assessments collected by the City under paragraph 3. above shall be paid to the Applicant or its assigns unless specifically provided otherwise in writing.

2.10 SPECIAL ASSESSMENTS

A. Procedure. Any special assessment for special benefits conferred upon property due to municipal work or improvement shall be levied and collected in accordance with §66.0703, Wis. Stats.

B. Installments. The following public improvements are deemed to specially benefit the abutting property and are subject to a special assessment payable over the period of time herein specified, said time periods running from the date of notice of the special assessment to the abutting owner:

1. Paving of streets, curbs and gutters including any appurtenant infrastructure for stormwater conveyance is payable in ten (10) annual installments.
2. Construction, repair or replacement of sidewalks is payable:
 - a. in three (3) annual installments where the cost thereof exceeds One Hundred (\$100.00) Dollars.
 - b. in a lump sum of one (1) annual payment where the cost thereof is under One Hundred (\$100.00) Dollars.
 - c. in ten (10) annual installments when constructed in conjunction with street paving.
3. Grading and graveling streets is payable:
 - a. in three (3) annual installments.
 - b. in ten (10) annual installments when constructed in conjunction with street paving.
4. Correction of illegal sump pump discharge by the installation of a sump pump service lateral to storm sewer system is payable in three (3) annual installments.
5. All other public improvements authorized by law are payable in a lump sum in one (1) annual payment
6. Special charges for current services in accordance with §66.0627, Wisconsin Statutes, in a lump sum of one (1) annual payment.

C. Interest.

1. The interest rate on all special assessments shall be seven and one-half (7.5%) percent per annum from the date of billing, with each installment including a proportionate part of the principle of the special assessment determined by the number of installments and one year's interest upon the unpaid balance.

2. The first installment shall further include interest at the rate of seven and one-half (7.5%) percent per annum on the period of time from the date of billing to the last day of December in the year in which the assessment is billed.

3. Where the owner of the property assessed elects to pay the amount of the assessment in full within thirty (30) days from the date of billing there shall be no interest charged thereon.

D. Tax Roll. The first installment shall be placed on the first tax roll prepared after said instruments shall have been determined as a special tax on the property upon which the special assessment was levied and thereafter this tax shall be treated in all respects as any other municipal tax upon real property, except that the full amount shall be due and payable on the tax bill by January 31st of each year. Subsequent installments shall be entered in like manner and with like effect on each of the annual rolls thereafter until all are levied.

If any special assessment or installment thereon so entered on the tax roll shall not be paid to the Clerk/Treasurer with the other real property taxes, it shall be returned to the county as delinquent and accepted and collected by the county, as provided for in Chapter 74, Wisconsin Statutes.

E. Notice of Installment Assessment. Whenever any special assessment for public improvements are permitted to be paid in installments, the City Clerk shall cause a notice to be published in the official newspaper in the following form:

INSTALLMENT ASSESSMENT NOTICE

Notice is hereby given that a contract has been let for (describe improvement) and that the amount of the special assessment therefor has been determined as to each parcel of real estate affected thereby and a statement of the same is on file with the City Clerk; it is proposed to collect the same in _____ installments with interest thereon at seven and one-half (7.5%) percent per annum; that all assessments will be collected in installments as above provided except such assessments on property where the owner of the same shall elect to and does pay in full the special assessment on this property within thirty (30) days of the billing date shall be without interest.

Dated:

City Clerk of Kenosha, Wisconsin

F. Payment Before Due. After the time for making such election and payment in full as provided in the above notice, shall have expired the balance of any assessment herein provided for may be paid in full before due, as follows:

1. During the period before the first Installment is placed on the tax roll by paying interest at the rate of seven and one-half (7.5%) percent per annum from the date of billing through the last day of the month in which the payment is offered.

2. Anytime after the first installment has been placed on the tax roll by paying interest of seven and one-half (7.5%) percent per annum from January 1 next preceding through the last day of the month in which payment is offered.

3. In order to allow time for tax roll preparation, no payment will be accepted on assessments billed before November 2 during the period of December 1 through December 31 of the year in which the assessment is billed.

G. Schedule of Assessments. A schedule of assessments and installments thereof shall be recorded in the Office of the City Clerk forthwith.

1. **Fee.** There shall be a Fifteen (\$15) Dollar per parcel fee payable by any party who makes an oral or written request to the Department of Public Works to have that Department check the schedule of contemplated special assessments on their behalf and issue an oral or written report thereon.

2. **Policy.** It is determined by the Common Council of the City of Kenosha, Wisconsin that the above charge is not in violation of the Public Records Law as said charge is for the compilation of a new record and not for the disclosure, production of, or copying of an existing record.

H. Deferment of Special Assessments-Agricultural Property. Whenever the City shall cause to be constructed a water or sanitary main or appurtenances thereof in any highway, street, or right-of-way within the City, fronting property which is zoned "Agricultural", the special assessment therefor will be deferred until such time as the property is rezoned to other than "Agricultural" zoning. Should the "Agricultural" parcel of real estate be split into smaller parcels and/or rezoned for other uses, said special assessments shall become payable, upon the terms provided for in this Ordinance, upon the effective date of such rezoning. The special assessment rate, which shall be levied against the rezoned property, shall be the rate in effect at the time of the rezoning.

Special assessments against any parcel of agriculturally zoned real estate which is outside of the City limits and the subject of a petition to annex to the City and rezone to any industrial zoning district shall be deferred until there is a change of use evidenced by a Building Permit application being made to construct a building or structure upon any portion of the annexed real estate under circumstances where any portion

of the annexed land is placed in a Tax Incremental Financing District. At such time as a Building Permit application is made, all special assessments levied shall be due and payable.

2.11 PARK ACQUISITION AND IMPROVEMENT FUND

A. There is hereby established a fund to be known as the Park Acquisition and Improvement Fund which shall only be used and expended by the Common Council for the purchase, condemnation, or lease of property for park purposes, or for the improvement of park land.

B. The City Clerk/Treasurer is hereby authorized and directed, without further approval of the Common Council, to deposit in said fund the following:

1. The net proceeds from the sale or lease of any park land or buildings.
2. Any sums paid by subdividers in lieu of dedicating land for public purposes under Chapter 17 of the Code of General Ordinances.
3. Permit fees for use of park buildings and land.
4. Appropriations or transfer of funds specifically made to the Fund by the Common Council.

2.12 TRAVEL EXPENSES

A. Travel Expense Vouchers Required. No elected City Official, Department Head or City employee shall receive travel expenses unless said expenses are submitted on a "Travel Expense Voucher".

B. The "Travel Expense Voucher" shall contain the following information:

1. Purpose of Travel.
2. Dates of Travel.
3. Destination.
4. Type of Transportation Used. In the event a private automobile is used for City business, the individual driving said automobile shall be reimbursed at the maximum allowable rate permitted by the United States Internal Revenue Service.
5. Cost of Meals.
6. Cost of Room.
7. A statement to be signed by the individual involved certifying the correctness of the expenses shown on the voucher.
8. Per Diem in accordance with Section 1.01 of the Code of General Ordinances for the City of Kenosha, Wisconsin.

C. Receipts Required. Each Travel Expense Voucher shall have attached hereto proper receipts marked "paid" for any expense claimed in excess of \$10.00.

D. Limitation on Expenses. On any trip in excess of three hundred (300) miles, the amount authorized for transportation shall not exceed the "Tourist Class" air fare.

E. The Director of Finance shall maintain a separate file containing copies of all Travel Expense Vouchers submitted during a given calendar year. Said file shall be kept current and open to public inspection during office hours.

2.13 PRESERVATION OF RECORDS, MICROFILM

Any Public Record of the City of Kenosha, including those records kept by the Police Department, Fire Department and Water Utility, may be kept and preserved by the use of microfilm or other reproductive device meeting the standards established in §16.80 (7) of the Wisconsin Statutes.

2.15 COMMISSIONS--CITY PROPERTY

Appropriate City officials are authorized to pay, upon consummation of a sale or lease, a commission to a realtor who finds a buyer or lessee for City property, said commission to be in an amount customary in

the Kenosha area for such services. However, such payment is not required in the absence of an appropriate agreement executed by the City and realtor, providing for the terms and conditions of payment thereof prior to the sale or lease.

2.16 HOTEL-MOTEL ROOM TAX

A. Definitions.

1. Hotel or Motel. "Hotel" or "Motel" means a building or group of buildings in which the public may obtain accommodations for a consideration, including, without limitation, such establishments as inns, motels, hotels, tourist houses or courts, lodging houses, rooming houses, summer camps, apartment hotels, resort lodges and cabins, and any other building in which accommodations are available to the public, except accommodations rendered for a continuous period of more than one month and accommodations furnished by hospitals, sanitariums, or nursing homes, or by corporations or associations organized and operated exclusively for religious, charitable or educational purposes provided no part of the net earnings of such corporations and associations inure to the benefit of any private shareholder or individual.

2. Gross Receipts. "Gross Receipts" has the meaning, insofar as applicable, as defined in Section 77.51(4), Wisconsin Statutes.

3. Transient. "Transient" means any person residing for a continuous period of less than one (1) month in a hotel, motel or furnished accommodations available to the public.

B. Room Tax Imposed. Pursuant to §66.0615, Wisconsin Statutes, a tax is imposed on the privilege and service of furnishing, at retail, rooms or lodging to transients by hotel keepers, motel operators, and other persons furnishing accommodations that are available to the public, irrespective of whether membership is required for the use of the accommodations. Such tax shall be at the rate of eight (8%) percent of the gross receipts from such retail furnishing of rooms or lodging. Such tax shall not be subject to the selective sales tax imposed by §77.52(2)(a), Wisconsin Statutes. The proceeds of such tax shall be remitted monthly to the City Clerk/Treasurer.

There is hereby created a City of Kenosha Tourism Promotion Fund to be financed by the allocation and distribution of ninety (90%) percent of all revenues collected under this Ordinance. Such funds shall be paid to the Kenosha Area Tourism Corporation, upon the condition that its By-Laws are approved by the Common Council.

The City Director of Finance shall make payments of monies from the Tourism Promotion Fund to the Kenosha Area Tourism Corporation in the following manner: The City Director of Finance will estimate the total revenues to be anticipated to be allocated to the Tourism Promotion Fund based on those facilities subject to this Ordinance in operation on January 1st of the year for which the estimate is made. One-fourth of this estimate will be paid to the Kenosha Area Tourism Corporation on January 15th, April 15th, July 15th and October 15th. The April 15th payment will be adjusted for actual revenue allocated to the Tourism Promotion Fund in the preceding year and the City will notify the Kenosha Area Tourism Corporation by March 1st as to the amount of such adjustment. The Director of Finance will advance to the Tourism Promotion Fund from the General Fund such amounts as are necessary to fund the quarterly payments for the balance of the year. The amount so included will be those revenues allocated to the Tourism Promotion Fund through the end of the month preceding the quarterly payment date. The Kenosha Area Tourism Corporation shall, as a condition of continued funding hereunder, be required to have an audit for its fiscal year performed by a Certified Public Accountant, which is to be furnished to the City Director of Finance upon completion, and upon the further condition that said Corporation submit to the Mayor and Common Council, in May of each calendar year, a detailed report of its efforts and accomplishments related to the promotion of tourism during the preceding calendar year.

C. Application for Permit.

1. Permit. Every person furnishing rooms or lodging shall file with the City Clerk/Treasurer an application for a permit for each place of business. Every application for a permit shall be made upon a form prescribed by the City Clerk/Treasurer and shall set forth the name under which the applicant intends

to transact business, location of his/her place of business, and such other information as the City Clerk/Treasurer requires. The application shall be signed by the owner if a sole proprietor and, if not a sole proprietor, by the person authorized to act on behalf of the business. At the time of making an application the applicant shall pay to the City Clerk/Treasurer a fee of Ten (\$10.00) Dollars for each permit.

2. Security Bond. In order to protect the revenue of the City, the City Clerk/Treasurer may require any person liable for the tax imposed to file with him before or after a permit is issued, such security, not in excess of Five Thousand (\$5,000) Dollars, as the City Clerk/Treasurer determines. If any taxpayer fails or refuses to place such security, the City Clerk/Treasurer may refuse or revoke such permit. If any taxpayer is delinquent in the payment of the taxes imposed by this Section, the City Clerk/Treasurer may, upon ten (10) days' notice and after giving the taxpayer an opportunity to confer, recover the taxes, interest and penalties from the security placed with the City Clerk/Treasurer by such taxpayer. No interest shall be paid or allowed by the City to any person for the deposit of such security.

3. Issuance of Permit. After compliance with **1.** and **2.**, the City Clerk/Treasurer shall grant and issue to each applicant a separate permit for each place of business within the City. Such permit is not assignable and is valid only for the person in whose name it is issued and for the transaction of business at the place designated therein. It shall at all times be conspicuously displayed at the place for which it is issued.

4. Revocation of Permit. Whenever any person, party, firm or corporation fails to comply with this Ordinance, the City Clerk/Treasurer may, upon ten (10) days notification and after affording such person, party, firm or corporation the opportunity to show cause why the permit should not be revoked, revoke or suspend any or all of the permits held by such person, party, firm or corporation. The City Clerk/Treasurer shall give notice of the suspension or revocation to the party affected and shall not issue a permit after the revocation of a permit unless he is satisfied that the former holder of the permit will comply with the provisions of this Ordinance. A fee of Fifty (\$50) Dollars shall be imposed for the renewal or issuance of a permit which has been previously suspended or revoked. The decision of the City Clerk/Treasurer to revoke or suspend a permit may be appealed to the Common Council of the City of Kenosha.

D. Records to be Kept. Every person liable for the tax imposed by this Section shall keep or cause to be kept such records, receipts, invoices and other pertinent papers in such form as the City Clerk/Treasurer requires.

E. Administration and Payment of Taxes. This Section shall be administered by the City Clerk/Treasurer. The tax imposed for the month is due and payable before the last day of the following month.

F. Returns To Be Filed; Monitoring and Auditing. A return shall be filed with the City Clerk/Treasurer by those furnishing at retail such rooms and lodging on or before the same date on which such tax is due and payable. Such return shall show the gross room receipts of the preceding calendar month from such retail furnishing of rooms or lodging, and the amount of the tax imposed for such period, and such other information as the City Clerk/Treasurer deems necessary to administer this Section. The City Clerk/Treasurer may, for good cause, extend the time of filing any return, but not longer than one (1) month from the filing date.

The City Clerk/Treasurer shall provide a copy of such returns to the Kenosha Area Tourism Corporation, who shall act as the agent of the City for purposes of monitoring and auditing such returns. From time to time, but at least once every calendar year, the Kenosha Area Tourism Corporation shall provide the City Clerk/Treasurer with a report respecting such monitoring and auditing. The Kenosha Area Tourism Corporation shall use payments made by the City under this Ordinance to fund said monitoring and auditing.

G. Records to be Confidential. All tax returns, schedules, exhibits, writings or audit reports relating to such returns on file with the City Clerk/Treasurer are confidential, except the City Clerk/Treasurer may divulge their contents to the following persons:

1. The person who filed the return.

2. Officers, agents, or employees of the Federal Internal Revenue Service or the State Department of Revenue.

3. Officers, employees, or agents of the City, as may be necessary to enforce collection.

H. Determination of Tax. The City Clerk/Treasurer may, by office or field audit, determine the tax required to be paid to the City or the refund due to any person under this Section. This determination may be made upon the basis of the facts contained in the return being audited or on the basis of any other information within the City Clerk/Treasurer's possession. One or more such office audit determinations may be made of the amount due for any one or for more than one period. The City Clerk/Treasurer may examine and inspect the books, records, memoranda and property of any person in order to verify the tax liability of that person or another person. The City Clerk/Treasurer may make a determination of tax at any time.

I. Failure to File Return. If any person fails to file a return as required by this Ordinance, the City Clerk/Treasurer shall make an estimate of the amount of the gross receipts. Such estimate shall be made for the period for which such person failed to make a return and shall be based upon any information which is in the City Clerk/Treasurer's possession or may come into his possession. On the basis of this estimate, the City Clerk/Treasurer shall compute and determine the amount required to be paid to the City, adding to the sum thus arrived at a penalty equal to ten (10%) percent thereof. One or more such determinations may be made for one or more than one period.

J. Interest on Unpaid Taxes and Refunds. All unpaid taxes shall bear interest at the rate of twelve (12%) percent per annum from the due date of the return until the first day of the month following the month in which the tax is paid or deposited with the City Clerk/Treasurer. All refunded taxes shall bear interest at twelve (12%) percent per annum from the due date of the return until the first day of the month following the month in which such taxes are refunded. An extension of time within which to file the return shall not operate to extend the due date of the return for purposes of interest computation. If the City Clerk/Treasurer determines that any overpayment of tax has been made intentionally, or by reason of carelessness or neglect, or if the tax which was overpaid was not accompanied by a complete return, he shall not allow any interest thereon.

K. Late Filing Fee. Delinquent tax returns shall be subject to a Twenty-five (\$25) Dollar late filing fee.

L. Delinquent Taxes. The tax imposed by this Section shall become delinquent if not paid on or before the due date of the return, or before the expiration of an extension period, if one has been granted. If a return is filed late, or there is no return filed, the due date for the taxes imposed is the due date of the return.

M. False or Fraudulent Return. If a false or fraudulent return is filed with the intent in either case to defeat or evade the tax imposed by this Ordinance, a penalty of fifty (50%) percent of the tax due shall be paid in addition to the tax interest and late filing penalty.

N. Separability or Conflict. If any section, subsection, paragraph, subparagraph, sentence, clause, phrase or portion of this Section is for any reason held invalid or unconstitutional by any court of competent jurisdiction, such provisions and such holding shall not affect the validity of the remaining portions of this Section.

O. Penalty. Any person, firm, party or corporation who shall violate any provision of this Ordinance shall, upon conviction, be punished by a fine of not less than Fifty (\$50.00) Dollars nor more than Two Hundred (\$200.00) Dollars, plus costs, or by imprisonment for not more than thirty (30) days, if in default of payment of such fine and costs. Each day's failure to comply with any provision of this Ordinance shall constitute a separate violation.

2.17 INDUSTRIAL REVENUE BONDS

Applicants for City Industrial Bond financing must, as a condition of having their application processed by the City, pay to the City Clerk/Treasurer a Five Hundred (\$500) Dollar nonrefundable, nonproratable fee to cover the direct and indirect cost incurred by the City in processing and reviewing said application, whether or not Industrial Revenue Bonds are ever issued. Applicants must pay for the actual, total cost

incurred by the City in retaining bond counsel to review the legality and propriety of Industrial Revenue Bond Financing. Applicants must also pay all publication expenses incurred by the City in processing said bond issue, including the expense of publishing legal notices and Council Proceedings.

Further, the City Clerk/Treasurer shall require that the estimated costs of the City's retained bond counsel and publication expense be paid in advance to said Treasurer to guarantee payment thereof. The City Clerk/Treasurer shall require applicants to submit a standard form of application as a condition of the processing thereof.

The Mayor may approve written in-house procedures to be utilized in processing Industrial Revenue Bonds.

2.18 KENOSHA LAKESHORE BUSINESS IMPROVEMENT DISTRICT

A. Authority and Purpose. This Ordinance is established under the authority of §66.1109, Wisconsin Statutes, for the purpose of creating a Business Improvement District which would allow businesses within said District to develop, to manage and promote said District and to establish an assessment method to fund permitted activities.

B. Creation of District-Boundaries. There is herein and hereby created a Business Improvement District known as "KENOSHA LAKESHORE", which area is roughly bounded by Sheridan Road, 49th Street, the Kenosha Harbor, 5th Avenue and 60th Street said boundaries more specifically described on the annexed map, which is incorporated herein by reference.

C. Special Assessment Method. Special assessment rates shall be determined by District budgets which are approved by the Common Council, based upon the District's current assessed valuation. Real property used exclusively for residential and manufacturing purposes are exempt from this assessment.

D. District Board of Directors. The Board of Directors of the District, which shall have all of the powers provided for within §66.1109, Wisconsin Statutes, shall consist of eleven (11) members, of which a minimum of seven (7) shall own or occupy real property in the District, who shall be appointed by the Mayor and confirmed by the Common Council. The term of Board members shall be three (3) years.

The terms of Board members shall be staggered and to accomplish that objective, three (3) Board members shall be appointed for an initial term of one (1) year, four (4) for an initial term of two (2) years and four (4) for an initial term of three (3) years.

E. Operating Plans and Budgets. The District Board of Directors shall submit an annual operating plan and budget to the City Clerk on or before November 1st of each year. The approval of the Common Council, in Resolution form, must be obtained to effectuate the proposed annual operating plan and budget.

F. Segregated Account. All special assessments received by the City from the District and all other appropriations by the City or other monies received by the City for the benefit of the District, shall be placed in a segregated account in the City Treasury. No disbursements from the account may be made except to reimburse the City for appropriations other than special assessments, to pay the costs of audits required by law or upon order of the Board for the purpose of implementing the operating plan. Upon termination of the KENOSHA LAKESHORE BUSINESS IMPROVEMENT DISTRICT by the City, all monies collected by special assessment remaining in the account shall be disbursed to the owners of specially assessed property within the District, in the same proportion as the last collected special assessment.

G. Documents and Proceedings. All documents and proceedings involving the creation of said District are on file in the Office of the City Clerk and incorporated herein by reference.

(See Appendix - Map 2.18)

2.19 UPTOWN BUSINESS IMPROVEMENT DISTRICT

A. Authority and Purpose. This Ordinance is established under the authority of §66.608, Wisconsin Statutes, for the purpose of creating a Business Improvement District which would allow businesses within said District to develop, to manage and promote said District and to establish an assessment method to fund permitted activities.

B. Creation of District-Boundaries. There is herein and hereby created the UPTOWN BUSINESS IMPROVEMENT DISTRICT (BID). This District is generally bounded by Roosevelt Road and 64th Street, 24th Avenue, 60th Street, and an area directly east of 22nd Avenue, said boundaries being more specifically described on the annexed map which is incorporated herein by reference.

C. Special Assessment Method. Special assessment rates shall be determined by District budgets which are approved by the Common Council, based upon the District's current assessed valuation. Real property used exclusively for residential and manufacturing purposes are exempt from this assessment.

D. District Board of Directors. The Board of Directors of the District, which shall have all of the powers provided for within §66.1109, Wisconsin Statutes, shall consist of nine (9) members, of which a minimum of seven (7) shall own or occupy real property in the District, who shall be appointed by the Mayor and confirmed by the Common Council. The term of Board members shall be three (3) years.

The terms of Board members shall be staggered and to accomplish that objective, three (3) Board members shall be appointed for an initial term of one (1) year, three (3) for an initial term of two (2) years, and three (3) for an initial term of three (3) years.

E. Operating Plans and Budgets. The District Board of Directors shall submit an annual operating plan and budget to the City Clerk on or before November 1st of each year. The approval of the Common Council, in Resolution form, must be obtained to effectuate the proposed annual operating plan and budget.

F. Segregated Account. All special assessments received by the City from the District and all other appropriations by the City or other monies received by the City for the benefit of the District, shall be placed in a segregated account in the City Treasury. No disbursements from the account may be made except to reimburse the City for appropriations other than special assessments, to pay the costs of audits required by law or upon order of the Board for the purpose of implementing the operating plan. Upon termination of the UPTOWN BUSINESS IMPROVEMENT DISTRICT by the City, all monies collected by special assessment remaining in the account shall be disbursed to the owners of specially assessed property within the District, in the same proportion as the last collected special assessment.

G. Documents and Proceedings. All documents and proceedings involving the creation of said District are on file in the Office of the City Clerk and incorporated herein by reference.

(See Appendix - Map 2.19)

2.20 EMERGENCY MEDICAL SERVICE USER FEES

A. Establishment of User Fees. The Common Council may, from time to time, establish a schedule of Emergency Medical Service User Fees for residents and nonresidents of the City, covering transportation and nontransportation services, through a Resolution adopted at a duly noticed and convened meeting.

B. Section 66.30 Cooperative Agreements. The Common Council may enter into Section 66.30 Cooperative Agreements with other local units of government which may establish a schedule of Emergency Medical Service User fees, which is different from that established by Resolution.

C. Persons Insured By The City. The Emergency Medical Service User Fees shall not be applicable to persons who receive their primary health insurance through the City of Kenosha.

2.21 EMERGENCY ACTION - RECOVERY OF ENVIRONMENTAL CLEANUP COSTS

A. Definitions.

1. Emergency Action. "Emergency Action" shall mean all exigent activities conducted in order to prevent or mitigate harm to the public health and safety and the environment from a release or threatened release of any material into or upon land, water or air.

2. Person. Person shall include any individual, corporation, association, partnership, firm, trustee, legal representative, or any combination thereof.

3. Recoverable Expenses. Recoverable Expenses shall include those expenses of the City of Kenosha that are reasonable, necessary and allocable to an emergency action. Recoverable expenses shall not include normal budgeted expenditures that are incurred in the course of providing what are traditionally City services and responsibilities, such as routine firefighting protection. Expenses allowable for recovery may include, but are not limited to:

a. Disposable materials and supplies consumed and expended specifically for the purpose of the emergency action.

b. Compensation of employees for the time and efforts devoted specifically to the emergency action.

c. Rental or leasing of equipment used specifically for the emergency action (e.g., protective equipment or clothing, scientific and technical equipment).

d. Replacement costs for equipment owned by the City that is contaminated beyond reuse or repair, if the equipment was a total loss and the loss occurred during the emergency action (e.g., self-contained breathing apparatus irretrievably contaminated during the response).

e. Decontamination of equipment contaminated during the response.

f. Special technical services specifically required for the response (e.g., costs associated with the time and efforts of technical efforts or specialists not otherwise provided for by the City).

g. Other special services and equipment specially required for the emergency action.

h. Laboratory costs of analyzing samples taken during the emergency action.

i. Any cost of cleanup, storage or disposal of the released material.

j. Costs associated with the services, supplies and equipment procured for a specific evacuation of persons or property.

k. Medical expenses incurred as a result of response activities.

l. Legal expenses that may be incurred as a result of the emergency action, including efforts to recover expenses pursuant to this Ordinance.

4. Release. Release shall mean any spilling, leaking, pumping, pouring, emitting, emptying, discharging, injecting, escaping, dumping or disposing into or upon land, water or air, of any material.

5. Threatened Release. Threatened release shall mean any imminent or impending event potentially causing but not resulting in a release, but causing the City to undertake an emergency action.

B. Liability. Any person causing or responsible for a release or threatened release resulting in an emergency action shall be liable to the City for the recoverable expenses resulting from the emergency action. There shall be a rebuttal presumption that any person owning or controlling property causing a release or threatened release is responsible for such release or threatened release.

C. Itemization Of Recoverable Costs. City personnel and departments involved in an emergency action shall keep an itemized record of recoverable expenses resulting from an emergency action. Promptly after completion of an emergency action, the appropriate City department shall certify those expenses to the City Finance Department.

D. Invoices. The City Finance Department shall submit a written itemized invoice for the total expenses incurred by the City for the emergency action to the responsible person and a written notice that unless the amounts are paid in full to the City within thirty (30) days after the date of the mailing of the invoice and notice, the City Finance Department will cause the invoice to be collected by a special assessment, where appropriate, or otherwise referred to the City Attorney's Office for collection.

E. Special Assessments. The City may specially assess the real property within the City, which is the site of emergency action, owned by the person causing or responsible for the emergency action, for the full amount of the recoverable expenses, plus the costs of administration and collection. With respect to real property without the City, which is the site of emergency action, owned by the person causing or responsible for the emergency action, the City may request the municipality in which the property lies to specially assess said recoverable expenses where emergency action was taken by the City at the request of said municipality or under the terms of a Mutual Aid Agreement.

F. Civil Suit. The City Attorney may bring a civil action for recovery of the recoverable expenses against any and all persons causing or responsible for the emergency action.

G. Conflict Of Laws. Nothing in this Ordinance shall be construed to conflict with State or Federal laws requiring persons causing or responsible for releases or threatened releases from engaging in remediation activities and/or paying the costs thereof.

2.22 MANAGEMENT IDENTIFICATION BY APPLICANTS FOR CITY FUNDING

A. Definitions.

1. **"City Property"** means all property, real or personal, tangible or intangible, owned or controlled by the City of Kenosha. The term "city property" includes park property owned by the City or administered pursuant to Wisconsin Statutes by the Parks Commission.

2. **"Funding"** for purposes of this section is broadly construed to include the provision by the City of anything of value greater than ten thousand dollars (\$10,000.00) for less than full consideration in return. The term specifically includes, but is not limited to, grants, loans for at interest rates at less than market rates, rents for city property at less than market rates, waivers of user fees for city property. The term "funding" specifically excludes the provision of parks for organized sports programs, library material or meeting rooms, museum meeting rooms, or the closure of streets, the temporary right to occupy the public right of way pursuant to Chapter 5 of the Code of General Ordinances, or trees for lawn park areas.

3. **"Management Identification"** means the provision of name, annual compensation, and benefit package description of all officers, directors, managers, members, partners, and employees who receive at least \$50,000.00 per year from the organization in annual income of the type reportable to the Internal Revenue Service.

4. **"Organization"** means any non-stock corporation, non-profit association or any other non-profit legal entity other than a natural person.

B. Requirement.

Prior to deliberation on the request for funding by the City of Kenosha, an organization must first file management identification with the City.

C. Place of Filing Management Identification.

If an application is required by the City of the organization for funding, management identification shall be filed with the office receiving the application. If no application is required by the City of the organization for funding, management identification shall be filed with the City Clerk.

APPENDIX Table 2.18

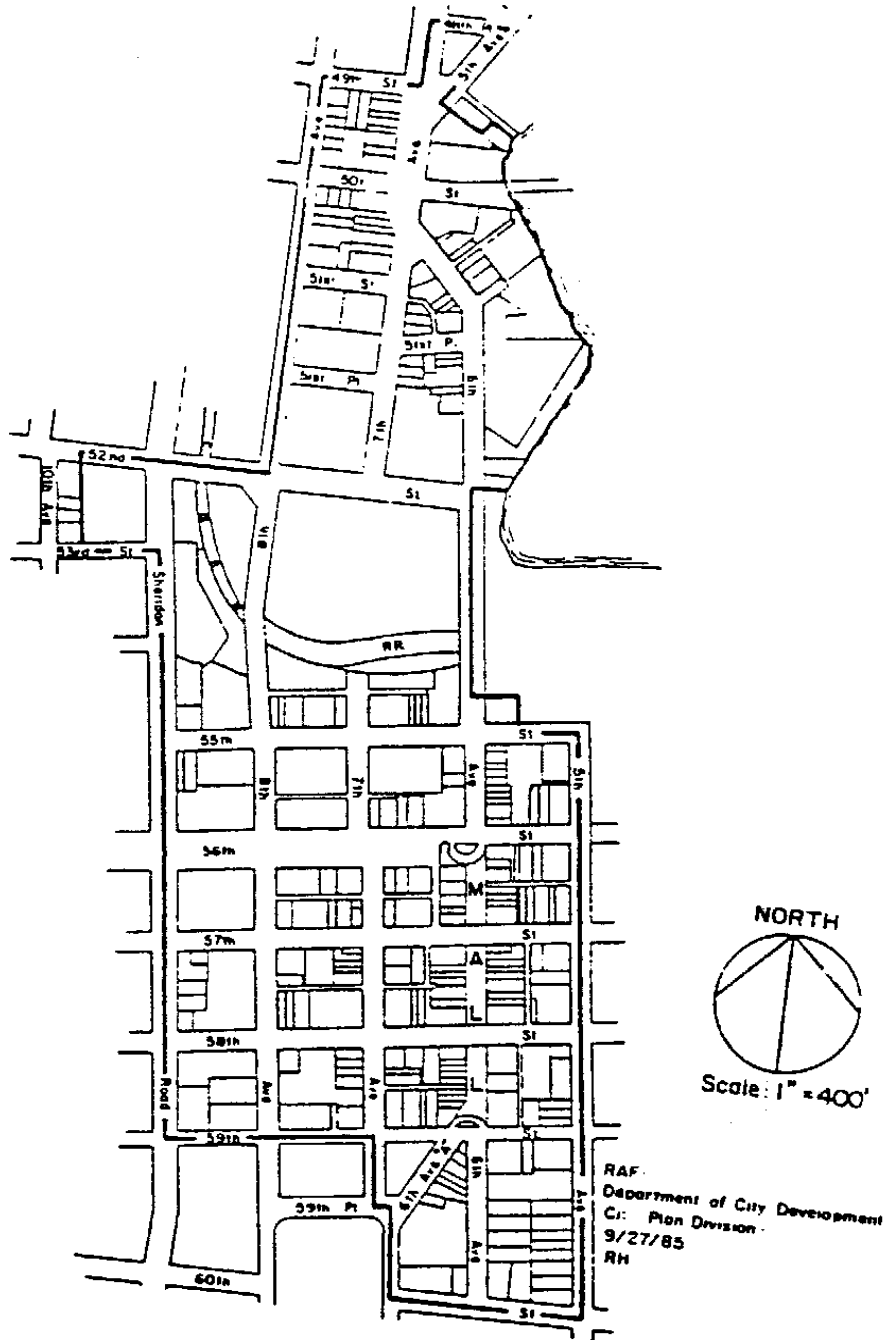

APPENDIX Table 2.19

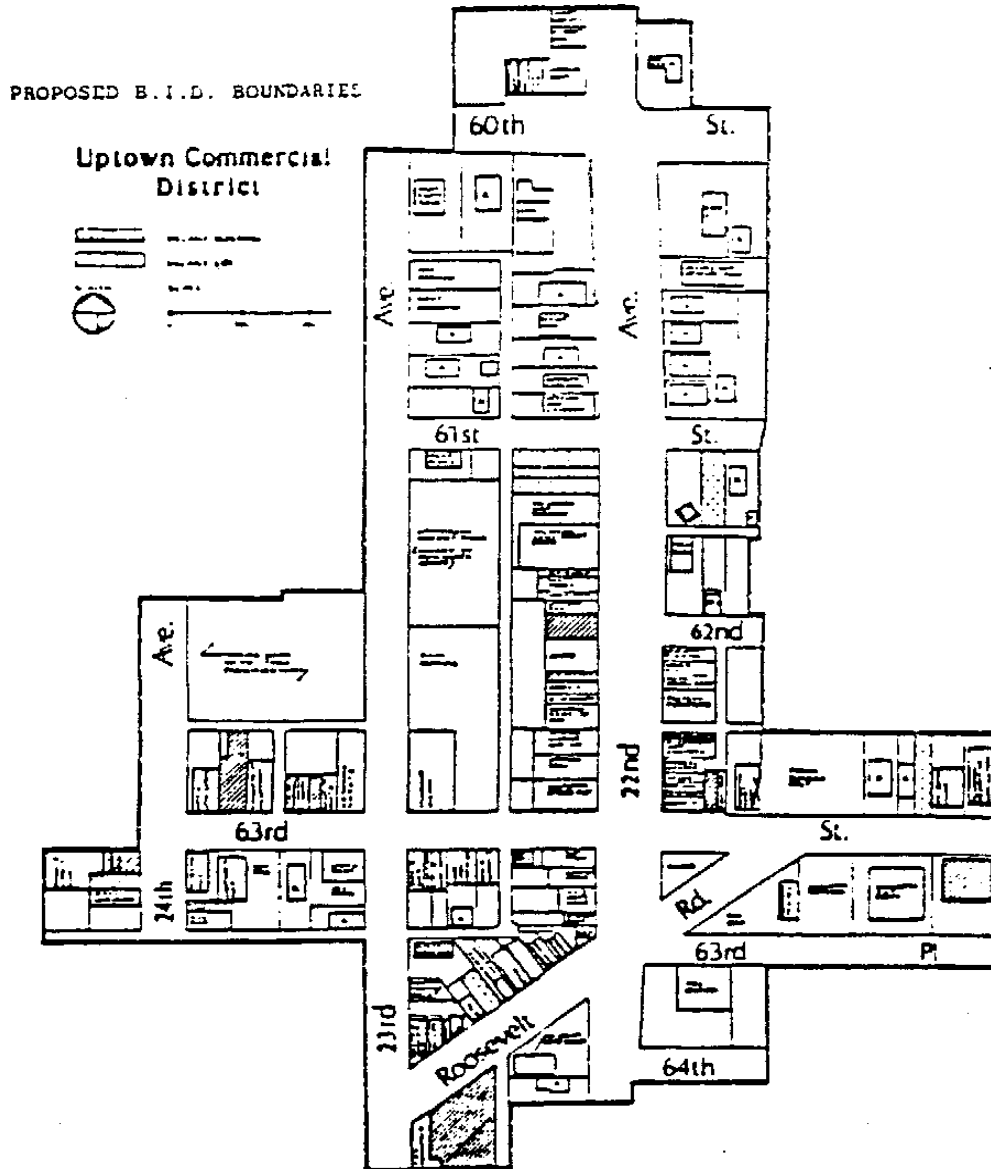

CHAPTER III
FIRE PREVENTION BUREAU

3.01 BUREAU OF FIRE PREVENTION

A. There is hereby created and established a Bureau of Fire Prevention, hereinafter referred to as the "Bureau", which shall be operated under the supervision of the Chief of the Fire Department.

B. Authority. The Chief of the Fire Department shall administer and enforce the provisions of this Chapter. The Chief shall have the authority and responsibility to:

1. Appoint a Chief of the Bureau.
2. Assign such other personnel of the Department to the Bureau as shall be necessary to enforce the regulations of this Chapter.
3. Recommend to the Common Council the employment of technical experts, who, when such authorization is made, shall be selected through examination by the Board of Police and Fire Commissioners to determine their fitness for the positions.

C. Enforcement.

1. It shall be the duty of the Chief and personnel of the Bureau to enforce the regulations of this Chapter and all other laws, lawful orders and ordinances relating to the following:

- a. The prevention of fires;
- b. The storage, sale, use and handling of combustibles and explosives, including fireworks;
- c. The installations and maintenance of fire alarm systems and fire protection equipment, appliances and devices;
- d. The maintenance of fire escapes as means of egress;
- e. The means, adequacy and maintenance of exit from all buildings, structures or other places in which numbers of persons live, sleep, work or congregate from time to time for any purpose;
- f. The investigation of the cause, origin, and circumstances of fires.

2. The Police Chief and police officers shall have the concurrent responsibility with the Chief of the Fire Department to enforce Section 3.18 of this Ordinance, entitled "Fireworks", and of this ordinance entitled "Control Of Open Burning; Open Flame In Buildings".

D. Reports. An annual report containing all information on matters regulated by this Chapter, together with statistics and such other information as may be required, shall be made and transmitted by the Bureau to the Chief of the Fire Department.

E. Duties of Bureau. The Bureau shall perform such other duties as are set forth in this Chapter, the Statutes of the State of Wisconsin, lawful orders of the Wisconsin Industrial Commission, the Ordinances and directives of the City of Kenosha, and all additional duties prescribed by the Chief of the Fire Department.

3.02 FIRE PREVENTION CODE

It is the intent of the Fire Prevention Code to prescribe regulations consistent with nationally recognized good practice for the safeguarding to a reasonable degree of life and property from the hazards of fire and explosion arising from the storage, handling, sale and use of hazardous substances, materials and devices, and from conditions hazardous to life or property in the use or occupancy of buildings or premises.

3.03 PROVISIONS OF CODE

A. Scope. This Chapter shall consist of the following:

1. The express provisions of the Fire Prevention Code as set forth herein;

2. All ordinances and lawful orders of the City of Kenosha, now or hereafter in effect, relating to fire prevention; the safeguarding of life and property from the hazards of fire and explosion; the handling, storage, sale and use of hazardous substances, materials and devices; conditions hazardous to life and property in the use of occupancy of buildings, structures or premises; and the safety of firemen in the performance of their duties;

3. All laws and lawful orders of the State of Wisconsin, hereinafter referred to as the State Code, relating to conditions as described in Paragraph 2., now or hereafter in effect; which provisions are hereby adopted and incorporated herein by reference;

4. Acts 1, 13, 25, 30, 58, 72 and 96 of the National Fire Code, 2006 Edition, and future amendments thereto as recommended by the National Fire Protection Association (hereinafter referred to as "NFPA (Section Number)") which provisions are hereby adopted and incorporated herein by reference, except the provisions thereof which may conflict with the provisions of the State Code or the express provisions of this Chapter. Not less than one (1) copy of these Codes and standards shall be on file and available at the Fire Prevention Bureau of the City of Kenosha Fire Department.

B. Conflict. Where the requirements of the State Code and the express provisions of this Chapter conflict, the stricter requirements shall govern.

Should any section, subsection, paragraph, sentence, clause, phrase or word of this Chapter be declared for any reason to be invalid or unconstitutional, the remainder of this Chapter shall not be affected thereby and shall continue in full force and effect.

All ordinances or parts of ordinances contravening the provisions of this Ordinance are hereby repealed.

3.04 RESPONSIBILITY

Except as otherwise specified herein, each owner, operator, manager, tenant, or holder of a Certificate of Occupancy shall be responsible for the maintenance of buildings, structures and premises within which they are associated.

3.05 DUTIES

A. Annual Fire Prevention Inspections. Except as otherwise provided in this Chapter, it shall be the duty of the Chief of the Fire Department to semi-annually inspect, or cause to be inspected by the Bureau or by officers and personnel of the Fire Department, all public buildings, structures and premises as defined by Wis. Stat. §101.01, for the purpose of ascertaining, and causing to be corrected, any conditions liable to cause fire, or any violations of any laws or lawful orders relating to conditions or circumstances defined in §3.01.

1. In the event a public building, structure or premises must be reinspected as a result of deficiencies identified in the annual fire prevention inspection, the property owner shall be charged a fee for the reinspection and subsequent reinspection(s), based upon a fee schedule adopted by Resolution of the Common Council from time to time which establishes the fees for the reinspections.

2. Reinspection fees shall constitute a special charge against the property under Wis. Stats. §66.0627, and shall be placed on the annual tax roll for collection as a special charge. All rules and regulations related to the collection of real estate taxes shall apply.

3. All buildings, structures and premises owned by the City of Kenosha, the State of Wisconsin, and the U.S. Government shall be exempt from this fee.

3.06 BUILDINGS, STRUCTURES AND PREMISES AFFECTED

A. Buildings, Structures and Premises Excepted. Except as otherwise specifically provided in this Chapter, the regulations contained herein on fire prevention and protection shall apply to all buildings, structures and premises, except:

1. Private residences, and accessory buildings or structures in connection therewith;
2. Buildings used as the residence of not more than two (2) families, and provided that no more than two (2) persons are accommodated therein who are not members of such families or households;
3. Temporary buildings or sheds used for construction purposes only.

B. Buildings, Structures and Premises Not Exempt. Subsection 3.06 A. notwithstanding, if any building, structure or premises is especially liable to fire; or is so situated as to endanger other buildings or property; or contains any combustible or explosive material dangerous to the safety of any building, structure or premises or the occupants thereof; or due to any physical condition that extraordinarily endangers or hinders firefighters in case of fire; then such building, structure or premises shall not be exempt.

3.07 AUTHORITY TO ENTER PREMISES

A. Right of Entry. The Chief of the Fire Department, the Bureau, any inspector of the Bureau or any authorized member of the Fire Department may, at all reasonable hours, enter any building or premises governed by this Fire Prevention Code for the purpose of making any inspection or investigation which, under the provisions of this Fire Prevention Code, is deemed necessary.

B. Failure to Permit Entry for Purposes of Inspection. Any person who refuses to permit, or prevents or interferes with any entry into or upon the premises by any such inspector, or interferes with any such inspection shall be deemed guilty of violating this Section and shall be punished as provided in this Chapter.

3.08 CLOSING AND VACATING OF BUILDINGS AND STRUCTURES

A. Enforcement of Code Compliance. The Chief of the Fire Department, or his/her designee, is hereby empowered to enforce compliance with the regulations of this Chapter and all other laws and lawful orders relating to fire prevention and fire protection in all buildings and structures governed by this Chapter.

B. Closure of Buildings or Structures. The Chief of the Fire Department, or his/her designee, is hereby empowered and directed to close any buildings or structure, and order it vacated, where violations of any regulations of this Chapter are found and not corrected within a reasonable period of time as stipulated by the Fire Chief or by the Bureau.

C. Emergency Closures of Buildings or Structures. Where the public is exposed to immediate danger, the Chief of the Fire Department, or his/her designee, is hereby empowered and directed to order the closing and vacating of the building, structure or premises at once.

3.09 NOTICES AND ORDERS

A. Service of Order(s). Whenever it may be necessary to serve an order upon the owner of a premises, such order may be served either by delivery to and leaving with the said person a copy of the said order, or if such person cannot be found, such order may be mailed to the owner's last known post office address.

B. Issuance of Order. If buildings, structures or other premises are owned by one person and occupied by another, under lease or otherwise, the orders issued in connection with the enforcing of this Fire Prevention Code shall apply to the owner and occupant thereof, except where the order requires the

making of additions or changes in the buildings, structures or premises themselves. In such cases the orders shall affect the owner only, unless it is otherwise agreed between the owner and the occupant.

C. Compliance With Order. Any such order shall be complied with by the owner and/or occupant of such building, structure or premises within the time prescribed in such order. The owner or occupant may, within five (5) days, appeal to the Chief of the Fire Department for a review of such order, who shall thereafter make the necessary investigation and decision. Unless such order is revoked or modified by the Chief of the Fire Department, it shall remain in force and be complied with within the time prescribed.

3.10 INVESTIGATION OF FIRES

A. Investigation. The Bureau, or any authorized officer of the Fire Department, shall investigate the cause, origin and circumstances of every fire occurring within the City which is of suspicious nature, or which involves loss of life or injury to person, or by which property has been destroyed or substantially damaged. Such investigation shall begin immediately upon the occurrence of such fire and, so far as possible, shall determine whether the fire is the result of accident, carelessness or design. If it appears to the Bureau, or the authorized officer of the Fire Department making the investigation, that the fire is of suspicious origin, the Chief of the Fire Department shall be immediately notified of such findings. Thereupon the Bureau, or the authorized officer, shall take charge immediately of the physical evidence, and shall notify the proper State authorities and/or Police Department, designated by law to pursue the investigation of such matters, and shall further cooperate with the authorities in the collection of evidence and in the prosecution of the case.

B. Report of Fire. Every fire shall be reported in writing to the Bureau within twenty-four (24) hours after the occurrence of the same, by the officer in charge at such fire. The report shall be in such form as shall be prescribed by the Chief of the Fire Department, and shall contain a statement of all facts relating to the cause, origin and circumstances of such fire, injury to person, extent of the damage to property, the insurance upon such property, and such other information as may be required.

C. Investigation of Fire of Suspicious Origin. The District Attorney and any department of the City may assist in the investigation of any fire upon request of the Chief of the Fire Department or the Bureau when, in their opinion, such fire is of suspicious origin.

3.11 FIRE DEPARTMENT EMERGENCY AMBULANCE AND RESCUE SERVICE

A. Emergency Ambulance And Rescue Service. The Kenosha Fire Department shall be responsible for providing Emergency Ambulance and Rescue Service to the public in the City and other municipalities covered by mutual aid agreements approved by the Common Council, which service shall include the administration of advanced life support pre-hospital emergency medical care.

B. Dispatching Operations. Public requests for City Fire Department provided Emergency Ambulance and Rescue Services shall be directed to the 911 Dispatcher operating under the jurisdiction of Kenosha City/County Joint Services.

C. Service Fees. Service charges for Emergency Ambulance and Rescue Services shall be as provided in §2.20 of the Code of General Ordinances. The City Fire and Finance Departments shall jointly administer billing and collection under said Ordinance.

D. Non-Application. This Ordinance does not apply to or regulate service provided by For-Profit Ambulance Service Providers.

3.12 FEES FOR VEHICULAR FIRE/HAZARDOUS MATERIALS SUPPRESSION SERVICES

A. Definition. "Vehicular Fire/Hazardous Materials Suppression Services" shall mean any service, other than emergency medical transport, provided by the City of Kenosha Fire Department in responding to the scene of a vehicular accident or disabled vehicle. Such services shall specifically include the prevention of fire, the suppression of fire, extraction of accident victims and the containment, handling and/or removal of hazardous materials, leaking fluids or accident debris.

B. Charges For Services. The City of Kenosha Fire Department shall charge a fee for providing Vehicular Fire/Hazardous Materials Suppression Services. The fee shall be computed so as to offset the cost of personnel, supplies and equipment used in providing these services and shall be billed to the person or persons receiving the services.

C. Fee Schedule. The Common Council shall, from time to time, by Resolution, establish fees for Vehicular Fire/Hazardous Materials Suppression Services.

D. Refusal To Provide Services. The City of Kenosha Fire Department shall not refuse or delay in the provision of any service to any person who has failed to pay for Vehicular Fire/Hazardous Materials Suppression Services when due.

3.13 FEES

A. Fees. The Common Council shall, from time to time, by Resolution, establish fees for the following Permits, reviews, inspections and services provided by the Fire Department, which, to the greatest extent possible, shall be collected prior to action by the Fire Department:

- Fireworks Sale
- Open Burning
- Fire Alarm Permit
- Fire Suppression Permit
- Hood System Permit
- Duct-Fire Extinguisher System Permit
- Aboveground Storage Tank/Underground Storage Tank Fees
- Reinspection Fees

B. Payment of Fees. A Permit shall not be valid until such time that the fees required by this Chapter have been paid.

C. Failure To Obtain Permit. When a Permit is required by this Ordinance and work is started prior to obtaining such Permit, the fees required shall be doubled. For the second offense within a twelve (12) month period, starting work prior to obtaining a Permit, the fee shall be quintupled. The payment of such doubled or quintupled fee shall not relieve any person from complying with the requirements of this Ordinance, nor from any penalties proscribed herein.

D. Failure To Pay Inspection Fees. When an Inspection Fee is required by this Ordinance and occupancy occurs prior to obtaining payment for such inspection fee, the fees required shall be doubled. For the second offense within a twelve (12) month period, and occupancy occurs prior to paying the Inspection Fee, the fee shall be quintupled. The payment of such doubled or quintupled fee shall not relieve any person from complying with the requirements of this Ordinance, nor from any penalties proscribed herein. As used herein, "Inspection Fee" includes fees for reinspection.

E. Reinspection Fees.

1. Reinspection Fees Assessed. A Reinspection Fee may be assessed on the owner, owner's agent or contractor responsible for the inspection request when any of the following occur:

- a.** An inspection is requested by the owner, owner's agent or contractor, and the Work is not completed prior to the commencement of the inspection.
- b.** An inspection is requested by the owner, owner's agent or contractor, and there is no access to the Premises.
- c.** After an initial inspection and notice of violation(s) to be corrected, an inspection is requested by the owner, owner's agent or contractor, to approve corrections, and those corrections are incomplete or only a portion of the corrections are made, or corrections have been ignored and previous arrangements have not been made with the Fire Chief to accomplish ordered corrections in phases.

2. Failure to Pay Reinspection Fee. Once a Reinspection Fee has been assessed, work may not proceed on the installation impacted, or occupancy may not occur until such time that said Reinspection Fee has been paid.

3. Final Inspection. There shall be no Reinspection Fee for a final inspection to determine compliance, or for a reinspection occurring during a period of an approved time extension granted for good cause and involving a good faith effort on the part of the property owner.

3.14 REVOCATION OF PERMIT(S)

The Bureau may revoke any permit or approval issued by the Bureau if any violation of this Chapter is found upon inspection or in case there has been any false statement or misrepresentation as to a material fact in the application or plans on which the permit or approval was based.

3.15 FIRE PREVENTION EDUCATION AND FIRE DRILLS

A. Fire Prevention Education in Schools. The person having direct charge of any public, private or parochial school or college shall at least once each month devote not less than one-half (1/2) hour to the teaching of fire prevention to the pupils.

B. Fire Drills in School Buildings. Fire drills shall be held at least once a month in school buildings, and shall include complete evacuation of all persons from the building. During severe weather, fire drills may be postponed.

C. Fire Drills in Other Institutions. Fire drills shall be held at least once every two (2) months in hospitals, mental and/or correctional institutions, homes for the aged, nursing homes, convalescent homes and children's homes, and shall be conducted to familiarize personnel with their assigned positions of emergency duty; complete evacuation of occupants from the building at the time of the fire drill shall be required only where it is practical and does not involve moving or disturbing persons under medical care.

D. Fire Drill Written Reports Required. A record of all fire drills shall be kept and persons in charge of such educational or institutional occupancies shall file written reports annually with the Bureau, giving the time and date of each drill held.

E. Violations. Every person who violates the provisions of this Section shall be deemed guilty of a separate offense for every thirty (30) days such violation shall continue, and shall be subject to a separate penalty for each and every offense.

3.16 FIRE EXTINGUISHING EQUIPMENT

A. Permit and Surety Bond. No person, company or representative of a company shall sell, service, repair or install portable fire extinguishers or appliances, warning devices, and/or sprinkling systems, that are to be used or displayed for use as fire protection devices in or upon any vehicle, structure or premises, or portions thereof, unless that person, company or representative shall file with the City of Kenosha a continuous surety bond of not less than Five Hundred Thousand (\$500,000.00) Dollars, which bond shall be approved by the City Attorney. Said bond shall be conditioned upon the performance of the permittee in accordance with the applicable sections of the Code of General Ordinances of the City of Kenosha.

B. Designation of Number, Type and Location of Fire Extinguishers. The Bureau is hereby empowered to designate the number, type and location of fire extinguishers and other fire protection equipment as may be deemed necessary in any building or structure.

C. Custodian of Fire Extinguishing Equipment in Places of Public Entertainment. The owner, agent or manager of every theater or place of public entertainment shall designate a person of competency, satisfactory to the Bureau, who, during every performance or public assemblage within such building or structure, shall be on duty to take charge of the fire extinguishing equipment required.

D. Fire Alarm, Detection and Extinguishing Systems.

1. Internal local fire alarm or detection systems shall be required in schools, public and private, colleges and universities, hospitals, institutions, jails, nursing, convalescent and retirement homes, and other occupancies with one hundred (100) or more sleeping accommodations or any building which has eight (8) or more separate residential occupancies. Said internal fire alarm or detection system in each of the aforesaid classes of buildings, except apartment houses, shall be connected to a private, twenty-four (24) hour supervised alarm company.

2. Every establishment preparing and serving food, except private residences, shall have automatic fire extinguishing protection built into any new or modified hood and/or exhaust system as part of any cooking equipment which has an open flame or an electric element that could cause ignition or contact with, or exposure to, grease or inflammable materials.

3.17 FALSE FIRE ALARM: DESTROYING, REMOVING, INJURING OR MEDDLING WITH FIRE ALARM SYSTEMS

A. False Fire Alarm; Destroying, Removing, Injuring or Meddling With Fire Alarm System Unlawful. It shall be unlawful for any person to give, or cause to be given a false fire alarm, with intent to deceive any public official or employee, or to tamper, meddle or interfere in any way with any fire alarm system or device, or any part thereof, or to make any connection therewith so as to interfere with the proper working of said system, or with intent to injure, break or destroy any machinery or fixtures connected with such system.

B. Violations.

1. Any person violating any provision of this Section shall, upon conviction of such violation, be punished by a forfeiture of not less than One Hundred (\$100.00) Dollars nor more than Five Hundred (\$500.00) Dollars, together with the costs of the prosecution, and in default of payment thereof shall be imprisoned until such forfeiture and cost are paid, but not to exceed sixty (60) days.

2. Any person violating any provision of this Section who has previously been convicted of violating this Section, and such prior conviction has not been reversed, shall upon conviction be required to forfeit not less than One Hundred (\$100) Dollars nor more than One Thousand (\$1,000.00) Dollars, together with the costs of the prosecution, and in default of payment thereof shall be imprisoned until such forfeiture and cost are paid, but not to exceed ninety (90) days.

3.18 FIREWORKS

A. State Law Incorporated And Made Stricter. Section 167.10, Wisconsin Statutes, is hereby adopted and incorporated herein by reference, and modified, as authorized by Subsection 5. thereof, to delete the fireworks described in Subsections l., m. and n. thereof, as permissible fireworks.

B. Permit For Sale Of Permissible Fireworks. No person, party, firm or corporation shall sell or offer for sale or hold or display for sale any permissible fireworks, as defined in §§167.10 (1) (e), (f), (i) (j), and (k), Wisconsin Statutes, without first having obtained a permit therefor from the Fire Chief, or designee, In the event of noncompliance with §167.10, Wisconsin Statutes, and/or this Ordinance, the Fire Chief, or designee may revoke or suspend said permit. Permit applications shall be made on forms provided by the City, and shall be fully completed prior to submission. The Fire Chief, or designee, may test samples of any device proposed to be included under said permit and may limit the permit by defining items determined by name brand and/or description to be permissible fireworks. The Fire Chief, or designee, may also test samples of any permittee which are offered, held or displayed for sale to determine permit compliance. Any and all contraband may be seized as evidence. Permits hereunder shall expire at the end of the calendar year in which issued.

3.19 CONTROL OF OPEN BURNING; OPEN FLAMES IN BUILDINGS

A. Definitions.

CODE OF GENERAL ORDINANCES, 2021 - KENOSHA, WISCONSIN

1. **"Bonfire"** shall mean a recreational fire that has a total fuel area greater than three (3) feet in diameter and greater than two (2) feet in height.

2. **"Cooking Fire"** shall mean a fire ignited and maintained for the express purpose of cooking food for human consumption.

3. **"Open Burning"** shall mean the oxidation from which the products of combustion are emitted directly into the ambient air without passing through a stack or chimney.

4. **"Outdoor Fireplaces or Fire Pits"** shall mean bowls or pits designed for the holding or burning of wood.

5. **"Recreational Fire"** shall mean an outdoor fire burning material other than rubbish with a total fuel area of three (3) feet or less in diameter and two (2) feet or less in height for pleasure, religious, ceremonial, warmth or similar purpose.

5. **"Sky Lantern"** shall mean a small hot air balloon made of paper, with an opening at the bottom where a small fire is suspended.

B. Prohibitions and Exceptions. Open burning and sky lanterns are prohibited with the following exceptions:

1. Small open flames for welding, acetylene torches, safety flares, heating tar or similar applications.

2. Outdoor fires for cooking, but only if said fire is contained in a device made of metal, concrete or brick, and specifically designed for the cooking of food by heat, steam or smoke; said device is to be located not closer than ten (10) feet to any building or structure. Once cooking is complete, the fire must be extinguished. Fires maintained contrary to this section are subject to an order to extinguish by the enforcement authorities at the sole discretion of the enforcement authorities in furtherance of this ordinance.

3. Bonfires, but only if a permit was first obtained from the Bureau and subject to the following conditions:

a. The applicant shall agree to indemnify, defend and hold harmless, the City of Kenosha, its officers, agents, and employees against any and all claims, liability, loss, charges, damages, costs, judgments, settlement expenses and attorney's fees, which any of them hereafter sustain, incur or be required to pay as a result of a permitted bonfire.

b. When required, the applicant shall furnish a certificate of insurance providing evidence of Commercial General Liability Coverage with minimum limits of one million dollars (\$1,000,000) per occurrence or a higher limit if determined to be necessary on a case-by-case basis. When required, such commercial general liability coverage shall include coverage for contractual liability and list the City of Kenosha, its officers, officials, employees and agents as additional insureds. The insurance policy shall contain a clause that in the event that the policy issued is cancelled for any reason, or any material charges are made therein, the Bureau will be notified, in writing, by the insurer at least thirty (30) days before any cancellation or change takes effect. The applicant shall provide the Certificate of Insurance described above at the time of submitting the bonfire permit application.

c. Applicant shall pay a nonrefundable permit fee of two hundred dollars (\$200.00), which will include three hours of event supervision by fire personnel. Events lasting longer than three (3) hours will be charged an additional fifty dollars (\$50.00) per hour for every portion of any hour thereafter.

d. The bonfire does not exceed eight (8) feet in diameter.

e. The height of the wood to start the bonfire does not exceed six (6) feet.

f. Only dry wood is permitted to be burned in bonfires. If trees are burned they may only have minimal branches, needles and leaves attached to them. No trash, yard waste, brush, flammable or combustible liquids or other materials may be burned.

g. May only be located at locations approved by the Bureau.

h. The smoke from the bonfire shall not create a nuisance.

i. The bonfire shall not be within fifty (50) feet of a building or lot line.

CODE OF GENERAL ORDINANCES, 2021 - KENOSHA, WISCONSIN

- j. The bonfire shall not be within fifty (50) feet or near combustibles such as trees, wooded areas, natural lawns, or brush. Except if the lawn is mowed and is less than six (6) inches high.
- k. Other than when igniting or extinguishing the bonfire, individuals are not permitted to be within eight (8) feet of the bonfire.
- l. The bonfire must be supervised at all times by a responsible adult. The bonfire must be completely extinguished, including all embers, before it is left unsupervised.
- m. The bonfire shall not be ignited or maintained when air quality is other than good or moderate as defined by the Wisconsin Department of Natural Resources.
- n. Bonfires shall be subject to any other conditions as determined by the Bureau when considering any issues of fire safety, public safety and welfare.

4. Fires set for practice and instruction of firefighters, or testing of firefighting equipment.

5. Recreational Fires contained within outdoor fireplaces or fire pits subject to the following conditions:

- a. Permission of the property owner is required before starting a fire.
- b. Fireplaces shall include a bowl with supports to ensure clearances to combustibles.
- c. Fire pits shall have an enclosure, heavy screen or spark arrestor to control and contain embers and sparks.
- d. Fireplaces or fire pits shall not be used within fifteen (15) feet of a building or lot line.
- e. Fireplaces or fire pits shall be used on a stable level surface.
- f. Fireplaces or fire pits shall not be used on any combustible deck, porch, or patio.
- g. Only clean, dry wood is permitted to be burned in fireplaces or fire pits. No trash, yard waste, or construction materials shall be burned.
- h. If the fireplace is a propane unit only propane shall be burned.
- i. The smoke from the fireplace or fire pit shall not create a nuisance.
- j. A fire extinguisher, garden hose, or other method of fire control shall be readily available.
- k. The fireplace or fire pit must be supervised at all times by a responsible adult. The fire must be completely extinguished before the fireplace or fire pit is left unsupervised.
- l. Fireplaces or fire pits shall not be operated when air quality is other than good or moderate as defined by the Wisconsin Department of Natural Resources.
- m. Manufactured outdoor fireplaces and fire pits shall be operated in accordance with the manufacturer's assembly, safety, and operating instructions.
- n. Fireplaces and fire pits cannot be ignited before 4:00 p.m. and must be extinguished by 10:00 p.m. Fireplaces as described in paragraph B.5.h. are exempt from time restriction.
- o. Fireplaces and fire pits shall be subject to an order to extinguish by the enforcement authorities at the sole discretion of the enforcement authorities in furtherance of this ordinance.
- p. No recreational fires are allowed when wind speeds exceed 15 mph.

C. Open Burning Procedures. All allowed open burning shall be conducted in conformance with State fire protection regulations and this Ordinance, and shall not endanger the public health, safety or welfare or be an annoyance or discomfort to the neighborhood or traveling public.

D. Open Flame in Building. No open flame candle or other open flame fixture shall be used in any building or structure unless guarded and attended by an adult; however, no open flame fixture shall be used in any tent or temporary structure.

E. Penalties. Any person violating any provision of this section shall be punished, upon conviction, by a forfeiture of not less than One Hundred Dollars (\$100.00), not more than One Thousand Dollars (\$1,000.00), together with costs of the prosecution, and in default of payment thereof shall be imprisoned until such forfeiture and costs are paid, but not to exceed sixty (60) days.

F. The Fire Chief will provide the Public Safety and Welfare Committee a review of the Fire Safety Ordinance by September 1, 2018.

3.20 HAZARDOUS MATERIALS

No person employed in any public building shall place or store used smoking materials in a combustible receptacle. Every receptacle used for disposing of used smoking materials shall be of noncombustible material and have a spring-loaded or self closing lid or cover or be constructed in such a manner so as to be a self extinguished receptacle. There shall be no less than one approved receptacle in every service area where used smoking materials are gathered for disposal.

Public/commercial establishments preparing and serving food for public consumption, shall clean, or have cleaned, all cooking equipment at least once each six months and, more often if necessary, as determined by the Bureau in order to prevent fire in exhaust ducts, hoods, fans, filters and exposed surfaces in the immediate area of the food preparation unit.

3.21 MAINTENANCE AND STORAGE OF COMBUSTIBLE MATERIALS

A. Oily Waste and Rags.

1. Oily waste and oily rags, when not in actual use, shall be kept in approved, standard, self-closing metal waste cans, set firmly on three inch legs.

2. One such waste can shall be installed for every two thousand five hundred (2,500) square feet, or fraction thereof, on each floor where oily waste or oily rags are used or collected.

3. The contents of all such waste cans shall be properly disposed of at least once daily.

B. Oil Drip Pans and Cups.

1. Metal drip pans shall be placed under all oil barrels and drums resting on wooden floors, platforms or supports, and under all machines using oil, to catch the oil drippings, and oily metal borings and shavings. The contents of such drip pans shall be properly disposed of at least daily.

2. Metal drip cups shall be placed under all shaft bearings, including elevator machinery, suspended from the ceiling.

C. Oil-Bearing Machines. When a printing press or other oil-bearing machine is placed on a combustible floor, such floor shall be protected with substantial sheet metal or other approved noncombustible material, as directed by the Bureau.

D. Oily Clothing. Oily or greasy clothing shall not be allowed to remain on wooden floors or workbenches, nor placed in wooden lockers, nor hung against combustible walls or partitions. Approved ventilated metal lockers or metal-lined wooden lockers shall be provided.

E. Floors. All combustible floors and platforms shall be kept free of oil drippings and oily waste and rags.

F. Waste Materials.

1. No owner, agent or occupant of any building within the City shall allow to accumulate any Waste Materials such as paper, hay, straw, rags or other waste material of a combustible nature in any building or on any premises unless stored as provided in Subsection 3.21.

2. The Fire Chief or his/her designee shall order the immediate removal of such accumulated combustible waste material from any building or premises when, in his/her opinion, such storage would create a fire hazard. Ashes, when kept in basements of buildings under this Section, shall be placed in fireproof bins, areas or containers.

3. Waste Material shall be stored in a separate fireproof storage building, in a metal container with a cover, metal lined box with cover, or a fireproof vault or room. Waste Material so stored shall be properly disposed of at least daily.

G. Decorative Materials.

1. For all occupancies in Groups A and E (as defined in the International Building Code), no decorative materials such as flammable window draperies, curtains, streamers, surface coverings applied over the building interior finish for decorative, acoustical or other effect, and cloth, cotton batting, straw vines, leaves, trees, and plastics used for decorative effect are permitted, except for floor coverings and ordinary window shades.

2. The Fire Prevention Bureau shall have the authority to permit the use of decorative materials, provided that the materials have been effectively treated with an approved fire retardant and are maintained as flameproof. Proof of treatment must be provided to the Bureau.

3.22 EXPLOSIVES

A. Wisconsin Administrative Code. Except as herein provided, the General Orders on Explosives COMM 7 of the Wisconsin Administrative Code, shall apply to the storage, use, handling and transportation of explosives within the corporate limits of the City of Kenosha; the said Orders are hereby adopted and incorporated herein by reference.

B. Permits.

1. No person shall transport, store, sell, deliver, use or have in possession any explosive without first obtaining a permit therefor from the City Clerk/Treasurer and approved by the Bureau.

2. Any person desiring a permit as required by this Section shall file with the Bureau an application for such permit, in writing, upon a form furnished for such purpose. Every application shall state the name or names of the applicant(s), stating further the location and manner of storage or sale, or the location where blasting is to be done, the method of detonating the explosive, and any other information as may be required by the Bureau.

3. Permits for the storage or use of any explosive, when issued, shall, at all times, be kept on the premises in a readily accessible place for inspection.

4. No permit for blasting shall be issued for a period longer than forty-eight (48) hours.

C. Revocation of Permit. If, after a permit has been granted, an inspection by the Chief of the Fire Department or an Inspector of the Bureau discloses that the permit holder, or those acting under him, or those attempting to store or use such explosives are operating contrary to the regulations of this Section, the Chief of the Fire Department, the Chief of the Bureau, or an Inspector of the Bureau shall immediately stop all operations and revoke the permit. When such operations are stopped and the permit is revoked, all explosives shall immediately be removed from the premises and the City, subject to the regulations of this Section relative to transportation of explosives.

D. Limiting Amount of Explosive. In all cases involving the use of any amount of explosive, the Bureau may refuse a permit, as required by Subsection B. of this Section, if in its judgment, the use of explosives is likely to endanger or cause damage to life, health or property; or the Bureau may limit the use of such explosive to twenty-five (25) pounds if it deems a greater amount of such explosive to be unreasonably dangerous.

E. Delivery in Transit.

1. No person conveying explosives of any kind or nature by means of a boat, vessel, railroad car, wagon, automobile or any other means of conveyance shall enter the City, under any circumstances, without first reporting to the Bureau. The Bureau may permit such conveyance to enter and remain in the City for a specified period of time. Should such time exceed five (5) hours, a permit shall be procured from the Bureau.

2. Except in case of emergency, as determined by the Bureau, all explosives shall be transported through the streets of the City between the hours of midnight and six (6:00 A.M.) o'clock in the morning; and not more than five hundred (500) pounds shall be transported at one time. The Chief of the Fire Department or the Bureau may designate the route to be traveled.

F. Exceptions. Nothing contained in this Section shall be construed as applying to the regular military or naval forces of the United States, or the militia of any State thereof, nor the Police or Fire Department provided they are acting within their official capacity and in the performance of their duties.

G. Location of Magazines.

1. The location of all magazines in which explosives are to be kept or stored shall be approved by the Bureau.

2. The area surrounding a magazine for a distance of at least twenty-five (25') feet shall be kept free from rubbish, weeds, shrubbery, dead grass and other combustible materials.

H. Record of Blasting and Use of Explosives. Every person using explosives or responsible for the use thereof shall keep a "Blasting Record", which shall show the date of blasting, time, location of shot or shots, number of holes for explosive, depth of holes, amount of explosive used, by stick if dynamite, and by pounds or other applicable measurement if other explosives are used.

I. Penalties.

1. Any person violating any provision of this Section shall be punished, upon conviction, by a forfeiture of not less than One Hundred (\$100.00) Dollars, nor more than One Thousand (\$1,000.00) Dollars, together with the costs of the prosecution, and in default of payment thereof shall be imprisoned until such forfeiture and cost are paid, but not to exceed sixty (60) days.

2. Any person violating any provision of this Section who has previously been convicted of violating any provision of this Section and such prior conviction has not been reversed, shall, upon conviction, be required to forfeit not less than One Hundred (\$100.00) Dollars, nor more than One Thousand (\$1,000.00) Dollars, together with the costs of the prosecution, for each offense, and in default of payment thereof shall be imprisoned until such forfeiture and cost are paid, but not to exceed ninety (90) days for each offense.

3.23 AUTOMATIC FIRE SPRINKLER SYSTEMS

A. Purpose. The purpose of this Section is to provide the means for the automatic extinguishment of fire in buildings or parts of buildings which, because of their size, construction or occupancy, or lack of suitable protective equipment, constitute a special fire hazard to life or property, or an excessive burden upon the fire extinguishing capabilities of the Fire Department.

B. Definitions. The following words, terms and phrases, when used in this Chapter, shall have the meanings ascribed to them in this Section, except where the context clearly indicates a different meaning.

1. "**Area**" means ground area of buildings or sections of buildings divided by an approved firewall, each section being considered a separate area.

2. "**Automatic Fire Sprinkler Equipment**" means an integrated system of underground and overhead piping designed in accordance with fire engineering standards. The system includes a suitable water supply, such as a gravity tank, fire pump, reservoir or pressure tank and/or connection by underground piping to a municipal water main. The portion of the sprinkler system aboveground is a network of specially sized or hydraulically designed piping installed in a building, structure or area, generally overhead, and to which sprinklers are connected in a systematic pattern. The system includes a controlling valve and a device for actuating an alarm when the system is in operation. The system is usually actuated by heat from a fire and discharges water over the fire area.

3. "**Basement**" means any story where less than half of the height between the floor and ceiling is above the average level of the street, sidewalk or finished grade.

4. "**Fire Resistive**" means that type of construction in which the structure members, including walls, partitions, columns, floors and roof construction are of noncombustible materials with a fire resistant rating of not less than those specified in Chapter 7 of the International Building Code.

5. "**Story**" means that part of a building comprised between a floor and the floor next above it, or if there is no floor above it, then the space between the floor and the ceiling above it.

C. Wisconsin Administrative Code. The provisions of the Wisconsin Administrative Code regulating Automatic Fire Sprinkler Systems and Fire Safety are hereby adopted and incorporated herein by reference as it now exists and as it may be amended in the future.

D. Installation and Maintenance Required.

1. **Requirement.** Every building constructed, structurally altered, or has a change of occupancy, where required, shall have an approved Automatic Fire Sprinkler System installed and maintained when occupied, in whole or in part, for the following purposes in the following building groups (which building groups are defined in the International Building Code):

a. Assembly Group A.

(1) Assembly Group A buildings which accommodate less than one hundred (100) people shall have an approved sprinkler system installed and maintained if they meet any one (1) or more of the following:

(a) Building of IA construction of over three thousand five hundred (3,500) square feet or more in area on any floor.

(b) Throughout all buildings of other than IA construction if:

i. Over two thousand five hundred (2,500) square feet in area; or,

ii. Over two (2) stories in height, regardless of area.

(2) Assembly Group A buildings that can accommodate one hundred (100) or more people shall have an approved sprinkler system installed and maintained throughout.

b. Business Group B and Mercantile Group M. An approved sprinkler system shall be installed and maintained in Business Group B and Mercantile Group M buildings which meet one (1) or more of the following:

(1) Buildings of IA construction of over three thousand five hundred (3,500) square feet or more in area on any floor.

(2) Throughout all buildings of other than IA construction if:

(a) Over four thousand (4,000) square feet in area; or,

(b) Over two (2) stories in height, regardless of area.

c. Educational Group E. An approved sprinkler system shall be installed and maintained throughout all educational occupancies and any type of daycare setting, except in-home daycare.

d. Factory and Industrial Group F and Storage Group S. An approved sprinkler system shall be installed and maintained in buildings that meet one (1) or more of the following:

(1) Buildings of Type IA construction if they are:

(a) Over five thousand (5,000) square feet in area.

(b) Over one (1) story in height, exceeding five thousand (5,000) square feet in area.

(c) Over two (2) stories in height, regardless of area.

(2) Throughout all buildings of other than IA construction if:

(a) Over five thousand (5,000) square feet in area.

(b) Two (2) stories or more in height, regardless of area.

e. High Hazard Group H. An approved sprinkler system shall be installed and maintained throughout all Group H occupancies.

f. Institutional Group I and Residential Group R-4. An approved sprinkler system shall be installed and maintained throughout all Group I and Group R-4 Occupancies.

g. Residential Groups. Residential Group R-2 and R-3 occupancies shall have an approved sprinkler system installed and maintained if it meets any one (1) or more of the following:

(1) Buildings of Type IA construction if they are:

(a) Over five thousand (5,000) square feet in area.

(b) Over one (1) story in height, exceeding five thousand (5,000) square feet in area.

(c) Over two (2) stories in height, regardless of area.

(2) Throughout all buildings of other than IA construction if:

(a) Over four thousand (4,000) square feet in area on a floor.

(b) More than two (2) stories in height.

h. Utility and Miscellaneous Group U. Group U covers all buildings and structures not covered in any other occupancy classification. Sprinkler system requirements for Group U buildings and structures will be reviewed by the Fire Chief on a case-by-case basis.

2. Exception to the Installation Requirement. Unless otherwise required by state law, any building that has a U.L. - approved smoke detection system that includes a monitored, central-station fire alarm panel, which system has been approved by the Fire Chief for the building in which it is installed, that completely satisfies any of the following is excepted from the installation requirement of paragraph D. 1.

a. An existing building.

b. A building that is constructed pursuant to a developer's agreement approved by the Common Council before the effective date of this ordinance and is first occupied no later than July 1, 2013.

The exception of this paragraph D.2 does not apply to the maintenance requirement for a sprinkler system that is already installed.

3. Automatic Fire Sprinkler Systems Plan Submittal Requirement. Plans and specifications shall accompany each submittal, including all applicable plan review and acceptance testing fees. Plans will be reviewed and conditionally approved by the Fire Prevention Bureau. All sprinkler systems require a permit issued by the Department of City Inspections prior to the start of any work. The Kenosha Fire Department shall witness all field and acceptance testing.

E. Exceptions. Provided that an alternate fire suppression system approved by the Bureau is in use, any portion of a building housing a process or material which would interact with water to create a greater fire hazard than without water, may be exempt from the requirement of Automatic Fire Sprinkler System.

F. Water Supply System. The water service line providing water to an Automatic Fire Sprinkler System may be connected to the general water service lateral, or may be a separate lateral, providing however, that if connected to the general water service lateral, the line must be separated and valved before the water meter which measures the domestic water supply.

The size, location and metering of the required water supply line must be authorized and approved by the Kenosha Water Utility in accordance with the Rules and Regulations governing water service in the City of Kenosha.

The owner of any premise requiring Automatic Fire Sprinkler Service is required to pay for the full cost of installing a new or separate fire service water supply line in addition to all necessary valves, fittings and meter settings required to provide such service; and shall further be required to sign a contract for a water supply line service connection with the City of Kenosha Water Utility.

G. Fire Department Connections.

1. Requirements. Every Automatic Fire Sprinkler System shall have the following:

a. A Concrete Pumper Pad. The concrete pumper pad shall have the following minimum dimensions of concrete: length of twenty (20') feet; width of fifteen (15') feet; and depth of six (6") inches. The concrete pad must be designed and maintained to allow for the parking of at least a Fire Department pumper apparatus of sixty-five thousand (65,000 lbs.) pounds gross weight on it, without failure. Said pumper pad must have included within it or have within five (5') feet adjacent to it, a fire hydrant containing at least one four and one-half (4.5") inch outlet with Kenosha standard threads and at least two (2) two and one-half (2.5") inch outlets having national standard threads; if the fire hydrant is located off the concrete pumper pad, the concrete pumper pad must be oriented such that an outlet having the Kenosha standard threads must face the concrete pumper pad, and there may not be any obstruction between the fire hydrant and the pumper pad that would impede a firefighter's access to the fire hydrant from the pumper pad, or that would inhibit the operation of a hose extending from the fire hydrant to the Fire Department pumper apparatus.

b. A Fire Department Connection. The Fire Department Connection shall be operationally connected to the Automatic Fire Sprinkler System. The Fire Department Connection shall have a Siamese connection with two and one-half (2.5") inch national standard threads, and a five (5") inch Storz connection. The Fire Department Connection shall be located to comply with all of the following: no further than five (5') feet from the pumper pad; no further than five (5') feet from a fire hydrant; and no closer to the building it services than the height of the building that it services. There may not be any obstruction

between the fire hydrant and the Fire Department Connection that would impede a firefighter's access to the Fire Department Connection, or that would inhibit the operation of a hose extending from the fire hydrant to the Fire Department Connection. There may not be any obstruction between the pumper pad and the Fire Department Connection that would impede a firefighter's access to the Fire Department Connection, or that would inhibit the operation of a hose extending from the pumper pad to the Fire Department Connection.

c. Locking Cap Covers. All Fire Department Connections, regardless of when installed, shall be occluded by a Locking Cap capable of being removed by appropriate Key Wrenches carried by the Fire Department. Due to the need for consistency and efficiency in emergency situations, and due to the proprietary nature of Key Wrenches, the Fire Department may specify a certain manufacturer or a limited number of manufacturers that provide Locking Caps removable by a particular Key Wrench configuration.

d. Bollards. Fire hydrants associated with the pumper pad shall be protected from vehicular traffic damage with bollards. The Bureau shall determine the number of bollards needed.

e. Signage. All Fire Department Connections will be labeled on the building or pumper pad; signage to be approved by the Bureau.

2. Exceptions. Any or all of the requirements of this Subsection 3.23 G. may be waived by the Fire Chief in the exercise of his/her discretion, subject to the considerations of public safety and welfare, if either of the following apply:

a. The construction, alteration, or change requiring installation of an Automatic Fire Sprinkler System pursuant to Subsection D., herein, creates occupiable space of less than ten thousand (10,000) square feet; or,

b. The construction, alteration, or change requiring installation of an Automatic Fire Sprinkler System pursuant to Subsection D., herein, is in sufficiently close proximity to a suitable paved surface, including, but not limited to, a street, and a hydrant to enable the Department to effectively charge an Automatic Fire Sprinkler System from a pumper located on the paved surface.

H. Yard Fire Hydrants As A Part of Fire Loop.

1. Number of Required Yard Fire Hydrants. Additional yard fire hydrants shall be provided around the perimeter of the building so that no yard fire hydrant is more than five hundred (500') feet from other approved yard fire hydrants measured by normal access routes.

2. Setback Distances. Yard fire hydrants shall be no more than five (5') feet from the curb or edge of the street or fire apparatus access. Alternative setback distances may be considered when site conditions conflict with the provisions of this Section.

3. System Design.

a. Valves. Control valves shall be provided to limit the number of yard fire hydrants and/or Automatic Fire Sprinkler Systems affected by maintenance, repair or construction. Valves shall be located at street intersections and at no more than eight hundred (800) foot intervals, and sectional control valves shall be placed so that no more than a combination of yard fire hydrants and Automatic Fire Sprinkler Systems can be isolated between control valves. Valves shall be provided in each yard fire hydrant lead.

b. Outlet Position. All yard fire hydrants shall be positioned so that the largest outlet faces the street or fire apparatus access route.

c. Yard Fire Hydrant Height Above Grade. The center of the lowest outlet cap of the yard fire hydrants shall be at least eighteen (18") inches above grade and not more than twenty-three (23") inches above grade.

4. Yard Fire Hydrant Specifications. All yard fire hydrants shall meet the specifications of the Kenosha Water Utility.

5. Bollards. Yard fire hydrants shall be protected from vehicular traffic damage with bollards. The Bureau shall determine the number of bollards needed.

6. Yard Fire Hydrant Colors.

a. Yard fire hydrants fed by municipal water shall be red in color.

b. Yard fire hydrants fed by a fire pump shall be painted a solid yellow color, both barrel and caps.

c. No person shall alter the color or paint scheme of an approved private fire hydrant. That person or persons who alter the color of a fire hydrant identified above shall be in violation of this Chapter.

I. Installation Standards.

1. NFPA Standards. Approved Automatic Fire Sprinkler System equipment shall be installed in accordance with one (1) or more of the following NFPA standards as the Fire Chief may determine are applicable:

- a. NFPA #13, Standards for the Installation of Sprinkler Systems.
- b. NFPA #13D, Sprinkler Systems - One and Two-Family Dwellings.
- c. NFPA #13R, Sprinkler Systems in Residential Occupancies Up To and Including Four Stories in Height.
- d. NFPA #231, General Storage.
- e. Such other NFPA standards as the Fire Chief may determine are applicable.

2. Plans/Specifications Approval. No Automatic Fire Sprinkler System equipment shall be installed or altered in a building until plans have been submitted to and approved by the Chief of the Bureau of Fire Prevention. Three (3) copies of the plans and specifications shall be submitted for review. Approved plans shall be stamped "Approved By Bureau of Fire Prevention", together with the date of such approval.

3. Outdoor Rated Horn/Strobe Notifier. An outdoor rated horn/strobe notifier with an excess of 100 candle power shall be installed in lieu of the required bell. The normal placement is above the Fire Department connection, but shall be approved by the Fire Chief.

4. Water Flow Monitoring. All Automatic Fire Sprinkler Systems shall be monitored for water flow by a central or remote station pursuant to the current version of NFPA 72.

5. Underground Water Mains, Hydrants and Valves. Underground water mains, hydrants and valves shall conform to the current specifications of the City.

6. Testing. The Kenosha Water Utility will require such tests as may be required by applicable NFPA standards. Such tests shall be conducted under the supervision of a water utility representative who shall certify acceptance or rejection of the system.

7. Final Approval/Acceptance Test - Automatic Fire Sprinkler System.

- a. The Automatic Fire Sprinkler System shall have a hydrostatic test performed in the presence of a Fire Department Inspector.
- b. The Automatic Fire Sprinkler System shall be tested by flows of the main drain and Inspector's test. The installer, in the presence of a Fire Department Inspector, shall conduct the acceptance test.
- c. The installer shall provide a minimum of three (3) working days advanced notice to the Fire Department prior to performance of the final acceptance test.
- d. Any work or testing performed on sprinklers and underground supply shall be done by a duly licensed individual.

8. Maintenance. The owner or occupant of a building or structure containing a required Automatic Fire Sprinkler System shall maintain the system in an operative condition at all times. The owner or occupant of the building shall properly notify the Fire Chief, or designee thereof, in case such sprinkler protection becomes inoperative due to a breakdown. An Automatic Fire Sprinkler System may not be rendered inoperable, even for servicing, without the written permission of the Fire Chief, or designee, and then only for the duration of the time permitted. No such system, once installed for any reason shall be disconnected or shall cease to be maintained, should a building or structure cease to be occupied, in whole or in part, without first obtaining a permit to do so from the Fire Chief, or designee. Such permit shall not be issued if the building would become an unreasonable fire risk or burden upon the City's firefighting resources, if unprotected. All Automatic Fire Sprinkler Systems shall be tested annually to meet the requirement of NFPA 25. A person(s) or company holding a testers' credential issued by the State of Wisconsin shall perform the tests.

J. Certification - Inspection/Occupancy. Every installer of an Automatic Fire Sprinkler System shall, upon completion, certify to the Fire Chief, or designee thereof, that installation was completed pursuant to the requirements of this Ordinance. Upon receipt thereof, the Fire Chief or designee, will inspect said installation and verify compliance or direct such appropriate action as required to secure compliance. No building or structure for which an Automatic Fire Sprinkler System is required shall be occupied or used for its intended purpose until compliance with this Ordinance is verified by the Fire Chief or designee. The Director of City Inspections shall not issue a Certificate of Occupancy for any building or structure until compliance with this Ordinance, where required, is verified.

K. Penalty. Any person or party violating any provision of this Ordinance shall, upon conviction, forfeit a sum not less than One Hundred (\$100.00) Dollars nor more than One Thousand (\$1,000.00) Dollars, plus costs and assessments required by law. Each day of violation shall be a separate offense.

3.24 FIRE DEPARTMENT STANDPIPES

A. Class Three Standpipe. A Class Three Standpipe will be installed in all buildings meeting one (1) or more of the following:

1. Any building of three (3) stories or more.
2. Any building having occupancy of one hundred (100) or more.
3. Any building with one floor of seven thousand five hundred (7,500) square feet or more in area.
4. Any building over one story in height and six thousand (6,000) square feet or more in area on a floor.

B. Approved Devices/Materials. All devices and materials used in standpipe systems shall be of approved type.

C. Other Standards and Specifications. All other standards and specifications will be taken from the current edition of NFPA Pamphlet #14, "Standards for the Installation of Standpipe and Hose Systems". The installation of a Automatic Fire Sprinkler System will not supersede the requirements for the installation of Fire Department standpipes.

D. Parking Structures. Any parking structure built whether aboveground or below ground will have a standpipe system approved by the Bureau prior to installation.

3.25 FIRE ALARMS

A. General. "Fire Alarm Systems" shall mean any device designed to sense or alert persons to the possible presence of fire. A Fire Alarm System may include, but is not limited to, smoke alarms, heat alarms, pullboxes, horns, and strobes and alarm panels. All Fire Alarm Systems shall be installed per NFPA 72. All required alarm systems (required per NFPA 101 or the orders of the Kenosha Fire Department) shall be monitored by an Underwriters' Laboratory listed monitoring company. All Fire Alarm Systems require plan submittal. Plans and specifications shall accompany each submittal, including all applicable plan review and acceptance testing fees. Plans will be reviewed and conditionally approved by the Fire Prevention Bureau. All Fire Alarm Systems require a permit issued by the Department of City Inspections prior to the start of any work. The Kenosha Fire Department shall witness all field and acceptance testing.

B. Maintenance. The owner or occupant of a building or structure containing any Fire Alarm System shall maintain that system in an operative condition at all times, which shall include periods where the building may not be occupied. The occupant of the building shall notify the Fire Chief immediately in case the Fire Alarm System is rendered out of service for any reason. All Fire Alarm Systems shall be tested to meet the requirement of NFPA 72. A person(s) or company holding tester credentials issued by the State of Wisconsin shall perform the tests.

3.26 FIRE PROTECTION SYSTEMS

A. Application For Permit, Plans and Specifications.

1. General. No person may install, erect or construct any Fire Alarm System or Fire Suppression System, or add to, enlarge, move, improve, alter, convert, extend or demolish any existing Fire Alarm System or Fire Suppression System, or cause the same to be done, or commence any work covered by this Code on any Fire Alarm System or Fire Suppression System without first obtaining a Fire Alarm/Fire Suppression System Permit therefor from the Bureau. Such permit shall be issued in the name of the owner.

2. Applications For Fire Alarm/Fire Suppression System Permits. Applications for Fire Alarm/Fire Suppression System Permits shall be filed with the Bureau in writing on a form to be furnished for that purpose. Such application shall describe the property and/or structure upon which the proposed system is to be installed or work done, either by street number, lot, or similar general description which will readily identify and locate the site of the proposed installation or work, and shall show the use or occupancy of all parts of the building and such other pertinent information as may be required by the Bureau.

The Bureau Chief or any Inspector of the Fire Department shall, as a condition of granting a Fire Alarm/Fire Suppression System Permit, have the right to enter the premises for which said permit was issued, at any reasonable time during and throughout the course of such work and until final approval thereof has been granted, for the purpose of inspecting said premises and the installation, modification, construction, repair, use and location of Fire Alarm/Fire Suppression Systems.

3. Plans and Specifications. Working plans and specifications showing the location of each component element of the proposed Fire Alarm System and/or Fire Suppression System, all drawings, manufacturers' cut sheets for devices, calculations, material approvals, manufacturers' listed installation and design manuals, pre-engineered design specifications, design specifications, and the manufacturer, model and type of each component element of such systems, shall accompany every application for a permit, and shall be filed in triplicate with the Bureau; provided, however, that the Bureau may authorize the issuance of a permit without plans or specifications for minor or inconsequential work.

a. Plans submitted shall be drawn to scale on substantial paper. The submitted plans shall be working plans of sufficient clarity to indicate the nature and character of the work proposed and to show compliance with applicable regulations. Plans shall be prepared in accordance with the provisions of this Code, and shall bear the name of the architect, professional engineer, contractor or other person who prepared them.

b. Specifications shall be in detail. Any specifications in which general expressions are used to the effect that "work shall be done in accordance with the Fire Code" or "to the satisfaction of the Bureau" shall be deemed incomplete. Every reference to the Fire Code shall be to the section or subsection applicable to the material to be used or to the method of construction proposed.

c. Alterations to and/or modifications of an existing Fire Alarm System and/or Fire Suppression System may not, at the discretion of the Bureau, require a complete set of plans as set forth above; however, each such application for a permit shall include appropriate supporting documentation establishing that the proposed alterations/modifications comply with all appropriate Codes, Ordinances and standards.

B. Fire Alarm/Suppression System Permit.

1. Definition. The term "approved" as used in this Chapter shall mean approval granted by the Chief of the Fire Department or the Bureau under the regulations of this Chapter.

2. Plan Submission and Approval. When plans are required for approval, they shall be submitted in triplicate and work shall not be started until plans are approved, except by special permission to start work as issued by the Bureau. The plans submitted shall be working plans that are clear, legible and permanent. If the application, plans and specifications are in conformity with the requirements of this Code and all other laws or Ordinances applicable thereto, the Bureau shall, upon receipt of the required fee, grant a Fire Alarm/Suppression System Permit for said work and shall sign, date and endorse in writing or by rubber stamp all sets of submitted plans as "approved"; or, if approval is conditioned upon changes to the plan or compliance with other conditions, the plans may be stamped as "conditionally approved". In all such cases where plans are "conditionally approved", the Bureau shall return, with the approved plans, written notification of the conditions that must be satisfied. Whenever a submitted application is incomplete, the Bureau may suspend any action on such application and shall notify the applicant of the information needed to process such application.

3. Modification/Alteration of Approved Plans. Approved plans shall not be changed, and the work shall be installed as shown on the plans. There shall be no modifications or alterations made to approved plans without first obtaining written permission from the Bureau.

4. Permit Term. Fire Alarm/Suppression System Permits shall lapse and become void unless the work authorized thereby is commenced within one (1) year from the date thereof and completed or resumed within one (1) year from the date that construction begins. In the event of further construction after either of the latter of these time periods, a new permit must be obtained pursuant to all the requirements of the Code then in effect. The fees for such new permit shall be based upon the area (square footage of protected area) remaining to be done.

5. Revocation. If the Bureau shall find at any time that any provisions of this Code, the City of Kenosha Code of General Ordinances, laws, orders, plans and/or specifications are not being complied with, it may revoke the Fire Alarm/Fire Suppression System Permit by written notice stating the error or violation which has occurred. Said notice shall be served on the owner and the general contractor or his/her representative on the job; or, if there is no general contractor, on the person in charge of the work. Service of the notice shall be by either personal service or by mailing a copy of said notice to the address of said person as known to the Bureau. When any such permit is revoked, it shall be unlawful to do any further work until a new permit is issued, except such work as the Bureau shall order to be done as a condition precedent to issuance of a new permit, or which the Bureau may authorize as reasonably necessary to protect work already done on the job, existing property, adjoining property and the public. Additionally, the Bureau may pursue any other remedies for noncompliance with this Code as such remedies are set forth in the City of Kenosha Code of General Ordinances and/or the Wisconsin State Statutes.

6. Correction of Errors. The issuance or granting of a permit or approval of plans or specifications shall not be deemed or construed to be a permit for, or approval of, any violation of any of the provisions of this Code. If, subsequent to the issuance of a permit, errors are discovered in the application, plans, specifications or execution of the work, the Bureau may require the correction of said errors in said application, plans, specifications or construction. The Bureau may rescind the permit and prevent installation/work operations from continuing when in violation of this Code or any Ordinance of the City of Kenosha.

C. Fee Schedule.

1. Scope. The fees fixed in this Ordinance shall be assessed and collected by the Bureau for examination and approval of Fire Alarm System Plans and Fire Suppression System Plans. These fees also include the inspection of newly installed/remodeled Fire Alarm Systems and Fire Suppression Systems. These fees are collected in advance from the owner or agent. This fee schedule applies to plan review and inspections of buildings and premises within the City of Kenosha.

2. Plan Examinations.

a. Plans showing design and construction details, design computations, and specifications submitted for examination and approval as herein required shall be accompanied by a fee in the amount determined in accordance with this Code.

b. For the purpose of determining the fee on the basis of square footage, gross floor area measurements shall be taken from outside of building at each floor level, including basement and other areas affected or serviced by the proposed Fire Alarm System and/or Fire Suppression System. Except as otherwise specified in this Code, the appropriate fee for remodeling or adding to an existing system shall be determined by calculating the square footage of the area to be serviced.

3. Fee Schedule. Failure to obtain a permit before starting work shall result in the fee being doubled. This shall be in addition to any other penalties provided elsewhere in the Code of General Ordinances. Additionally, a penalty of One Hundred (\$100.00) Dollars shall be assessed for each day any work requiring a permit occurs without first obtaining a permit, calculated from the date notice of violation is delivered to either the property owner or contractor performing the work, until such date the owner or contractor submits the proper plans in an approved format to the Bureau.

4. New Systems. Plan Review Fees for new systems shall be determined from time to time by Resolution of the Common Council upon the basis of the total square footage of each building or affected area.

D. Plan Resubmittal. A resubmittal fee of One Hundred Twenty-five (\$125.00) Dollars shall be assessed for review of Fire Alarm System Plans and Fire Suppression System Plans that have been submitted following initial denial of plan approval, if the resubmission is within eight (8) months of the original denial.

A resubmittal fee of Fifty (\$50.00) Dollars shall be assessed for revisions to previously approved plans, and plans that have been previously reviewed, but not denied.

E. Alteration/Modifications To Existing Systems. The fee for review of plans to existing systems shall be Fifty (\$50.00) Dollars. Submittals with alterations of less than twenty-one (21) sprinklers shall have a Fifty (\$50.00) Dollar fee. For these alterations, the descriptions of the type and scope of work, along with cut-sheets for any new sprinklers, shall be provided.

F. Shell Buildings. When an application is submitted for a property where the shell of the building has been completed, the fee will be calculated at fifty (50%) percent of the total fee for that particular fee group. When an application is submitted for construction of the interior of a building where the shell of the building has been previously granted a permit, the fees shall be based on the square footage of that space as a percentage of the entire square footage of the subject building and that fee shall be calculated at fifty (50%) percent of the total fee for that particular fee group.

G. Multiple Identical Buildings. Plans submitted for multiple buildings may be subject to a Multiple Identical Building Fee, which is less than the fee associated with the sum of the individual fees. In order to qualify for the Multiple Identical Building Fee, plans for all buildings shall be submitted at the same time. The fees for the submittal of plans for the first building shall be determined in accordance with the fee schedule established by the Common Council on the basis of the total gross floor area of one building. The fee for each of the remaining identical buildings shall be the higher of either One Hundred Twenty-five (\$125.00) Dollars or twenty-five (25%) percent of the appropriate fee set forth by the Common Council.

H. Certain Devices Subject To A Single Flat Fee. The fee for review of plans for the installation of Fire Protection Systems such as Digital Alarm Communicator Transmitters (DACT), Fire Alarm System Dialers, kitchen hood extinguishing systems, dry chemical extinguishing systems, deluge sprinkler systems which protect openings in fire rate construction, fire detection devices that actuate fire doors/fire shutters, which are not part of any Fire Alarm System, and standpipe systems (not to include combined standpipe systems) shall be One Hundred Twenty-five (\$125.00) Dollars for each type of system submitted. However, no additional fee shall be due if such devices are included as a component in a Fire Alarm or Fire Suppression Systems Plan which has been submitted to the Bureau.

3.27 EXIT SIGNS IN PROXIMITY OF FLOOR

Floor proximity exit signs as required in Paragraph 14.14.1.6 of NFPA 1, shall also be required in all habitable spaces in buildings of Groups A, B, M, E, and I, and in Subgroup R-1, R-2, and R-3. For good cause shown that compliance with this rule would be unduly burdensome for any existing building, upon petition to the Fire Chief by the responsible person, the Fire Chief may relieve the responsible person from compliance of this rule for all or particular spaces of an existing building.

3.28 PERMANENT ROOF ANCHORAGE REQUIRED

Responsible parties for any building which is over three (3) stories shall install and maintain anchorages on the roof of each such building in a number and manner to provide firefighting connection to allow for access to each point of potential emergency rescue, including, but not limited to, all windows, platforms, and all other points of emergency egress, which points of potential emergency rescue are located above the second story above a location that a ladder fire truck could reasonably be positioned. Anchorages required herein shall be of a type used for attachment of personal fall arrest equipment and capable of supporting at least five thousand (5,000 lbs.) Pounds (22.2 kN), and shall be approved by the Fire Department in advance of installation. Anchorages shall be inspected annually and after each use.

3.29 HOOD SYSTEMS AND DUCT-FIRE EXTINGUISHER SYSTEM

A. Definitions.

1. Hood. The term "Hood" means a housing and associated mechanisms that provides ventilation control and fire protection of commercial cooking operations pursuant to the NFPA Section 96.

2. New Hood. The term "New Hood" means a hood installed prior to the issuance of a Certificate of Occupancy, and means the subsequent replacement of a preexisting Hood, regardless of whether the preexisting Hood was subject to inspection pursuant to this Section.

B. Requirement. All commercial kitchens and all industrial kitchens shall have at least one (1) adequate hood system and at least one (1) duct fire extinguishment system.

C. Hood System. All hood systems installed or maintained pursuant to this Section must be approved by the Underwriters' Laboratories, must conform to the requirements of NFPA 96 and be approved by the Bureau.

D. Duct-Fire Extinguishment System. All duct-fire extinguishment systems installed or maintained pursuant to this Section must conform to the requirements of NFPA 96 and be approved by the Bureau.

E. Permit. Prior to the installation of a hood system or a duct-fire extinguishment system, a Hood System/Duct-Fire Extinguishment System Permit shall be obtained from the Bureau. Applications for said permit shall be on forms provided by the Bureau, and shall include full plans and specification for the proposed hood system and/or duct-fire extinguishment system, along with such other information that may be reasonably required by the Chief of the Fire Department. The Common Council shall, from time to time, by Resolution, determine the fee for such permit.

F. Inspection Required.

1. Initial Inspection. Prior to the issuance of a Certificate of Occupancy for the premises pursuant to Section 9.09, satisfactory operation of the hood system and/or the duct-fire extinguishment system must be demonstrated to the Bureau by a field and acceptance testing of the hood system and/or the duct-fire extinguishment system, which testing must be conducted by the applicant for the Hood System/Duct-Fire Extinguishment System Permit, by the applicant for a Certificate of Occupancy, or any other responsible party, and which testing must be witnessed by the Bureau.

2. Semiannual Testing. Subsequent to the initial inspection, all duct-fire extinguishing systems shall be maintained in an operable condition as demonstrated by semiannual testing by a factory-authorized representative. Such semiannual testing must be evidenced by a certification tag of the inspection attached to the extinguishing agent system or discharge canister. The first such semiannual inspection shall occur no later than nine (9) months after the initial inspection.

G. Inspection Fee. For each reinspection of a New Hood, prior to the inspection or reinspection, the owner of the premises upon which the New Hood is installed shall pay a New Hood Inspection Fee which shall be determined from time to time, by the Common Council through Resolution.

3.30 EMERGENCY RESPONSE ENCLOSURES

A. Definitions.

1. Fire Protections Closet. The term "Fire Protections Closet" means an enclosure containing firefighter operations equipment.

2. Key Box System. The term "Key Box System" means a key-openable safe mounted about the exterior of a building.

B. Fire Protections Closet.

1. Fire Protections Closet Required. Prior to the issuance of a Certificate of Occupancy for buildings having at least three (3) floors, a building owner shall install a Fire Protections Closet on each floor other than the ground floor. Once installed, the owner shall maintain the Fire Protections Closet in the manner required herein as long as the building is occupied. The door of said Fire Protections Closet shall be labeled, with a minimum three (3") inches in height lettering, "FC".

2. Dimensions. The Fire Protections Closet shall have the minimum dimensions of eighty-four (84") inches in height, thirty-two (32") inches in width (measured as a dimension parallel to a hallway wall with which it is associated), and twenty-four (24") inches deep (measured as a dimension perpendicular to a hallway wall with which it is associated).

3. Placement. The Fire Protections Closet shall be located near the floor exits in places directed by the Fire Department.

4. Contents. The Fire Protections Closet will contain emergency response materials or equipment approved by the Fire Department for that Fire Protections Closet. The Fire Protections Closet may not contain materials or equipment that have not been approved for that Fire Protections Closet by the Fire Department. Equipment shall be determined by the occupancy, square footage and life safety hazards of the floor.

5. Locks. The Fire Protections Closet will be locked with a key lock which key shall be labeled and placed in the Key Box System associated with the building in which the Fire Protections Closet is located.

C. Key Box System.

1. Key Box System Required. Where required, a building owner shall install a Key Box System of a type approved by the Fire Department prior to installation. The Key Box System shall be accessible by a single key that is keyed to a single master key, which master key is controlled by the Fire Department. After installation, the original and all copies of the accessing key shall be given to the Fire Department. Once installed, the owner shall maintain the Key Box System in the manner required herein as long as the building is occupied. Should maintenance of the Key Box System require access to the interior of the Key Box System, the owner must request access from the Fire Department. A Key Box System shall be required in the following circumstances:

a. For new construction subject to a requirement of a Certificate of Occupancy, with installation being a condition precedent to the issuance of the Certificate of Occupancy;

b. For existing structures undergoing a change of occupancy, which change of occupancy is subject to a requirement of a Certificate of Occupancy, with installation being a condition precedent to the issuance of the Certificate of Occupancy;

c. Subject to an order for installation and maintenance of a Key Box System issued by the Fire Chief for any other structure that the Fire Chief reasonably believes, due to aspects unique to the structure, should have a Key Box System installed and maintained to protect the general public safety and welfare of the citizens and firefighters of the City. An owner of a structure subject to an order from the Fire Chief for installation and maintenance of a Key Box System may appeal such order to the Committee on Public Safety and Welfare, but only if such appeal is filed with the City Clerk within ten (10) days of issuance of said order.

2. Placement. The Key Box System shall be mounted near the building entrance in a place directed by the Fire Department.

3. Contents. Key Box Systems shall contain the entrance keys for the building (clearly marked as the entrance keys), access cards or keys to every space within the building (clearly marked for the spaces with which the cards or keys are associated), keys to Fire Protection Closets, and floor plans for the building (including space designations and lock locations for access cards or keys in the Key Box System).

4. Additional Security. Key Box Systems may be coupled with a burglar alarm system so that opening the Key Box System activates the burglar alarm, provided, however, that the owner or manager of the building responds to the alarm within thirty (30) minutes of the initial sounding of the alarm, and

disables the alarm as soon as practicable after response. Failure of an owner or manager to respond timely or to disable timely the burglar alarm coupled with a Key Box System is a violation of this Ordinance.

3.31 STANDPIPES FOR PARKING STRUCTURES

A. Definitions.

1. **Parking Garage(s).** The term "Parking Garage" as used herein shall mean either an open or closed parking garage as those terms are used in Section 406.2 of the Wisconsin Enrolled Commercial Building Code.

2. **Standpipe System.** The term "Standpipe System" as used herein shall mean a dry standpipe system of the type described in Section 905 of the Wisconsin Enrolled Commercial Building Code.

B. Standpipe System Required. Prior to the issuance of a Certificate of Occupancy for a Parking Garage having at least two (2) floors, the owner of the Parking Garage shall install a Standpipe System with connections on each floor above the ground floor, which connections are subject to approval by the Fire Department prior to installation. Once installed, the owner shall maintain the Standpipe System in the manner required herein as long as the Parking Garage is occupied.

3.32 STORAGE TANKS FOR CLASS I, II AND III LIQUIDS

A. Definitions. Class I, II and III liquids shall have the meaning provided therefor in COMM 10, Wisconsin Administrative Code.

B. Adoption Of COMM 10, Wisconsin Administrative Code, By Reference. COMM 10, Wisconsin Administrative Code, is hereby adopted and incorporated by reference.

C. Responsibility Of Owners And/Or Operators Of Storage Tanks. The owner and/or operator of any aboveground or underground storage tank for Class I, II or III liquids shall, at all times, be responsible for the integrity of each storage tank at each location, together with the piping and dispensing systems connected therein from the time of installation until termination of use, in accordance with COMM 10 of the Wisconsin Administrative Code.

D. Enforcement Of COMM 10, Wisconsin Administrative Code. Pursuant to COMM 10, Wisconsin Administrative Code, and the terms of a Professional Services Contract between the City and the Wisconsin Department of Workforce Development, the Fire Department is authorized to issue permits, charge fees, and take enforcement action authorized thereby. The Chief of the Fire Department, and designee(s) thereof, shall enforce this Ordinance and the groundwater protection-related provisions of COMM 10, Wisconsin Administrative Code, in the City of Kenosha.

E. Storage Tank Permit. A permit, under COMM 10, Wisconsin Administrative Code, through the Fire Department, shall be required for the abandonment, closure, removal or change in service or placing the system temporarily out of service, of any aboveground or underground storage tank for Class I, II or III liquids with a capacity of more than sixty (60) gallons. Storage tank system shall include piping, vents, leak detection systems, cathodic protection and spill/overflow protection systems.

The owner and/or operator of any such storage tank shall file an application therefor with the Fire Department, on designated forms with the applicable fee. The application shall include all rules and requirements of COMM 10.

3.33 APPEALS

The applicant for a permit, or the owner, or occupant of any building, structure or premises affected, may appeal to the Chief of the Fire Department the decision of the Bureau to disapprove an application or refuse to grant a permit applied for, or when it is claimed that any provision of the Chapter has been misconstrued or wrongly interpreted. Such appeal shall be filed within ten (10) days from the date of such decision or of an order properly issued by the Bureau.

3.34 FAILURE TO COMPLY WITH ORDERS

A. Noncompliance. Failure to comply with any orders issued pursuant to the provisions of this Chapter by the Chief of the Fire Department or the Bureau, or duly authorized representatives, shall constitute an Ordinance violation, and any person, firm or corporation found guilty of such violation shall, upon the conviction thereof, be required to forfeit a sum not less than One Hundred (\$100.00) Dollars nor more than One Thousand (\$1,000.00) Dollars, together with the costs of the prosecution, and in default of payment thereof shall be imprisoned until such forfeiture and cost are paid, but not to exceed fifteen (15) days.

B. Separate Offense. Except as otherwise provided in this Chapter, each and every twenty-four (24) hours such violation shall continue shall constitute a separate offense.

3.35 PENALTIES, GENERAL

A. Penalties. Any person, firm or corporation found guilty of a violation of any section of this Chapter for which a specific penalty is not herein provided shall, upon conviction thereof, be required to forfeit the sum of not less than One Hundred (\$100.00) Dollars nor more than One Thousand (\$1,000.00) Dollars, together with the costs of the prosecution, and in default of payment thereof shall be imprisoned until such forfeiture and cost are paid, but not to exceed thirty (30) days.

B. Separate Offense. Each and every twenty-four (24) hours such violation shall continue, except as otherwise provided in this Chapter, shall constitute a separate offense.

3.26 VALIDITY

Should any section, subsection, paragraph, sentence, clause, phrase or word of this Chapter be declared for any reason to be invalid or unconstitutional, the remainder of this Chapter shall not be affected thereby and shall continue in full force and effect.

All ordinances or parts of ordinances contravening the provisions of this Ordinance are hereby repealed.

CHAPTER IV
HEALTH

4.01 ADMINISTRATOR OF HEALTH

For purposes of the Charter Ordinances, the "City Health Administrator" means the Mayor or his/her designee.

For purposes of the Code of General Ordinances or the Zoning Ordinance, "Administrator of Health", "Health Department Administrator", "Health Officer", or similar term means the Director of the Kenosha County Health Department, or designee(s) thereof, acting as the City enforcing agent under the provisions of a contract between the City and County of Kenosha.

4.02 MANURE

No manure shall be stored in the City, except in a fly proof and impervious container or covered with 6 inches of earth, except in the A-1 and A-2 Zoning Districts where manure may be stored in the open, conditioned upon it being intended for use as a fertilizer upon the land upon which stored, it being stored for no more than six (6) months, and it being stored in such manner so as to not constitute a public nuisance or a health hazard.

4.03 MOBILE HOMES AND PARKS

A. Additional Regulations on Mobile Homes and Mobile Home Parks. Wrecked, damaged or dilapidated mobile homes shall not be kept or stored in a Mobile Home Park or upon any premises in the City. The Inspector shall determine if a mobile home is damaged or dilapidated to a point which makes it unfit for human occupancy. Such mobile homes are hereby declared to be a public nuisance. Whenever the Inspector so determines, he shall notify the licensee or landowners and owner of the mobile home in writing that such public nuisance exists within the park or on lands owned by him giving the findings upon which his determination is based and shall order such home removed from the park or site or repaired to a safe, sanitary and wholesome condition of occupancy within a reasonable time.

B. Enforcement of COMM 95. Section COMM 95 of the Wisconsin Administrative Code shall be enforced by the Kenosha County Health Department under authority of Chapter 16 of the Kenosha County Environmental Health/Food Ordinance.

4.04 BUSINESS CAPACITY AND FACE COVERING REGULATIONS PERTAINING TO CORONAVIRUS (COVID-19)

FINDINGS AND PURPOSE

A. Findings

1. In December 2019, the novel coronavirus (COVID-19) was first identified and since that time has spread throughout the world, including to every state in the United States.
2. The first cases of COVID-19 appeared in the United States in January 2020 and the risk of community spread of COVID-19 has grown exponentially since that time.
3. That on March 11, 2020, the World Health Organization declared COVID-19 a pandemic.
4. That on March 25, 2020, the Common Council to address the novel Coronavirus COVID-19 declared a state of emergency in the City of Kenosha by resolution pursuant to its authority under Wis. Stats. Sections 323.11 and 323.14.
5. That as of September 18, 2020, Wisconsin has had more than 94,000 identified cases of COVID-19, including 911 deaths.
6. That since September 18, 2020, there have been 3,209 confirmed positive COVID-19 cases identified in Kenosha County, 2,235 of which have occurred in the City of Kenosha.
7. The Centers for Disease Control and Prevention ("CDC") continues to recommend certain actions for the preparation and mitigation of community transmission of COVID-19, including, but not limited to, social distancing measures, restricting the size of gatherings and face coverings.

CODE OF GENERAL ORDINANCES, 2021 - KENOSHA, WISCONSIN

8. The CDC Public Health Considerations for Reopening Restaurants and Bars During the COVID-19 Pandemic encourages social distancing and enhanced spacing at establishments including by limiting party sizes and occupancy.

9. The State of Wisconsin Badger Bounce Back Plan and the County of Kenosha Kickstart Plan each promote reduction of business capacity and limiting table sizes to ensure adequate social distancing.

10. That the Cities of Milwaukee, Racine, Green Bay, Shorewood and Superior have adopted mask ordinances to combat the transmission of COVID-19.

11. That major retailers in Kenosha County with a statewide presence have mandated face covering requirements in their business locations. Those businesses include, Kohl's, Meijer, Walmart, Sam's Club, Festival Foods, Menard's, Woodman's, Costco and Pick 'N Save.

12. That on August 1, a statewide face mask mandate went into effect by executive order of Wisconsin Governor Tony Evers. Governor Evers extended the mandate on September 22, 2020, and set an expiration date of November 21, 2020. On October 16, 2020, a lawsuit challenging the mandate was filed with the Wisconsin Supreme Court and the decision is pending.

13. That on September 17, CDC Director Robert Redfield said, "The best defense we currently have against this virus are the important mitigation efforts of wearing a mask, washing your hands, social distancing and being careful about crowds."

14. That on November 11, the Wisconsin Department of Health Services reported 6,922 cases in Kenosha County and 100 deaths; the state's fifth highest mortality rate.

15. The Council finds that it is in the best interest of the public peace, health, welfare, and safety, and to preserve the lives of citizens of the City of Kenosha to provide operational recommendations for businesses operating within the City of Kenosha.

B. Purpose. The City of Kenosha pursuant to the emergency powers authorized by Sections 323.11 and 323.14 require the following regulations relating to the novel coronavirus (COVID-19) which are necessary in order to protect, preserve, and promote the general health, safety, and welfare of the public and intended to slow the future spread of COVID-19.

C. Definitions. As used in this section, the terms below have the following meanings.

1. "Building Open To Public as used herein means any structure used in whole or in part as a place of resort, assemblage, lodging, trade, traffic, occupancy, or other use by the public.

2. "Business" as used herein is any place of employment.

3. "Face Covering or mask" as used herein is a device to securely cover the nose and mouth of a person which remains affixed in place without the use of one's hands, to impede the spread of saliva or other fluids during speaking, coughing, sneezing or other intentional or involuntary action. Medical grade masks are not required; coverings may be fashioned from scarves, bandannas, gaiters or other suitable fabrics. The mask must securely cover the mouth and nose of the wearer.

4. "Party" and "Parties" as used herein means groups of six or fewer adult patrons. Minors are allowed and not included in party limits.

5. "Patron" as used herein means a customer of any business defined in Section D. herein and does not include the owners, employees or staff of any such business.

6. "Premises" as used herein means the business building, structure or any portion thereof together with the parking lot, patio and other outdoor seating area for such business.

7. "Public space" as used herein means any indoor or outdoor space that is open to the public. This does not include any private residence, private residence, private residential property, or private offices or workspace that are not open to customers or to public visitors.

8. "Seating" as used herein means patron seating at tables, counters and bars.

9. "Social distancing" as used herein means separation of at least six (6) feet between all individuals on the premises including but not limited to employees, customers, and members of the public and limit the number on the premises, except for those contacts that are incidental and brief in nature. This shall not be construed to require physical distancing between individuals from the same household.

D. Business Operations.

1. Limit the number of people on the premises to no more than is strictly necessary to perform the business operation.

2. To the greatest extent possible, comply with social distancing of 6 feet between all individuals on the premises, including but not limited to employees, customers, and members of the public. Businesses may have to rearrange office space, tables, workspace, or the flow of business in order to provide for social distancing.

3. Increase standards of facility cleaning and disinfection of all areas. This should include an emphasis on high-touch areas such as door handles, railings, restrooms, buttons, touch screens, office equipment, tools, shared vehicles, payment devices or cash registers, and counters. Businesses should adopt protocols to clean and disinfect the premises in the event of a positive COVID-19 case in the workplace.

4. Post signage reminding staff and customers of safe business practices, social distancing requirements, hand hygiene, and cough/sneeze etiquette.

E. Use of Face Coverings

1. All persons in the City of Kenosha must cover their mouths and noses with a face covering when:

- a. In any Building Open To Public; or
- b. Waiting for or riding on public transportation or riding in a taxi, private care service, or ride-sharing vehicle.

2. All businesses, organizations, and non-profit entities within the City of Kenosha must require all employees, customers, visitors, members, or members of the public to wear a face covering when:

- a. Employees are working in any space visited by customers or members of the public, regardless of whether customers or members of the public are present at the time.
- b. Employees who are working in any space where food is prepared or packaged for sale or distribution to others.
- c. Customers, visitors, members, or members of the public are in a facility managed or operated by the business, organization, or entity.
- d. Employees are in any room or enclosed area where other people, except for members of the same family or household, are unable to maintain a six-foot distance except for infrequent or incidental moments of closer proximity.

3. **Exemptions.** Face coverings are not be required:

- a. For children aged five years or under.
- b. Persons who fall into the Centers for Disease Control and Prevention's guidance for those who should not wear face coverings due to a medical condition, mental health condition, developmental disability, or are otherwise covered under the Americans with Disabilities Act.
- c. Persons who have upper-respiratory chronic conditions, silent or invisible disabilities.
- d. Persons who are hearing impaired, or communicating with a person who is hearing impaired, where the ability to see a person's mouth is essential for communication.
- e. Persons who are obtaining a service involving the nose, mouth, or face for which temporary removal of the face covering is necessary to perform the service.
- f. Persons who are seated at a restaurant or other establishment that offers food or beverage service, while they are eating or drinking, provided they maintain a six-foot distance between individuals, not including individuals who are members of the same family or household or are seated together, with only infrequent or incidental moments of closer proximity.
- g. Persons for whom wearing a face covering would create a risk to the person related to their work, as determined by local, state, or federal regulations or workplace safety guidelines.
- h. Whenever federal, state, or local law otherwise prohibit wearing a face mask or where it is necessary to evaluate or verify an individual's identity.
- i. Persons whose religious beliefs prevent them from wearing a face covering.
- j. While exclusively with members of a family or the same household, and no person other than such family or household is within the same enclosed area.
- k. In private, individual offices or office suites.
- l. Persons in settings where it is not practical or feasible to wear face coverings when obtaining or rendering goods or services to the extent necessary to obtain or render such goods or services including but not limited to the receipt of dental services or medical treatments or consuming food or beverages.
- m. Persons present in government facilities closed to the public, institutions of higher education, public and private K through 12 schools, and childcare or youth facilities that have a mitigation strategy approved by the Kenosha County Health Department.

F. Refuse Entry or Service. The owner or operator of any business or building may refuse entry or service to any person who fails to comply with this section.

G. Enforcement.

1. The Kenosha County Health Department is authorized to enforce this section.
2. Officers of the City of Kenosha Police Department are authorized to enforce provisions of this Section with regard to compliance in establishments that have a Class "A", "Class A", Class "B", "Class B", or "Class C" license, or combination thereof upon receiving a verified complaint.

H. Severability.

If any provision of this Ordinance or its application to any person or circumstance is held to be invalid, then the remainder of the Ordinance, including the application of such part or provisions to other persons or circumstances, shall not be affected and shall continue in full force and effect. To this end, the provisions of this Ordinance are severable.

I. Penalties.

1. Any owner, operator, manager, or person having control of a business found guilty of failing to enforce any provision of Paragraph 4.04. E.2., upon conviction thereof, is subject to a forfeiture not to exceed Two Hundred Fifty Dollars (\$250.00), together with the costs of prosecution.
2. If any person continues to violate this Section after notice is given by an owner, operator, manager, or person having control of a business, or by a police officer or a representative of the Kenosha County Health Department, a citation may be issued to the individual in lieu of the business. Upon conviction of a violation of this section 4.04, the person is subject to a forfeiture not to exceed Twenty-five Dollars (\$25) upon the first conviction, Fifty Dollars (\$50) upon the second conviction, and One Hundred Dollars (\$100) upon the third or subsequent conviction, together with the costs of prosecution.

J. Sunset. This ordinance remains in effect until May 27, 2021, unless extended or earlier terminated or modified by the common council.

4.05 SMOKING PROHIBITED

A. Provisions of State Law Adopted by Reference. The provisions of Wisconsin Statute Section 101.123 and any future amendments, revisions or modifications of the Statute are incorporated and are adopted in their entirety.

B. Electronic Cigarettes

1. Definitions. For purposes of this Section, the following definitions apply:

"Electronic Smoking" is the use of an electronic smoking device to create an aerosol or vapor.

"Electronic Smoking Device" means any portable product capable of converting a nicotine-containing solution into an aerosol or vapor, which aerosol or vapor is meant to be consumed through inhalation.

"Electronic Smoking Lounge" means a Retail Establishment, as that term is defined in Wisconsin Statutes §101.123(1)(eg), that satisfies all of the following:

- (1) does not have a Class "A" (fermented malt beverage) license, "Class A" (intoxicating liquor) license, Class "B" (fermented malt beverage) license, "Class B" (intoxicating liquor) license, "Class C" (wine) license, and/or a restaurant license;
- (2) generates seventy-five percent (75%) or more of its gross, annual income from the retail sales of Electronic Smoking Devices; and
- (3) in which the Electronic Smoking was permitted by adult members of the public prior to March 1, 2019.

2. Prohibitions against smoking under this section include Electronic Smoking. It is a violation of this ordinance for a person to engage in Electronic Smoking in violation of this ordinance and for a person having control of a Retail Establishment premises to permit Electronic Smoking on the premises in violation of this ordinance.

3. Exception. The prohibitions against Electronic Smoking in paragraph 2. do not apply to the following:

CODE OF GENERAL ORDINANCES, 2021 - KENOSHA, WISCONSIN

- (a) A private residence.
- (b) A room used by only one person in an assisted living facility as his or her residence.
- (c) A room in an assisted living facility in which 2 or more persons reside if every person who lives in that room engages in Electronic Smoking and each of those persons has made a written request to the person in charge of the assisted living facility to be placed in a room where Electronic Smoking is allowed.
- (d) An Electronic Smoking Lounge that was in existence on March 1, 2019, and in which only the Electronic Smoking by adults is allowed.

C. Penalties. Penalties for violation of this section shall be in accordance with Wisconsin Statute Section 101.123. Statutory court costs, surcharges, fees and assessments shall be added to all forfeitures for such violations.

D. Inspection and Enforcement. The County Health Department and the Departments of City Inspections, Police Department and Fire Department shall have the authority to enforce the provisions of this section, including the power to enter locations to ensure compliance with this ordinance.

4.06 RENDERING PLANTS

The provisions of Chapter ATCP, §57.09 of the Wisconsin Administrative Code are hereby adopted and made a part of this Chapter as if set forth in detail herein.

4.07 ARTIFICIAL LIGHT AND GLARE

A. Regulation. All outdoor lighting shall be subject to the following regulation.

1. Outdoor lighting on residential property producing artificial light during periods of darkness shall be directed or shielded appropriately to minimize potential glare and to avoid creating a nuisance to neighboring properties.

2. Illumination Intensity. All luminaries, including light fixtures, with a total luminous flux greater than one thousand (1,000) initial lumens shall be full cutoff, or shall be shielded or installed so that there is not a direct line of sight between the light source and/or lamp or its reflection and a point five (5') feet or higher above the ground at the property boundary.

B. Exemption. Low output outdoor lighting of the type having no individual bulb or lamp that has a rating of greater than five watts is exempt from the restrictions of this section.

4.08 PENALTIES

Unless otherwise provided in this Chapter, any person, party, firm or corporation violating any provision of this Chapter shall, upon conviction thereof, be punished by payment of a forfeiture not less than Twenty-five (\$25.00) Dollars, nor more than Five Hundred (\$500.00) Dollars, and in default of such payment of forfeiture and costs, shall be committed to the County Jail for a period of not more than sixty (60) days.

CHAPTER V
PUBLIC WORKS AND SERVICES

5.01 PUBLIC WORKS GENERAL

A. Wisconsin Statutes. All Wisconsin Statutes as they now exist or as they may hereinafter be amended relative to public works and sanitary sewer and water service are incorporated herein by reference and made a part of this Chapter as if fully set forth herein.

B. State Administrative Code. All provisions of the State Administrative Code as they now exist or as they may hereinafter be amended relative to public works and sanitary sewer and water service are incorporated herein by reference and made a part of this Chapter as if fully set forth herein.

C. Work by City. The City, including its Water Utility, reserves the right to do any class of public work or part thereof through its own crews, without first taking bids therefor.

D. Public Right-of-Way Defined. "Public Right-of-Way" or "Right-of-Way", in this Chapter, shall mean and include highways, streets, alleys and any other publicly owned areas designated by any unit of government as a route for pedestrian or vehicular traffic.

5.02 UNDERGROUND UTILITIES IN RECONSTRUCTED MAJOR STREETS

A. Definitions. The following terms, as used herein, shall have the meanings below provided:

1. **Major Streets** shall mean the greater, more important streets forming the radial, arterial and crosstown thoroughfares of the City of Kenosha.

2. **Utilities** shall mean electric, telephone and cable television lines and appurtenances.

B. Underground Utilities In Reconstructed Major Streets. When a Major Street is reconstructed or rebuilt requiring the existing utility poles to be relocated, consideration shall be given to place such utilities underground or relocated off site. The construction cost of moving the existing poles, borne by the Utility, shall be offset by the cost of placing the utility underground in determining the estimated project cost. The Committee on Public Works (Board of Public Works) shall perform a cost-benefit analysis before including the relocation work of such utilities in the project.

5.03 STORM SEWERS

A. Definitions. The following terms shall have the meaning below provided:

1. **Storm Sewer.** A pipe or conduit designed and used to transport runoff water from rain, snow or other unpolluted source.

2. **Storm Water.** Storm Water shall mean water from rain or snow as it accumulates and runs upon the surface of land whether or not developed.

3. **Storm Water Collection Facilities.** The storm sewers, structures, conduit, detention basins and equipment designed and used to collect and transport unpolluted water from the point of origin to Lake Michigan.

B. Prohibitions. No person, party, firm or corporation shall:

1. Discharge any wastewater, or prohibited wastewater, as those terms are defined in Chapter XXXII, §32.08, Rule 08-01 of the Code of General Ordinances, into a storm sewer or storm water collection facilities.

2. Destroy, damage or interrupt the flow of any storm sewer or storm water collection facilities without a permit to do so from the Director of Public Works, or designee thereof.

3. Discharge storm water into any wastewater collection facilities, as that term is defined in Chapter XXXII, §32.08, Rule 08-01 of the Code of General Ordinances.

4. Connect or cause to be connected a storm sewer to any sanitary sewer.

5. Loosen the ground or perform any work in the vicinity of a storm sewer or storm water collection facilities without first obtaining a permit to do so from the Director of Public Works.

5.035 SURFACE WATER DRAINAGE FLOW

A. Requirement. The owner of every parcel and lot shall maintain surface water drainage flow as provided in a drainage plan approved as part of any subdivision plat or plan, Conditional Use Permit or Building Permit.

B. Enforcement. The Director of Public Works or Director of Engineering Division shall issue a written notice of violation to the owner or owner's agent of every parcel or lot whenever it comes to their attention that surface water is draining upon or from any such parcel or lot contrary to an approved drainage plan. The order shall provide a reasonable time for compliance.

C. Appeal. Any order provided for in §B. may be appealed to the Board of Public Works (Committee on Public Works) within ten (10) days of date of said order by filing a notice of appeal with the Department of Public Works. In the event of an unsuccessful appeal, the time for compliance with the order shall commence to run two (2) days following the mailing of the decision of the Board of Public Works (Committee on Public Works) to the owner or owner's agent. The Board of Public Works (Committee on Public Works) may affirm, reverse or modify the order appealed, or extend the time for compliance.

D. Violations. Each day of noncompliance with the order shall be deemed a violation of this Ordinance, commencing with the day following the last date provided for compliance. Every day of noncompliance shall be deemed a separate offense.

5.039 PUBLIC RIGHT-OF-WAY RESTORATION STANDARDS

A. Standards Established. The Common Council of the City of Kenosha shall, from time to time, by Resolution, establish standards for public right-of-way restoration to apply whenever any person, party, firm or corporation, whether public or private, opens any public right-of-way to perform any work therein. The standards shall address permanent and temporary work. The standards may include a notice procedure and provide time for voluntary compliance prior to the application of the penalty provisions of this Chapter.

B. Permit Condition. Any permit or authorization under this Chapter or any other Ordinance to open a public right-of-way shall include standards for restoration of the public right-of-way established under this Ordinance.

C. Non-Permit Work. Any person, party, firm or corporation who opens any public right-of-way without having a required permit, in addition to being subject to the forfeiture provisions of this Chapter, shall restore the public right-of-way in accordance with the standards for public right-of-way restoration established under this Ordinance.

D. Violation. It shall be a violation of this Ordinance for any person, party, firm or corporation to open a public right-of-way and fail to restore the public right-of-way in accordance with the standards for public right-of-way restoration established under this Ordinance.

5.04 PUBLIC UTILITIES, RIGHT-OF-WAY EXCAVATION, STREETS, AND ALLEYS

A. Findings and Purpose. In the exercise of its police powers, the City has priority over all other

uses of the public rights-of-way. The City desires to anticipate and minimize the number of obstructions and excavations taking place in the public rights-of-way to ensure that the rights-of-way remain available for public services and safe for public use. The taxpayers of the City bear the financial burden for the upkeep of the rights-of-way and a primary cause for the early and excess deterioration of the public rights-of-way is the frequent excavation by Person who place facilities therein.

The City finds that there has been an increase in the use of the public rights-of-way and, as a result, increased costs to the taxpayers of the City and that these costs are likely to continue into the foreseeable future.

The City finds that excavation and occupancy of the public rights-of-way causes direct and indirect costs to be borne by the City and its taxpayers, including but not limited to:

1. Administrative costs associated with public rights-of-way projects, such as registration, permitting, inspection and supervision, supplies and materials.
2. Management costs associated with ongoing management activities necessitated by public right-of-way users.
3. Repair costs to the roadway associated with the actual excavation into the public right-of-way.
4. Degradation costs defined as depreciation caused to the roadway in terms of decreased useful life, due to excavations into the public rights-of-way.

In response to the foregoing facts, the City hereby enacts this ordinance relating to the administration and permitting of excavation, obstruction and/or occupancy of the public rights-of-way, together with an ordinance making necessary revisions to other Code provisions. These ordinances impose reasonable regulations on the placement and maintenance of facilities currently within in rights-of-way or to be placed therein at some future time. It is intended to complement the regulatory roles of state and federal agencies.

The purpose of this ordinance is to provide the City a legal framework within which to regulate and manage the public rights-of-way, and to provide for recovery of costs. This ordinance provides for the health, safety and welfare of the residents of the City as they use the rights-of-way of the City, as well as to ensure the structural integrity of the public rights-of-way.

Under this chapter, all Persons who excavate, obstruct and/or occupy the public rights-of-way will reimburse the City's administrative, ongoing management and degradation costs. Right-of-way users will bear a fair share of the financial responsibility for the integrity of the public rights-of-way.

B. Definitions. The following definitions apply in this ordinance. References hereafter to "sections" are, unless otherwise specified, references to sections in this ordinance. Defined terms remain defined terms whether or not capitalized.

1. **Applicant** means any person requesting permission to excavate, obstruct and/or occupy a right-of-way.
2. **City** means the City of Kenosha.
3. **County** means Kenosha County.
4. **Degradation** means the accelerated depreciation of the right-of-way, caused by an excavation of the right-of-way, resulting in the need to reconstruct such right-of-way earlier than would be required if the excavation did not occur.
5. **Department** means the City's Director of Public Works or designee.
6. **City Inspector** means any person authorized by the Department to carry out inspections relating to the provisions of this chapter.

CODE OF GENERAL ORDINANCES, 2021 - KENOSHA, WISCONSIN

7. Emergency means a condition that (1) poses a clear and immediate danger to life or health, or of a significant loss of property or (2) requires immediate repair or replacement in order to restore service to a customer.

8. Encroach means to place any object in or over a right-of-way as to begin to restrict free and open passage over/under on or in that or any part of the right-of-way.

9. Excavate means to dig into or in any way remove or physically disturb or penetrate any part of a right-of-way.

10. Facilities means all equipment owned, operated, leased or subleased in connection with the operation of a service or utility service, and shall include but is not limited to poles, wires, pipes, cables, underground conduits, ducts, manholes, vaults, fiber optic cables, lines and other structures, appurtenances or any underground sprinkler/irrigation system.

11. In, when used in conjunction with "right-of-way", means over, above, in, within, on or under a right-of-way.

12. Lawn Park shall mean the area between the public sidewalk and the curblin of the street. Where there is no sidewalk, Lawn Park shall mean the area between the property line and the curblin of the street.

13. Local representative means a local person or persons, or designee of such person or persons, authorized by a registrant to accept service and to make decisions for that registrant regarding all matters within the scope of this chapter.

14. Obstruct means to place any object in a right-of-way as to hinder free and open passage over/under on or in that or any part of the right-of-way.

15. Occupy means to dwell or reside above, on, in, or below the boundaries of the public rights-of-way.

16. Permittee means any person to whom a permit to excavate or occupy a right-of-way has been granted by the City under this chapter.

17. Person means, municipality, corporation, company, including a "Company" defined as Wis. Stat. §182.017(1g)(b), association, firm, partnership, limited liability company, limited liability partnership and individuals and their lessors, transferees and receivers.

18. PSCW means the Public Service Commission of Wisconsin.

19. Public Utility has the meaning provided in Wis. Stat. §196.01(5).

20. Registrant means any person who has registered with the City (1) to have its facilities located in any right-of-way or (2) to use or seek to occupy or use the right-of-way or any facilities in the right-of-way.

21. Repair means to perform construction work necessary to make the right-of-way useable for travel, according to department specifications, or to return facilities to an operable condition that is in as good or a better condition as the facilities were before the work commenced.

22. Right-of-way or Public Right-of-way means the surface and space above and below a public roadway, highway, street, bicycle lane, lawn park, shoulders, side slopes, and public sidewalk in which the City has an interest, including other dedicated rights-of-way for travel purposes.

23. Rights-of-way User means a person owning or controlling a facility in the public right-of-way, or seeking to own or control a facility in the public right-of-way.

24. Residential Utility means construction or utility placement that would be maintained by the adjacent resident, not including service or utility service.

25. Service or utility service includes services such as municipal sewer and water services and services provided by a Public Utility or a Company subject to Wis. Stat. §182.017 and other similar services.

26. Sidewalk shall mean the area within a street or highway right-of-way used or reserved for pedestrian traffic.

27. Supplementary application means an application made to excavate or obstruct more of the right-of-way than allowed in, or to extend, a permit that has already been issued.

28. Unusable facilities means facilities in the right-of-way which have remained unused for one year and for which the registrant is unable to provide proof that it has either a plan to begin using them within the next twenty-four (24) months or a potential purchaser or user of the facilities.

C. Administration.

The Department is responsible for the administration of the rights-of-way, and the permits and ordinances related thereto.

D. Registration for Right-of-way Occupancy/Excavation.

1. Registration. Each service, utility service or right-of-way user who occupies, uses, or seeks to occupy or use, the right-of-way or any facilities in the right-of-way, including by lease, sublease or assignment, or who has, or seeks to have, facilities located in any right-of-way shall register with the Department and pay the fee on file with the Department. Registration will consist of providing application information and paying a registration fee. This section shall not apply to those persons exclusively utilizing facilities provided by another right-of-way user.

2. Registration Prior To Work. No person may construct, install, repair, remove, relocate, or perform any other work on, or use any facilities or any part thereof in any right-of-way without first being registered with the Department.

a. Exceptions.

(1) Nothing herein shall be construed to repeal or amend the provisions of a City ordinance requiring persons to plant or maintain the lawn park in the area of the right-of-way between their property and the street curb, construct sidewalks, erect mailboxes or perform other similar activities.

(2) Work Excluded. The provisions of this Ordinance shall not apply to excavation work: (a) under the direction of the Department of Public Works by City employees; (b) the Kenosha Water Utility; (c) contractors performing work under contract with the City of Kenosha Department of Public Works or the Kenosha Water Utility; (d) County or contractors performing work for County done pursuant to a contract between the City and County necessitating openings or excavations in City streets or other public ways, which openings or excavations shall be regulated by the contract between the City and the contractor.

E. Registration Information.

1. Information Required. The information provided to the Department at the time of registration shall include, but not be limited to:

a. Each applicant/registrant's name, Diggers Hotline registration certificate number, address, e-mail address, telephone number and facsimile numbers.

b. The name, address, e-mail address, telephone number and facsimile numbers of a local representative. The local representative or designee shall be available at all times. Current information regarding how to contact the local representative in an emergency shall be provided at the time of registration.

c. All right-of-way users shall demonstrate to the satisfaction of the City the financial capability to cover any liability that might arise out of their presence in the right-of-way. If the person is a corporation, a

CODE OF GENERAL ORDINANCES, 2021 - KENOSHA, WISCONSIN

LLC or LLP, a copy of any certificate required to be filed under Wisconsin Statutes as recorded and certified to the Secretary of State and shall be included with the registration.

d. If certified, a copy of the person's certificate of authority from PSCW or other applicable state or federal agency, where the person is lawfully required to have such certificate from said commission or other state or federal agency.

e. Execution of an indemnification agreement in a form prescribed by the Department, which is consistent with, and shall not exceed the obligations provided in, Section 5.04 V. herein.

2. Notice of Changes. The registrant shall keep all of the information listed above current at all times by providing to the Department information as to changes within fifteen (15) working days following the date on which the registrant has knowledge of any change.

3. Performance Bond Required. Every person, party, utility, firm or corporation engaged in the business of constructing, modifying, destroying, removing or repairing sidewalks or driveway approaches or excavating or opening any street or any other public way, before the issuance of the registration, shall give a surety bond to the City of Kenosha in the penal sum of Ten Thousand (\$10,000.00) Dollars, which bond shall guarantee that all work is performed in accordance with this and other Ordinances of the City of Kenosha and law, rules and regulations of the State of Wisconsin and which will indemnify the City for any damage to or obstructing of its public right-of-way, including its sanitary and storm sewers and water mains. Such bonds may be filed individually for each excavation or an annual bond may be given covering all excavation work done by the principal for one year, beginning January 1st.

4. Insurance Required.

At the time of registration, furnish a certificate of liability insurance, naming the City as an additional insured and containing a provision that the Director of Public Works must be notified twenty (20) days in advance of the effective date of any termination or cancellation thereof. The following minimum insurance coverages must be in effect and continue in effect during the term of registration.

- | | |
|---|----------------------------------|
| 1) Commercial General Liability | |
| a. Each Occurrence | \$1,000,000.00 |
| b. General Aggregate | \$2,000,000.00 |
| c. Combined Single Limit (each accident) with the following coverages | \$2,000,000.00 |
| i. Premises | |
| ii. Contractual Liability | |
| iii. Products and Completed Operations | |
| iv. Death and Personal Injury | |
| 2) Automobile Liability (any auto) | |
| a. Bodily Injury (per person) | \$1,000,000.00 |
| b. Bodily Injury (per accident) | \$2,000,000.00 |
| c. Property Damage (per accident) | \$500,000.00 |
| 3) Worker's Compensation – Statutory Limits | |
| a. Each Accident | \$100,000.00 |
| b. Disease, Each Employee | \$100,000.00 |
| c. Disease, Policy Limit | \$500,000.00 |
| 4) Umbrella Liability Coverage must be at least as broad as the underlying Commercial General Liability, Automobile Liability, Liquor Liability, Fireworks Liability, Statutory Liability and Employers Liability coverages | |
| a. Each Occurrence | \$1,000,000.00 - \$4,000,000.00* |
| b. General Aggregate | \$1,000,000.00 - \$4,000,000.00* |

The Permittee must provide Umbrella Coverage for the highest tier of work they will be performing. No permits will be issued outside of the tier approved in the registration without an updated insurance policy.

Tier 1 \$1,000,000.00 – Temporary Occupancy of Right-of-Way only (dumpster, pod, facade work, temporary road closures related to construction, landscaping or forestry, etc.)

Tier 2 \$2,000,000.00 – Occupation and Excavation of the Right-of-Way for Residential Utilities

CODE OF GENERAL ORDINANCES, 2021 - KENOSHA, WISCONSIN

Tier 3 \$4,000,000.00 – Occupation and Excavation of the Right-of-Way by Public Utilities and placement of Facilities within the Right-of-Way

F. Registration Fee.

1. **Annual Registration Fee.** Each registrant shall annually renew its registration or discontinue and properly abandon its facilities. All fees shall be paid to Public Works and all registrations shall expire on the 31st day of December each year. The Common Council, from time to time, by Resolution shall establish the registration fee in an amount sufficient to recover the costs incurred by the City for processing registrants. This fee shall be computed as the average of labor costs, indirect costs, and other costs associated with registration.

a. For poles and towers, following first time registration and the installation of the registrant's facilities approved under the appropriate Department permit and prior to the next annual registration the applicant/registrant shall provide the following for all existing poles and towers owned:

(1) Structural certification stamped by a registered professional engineer in the State of Wisconsin. Structural certification will include, but not be limited to structural sufficiency and vertical plumbness.

(2) Results from stray voltage testing.

2. **Exemption.** County shall be exempt from the annual registration fee for any facility in effect pursuant to a contract between the City and County.

G. Excavation Permit Requirement.

1. **Excavation Permit Required.** Except as otherwise provide in this chapter or other chapters of the Municipal Code, no person shall excavate, raise or lower any right-of-way or place facilities in a right-of-way without first having obtained an excavation permit from the department. Should any work be commenced prior to the issuance of a permit, the fee shall increase to five (5) times the amount of the fee established by the Common Council by Resolution.

No person shall excavate right-of-way or maintain an excavation in the right-of-way beyond the date or as specified in the permit unless such person makes a supplementary application for another excavation permit before the expiration of the initial permit, pursuant to Section 5.04 N., and a new permit or permit extension is granted.

2. **Permit Display.** A copy of any permit issued under this chapter shall be made available at all times by the Permittee at the indicated work site and shall be available for inspection by the department upon request.

H. Excavation Permit Application.

1. Application for a permit shall be made to and issued by the Department. Permit applications shall contain, and will be considered complete only upon compliance with the requirements of the following provisions:

a. Registration with the Department as required by this Chapter;

b. Submission of a completed permit application form, including the following:

(1) The applicant shall identify in detail the location of the proposed project and any affected right-of-way, public utility easements, and the location of all existing and proposed facilities within the project area in addition to installation details, traffic control plans and other details requested by the Department;

(2) If the proposed project involves the installation of a pole or tower in the right-of-way, the applicant must submit:

(a) Scaled drawings of the proposed pole or tower and all proposed attachments, stamped by a Wisconsin registered professional engineer.

(b) Structural stability certification of each individual pole or tower.

CODE OF GENERAL ORDINANCES, 2021 - KENOSHA, WISCONSIN

(c) At the discretion of the Department, the applicant may be required to provide soil testing to ensure proper soil stability.

(d) If the proposed project involves the installation of a pole or tower in the right-of-way, the applicant must submit evidence sufficient to demonstrate that the applicant is prohibited from using an existing pole or tower (either owned by the applicant or a third party) because such use is technically infeasible, economically prohibitive, or prohibited by law.

(e) If the proposed project involves the installation of a pole or tower in the right-of-way that is greater than 10 feet taller than existing poles or towers in nearby right-of-way, the applicant must submit evidence sufficient to demonstrate that: (i) the greater height is required to accomplish the applicant's purposes; (ii) the applicant is prohibited from using existing poles or towers (either owned by applicant or a third party) to accomplish its purposes because such use is technically infeasible, economically prohibitive, or prohibited by law; (iii) the pole or tower, due to its height and size, poses no greater danger to the health, safety, and welfare of the public than existing poles in nearby right-of-way; and (iv) in evaluating such circumstances, the Department may employ the services of a consulting expert, the expense for which shall be reimbursed by the applicant as an administrative cost of processing the application.

(f) If the proposed project involves the installation of a pole or tower in the right-of-way, the applicant must submit evidence to demonstrate compliance with the height limitations indicated on the City of Kenosha Airport Height Limitation Map.

c. Payment of all money due to the City for:

- (1) applicable permit fees and costs as set forth below.
- (2) unpaid fees or costs due for prior excavations; or
- (3) any loss, damage, or expense suffered by the City because of applicant's prior excavations of the rights-of-way or any emergency actions taken by the City.

d. A statement on forms provided by the Department that the registrant will comply with all local, state, and federal codes including, but not limited to, safety, building, traffic control codes, and the Manual of Uniform Traffic Control Devices (MUTCD). All work is to be done according to good engineering practice that the public safety be procured, and the street be properly restored.

e. The Department shall not deny a registrant an excavation permit because of a dispute between the City and the registrant, related to Section 5.04 H.1.c.(2) and/or Section 5.04 H.1.c.(3) if

- (1) the dispute has been adjudicated in favor of the registrant;
- (2) the dispute is the subject of an appeal filed by the registrant and no decision in the matter has at yet been rendered.

I. Excavation Permit Fee.

1. **Fee Calculation.** The excavation permit fee shall be established by the Department and shall be made payable to the City of Kenosha prior to the issuance of the permit. The Common Council will, from time to time, by resolution, establish the permit fee in an amount sufficient to recover the costs incurred by the City. This fee shall recover costs incurred by the City for each of the following categories as provided herein:

a. **Administrative and Inspection:** The general formula for computing the administrative and inspection fees shall be the average per-permit costs for labor plus indirect and other costs.

b. **Repair:** No repair fee shall be collected by the City. However, the permittee shall be required to repair the public right-of-way to Department specifications, subject to inspection and acceptance by the Department, pursuant to Section 5.04 J. below, and to pay a degradation fee.

c. **Degradation:** The general formula for computing the degradation fee shall be the cost per square yard for street, overlay and seal coat multiplied by the appropriate depreciation rate for that street multiplied by the area of the patch.

The area of the patch shall generally be square and calculated by adding two feet to each side of

CODE OF GENERAL ORDINANCES, 2021 - KENOSHA, WISCONSIN

the anticipated street cut and then, at the option of the Department, extending to the full pavement lane width. Depreciation schedules shall be provided by type of street.

The total excavation permit fee shall be calculated as follows: Total Excavation Permit Fee = Administrative and Inspection Cost + Degradation Fee.

2. Exemption. The City, the Kenosha Water Utility and their contractors shall not pay administrative and degradation fees. County shall not be required to pay administrative and degradation fees so long as such work is performed pursuant to a contract between the City and County.

3. Payment of Permit Fees. No excavation permit shall be issued without payment of applicable fees.

4. Fee Computation. The Department may recalculate and establish a new fee structure each year.

5. Non-refundable. Permit fees paid for a permit that the Department has revoked pursuant to **Section 5.04 P.** below are not refundable. If the excavation defined in the excavation permit does not proceed, upon return of the permit to the Department the degradation fee may be refunded upon approval of the Department. However, the Administrative Cost is not refundable.

J. Right-of-way Repair.

1. The work to be done under the excavation permit, and the repair of the right-of-way as required herein, must be completed within the dates specified in the permit, increased by as many days as work could not be done because of circumstances beyond the control of the Permittee or when work was prohibited as unseasonable or unreasonable under Section 5.04 P. below.

2. In addition to repairing its own work, the Permittee must repair the general area of the work, and the surrounding areas, including the paving and its foundations, to the specifications of the Department. The Department shall inspect the area of the work and accept the work when it determines that proper repair has been made, per specifications of the Department.

3. Standards. The Permittee shall perform repairs according to the specifications of the Department and/or in accordance with the conditions specified in the permit. The Department shall have the authority to prescribe the manner and extent of the repair and may do so in written procedures of general application or on a case-by-case basis.

4. Guarantees. The Permittee guarantees its work and shall maintain it for thirty-six (36) months following its completion, except for organic material, which shall be maintained for twelve (12) months. During either period, the Permittee shall, upon notification from the Department, correct all repair work to the extent necessary, using the method required by the Department. Said work shall be completed within ten (10) calendar days of the receipt of the notice from the Department, not including days during which work cannot be done because of circumstances constituting force majeure or days when work is prohibited as unseasonable or unreasonable under Sec. 16-119.

5. Failure To Repair. If the Permittee fails to repair the right-of-way in the manner and to the condition required by the Department, or fails to satisfactorily and timely complete all repair required by the Department, the Department at its option may do such work. In that event the Permittee shall pay to the City, within thirty (30) days of billing, the cost of repairing the right-of-way. If the Permittee fails to pay as required, the City may exercise its rights under the repair bond.

K. Inspection.

1. Site Inspection. The Permittee shall make the work site available to the Department and to all others as authorized by law for inspection at all reasonable times during the execution of and upon completion of the work.

2. Notices Required. The Permittee shall provide the Department with the following notices or will be subject to an administrative fee of Forty-five (\$45.00) for each notice it fails to provide:

CODE OF GENERAL ORDINANCES, 2021 - KENOSHA, WISCONSIN

a. Notice of Commencement. When work under any permit issued hereunder is commenced, the Permittee shall notify the Department.

b. Notice of Completion. When work under any permit issued hereunder is completed, the Permittee shall notify the Department.

3. Reinspection Fees. A Reinspection Fee may be assessed when any of the following occur:

a. An inspection is requested by the contractor, and the Work is not completed.

b. An inspection is requested by the contractor, and there is no access to the Site.

c. After an initial inspection and notice of violation(s) to be corrected, an inspection is requested by the Permittee to approve corrections, and those corrections are incomplete or only a portion of the corrections are made, or corrections have been ignored, and previous arrangements have not been made with the Inspector to accomplish ordered corrections in phases, a Reinspection Fee shall be imposed on the Permittee responsible for the inspection request. Work may not proceed on the Installation impacted until such time that said Reinspection Fee has been paid. There shall be no Reinspection Fee for a final inspection to determine compliance, or for a reinspection occurring during a period of an approved time extension granted for good cause and involving a good faith effort on the part of the Permittee.

i. Initial reinspection fee of Forty-five (\$45.00) may be charged for the first reinspection.

ii. A fee of Ninety (\$90.00) Dollars may be charged for a second reinspection.

iii. A fee of Three Hundred Sixty (\$360.00) Dollars may be charged for each subsequent reinspection.

4. Authority of Department. At the time of inspection, the City may order the immediate cessation of any work that poses a threat to the life, health, safety, or well-being of the public. The City may issue an order to the registrant for any work that does not conform to the applicable standards, conditions, or codes. The order shall state that failure to correct the violation will be cause for revocation of the permit. Within ten (10) days after issuance of the order, the registrant shall present proof to the Department that the violation has been corrected. If such proof has not been presented within the required time, the Department may revoke the permit pursuant to Section 5.04 P. below.

L. Fall Radius/Breakaway Requirements.

1. Poles and other utility structures over 60 feet in height shall be located so that all residential, commercial, retail, manufacturing or other occupied buildings are outside the fall radius of the structure.

2. Rigid non-breakaway poles and other above ground utility structures shall be located a minimum of 2' clear from face of roadway curbs, 2' clear from edge of sidewalk, 10' clear from edge of traveled way behind shoulders and behind existing or future sidewalks.

M. Joint Applications.

1. Joint Application. Registrants may jointly apply for permits to excavate the right-of-way at the same place and time.

2. With City Projects. Registrants who join in a scheduled excavation performed by the City, whether or not it is a joint application by two or more registrants or a single application, are not required to pay the degradation portion of the excavation permit fee.

3. Shared Fees. Registrants who apply for permits for the same excavation, which the Department does not perform, may share in the payment of the excavation permit fee. Registrants must agree among themselves as to the portion each will pay and indicate the same on their applications.

N. Supplementary Applications.

1. Limitations on Area. An excavation permit is valid only for the area of the right-of-way

CODE OF GENERAL ORDINANCES, 2021 - KENOSHA, WISCONSIN

specified in the permit. No Permittee may perform any work or excavate outside the area specified in the permit, except as provided herein. Any Permittee which determines that an area greater than that specified in the permit must be excavated shall, before working in that greater area (1) make application for a permit extension and pay any additional fees required thereby and (2) be granted a new permit or permit extension.

2. Limitation on Dates. An excavation permit is valid only for the dates specified in the permit. No Permittee may begin its work before the permit start date or, except as provided herein, continue working after the end date. If a Permittee does not finish the work by the permit end date, it must apply for a new permit for the additional time it needs and receive the new permit or an extension of the old permit before working after the end date of the previous permit.

3. Fees for Supplementary Applications. A Permittee shall pay administration and inspection fees for any additional permits. A Permittee is not required to pay an additional degradation fee for the same excavation, if such fee has already been paid on the original permit.

O. Other Obligations.

1. Compliance with Other Laws. Obtaining a permit to excavate and/or occupy the right-of-way does not relieve a Permittee of its duty to obtain all other necessary permits, licenses, and authority and to pay all fees required by any other City, county, State, or Federal rules, laws or regulations. A Permittee shall comply with all requirements of local, state, and federal laws. A Permittee shall perform all work in conformance with all applicable codes and established rules and regulations, and is responsible for all work done in the right-of-way pursuant to its permit, regardless of who does the work.

2. Prohibited Work. Except in an emergency, or with the approval of the Department, no right-of-way excavation may be done when seasonally prohibited or when conditions are unreasonable for such work.

3. Barriers and Warnings. Any person opening, excavating, or occupying any street, sidewalk or alley, shall place proper and sufficient barriers and guards about the same as outlined in the "Manual on Uniform Traffic Control Devices". Said manual is intended to be as much a part of the Ordinance as if it were printed in total. During the hours of dusk and darkness, adequate and sufficient warning lights shall be placed and maintained about the same. No person shall Interfere with or remove such barriers, guards, or lights.

4. Placement of Spoil Material. In opening any street or other public way, all paving or base material shall be removed with the least possible loss of or injury to surfacing material and, together with the excavated material from trenches, shall be placed so as to cause the least practicable inconvenience to the public and permit free flow of water along gutters.

5. Contractors Equipment and Operations. All machinery and equipment shall be locked or otherwise effectively safeguarded from unauthorized use when not being used by the permittee, his agents or employees. Except by special permission of the Director of Public Works, no trench shall be excavated more than 100 feet in advance of pipe laying, nor left unfilled more than 200 feet where pipe has been laid. When the side of the trench will not stand perpendicular, sheathing and bracing must be used to prevent caving. No timber, bracing, lagging sheathing, or other lumber shall be left in any trench. All necessary precautions shall be taken to guard the public effectively from accidents or damage to persons or property through the period of the work. Each person making such opening shall be held liable for all damages including costs incurred by the City in defending any action brought against it for damages, as well as cost of any appeal, that may result from the neglect by such persons or his employees of any necessary precaution against injury or damage to persons, vehicles, or property of anykind.

6. Backfill and Surfacing. All openings or excavations in a street shall be backfilled with sand or gravel, meeting specifications on file in the office of Public Works. The permittee shall notify the Department of Public Works prior to commencing backfilling, and shall only backfill with City Inspector approval.

When a pavement opening is made in an arterial or major street, a temporary patch shall be placed by the permittee upon completion of the backfill per specifications on file in the office of Public Works.

CODE OF GENERAL ORDINANCES, 2021 - KENOSHA, WISCONSIN

No permit for pavement or sidewalk opening shall be issued to any person if any such charge for maintenance and reconstruction work remains due and unpaid.

7. Excavations in New Streets Limited. The Common Council shall approve the permanent improvement or repaving of streets not less than 30 days before the work of permanent improvement or paving shall begin. Following such approval by the Common Council, the City Engineer shall notify in writing each person, utility, City department, or other agency owning or controlling any sewer, water main, conduit, or other utility in or under said street, of the intent of the City of Kenosha to permanently improve or repave said street, and that all excavation work in said street shall be coordinated with and scheduled by the City Engineer or their designee to obtain a reasonable completion of the work. After such permanent improvement or repaving no permit shall be issued to open, cut or excavate said street for a period of 5 years after the date of improvement, or repaving unless in the opinion of the City Engineer an emergency exists which makes it necessary that the permit be issued or the permit is necessary to facilitate a city approved development agreement. Notwithstanding the foregoing prohibition and subject to the approval of the City Engineer, upon request a portion of the curb and gutter may be temporarily removed from existing joint to existing joint to provide driveway access to any adjacent parcels of property to facilitate development of the adjacent property. Restoration of the curb and gutter shall be a condition of approval.

8. Special Conditions. Permits for street openings in "through" streets as outlined in **Section 7.03** of the Code of General Ordinances on street openings lying within 500 feet of any school, hospital, nursing home, or similar institution, may be subject to additional requirements for road closures, working conditions, etc., and the City Inspector will work with the Permittee to meet any of the additional conditions.

P. Revocations, Suspensions, Refusals To Issue or Extend Permits.

1. Grounds. The Department may refuse to issue a permit or may revoke, suspend or refuse to extend an existing permit if it finds any of the following grounds:

a. The applicant or Permittee is required by **Section 5.04 D.** to be registered and has not done so or the permit application is otherwise incomplete;

b. The applicant or Permittee is seeking to perform work not included in its construction and major maintenance plan; which work was reasonably foreseeable by the applicant or Permittee at the time said plan was filed;

c. Issuance of a permit for the requested date would or interfere with an exhibition, celebration, festival, or other event;

d. Misrepresentation of any fact by the applicant or Permittee;

e. Failure of the applicant or Permittee to maintain required bonds and/or insurance;

f. Failure of the applicant or Permittee to complete work in a timely manner;

g. The proposed activity is contrary to the public health, safety or welfare;

h. The extent to which space is available in the right-of-way for which the permit is sought;

i. The competing demands for the particular space in the right-of-way;

j. The availability of other locations in the right-of-way or in other rights-of-way for the facilities of the Permittee or applicant;

k. If the Permittee or applicant proposes to install a new pole or tower in the right-of-way, the availability of other existing poles or towers owned by the Permittee or applicant or by a third party;

l. The applicability of ordinances or other regulations of the right-of-way that affect location of facilities in the right-of-way;

m. The condition and age of the right-of-way, and whether and when it is scheduled for total or

partial reconstruction; or

n. The applicant or Permittee is otherwise not in full compliance with the requirements of this chapter or state or federal law.

o. If the applicant or Permittee has more than five (5) expired permits or permits that have not been satisfactorily completed per the City Inspector.

p. The Permittee has failed to pay any fee required by Section 5.04 K.

2. Discretionary Issuance. Notwithstanding Sub. (a)(2), the Department may issue a permit where issuance is necessary (a) to prevent substantial economic hardship to a customer of the Permittee or applicant, or (b) to allow such customer to materially improve its Public Utility service, or (c) to allow the Permittee or applicant to comply with state or federal law or City ordinance or an order of a court or administrative agency.

3. Appeals. Any person aggrieved by a decision of the Department revoking, suspending, refusing to issue or refusing to extend a permit may, within ten (10) days of the Department's decision being issued, file a written request with the Department seeking a review of the decision by the Public Works Committee. Following a hearing the Public Works Committee may affirm, reverse or modify the decision of the Department. The decision of the Public Works Committee is final.

4. Time Limit to Act And Written Denial. The City shall approve or deny a permit application no later than sixty (60) days after receipt of the application. If the City fails to act on the application within that sixty (60) day period, the application shall be deemed granted and the City shall issue the permit to Applicant. If the City denies a permit application, the City shall provide Applicant with a written explanation of the reason for the denial at the time the City denies the application. See Wis. Stat. § 182.017(9).

Q. Work Done Without a Permit.

1. Emergency Situations. In the event of an emergency, any person owning or controlling any sewer, water main, conduit or other utility in or under any street, and his agents or employees may take immediate proper emergency measures to remedy dangerous conditions for the protection of property, life, health or safety without obtaining an Excavation Permit, provided that such person shall apply for an excavation permit not later than the end of the next succeeding business day, and shall not make any permanent repairs without first obtaining an Excavation Permit hereunder. If the City becomes aware of an emergency regarding a registrant's facilities, the Department may attempt to contact the local representative of each registrant affected. The City may take whatever action it deems necessary to protect the public safety as a result of the emergency, the cost of which shall be borne by the registrant whose facilities occasioned the emergency.

2. Non-Emergency Situations. Except in an emergency, any person who, without first having obtained the necessary permit, excavates a right-of-way must subsequently register and apply for an excavation permit, and shall in addition to any penalties prescribed by ordinance, pay five times the normal fee established by the Common Council by Resolution for said permit, pay all other fees required by this chapter or other chapters of the City Code, deposit with the Department the fees necessary to correct any damage to the right-of-way and comply with all of the requirements of this chapter. If a subsequent permit is denied or is not approved, the registrant shall discontinue and abandon its facilities and the Department may cause any offending conditions to be removed or corrected and the expense thereof charged to the person responsible.

R. Supplementary Notification. If the excavation of the right-of-way begins later or ends sooner than the date given on the permit, the Permittee shall notify the Department of the accurate information as soon as this information is known.

S. Location of Facilities.

1. Undergrounding. Unless in conflict with state or federal law, except when existing aboveground facilities are used, the installation of new facilities and replacement of old existing facilities shall be done underground or contained within buildings or other structures in conformity with applicable

codes.

2. Corridors. The Department may assign specific corridors within the right-of-way, or any particular segment thereof as may be necessary, for each type of facility that is or, pursuant to current technology, the City expects will someday be located within the right-of-way. All excavation, obstruction, or other permits issued by the City involving the installation or replacement of facilities shall designate the proper corridor for the facilities at issue consistent with the Department's assignment.

Any registrant who has facilities in the right-of-way in a position at variance with the corridors established by the City shall, no later than at the time of the next reconstruction or excavation of the area where the facilities are located, move the facilities to the assigned position within the right-of-way, unless this requirement is waived by the City for good cause shown, upon consideration of such factors as the remaining economic life of the facilities, public safety, customer service needs and hardship to the registrant.

3. Limitation of Space. To protect health, safety, and welfare, or when necessary to protect the right-of-way and its current use, the Department may prohibit or limit the placement of new, replacement or additional facilities within the right-of-way if there is insufficient space to accommodate all of the requests of Utilities to occupy and use the right-of-way. In making such decisions, the Department/City shall strive to the extent possible to accommodate all existing and potential users of the right-of-way, but shall be guided primarily by considerations of the public interest, the public's needs for the particular utility service, the condition of the right-of-way, the time of year with respect to essential utilities, the protection of existing facilities in the right-of-way, and future City plans for public improvements and development projects which have been determined to be in the public interest.

T. Relocation of Facilities. Except as prohibited by State or Federal law, a registrant must promptly and at its own expense, with due regard for seasonal working conditions, permanently remove and relocate its facilities in the right-of-way whenever the Department requests such removal and relocation, and shall restore the right-of-way to the same condition it was in prior to said removal or relocation. The Department may make such request to prevent interference by the Company's facilities with (i) a present or future City use of the right-of-way, (ii) a public improvement undertaken by the City, (iii) an economic development project in which the City has an interest or investment, (iv) when the public health, safety and welfare require it, (v) when necessary to prevent interference with the safety and convenience of ordinary travel over the right-of-way, (vi) future development resulting in building(s) located within fall zones, (vii) when necessary to prevent interference with other existing communication service providers, or (viii) existence of stray voltage.

Notwithstanding the foregoing, a Utility shall not be required to remove or relocate its facilities from any right-of-way which has been vacated in favor of a non-governmental entity unless and until the reasonable costs thereof are first paid to the person therefor.

U. Interference with Other Facilities During Municipal Construction. When the City performs work in the right-of-way and finds it necessary to maintain, support, shore, or move a registrant's facilities, the City shall notify the local representative. The registrant shall meet with the City's representative within 24-hours and coordinate the protection, maintenance, supporting, and/or shoring of the registrant's facilities. The registrant shall accomplish the needed work within 72 hours, unless the City agrees to a longer period. In the event that the registrant does not proceed to maintain, support, shore, or move its facilities, the City may arrange to do the work and bill the registrant for costs it incurs as well as damages of \$100 per day beyond the registrant's 72 hour deadline to accomplish the needed work, said bill to be paid within thirty (30) days.

V. Indemnification. By registering with the City, or by accepting a permit under this chapter, a registrant or Permittee, as the case may be, agrees to indemnify, defend, and hold harmless the City, its officers, boards, committees, commissions, elected officials, employees and agents (collective, "Indemnified Parties"), from and against all loss or expense (including liability costs and attorney's fees) by reason of any claim or suit, or of liability imposed by law upon an Indemnified Party for damages because of bodily injury, including death at any time resulting therefrom, sustained by any person or persons or on account of damages to property, including loss of use thereof, arising from, in connection with, caused by or resulting from the permittee's acts or omissions in the exercise of its rights under this permit, whether caused by or contributed to by the City or its agents or employees except in such cases where caused by

the sole negligence or willful misconduct of the City.

W. Abandoned Facilities.

1. Discontinued Operations. A registrant who discontinues its operations in the City must either:

- a. Provide information satisfactory to the Department that the registrant's obligations for its facilities under this chapter have been lawfully assumed by another registrant; or
 - b. Submit to the Department a proposal and instruments for dedication of its facilities to the City.
- If a registrant proceeds under this clause, the City may, at its option:

- (1) accept the dedication for all or a portion of the facilities; or
- (2) require the registrant, at its own expense, to remove the facilities in the right-of-way at ground or aboveground; or
- (3) require the registrant to post a bond or provide payment sufficient to reimburse the City for reasonably anticipated costs to be incurred in removing the facilities.

However, any registrant who has unusable and abandoned facilities in any right-of-way shall remove it from the right-of-way within two years, unless the Department waives this requirement.

2. Abandoned Facilities. Facilities of a registrant who fails to comply with **Section 5.04 W.1.**, and which, for two (2) years, remains unused shall be deemed to be abandoned. Abandoned facilities are deemed to be a nuisance. In addition to any remedies or rights it has at law or in equity, the City may, at its option (i) abate the nuisance, (ii) take possession of the facilities, and/or (iii) require removal of the facilities by the registrant, or the registrant's successor in interest.

3. Public Utilities. This section shall not apply to a Public Utility that is required to follow the provisions of Wis. Stat. § 196.81.

X. Reservation of Regulatory and Police Powers. The City, by granting of a permit to excavate, obstruct and/or occupy the right-of-way, or by registering a person under this chapter does not surrender or to any extent lose, waive, impair, or the lawful powers and rights, which it has now or maybe hereafter granted to the City under the Constitution and statutes of the State of Wisconsin to regulate the use of the right-of-way by the Permittee; and the Permittee by its acceptance of a permit to excavate, obstruct and/or occupy the right-of-way or of registration under this chapter agrees that all lawful powers an rights, regulatory power, or police power, or otherwise as are or the same may be from time to time vested in or reserved to the City, shall be in full force and effect and subject to the exercise thereof by the City at any time. A Permittee or registrant is deemed to acknowledge that its rights are subject to the regulatory and police powers of the City to adopt and enforce general ordinances necessary to the safety and welfare of the public and is deemed to agree to comply with all applicable general law, and ordinances enacted by the City pursuant to such powers.

Y. Obstructions and Encroachments.

1. Short Duration Street Closure. No person, firm or corporation shall encroach upon or encumber any public street, highway or part thereof, unless expressly authorized to do so by the Department. Application for said permission shall be made in writing to the Department of Public Works and the type plans, etc. of said obstruction or encroachment shall be submitted to the Director of the Department of Public Works, and the Fire and Police Departments for review and recommendation. The purposes for such encroachment, closure, or encumbrance include, but are not limited to, facilitating the passage of a wide or hazardous transportation load, addressing an emergency, facilitating fire-fighting training exercises, allowing for passage of a police escorted motorcade, an Open Container Entertainment Event, a Farmer's Market or allowing for a civic event, with a duration of less than sixty minutes to which the general public is encouraged to attend.

2. Street Party.

a. Definitions.

- (1) "Street" for purposes of this paragraph 5.04 B. 2, means that section and/or portion of a public thoroughfare sought to be closed for a Street Party.
- (2) "Street Party" is defined as a gathering of persons for a civil, charitable, community or

neighborhood event held within a Street in a residentially zoned district which has been temporarily closed for the occasion, to which the general public is not solicited or otherwise encouraged to attend.

b. Authorization. The Department may order the temporary closing of a City Street in a residentially zoned district for the purpose of authorizing a Street Party to be held thereon, through the issuance of a "Street Party Permit". Such authorization may not be for an arterial or collector street.

c. Application. The request for a Street Party Permit must be in writing, signed by a majority of property owners fronting the street to be closed, filed at least ten (10) business days in advance of the event desired to be held, and accompanied by a fee to cover the cost of permit issuance and administration. The Common Council will, from time to time, by Resolution, establish the Permit Fee.

d. Penalty. Should any Street Party take place prior to the issuance of a permit, the Permit Fee shall increase to five (5) times the amount of the Permit Fee established by the Common Council by Resolution.

e. Limit. There shall be a limit of two (2) permits per calendar year per street.

f. Procedure. The Department of Public Works shall inspect the Street and obtain the recommendations of the Fire and Police Departments prior to permit issuance. The Department of Public Works shall provide barricades to close off the Street which will be the subject of the Street Party. The Department may decline to grant said permit for good cause, such as, but not limited to, his/her consideration that the street closing, if permitted, will, or will tend to cause unreasonable traffic congestion, result in a disturbance of the peace, or endanger the public health, safety and welfare. The Department, upon granting a permit, shall send notice of same to the Fire and Police Departments, notifying the departments of a closed street. The permit shall be issued by the City Public Works Department after the granting of the permit by the Department. The permit shall state the time and location for which the permit is valid and the Police Department shall check the Street during said permit hours to determine if the barricades have in fact been put in place. It shall be the responsibility of the applicant to put in place and maintain said barricades during the hours of the street closing specified on said permit. It shall be unlawful to hold a Street Party under circumstances where barricades do not completely block off vehicular traffic from the portion of the Street being closed by authority of said permit. If the street is barricaded during hours which require vehicles to use their headlights, warning lights or reflectors must be clearly and visibly placed and maintained on said barricades by the permit applicant, and it shall be unlawful to neglect to have operating lights or reflectors on said barricades. Lights and reflectors shall be supplied by the Department of Public Works to the applicants upon request. It shall also be unlawful to place or maintain said barricades on a city street or public thoroughfare at any time or location not specified in said permit application. The applicant shall at all times be personally responsible for complying with this Ordinance and his/her duties are not delegable. It shall further be unlawful for any person to possess a City barricade or use the same for any purpose not authorized by the City. Permits issued by the Department shall state a starting time and termination time. Street Parties shall start no earlier than 10:00 A.M. Street Parties shall terminate no later than 11:00 P.M., however, the Department, upon the request of abutting property owners, may specify an earlier termination time. Prior to granting a permit, the Department should confer with the Alderperson of the District, if practicable. Amplified noise or music is prohibited unless specifically authorized. Amplified music is herein defined as music electrically or mechanically enhanced by an external source of power or amplifier and played or reproduced through a speaker or speaker system. Street Parties may be prematurely terminated by order of a police officer following an investigation which indicates that the Street Party has become loud, disorderly, is creating a public nuisance, disturbing the peace, endangering the public health, safety or welfare, or otherwise being conducted contrary to the terms of this Ordinance or other City or State ordinances, laws, rules or regulations. It shall be unlawful for anyone to participate in a Street Party contrary to an above provided for order of a police officer or contrary to the terms of this Ordinance.

g. Denial. Should the permit be denied and the applicant does not appeal the denial, the full application fee shall be refunded to the Applicant.

h. Appeal. Should the permit be denied, the applicant may appeal the denial to the Committee on Public Works by filing a written notice of appeal with the Department of Public Works within five (5) business days following, but not including, the day of denial.

3. Special Event. No person may open, maintain, operate, or participate in a Special Event as defined by 12.06 of the Ordinances, except pursuant to a permit therefor that has been secured for the location upon which the Special Event is opened, maintained, or operated.

4. Areaways, Vaults, Etc. No areaway, vault, coal shoot, basement steps, grating, rail, retaining wall, or other similar structure shall be constructed or maintained in any street without permit from the Department. The Department shall impose such conditions in the permit as to safeguard the public in the

construction and maintenance of the encroachment. The fee for such permit shall be \$15. If the construction becomes unsafe in the opinion of the Department, he or she may order the same removed or repaired within 10 days. If the condition remains unremedied after that time, the City may do what is necessary and place the cost thereof on the tax roll against the owner of the abutting property.

5. Temporary Street Closures. The Department may temporarily close any portion of any City controlled public thoroughfare for public safety or welfare purposes upon such conditions as the Department deems necessary in the exercise of his or her discretion. The temporary closure may not exceed thirty continuous days, unless the Department deems that there are extraordinary circumstances warranting additional closure beyond the thirty days.

Z. Miscellaneous.

1. Streets Closed to Travel, Protection of New Concrete.

a. Whenever any street or alley is impassable or unsafe for travel or during the construction or repair of any such street or alley and until it is ready for travel, the Department of Public Works may keep it closed by maintaining barriers at each end of the closed portion. The barriers shall be of such material and construction and placed in accordance with the manual as to indicate that the street or alley is closed and shall be lighted at night.

b. No person, without lawful authority, shall remove, take down, alter the position of, destroy, pass over or beyond any barrier so erected, or travel with any vehicle upon any portion of any street or alley closed by barriers as provided above. No person shall walk or travel in any manner upon the materials placed on any street or alley as part of the repair or construction work.

2. Deposit of Dirt onto Streets. No operator of any vehicle shall cause, allow or permit such vehicle to drop, deposit or track any mud or dirt from a construction site onto any street. The Department of Public Works shall give the contractor whose vehicle violates this prohibition twenty-four (24) hours to clean any such street. If the contractor fails to comply with the notice, the Department of Public Works shall clean any such street and report the itemized cost thereof to the City Attorney who shall take appropriate action to collect such cost. If the presence of such dirt or mud on any street constitutes in the judgment of the Director of Public Works an immediate traffic hazard he shall, without notice to the contractor, immediately clean such street and the cost therefor shall be collected as aforesaid. No person, firm or corporation, shall deposit rubbish or wastes in any highway.

3. Covers--Grates--Doors. No person, firm or corporation shall keep open and unattended or unguarded any opening in any street, sidewalk or alley. No person, firm or corporation shall remove or impair any covers, grates or doors in any street, sidewalk or alley.

4. Fences. No person, firm, or corporation shall construct or maintain any barbwire fence in any street or sidewalk area, or within two feet thereof.

5. Bills or Notices. Without the specific permission of the Common Council, no person, firm or corporation shall post bills or notices in any street right-of-way, or attach any object or thing whatsoever on utility poles.

6. Lighting and Paving of Alleys.

a. Lighting and paving of alleys shall, in all instances, be done at the sole discretion of the Common Council.

b. The cost of paving alleys shall be spread as a special assessment upon the abutting benefiting properties on the same basis as street paving. Said special assessment shall be reduced by twenty-five (25%) percent, which cost shall be assumed by the City.

c. Alley lighting costs shall be totally paid for by the City.

7. Partial Alley Vacations. Alleys shall be vacated in accordance with Section 66.1003, Wisconsin Statutes. A partial vacation of an alley will be approved by the Common Council subject to the

following:

a. **Criteria.**

(1) The length of the alley remaining upon vacation of a portion of said alley shall not exceed one hundred (100') feet or abut more than four (4) properties.

(2) The partial alley vacation shall not result in discontinuance of sole access to a developed property.

b. **Exceptions.**

(1) A partial alley vacation of any length may be approved if the purpose is to reduce the length of an existing dead end alley.

(2) A partial alley vacation of any length may be approved if the result is an alley with two or more access points on a public street.

(3) A partial alley vacation contrary to the restrictions of subparagraph 7.a.(1) may be approved for good cause.

c. **Administrative Review.** Notwithstanding compliance with Sections 5.04 Z.7.a. and b., a partial alley vacation shall be denied if in the opinion of the Chief of Police, Fire Chief, Director of Public Works or Director of City Development, the proposal will adversely impact the public health or safety of the immediate neighborhood.

AA. Severability. If any section, subsection, sentence, clause, phrase, or portion of this article is for any reason held invalid or constitutional by any court or administrative agency of competent jurisdiction, such portion shall be deemed a separate, distinct, and independent provision and such holding shall not affect the validity of the remaining portions thereof.

5.041 HONORARY STREET SUBNAMES

A. **Definitions.** The following terms shall have the meanings provided below:

1. **Petitioner.** Petitioner means the person, group, institution, organization or other entity that requests an honorary street subname.

2. **Street.** Street means every highway within the corporate limits of the City, except alleys.

B. **Petition Procedure.**

1. **Petition.** The Petitioners for an honorary street subname sign must utilize forms provided by the City for that purpose. A petition for an honorary street subname sign must be countersigned by the Mayor or an Alderperson of any District that includes that specific portion of the street that is subject to a street subnaming petition, who thereby will be the sponsor of a Resolution to effectuate the street subnaming. The Petition, with countersignature, must be filed with the Office of the City Clerk/Treasurer. The City Clerk/Treasurer will not accept a petition for street subnaming unless Petitioner has included the fee to cover manufacturing of the signs(s), installation, maintenance for the possible three (3) years that the sign is in place, and administrative costs, which fee shall be as established by the Common Council, from time to time, by Resolution. Such fee is nonrefundable.

2. **Approval.** After the Petition and the related fee are filed with the City Clerk/Treasurer, if the petition is determined by the City Attorney to be in procedural and substantive compliance with the requirements of this Ordinance, the City Attorney shall prepare a Resolution for proposed action by the Common Council to effectuate such subnaming. The Resolution shall designate the times and places subnaming signs shall be placed. Once drafted by the City Attorney and approved by the sponsor, the Resolution shall be placed on the Common Council agenda for referral to the Public Works Committee for recommendation. Approval of the Resolution by the Common Council must be by majority vote of those present.

C. **Requirements/Criteria.** Approval, installation and maintenance of the subnaming sign is subject to the following requirements:

CODE OF GENERAL ORDINANCES, 2021 - KENOSHA, WISCONSIN

1. An honorary street subname shall not change the official name of any portion of the affected street.
2. Signs indicating an honorary street subname shall include the word Honorary prominently displayed before the honorary street subname.
3. Honorary street subname signs shall not use the same color scheme, font and/or size as official street name signs.
4. No person, group, institution, organization, event or other entity shall be honored by more than one(1) designation of an honorary street subname.
5. No portion of any street shall be designated with more than one (1) honorary street subname.
6. The length of the portion of the street subject to subnaming shall be determined by the Common Council in the exercise of its discretion, which length may be less than that requested on the petition, but in no event may it be greater than ten (10) City blocks.
7. Honorary street subname signs shall be posted only at both ends of the street to be subnamed at the intersecting cross street(s), and no intersection shall include more than two (2) signs indicating an honorary street subname. Honorary street subnames shall not apply to any portion of a street longer than ten (10) City blocks.

D. Duration. No honorary street subname sign shall be in place for a period exceeding three (3) years from the date of approval installation. The Common Council, upon recommendation from the Public Works Committee shall have the ability to authorize the removal of an honorary street subname when it is determined that such honorary street subname no longer is relevant to any person, group, institution, organization, event or other entity for which the honorary street subname was applied to.

E. Restriction. Honorary street subnames may not be of individuals unless deceased for a minimum period of three (3) years. Restriction shall not apply to Mayor or Aldermanic sponsorship.

5.045 BANNERS, SIGNS, DECORATIONS AND OBSTRUCTIONS IN PUBLIC RIGHT-OF-WAY

A. Permit Required. No person, party, firm or corporation shall place any banner, sign, decoration, or obstruction in any public right-of-way without first obtaining the written permission of the Director of Public Works. The Common Council shall, from time to time, by Resolution, establish permit fees.

B. Exception and Limitation. The requirements of this Ordinance do not apply to:

1. The placement of banners, signs, decorations or obstructions by the City in a right-of-way; and,
2. Outdoor dining areas permitted under Section 5.046 of the Code of General Ordinances.

C. Requirements. A permit under Subsection A. may be granted only where:

1. A City authorized application form has been fully completed, properly executed and filed with the Office of the City Clerk. The City Clerk shall forward said application to the Director of Public Works, or designee thereof, for review and written comment prior to placing the application on the agenda of the Committee on Public Safety and Welfare for action thereon. The application form shall include an indemnity and hold harmless agreement drafted by the City Attorney which protects the City and its officers and employees from liability arising out of acts or omissions herein relevant, and it shall also require the following information: Name of applicant; address of applicant; identification of whether applicant is a partnership, individual, corporation, group of individuals, religious organization, political organization, social organization or fraternal organization; person representing applicant to contact; location, size, construction and height of banner, sign, decoration or obstruction; when banner, sign, decoration will be put up and taken down, if temporary in nature; whether or not lighted; and a picture, diagram or sketch of banner, sign, decoration, or obstruction.

2. The applicant has procured and maintains during the permit period, a minimum liability and contractual liability insurance policy in the amount of One Million (\$1,000,000.00) Dollars single limits, providing coverage for claims involving death, personal injury and property damage. A certificate of such insurance shall be filed with the City Clerk as part of the application. If a sign or decoration is painted upon the property of another which lawfully infringes on a public right-of-way, this requirement shall apply only to the painter during the period of painting. The City Attorney may recommend, and the Committee on Public Safety & Welfare may approve, higher limits of insurance protection on a case by case basis.

3. The written permission of the owner of private property which lawfully infringes on a public right-of-way, such as a railroad bridge, upon which the banner, sign, decoration or obstruction will be placed, has been procured and attached to the application. Banners, signs, decorations and obstructions may not be placed on private property which unlawfully infringes on a public right-of-way.

4. The persons executing the application are authorized to do so by the corporation, partnership or organization in whose name the permission is requested and the application must document said authorization.

5. The placement, maintenance and removal of all banners, signs, decorations or obstructions shall be by applicant, solely at applicant's expense.

6. It shall be unlawful for any applicant obtaining a permit hereunder to fail to promptly remove a banner, sign, decoration or obstruction by the date specified within their application for taking it down, or by such other date as is determined by the Committee on Public Safety & Welfare.

D. Conditions of Approval. The Committee on Public Safety and Welfare may impose reasonable permit conditions.

The following guidelines shall be used to determine conditions of approval with respect to obstructions in any public right-of-way relative to outdoor displays or sales tables or racks where otherwise permitted:

1. Placement of obstructions shall be limited to areas where the sidewalk width is twelve (12') feet wide from face of curb to building line.

2. The obstruction shall be no closer than two (2') feet to the face of the curb.

3. The obstruction shall occupy no more than five (5') feet of the area between the curb and building line.

4. Portable obstructions shall be adequately secured and anchored so as to prevent them from tipping over from the wind. Table umbrellas shall be secured with a heavy ballast holder.

5. Obstructions greater than three and one-half (3.5') feet in height shall be at least fifteen (15') feet from a corner sidewalk.

6. Obstructions cannot extend beyond the limits of the applicant's property's street frontage.

7. Aisleways to building doors will be unobstructed so as to ensure a safe fire exit.

8. In accordance with Chapter 32, Rule 06-25 of the Code of General Ordinances, no structure, tree, pole, post, sign or any other obstruction shall be placed, located or maintained within a five (5') foot radius of any fire hydrant connected to the Water Utility water supply system.

E. Prohibited Content. No banner, sign, decoration or obstruction may be obscene or may tend to discriminate against any person or group protected by law against discrimination.

F. Lighting. The lighting of banners, signs, decorations and obstructions shall be prohibited, unless specified in the application and approved by the Committee on Public Safety & Welfare. Such

approval may be granted only if the lighting will not unreasonably interfere with traffic or the peaceful use of property owners and users within the immediate vicinity thereof.

G. Appeal. Should the Committee on Public Safety & Welfare deny the application, applicant, by filing a written notice of appeal with the City Clerk within five (5) business days following, but not including, the day of denial, may appeal said denial to the Common Council. The appeal will be heard at a scheduled Common Council meeting as soon as practicable. However, to be heard at a given Common Council meeting, the notice of appeal must be filed a minimum of two (2) business days prior to said meeting, not including the day of the scheduled meeting.

H. Revocation, Suspension and Removal. The Committee on Public Safety & Welfare may suspend or revoke any permit issued hereunder and order the removal of any banner, sign, decoration or obstruction placed in a City right-of-way contrary to the terms of a permit issued under this Ordinance, or contrary to this Ordinance, upon providing permit holder with a reasonable time, not to exceed ten (10) days, in which to file a written request with the City Clerk to be heard in said matter, and show cause why the proposed action should not be taken. However, a banner, sign, decoration or obstruction may be removed without prior notice or opportunity to be heard where it constitutes an immediate danger to the public health, safety or welfare, where it is not in conformance with representations made in the application, where the Certificate of Insurance has expired or where placed within any right-of-way without a permit, contrary to the provisions of this Ordinance. In such cases, an opportunity for a post-removal hearing shall be provided.

I. Other Codes, Permits and Inspections. Permits issued hereunder are conditioned upon compliance with any Building, Health, Fire or Zoning Codes and permits and inspections hereunder, which may be applicable.

J. Penalty. Any person, party, firm or corporation who violates any provision of this Ordinance shall, upon conviction, forfeit not more than Three Hundred (\$300.00) Dollars, plus the cost of prosecution, and in the event of the failure to promptly pay said amounts, the violator shall be imprisoned for not more than ten (10) days in the County Jail. Each day of violation shall be deemed a separate offense.

5.046 OUTDOOR DINING AREA LOCATED IN A PUBLIC RIGHT-OF-WAY, MAJOR STREET SETBACK AREA OR ON PUBLIC PROPERTY

A. Definitions. The following terms and phrases, for purposes of this Ordinance, shall have the meanings provided.

1. **"Alcohol Beverages"** shall mean intoxicating liquor, wine and/or fermented malt beverages.
2. **"Applicant"** shall mean a tenant or property owner who is applying for a new or renewal permit to operate an Outdoor Dining Area in a public right-of-way, in a major street setback area, or on public property.
3. **"Dining Appurtenance(s)"** shall mean tables, chairs, planters, barriers, railings, walls, signs, benches, waste receptacles, umbrellas and heaters.
4. **"Major Street Setback Area"** shall mean the area between the property line and major "Street Setback" line as defined in Section 12.0 and established in Section 5.0 of the Zoning Ordinance for the City of Kenosha, Wisconsin.
5. **"Outdoor Dining"** shall mean the consumption of food and/or beverages in an Outdoor Dining Area.
6. **"Outdoor Dining Area"** shall mean a designated area where Dining Appurtenances are located on a sidewalk within a public right-of-way, partially within the public right-of-way and partially upon private property within the Major Street Setback Area, and/or upon public property, and operated as an integral part of an adjacent business, such as a bakery, candy and ice cream store, coffee shop, food store, grocery, delicatessen or restaurant, for the purpose of Outdoor Dining.
7. **"Pedestrian Path"** shall mean a continuous, obstruction-free sidewalk area, between the outside boundary of the Outdoor Dining Area and any obstruction. Obstructions include, but are not

CODE OF GENERAL ORDINANCES, 2021 - KENOSHA, WISCONSIN

limited to, street trees, landscaping, street lights, benches, fire hydrants, utility boxes, utility poles, bus stops, public art and waste receptacles.

8. "Permanent Improvements" shall mean privately owned improvements and/or personal property attached to the ground by cement footings, bolts or similar attachment device.

9. "Public Property" shall mean a parcel of property owned, leased or otherwise controlled by the City of Kenosha, or subunit thereof, excluding the publicly held rights-of-way.

10. "Restaurant" shall mean any building or room where, as the establishment's primary business, food and/or beverages are prepared, or served or sold to transients or the general public, and where the sale of Alcohol Beverages account for less than fifty (50%) percent of the establishment's gross receipts in the B-1, B-2, B-3 or B-4 Zoning Districts.

B. Permit Required. No person, party, firm or corporation shall be permitted to use the public right-of-way, a Major Street Setback Area or Public Property for an Outdoor Dining Area without first obtaining a permit from the Committee on Licenses/Permits. Any expansion or change in ownership of the business adjacent to the Outdoor Dining Area shall require a new application, fee, review and approval.

C. Application. A City authorized application form shall be fully completed, properly executed and filed with the City Clerk/Treasurer. An Outdoor Extension of Retail "Class B", Class "B" and/or Class "C" License and/or an Encroachment Agreement shall require separate application and approval by the Common Council.

1. The application form shall include:

a. Name, address and phone number of Applicant(s).

b. Name, address and phone number of adjacent business under Section 2.a.

c. Whether the Outdoor Dining Area is the subject of Permanent Improvements.

d. Nature of business.

e. Maximum number of tables and chairs.

f. Zoning District.

g. Indemnity and Hold Harmless Agreement indicating the Applicant(s), in consideration of having received an Outdoor Dining Area Permit, agrees to indemnify and hold harmless the City of Kenosha, Wisconsin, and its officers, employees and agents against any and all losses, claims, damages, costs, expenses, judgments, awards, attorney fees, or settlements which they may incur as a result of the use of the public right-of-way, a Major Street Setback Area or Public Property for an Outdoor Dining Area.

2. Additionally, the following items shall also be required to be submitted with the application:

a. Where an Outdoor Dining Area extends beyond the frontage of the Applicant's business, a written statement signed by the owner(s) and the tenant(s) of an adjacent business fronting the street approving the placement of the Outdoor Dining Area in front of their business.

b. An Operational Plan, including: hours, days and months of operation; planned capacity of Outdoor Dining Area; indication if Alcohol Beverages will be served in Outdoor Dining Area; and, a lighting and signage plan.

c. A scaled Site Plan indicating: the location and boundary of the proposed Outdoor Dining Area; the dimension of the remaining width of the sidewalk outside the Outdoor Dining Area; the dimension from the Outdoor Dining Area to the curb or property line and all buildings; and, the location of awnings, and Dining Appurtenances within the Outdoor Dining Area. The plans shall also indicate: existing property lines; associated building(s) and entrance(s); adjacent building(s) and entrance(s); extent of sidewalk adjacent to business(es), face of curb, location of fire hydrants, bus shelters and/or stops, trees, planters, utility poles, signs, benches, light poles, waste receptacles, driveways, alleys, vaults and any other obstructions within the public right-of-way at proposed location of Outdoor Dining Area and for an additional twenty (20') feet extending therefrom.

d. Photograph(s), a minimum of four (4") by six (6") inches, showing the entire sidewalk, Major Street Setback Area, and/or Public Property with building facade proposed for the Outdoor Dining Area.

e. Certificate of Liability Insurance, with Contractual Liability Endorsement, showing insurance in force and effect in the minimum amount of One Million (\$1,000,000.00) Dollar single limits, providing coverage for claims involving death, personal injury and property damage. The City of Kenosha shall be a named additional insured under the terms of this policy.

f. An affidavit verifying the percentage of gross receipts from the sale of Alcohol Beverages during the past City license year (July 1 to June 30), where applicable. The affidavit shall be verified under

CODE OF GENERAL ORDINANCES, 2021 - KENOSHA, WISCONSIN

oath in a statement provided by an accountant or bookkeeper.

- g.** Where permanent improvements are proposed, their specifications shall be attached.

D. Review and Approval. The City Clerk/Treasurer shall send the application to the Department of City Development, who shall forward a copy of the application to appropriate departments for review and written comment. Following the review period, the Department of City Development shall send a copy of the application and comments from City departments to the City Clerk/Treasurer to be forwarded to the Committee on Licenses/Permits. The permit may be subject to reasonable terms and conditions.

Upon initial application and renewal of an Outdoor Dining Area Permit, an Applicant that proposes to serve Alcohol Beverages shall not have their application approved when the Applicant's business has accumulated fifty (50) or more demerit points under Section 10.063 D. of the Code of General Ordinances.

E. Fee. The fee for an Outdoor Dining Area Permit shall be paid to the City Clerk/Treasurer at the time of application submission. There shall be an initial review fee of Fifty (\$50.00) Dollars. In addition, there shall be an annual permit fee of One Hundred (\$100.00) Dollars for the permit term. There shall be an initial review fee for an Outdoor Extension of a "Class B", Class "B" or "Class C" License of One Hundred Fifty (\$150.00) Dollars. Payment of the one time processing fee for such Outdoor Extension under Section 10.075 G. of the Code of General Ordinances shall satisfy this requirement. In addition, there shall be an annual renewal permit fee of One Hundred Fifty (\$150.00) Dollars for the permit term. Requests for renewals shall be made before the expiration of the existing permit. Expired Outdoor Dining Area Permits are not subject to renewal.

- F. Term.** The permit term shall be from January 1 through December 31.

- G. Transfer/Assignment.** Permits shall not be transferrable or assignable.

H. Renewal Application. The Applicant shall, on an annual basis, file a City authorized renewal application with the City Clerk/Treasurer prior to the term expiration. The following items shall be filed with the renewal form:

1. The annual renewal fee.
2. A valid Certificate of Liability Insurance.
3. An affidavit verifying percentage of gross receipts from Alcohol Beverage sales during the past City license year (July 1 to June 30). The affidavit shall be verified under oath in a statement provided by an accountant or bookkeeper.

Permits recommended for renewal shall be renewed by the City Clerk/Treasurer, upon satisfactory submittal of all required items.

I. Renewal, Nonrenewal, Revocation or Suspension. The City Clerk/Treasurer shall, on an annual basis, notify the Department of City Development by November 1 and supply a list of current Outdoor Dining Area Permits. The Department of City Development shall, within ten (10) business days, provide written comments on the type and number of violations issued to the permit holder through written orders during the previous year, if any, and a recommendation if the permit should be renewed.

The City Clerk/Treasurer shall verify the number of demerit points the Applicant's business has accumulated under Section 10.063 D. of the Code of General Ordinances at the time of renewal, if applicable. Businesses that have accumulated fifty (50) or more demerit points at the time of renewal shall be subject to suspension or revocation of an Outdoor Dining Area Permit. Recommendation for nonrenewal, revocation or suspension shall be forwarded to the Committee on Licenses/Permits for action, at any time, following a hearing. The determination of the Committee may be appealed to the Common Council by filing a notice of appeal with the City Clerk/Treasurer within ten (10) days of the date of the hearing determination.

- J. Conditions of Issuance of Permit.**

- 1. Design Regulations.**

a. A clear, continuous Pedestrian Path, parallel to the curb or adjacent property line, and not less than four (4') feet in width, shall be required for pedestrian circulation outside of the Outdoor Dining Area,

CODE OF GENERAL ORDINANCES, 2021 - KENOSHA, WISCONSIN

except where a reduction is permitted under Section P. In areas of heavy pedestrian traffic, a width greater than four (4') feet may be required. The Pedestrian Path may not be required for Public Property.

b. All Dining Appurtenances located in an Outdoor Dining Area shall not be permanently attached to any sidewalk, curb, building, tree, post, public bench, waste receptacle or any other fixture within the public right-of-way. Dining Appurtenances may be permanently attached when approved as a Permanent Improvement in the Outdoor Dining Area.

c. Fixed or retractable awnings in compliance with Section 15.06 F. of the Zoning Ordinance are permitted over Outdoor Dining Areas.

d. One (1) portable menu board sign is permitted within the Outdoor Dining Area, as permitted under Section 15.10 of the Code of General Ordinances. Signs shall be no larger than four (4) square feet in area. All proposed signs shall be shown in the application and shall be removed from the public right-of-way at the close of business each night.

e. A barrier may be permitted to enclose Outdoor Dining Areas, provided it shall not be less than thirty (30") inches and not more than forty-two (42") inches high. Barriers may be constructed of wrought iron, wood, pvc or metal railings, fences, planters, stanchions or similar products. In no case shall barriers or their support legs be located within the Pedestrian Path.

2. Location Regulations.

a. Locations of Outdoor Dining Areas shall be limited to areas where the sidewalk pavement width within the public right-of-way is at least ten (10') feet from the face of the curb to the building or property line, except where a reduction is permitted under Section P. A sidewalk partially located within the Major Street Setback Area or upon private property adjacent to the public right-of-way, may be counted toward the minimum ten (10') foot sidewalk width provided the required Pedestrian Path shall be entirely located within the public right-of-way.

b. An Outdoor Dining Area may be located directly adjacent to and abutting the associated food serving establishment, and/or located where it abuts the curb and is at least two (2') feet from the face of the curb. Outdoor Dining Areas located adjacent to an approved loading zone shall not be required to be located two (2') feet from the face of the curb. In no case shall the Pedestrian Path be reduced to less than a minimum width of four (4') feet, except where a reduction is permitted under Section P.

c. The Outdoor Dining Area may not include within its boundaries bus stops, fire hydrants or other facilities deemed necessary for public safety.

d. An Outdoor Dining Area shall be located at least five (5') feet from fire hydrants, driveways, alleys, bus shelters and/or stops. In no case shall Dining Appurtenances greater than three (3') feet in height be located within the fifteen (15') foot vision clearance triangle required under Section 2.06 of the Zoning Ordinance for the City of Kenosha, Wisconsin.

3. Operational Regulations.

a. An Outdoor Dining Area shall be an accessory use located adjacent to a bakery, candy and ice cream store, coffee shop, food store, grocery, delicatessen or restaurant, and may extend in front of of an adjacent business as permitted under Section C.2.a.

b. All Dining Appurtenances shall be movable, unless approved as a Permanent Improvement, and arranged to adequately accommodate persons with disabilities. Dining Appurtenances shall not impede building ingress and egress or encroach into the Pedestrian Path at any time. A clear area shall be maintained from all building entrances located adjacent to an Outdoor Dining Area to the Pedestrian Path. The clear area shall have a minimum width of three (3') feet or a width equal to the width of the entrance, whichever is greater. Dining Appurtenances shall be permitted to remain within the Outdoor Dining Area at the close of business each day, unless determined to be a public safety hazard.

c. Umbrellas shall have a vertical clearance of at least seven (7') feet, and be adequately secured and anchored with a heavy ballast holder to prevent displacement by the wind.

d. Amplified music or sound may be permitted in the Outdoor Dining Area only subject to strict compliance with Chapter XXIII of the Code of General Ordinances entitled "Noise Control" and the following operational hours:

1. 10:00 A.M. to 10:00 P.M. where the Outdoor Dining Area has a boundary within seven hundred fifty feet (750') of any residentially zoned property.

2. 10:00 A.M. to 1:00 A.M. where the Outdoor Dining Area's boundaries are greater than seven hundred fifty feet (750') of any residentially zoned property.

e. Cabaret and Public Entertainment licensed activities are prohibited.

f. Outdoor Dining Areas shall provide adequate lighting in and around the designated area(s) at all times. Lighting fixtures shall be limited to fixtures attached to the building facade or upon private property.

CODE OF GENERAL ORDINANCES, 2021 - KENOSHA, WISCONSIN

Battery operated lamps or candles placed on tables are permitted. Lighting shall not be a public or private nuisance.

g. Portable propane heaters are permitted within the Outdoor Dining Area provided they are a minimum of eighty (80') inches in height and located at least five (5') feet from a building.

h. Electrical and propane infrared heaters, or similar heating devices approved for outdoor use, are permitted to be attached to building facades and shall be installed according to the manufacturer's specifications and appropriate Building, Electrical and Mechanical Codes.

i. Outdoor Dining Areas that propose to serve Alcohol Beverages shall require Common Council approval of an outdoor extension of the License, prior to issuance of a permit for an Outdoor Dining Area.

j. All food and drink preparation shall be performed in the affiliated business. No food or drink preparation or storage shall be permitted within the Outdoor Dining Area.

k. Outdoor Dining Areas permitted to sell/serve Alcohol Beverages under **Section 10.075** of the Code of General Ordinances, shall limit the hours of the sale/service of Alcohol Beverages to the hours permitted in said Ordinance.

l. Operating hours for Outdoor Dining Areas shall be consistent with the operating hours of the associated business, unless the affiliated business is located adjacent to a residential zoning district, in which case Outdoor Dining Areas shall not be operated between the hours of 10 P.M. and 7 A.M.

m. Outdoor Dining in Outdoor Dining Areas shall be limited to the designated area(s) identified on the approved application.

n. The sidewalk area within and immediately surrounding the designated Outdoor Dining Area shall be maintained in a clean, sanitary, neat and orderly appearance at all times. Litter shall be removed by the permit holder on a periodic basis during the day and at the close of business each day.

o. Outdoor Dining Areas and Dining Appurtenances shall be permitted to occupy sidewalks within the public right-of-way throughout the year; provided, however, snow and ice removal shall be the obligation and at the expense of the permit holder.

p. The approval of an Outdoor Dining Area shall not be construed or deemed to create a vested interest in the public right-of-way, a Major Street Setback Area or on Public Property. The permit holder shall remove or modify an Outdoor Dining Area at their own expense whenever the City determines it necessary or desirable to modify the width of the street and/or public sidewalk, or to vacate Public Property.

K. Permanent Improvements In An Outdoor Dining Areas. Permanent improvements in an Outdoor Dining Area shall, in addition to the Outdoor Dining Area Permit, require a Street Encroachment Agreement signed by the abutting property owner. The property owner, upon abandonment or termination of use, shall restore the Outdoor Dining Area to the same condition as existed prior to its use as an Outdoor Dining Area. Additionally, at such time the City may deem it necessary or desirable to modify the width of the street and/or the public sidewalk, the abutting property owner shall remove all Permanent Improvements from the public right-of-way or Major Street Setback Area at the property owner's expense. Existing permanent Outdoor Dining Areas, previously approved through a Street Encroachment Agreement, shall not require a new Street Encroachment Agreement.

L. Relocation by the City. Notwithstanding the foregoing regulations, the City, at its discretion, may relocate an approved Outdoor Dining Area on a temporary basis to an adjacent sidewalk within a public right-of-way, partially within the public right-of-way and partially upon private property within the Major Street Setback Area, and/or upon public property, including the publicly held rights-of-way to accommodate a public works project and mitigate the interruption of the permit operation. Application for relocation shall be made in writing to the Department of Public Works at least thirty (30) days prior to the proposed date of relocation and include a written statement signed by a majority of all of the owner(s) and the tenant(s) of adjacent occupied property(ies) approving the temporary relocation. The Department of Public Works shall submit the application to the Department of City Development, Fire Department, Police Department and the alderperson of the District in which the Applicant's business is located for review and recommendation, which must be returned to the Department of Public Works within seven (7) days of receipt. In such a case, the City, at the direction of the Director of Public Works, will determine the duration, the temporary location and provide the Permittee a site plan describing the temporary Outdoor Dining Area.

M. Alcohol Beverages in Outdoor Dining Area. Applicants who propose to sell/serve Alcohol Beverages in an Outdoor Dining Area must also complete an application for an "Outdoor Extension of Retail "Class B", Class "B", or "Class C" License as regulated by Section 10.075 of the Code of General Ordinances. Said application may be filed concurrently with the Outdoor Dining Area Permit. Approval of an Outdoor Dining Area Permit involving the sale/serving of Alcohol Beverages by the Committee on Licenses/Permits shall be conditioned upon approval of the Outdoor Extension License by the Common Council.

N. Appeal. Should the Committee on Licenses/Permits deny the application for an Outdoor Dining Area, the Applicant, by filing a written Notice of Appeal with the City Clerk/Treasurer within five (5) business days following, but not including, the day of denial, may appeal said denial to the Common Council. The appeal will be heard at a scheduled Common Council meeting as soon as practicable. However, to be heard at a given Common Council meeting, the Notice of Appeal must be filed a minimum of two (2) City business days prior to said meeting, not including the day of the scheduled meeting.

O. Suspension or Revocation of Permit and Removal of Outdoor Dining Area and Dining Appurtenances. The Committee on Licenses/Permits may suspend or revoke any permit issued hereunder and order the removal of an Outdoor Dining Area and Dining Accessory which is operated contrary to the terms of a permit issued under this Ordinance, upon providing permit holder with a reasonable time, not to exceed ten (10) days, in which to file a written request with the City Clerk/Treasurer to be heard in said matter, and show cause why the proposed action should not be taken. However, an Outdoor Dining Area and all Dining Appurtenances may be removed without prior notice or opportunity to be heard where it constitutes an immediate danger to the public health, safety or welfare, where it is not in conformance with representations made in the application, where the Certificate of Insurance was not provided or has expired, or where placed within any public right-of-way without a permit, contrary to the provisions of this Ordinance. In such cases, an opportunity for a post-removal hearing shall be provided following the foregoing provisions for an appeal.

P. Enforcement. The enforcement of this Ordinance shall be under the jurisdiction of the Department of City Development and Kenosha Police Department, who shall have the power to inspect Outdoor Dining Areas to determine compliance with this Ordinance. The Department of City Development shall be primarily responsible for enforcement during regular City Hall working hours. The Kenosha Police Department shall be primarily responsible for enforcement of this Ordinance during all other hours. Violations that are enforced by the Police Department shall be communicated to the Department of City Development.

Compliance with this Ordinance shall be obtained through written orders to the applicant, issued by the Department of City Development. Except in emergency situations, a minimum of ten (10) days shall be provided for compliance. Orders which are not timely complied with shall be subject to a suspension or revocation of an Outdoor Dining Area Permit and/or a financial penalty, as specified in this Ordinance.

Q. Special Exceptions. With respect to the following items, the Department of City Development shall have the discretion to recommend approval of alternative standards to the Committee on Licenses/Permits. The exceptions shall not present any hazard or danger to the public safety, health or welfare, and shall also meet the standards listed under each item.

1. Pedestrian Paths. The Pedestrian Path, as referenced in Section J.1.a., may be reduced in width, provided the reduction meets the following standards:

- a. The Pedestrian Path shall not be reduced to less than three (3') feet in width.
- b. The location of the Outdoor Dining Area is not located adjacent to a major street.
- c. Pedestrian traffic is minimal in the location of the proposed Outdoor Dining Area.
- d. The Outdoor Dining Area is enclosed by a barrier, as specified in Section J.1.e., to separate the dining area from the required Pedestrian Path.

2. Sidewalk Width Requirement. The required sidewalk width, as referenced in Section J.2.a., may be reduced to less than ten (10') feet, provided the reduction meets the following standards:

- a. The sidewalk shall not be reduced to less than eight (8') feet in width.
- b. The location of the Outdoor Dining Area is not located adjacent to a major street.
- c. The strict application of the required sidewalk width would result in denial of the application.

3. Paving of Lawn Park Areas. Paving of the lawn park area may be permitted when it meets the following standards:

- a. The paving has been approved by the Committee on Public Works.
- b. The paved lawn park area is conditioned upon removal and restoration of the lawn park area to prior conditions upon discontinuance of the Outdoor Dining Area.

R. Other Codes. Permits issued hereunder are conditioned upon compliance with the Building, Health, Fire and Zoning Codes, and inspections, licenses, approvals and permits thereunder, which may be

applicable.

S. Penalty. Any person, party, firm or corporation who violates any provision of this Ordinance shall, upon conviction, forfeit not more than Five Hundred (\$500.00) Dollars, plus the cost of prosecution. Each day of violation shall be deemed a separate offense.

5.05 CONSTRUCTION OF SIDEWALKS AND DRIVEWAY APPROACHES

A. Specifications, Materials, Dimensions. (See §66.0907 Wisconsin Statutes.)

1. Materials and construction methods used shall be as per specifications on file at the office of the Director of Public Works. Provisions of this Chapter will be enforced by the Director of Public Works.

2. Variances in line and grade due to trees and other obstructions, shall be approved by the Board of Public Works.

B. Registration and Permit.

1. **Registration Required.** No person, party, firm or corporation shall construct, modify, destroy, remove or repair any sidewalk or driveway approach in a public right-of-way without first registering to do so from the Director of Public Works. Each project shall require its own permit.

There shall be a fee for registration annually thereafter. The Common Council will, from time to time, by Resolution, establish the Registration Fee. All fees shall be paid to Public Works and all registrations shall expire on the January 1st following the issuance thereof, unless renewed. Should any work be commenced prior to the issuance of a permit, the fee shall increase to five (5) times the amount of the fee established by the Common Council by Resolution.

An owner of property improved by a singlefamily home who resides therein or intends to reside therein in the future for a period of not less than one year may, in his/her own person, construct, modify, destroy, remove or repair a sidewalk or driveway approach in the public right-of-way abutting their property without such license but shall, nevertheless, be required to furnish an "owners' bond" as provided in 2. below and obtain a permit as provided in 4. and/or 5. below.

2. **Bonds Required. Performance Bond.** Every person, party, firm or corporation engaged in the business of constructing, modifying, destroying, removing or repairing sidewalks or driveway approaches, before the issuance of the above registration, shall give a surety bond to the City of Kenosha in the penal sum of Ten Thousand (\$10,000) Dollars, which bond shall guarantee that all work is performed in accordance with this and other Ordinances of the City of Kenosha and laws, rules and regulations of the State of Wisconsin and which will indemnify the City for any damage to or obstruction of its public right-of-way, including its sanitary and storm sewers and water mains.

Owner's Bond. Any person constructing, modifying, destroying, removing or repairing a sidewalk or driveway approach abutting their single family home shall furnish a surety bond similar to the above, except that the bond shall be only in the penal sum of Ten Thousand (\$10,000) Dollars. No bond is required when sidewalk work involves less than one hundred (100) square feet of area and when driveway approach work involves less than twenty (20) square feet of area.

Insurance. A condition of such registration shall be the furnishing of a Certificate of Insurance. The certificate of liability insurance must name the City as an additional insured and contain a provision that the Director of Public Works must be notified twenty (20) days in advance of the effective date of any termination or cancellation thereof. The following minimum insurance coverages must be in effect and continue in effect during the term of registration.

- 1) Commercial General Liability
 - a. Each Occurrence \$1,000,000.00
 - b. General Aggregate \$2,000,000.00
 - c. Combined Single Limit (each accident) with the following coverages \$2,000,000.00
 - i. Premises
 - ii. Contractual Liability

CODE OF GENERAL ORDINANCES, 2021 - KENOSHA, WISCONSIN

- iii. Products and Completed Operations
- iv. Death and Personal Injury

2) Automobile Liability (any auto)	
a. Bodily Injury (per person)	\$1,000,000.00
b. Bodily Injury (per accident)	\$2,000,000.00
c. Property Damage (per accident)	\$500,00.00
3) Worker's Compensation – Statutory Limits	
a. Each Accident	\$100,000.00
b. Disease, Each Employee	\$100,000.00
c. Disease, Policy Limit	\$500,000.00
4) Umbrella Liability Coverage must be at least as broad as the underlying Commercial General Liability, Automobile Liability, Liquor Liability, Fireworks Liability, Statutory Liability and Employers Liability coverages	
a. Each Occurrence	\$2,000,000.00
b. General Aggregate	\$2,000,000.00

3. Permit Required. Sidewalk. No person, party, firm or corporation may construct, modify, destroy, remove or repair a particular sidewalk within the City, even though registered to do so, without first receiving a Sidewalk Permit. A Sidewalk Permit shall be issued by the Director of Public Works to anyone having registered, bond and insurance as herein required for a new sidewalk, sidewalk repair or mudjacking, parkway walk, carriage walk and/or walk grade for building construction. The Common Council will, from time to time, by Resolution, establish the Permit Fees. Should any sidewalk work be commenced prior to the issuance of a permit, the fees shall increase to five (5) times the amount of the fee established by the Common Council by Resolution.

4. Permit Required. Driveway Approach. A permit to construct, modify, destroy or remove a driveway approach is also required pursuant to §5.085 of the Code of General Ordinances.

5. Revocation of License. The Director of Public Works, following notice and an opportunity to be heard, may suspend or revoke any registration or permit of any holder thereof who violates this or any other relevant City Ordinance or State law, rule, regulation or any order of the Director of Public Works.

C. Public Sidewalks Required.

1. Definition.

a. **"Building"** shall include any structure occupied or used for dwelling, industrial or commercial related purposes.

b. **"Rural Type Section"** shall mean a roadway with pavement and roadside ditch.

2. Every owner of property which is presently improved by a building shall construct public sidewalks at their own expense in the public right-of-way abutting said property. Such sidewalks shall meet the requirements of §5.05 A. above. The Common Council, in its discretion, may modify the sidewalk construction specifications contained in §5.05 A. on petition of the property owner in cases where the public safety and welfare does not require strict compliance therewith. Any petition for modification granted by the Council pursuant to this Section shall, in no way, prohibit corrective orders relative to the width, placement and construction specifications of said sidewalk where the public safety and welfare shall require it.

3. Every property owner who shall hereafter improve their property with a building shall construct public sidewalks in the public right-of-way abutting said property immediately after the completion of construction of such building. Such sidewalks shall meet the requirements of §5.05 A. above. A Certificate of Occupancy shall not be granted to the owner or proposed occupier of a building within the City, and for which a Certificate of Occupancy was applied, unless a sidewalk shall have been installed or unless an agreement guaranteeing performance as evidenced by a performance bond, irrevocable letter of credit or

CODE OF GENERAL ORDINANCES, 2021 - KENOSHA, WISCONSIN

escrow of money shall have been furnished to the City, and approved as to form by the City Attorney. Said guaranty agreement shall provide for the earliest feasible installation of a sidewalk with due consideration to seasonal weather conditions and to the general development of the area in, about and abutting the building for which a certificate of occupancy has been applied, as determined by the Director of Public Works or designee thereof.

4. In a rural type section every property owner who shall hereafter improve their property with a building shall be required to construct public sidewalks when the roadway is improved to an urban type section. In such event, the sidewalk shall be constructed at the time of installation of the new pavement, curb and gutter.

5. The Common Council may, in its discretion, at any time, order the construction of, repair of, or replacement of public sidewalks at the expense of the abutting property owner whether the property is improved by a building or not, when deemed necessary to serve the public safety or convenience subject to the following procedure:

a. The Common Council must approve the necessity for the proposed construction, repair or replacement of public sidewalks by Resolution after giving the abutting property owner and the public the opportunity to be heard, before the Public Works Committee.

b. Written notice of the proposed construction, repair or replacement of a public sidewalk has been sent by 1st Class United States mail to the last recorded address of the abutting property owner or has been served upon the person of the abutting property owner.

6. Special assessments may be utilized to recover the cost of sidewalk construction, repair or replacement subject to the following procedure:

a. Written notice of the proposed construction, repair or replacement of a public sidewalk has been sent by 1st Class United States mail to the last recorded address of the abutting property owner or has been served upon the person of the abutting property owner.

b. The abutting property owner has been permitted the opportunity to be heard before the Board of Public Works on the necessity for the proposed construction, repair or replacement. The abutting property owner shall be given the opportunity to appear, with or without counsel, examine all written reports, call witnesses and submit written reports. The findings of the Board of Public Works shall be reduced to writing and submitted to the Common Council for approval.

c. The Common Council must approve the necessity for the proposed construction, repair or replacement of public sidewalks by Resolution after giving the abutting property owner and the public the opportunity to be heard, and after reviewing the report of the Board of Public Works.

d. The Common Council must approve, by Resolution, the amount of special assessment to be imposed upon the benefited property after the final determination of charges has been made. Appeal from this final determination shall be pursuant to the procedures outlined in §66.0703(12), Wisconsin Statutes.

7. Sidewalks shall not be required:

a. Within the City of Kenosha Industrial Park.

b. Within Industrial Parks of over twenty (20) acres upon application for an exception to the Common Council and approval thereof, when and for so long as not deemed necessary.

c. Within the Planned Development Overlay-PDO-District, as defined in §3.22 of the City of Kenosha Zoning Ordinance, upon application for an exception to the Common Council and approval thereof.

d. In the public right-of-way of property owned by the City of Kenosha. Exceptions in Subsections b. and c. may be granted for all or part of the area sought to be excepted. Exceptions may be denied where a public sidewalk is deemed necessary to serve the public safety and convenience.

8. **Sidewalk Requirement-Deferral.** No property owner shall have the sidewalk requirement of this Ordinance deferred unless it is recommended by the Board of Public Works and approved by the Common Council, and then only pursuant to the following criteria:

a. On boundary streets with an adjoining town or village, where the City limits are so irregular as to make it impractical to require the property owner within the City to have sidewalks constructed until the property abutting and remaining in the town or village shall have sidewalks constructed thereon.

b. On property zoned "Business (B-2)" which abuts a major State trunk highway.

5.051 LAWN PARK AREAS

A. Definitions

1. Lawn Park shall mean the area between the public sidewalk and the curblines of the street. Where there is no sidewalk, Lawn Park shall mean the area between the property line and the curblines of the street.

2. Sidewalk shall mean the area within a street or highway right-of-way used or reserved for pedestrian traffic.

3. Improve shall mean:

a. Permissible Plantings.

(1) To plant with grass suitable for local growing conditions;

(2) To plant with trees subject to species and spacing recommended by the City Forester; and

(3) To plant with other plantings which are recommended by the City Forester.

b. Landscape Features. All items placed in the lawn park must be easily removable to facilitate the repair and installation of public utilities. Permissible landscape features include:

(1) Ground Cover. Decorative stone, small rock, bark or mulch meant to protect and promote approved plantings shall be allowed provided the materials are stable and maintained so as not to scatter on sidewalk or streets. The finish grade of such a treatment must be flush with the top of the curb and sidewalk.

(2) Temporary wire fencing, lattices, stakes and strings used to support plants are permissible if necessary to assist the establishment of approved plantings but must be removed from the lawn park once the plantings have been established.

(3) Decorative hitching posts or structures if consistent and customarily associated with the neighborhood.

(4) Plant boxes, tree surrounds, edging materials similar Landscape Features which are less than twelve (12") inches in height. Such feature must be a minimum of twelve (12") inches from the edge of all driveways and driveway approaches, a minimum of twelve (12") inches from all property lines, a minimum of twelve (12") inches from the edge of the sidewalk, eighteen (18") inches from the back of the curb to allow ingress and egress for occupants of legally parked vehicles along the curb and not restrict access to fire hydrants.

4. Maintain shall mean:

b. Free from debris.

c. Decorative stone, bark or mulch to be managed so as not to scatter on sidewalk or street provided that the treatment surface is uniform and reasonably walkable.

d. Grass, trees and plantings to be in a healthy condition and trimmed so as not to constitute a public or private nuisance. Under no circumstances may any plantings encroach over a sidewalk, curb or roadway shoulder.

e. Grass not to exceed eight (8") inches in height.

f. Area to be made as safe as its nature will reasonably permit.

g. Area to be kept in compliance with the Ordinances which regulate exterior maintenance of abutting premises.

h. Lawn park plantings must be lower than thirty-six (36") inches in height. In order to provide a clear view at driveways and intersections for all users of the traveled way, the lawn park area within each intersection described as follows shall be kept clear of any plantings over twenty-four (24") inches in height:

(1) At the intersection of two (2) streets abutting a corner lot, the lawn park area subject to the twenty-four (24") inch limitation shall be the lawn park within four (4') feet of the intersecting property line. Dimensions of the clearance area may be reduced based upon the recommendation of the Traffic Engineer.

(2) At the intersection of a street with a private road, driveway, or alley, the lawn park area subject to the twenty-four (24") inch limitation shall be the lawn park within four (4') feet of the private road, driveway or alley.

i. Landscape features shall not create tripping hazards, puncture or cutting potential or project to cause bodily or vehicular harm or damage. Sharp corners, edges or material must be rounded or beveled.

5. Permissible Plantings. The City Forester shall maintain a list of recommended grasses, trees and planting permissible for improving the lawn park which may be amended from time to time at the discretion of the City Forester. In assessing which grasses, trees and plantings are permissible the City Forester should consider suitability, species, spacing, vision clearance, maintenance and compatibility with the site

CODE OF GENERAL ORDINANCES, 2021 - KENOSHA, WISCONSIN

and neighborhood. Any plant species that are deemed invasive are regulated under Wis. Admin. Code CH NR 40, which are poisonous, noxious or which have exposed, rigid spines or thorns are prohibited.

B. Purpose. The purpose of this Ordinance is to encourage a natural and aesthetically pleasing environment and to protect public health, safety and welfare by enhancing pedestrian and vehicular traffic safety.

C. Required Improvements. It shall be the duty of every property owner to improve the lawn park area abutting their property in conformance with this Ordinance. Improvements shall be maintained so as not to interfere with the public's right of travel over the lawn park area.

D. Exception.

1. Notwithstanding paragraph D.2., adjacent to a sidewalk associated with residential properties, the property owner may create a carriage walk by extending a walkway that exists between the residence and the sidewalk, such extension to be across the lawn park to the curb. Such carriage walk must be collinear with the walkway and may not be wider than the width of the walkway at the point the walkway meets the sidewalk. The carriage walk permitted must be composed of: concrete, brick pavers, concrete pavers; or natural field stone pavers; stone less than three inches in diameter and bituminous asphalt are prohibited. The carriage walk must be maintained to have as continuous and smooth a surface as the material will allow.

Carriage walks must be sloped in a manner that allows for drainage over the curb.

All carriage walks are subject to inspection and may be removed by the City at any time with written notice and without compensation. Carriage walks damaged by public works projects will be repaired by the City.

2. The Committee on Public Works may grant an exception, upon the petition of the abutting property owner, to the required improvements so as to permit the paving or other treatment of a lawn park area. In considering an application from an abutting property owner for an exception the Committee on Public Works shall consider issues relating to lawn park maintenance and street access to premises. The application may be granted in full or in part and may be conditioned upon trees or other plantings being installed in accordance with a plan approved by the City Forester. Petitions for exceptions are to be granted only for a good cause.

E. Required Maintenance. It shall be the duty of every property owner to maintain the lawn park area abutting their property in conformance with this Ordinance. The City's obligation to maintain is limited to enforcement of this Ordinance upon having notice of a violation.

F. Responsibility. The property owner is responsible for the lawn park improvements and understands that permissible plantings and landscape features in the lawn park are made at their own risks, and they may be removed by the City without compensation. The owner or occupant seeking to place permissible plantings or landscape features in the lawn park is responsible for contacting Digger's Hotline to identify and mark any underground utilities prior to digging within the right-of-way. Property owners will be provided written notice by City of Public Works projects which will damage or disturb lawn park improvements. City will restore lawn park areas to grass standard upon completion of the Public Works project. Restoration of any other lawn park improvements, except for those described in Section D.1. shall be subject to the discretion and at the expense of the property owner.

G. Enforcement. The enforcement of this Ordinance shall be under the jurisdiction of the Department of Public Works. With respect to exterior maintenance, the Department having jurisdiction of any exterior maintenance Ordinance applicable to the abutting property shall also have jurisdiction with respect to lawn parks.

Compliance with this Ordinance shall be obtained through written Orders to the abutting property owner, issued by designated enforcing officers of each Department having jurisdiction hereof, which shall provide a reasonable time for compliance. Except in emergency situations a minimum period of ten (10) days shall be provided for compliance. Orders which are not timely complied with may be enforced by citation or by the City doing or having done any corrective work and charging the cost thereof to the abutting property as a special assessment. The penalties for non-compliance shall be noted in any Order issued.

Any property owner in receipt of an enforcement order may appeal said order to the Committee on Public Works in the office of the Department of Public Works.

5.06 CURBSIDE WASTE AND RECYCLING COLLECTION AND REMOVAL

A. Definitions.

Auto Fluids means gasoline, diesel fuel, motor oil, antifreeze, car wax, brake fluid and transmission fluid.

Automated Cart means the Curbside Waste Automated Cart or the Curbside Recycling Automated Cart.

Biological Waste means **Infectious Waste**, Pathological Waste, Sharps, Pharmaceuticals, and Radioactive Waste.

Brush includes clean, woody, vegetative material no greater than six inches (6') in diameter. This term does not include stumps, roots or shrubs with intact root balls.

Bulky Solid Waste means Waste and Recyclable Material that cannot be contained entirely within an Automated Cart, including, but not limited to, antennae, beds, bicycles, box springs, cabinets, chairs, couches, doors, dressers, fencing, grills, gutters, lawn mowers, Major Appliances, mattresses, pools, rugs, screens, sinks, stereos, swing sets, television components, tables, toilets, large toy sets, vacuum cleaners and windows.

Clean Concrete means concrete, stone, brick and/or masonry products without hardware.

Cleaning Products means oven cleaners, drain cleaners, bleach, spot removers, detergents, window and floor cleaners and polishes, metal polishers.

Curbside Recycling Automated Cart is the cart provided and approved by the City for the purpose of automated curbside collection of recyclable materials. The Curbside Recycling Automated Cart is typically blue in color.

Curbside Waste Automated Cart is the cart provided and approved by the City for the purpose of automated curbside collection of waste materials. The Curbside Waste Automated Cart is typically tan in color.

Garden Chemicals means pesticides, weed killers, synthetic fertilizers, ant and rodent poisons, flea powder and fungicides.

Household Hazardous Waste means and includes Paint Products, Auto Fluids, Cleaning Products, Garden Chemicals, Miscellaneous Items.

Infectious Waste means waste contaminated with blood or other bodily fluids, or cultures or stocks of infectious agents from laboratory work.

Major Appliance(s) means an air conditioner, clothes dryer, clothes washer, furnace, boiler, dehumidifier, water heater, dishwasher, freezer, microwave oven, oven, refrigerator, or stove which is intended for disposal

Miscellaneous Items means photographic chemicals, lighter fluids, mercury batteries, moth balls, swimming pool chemicals and wood preservatives.

Paint Products means paints, specifically including paints that are lead,-based, latex or oil-based, paint thinners, paint or varnish strippers, solvents, varnishes, and lacquers.

Pathological Waste means human tissues, organs or fluids, body parts, and contaminated animal carcasses.

CODE OF GENERAL ORDINANCES, 2021 - KENOSHA, WISCONSIN

Person includes any individual natural person, partnership, corporation, non- stock corporation, limited liability company, limited liability partnership, association, or syndicate, local governmental unit, as defined in Section 66.0131(1)(a), Wisconsin Statutes, State agency or authority, or Federal agency.

Pharmaceuticals means expired, unused, and contaminated drugs and vaccines. Pharmaceuticals can include creams, ointments, over the counter medication, prescription medication, pet medication, sprays, liquids, and inhalers.

Radioactive Waste means products contaminated by radionuclides including radioactive diagnostic material or radiotherapeutic materials.

Recyclable Materials has the meaning provided in Section 5.119 of this Chapter.

Responsible Party means a Person who is an owner, operator, manager, occupant, or party in charge of a real property or a vehicle, which real property or vehicle is associated with application of this ordinance. The term "Responsible Party" includes the mortgagee or land contract vendor if the structure or premises is subject to a registration requirement under Chapter 28. The term "Responsible Party" does not include the City, holders of mortgages subordinate to other mortgages, or holders of any liens including mechanics' liens, or utility liens, special assessments, special charges, or tax delinquencies, against the real estate that includes the Structure or Premises, and does not include holders of liens of vehicles.

Sharps means medical and laboratory equipment generated by an infectious *waste* generator that may cause punctures or cuts. *Sharps* includes, but is not limited to, needles, syringes, lancets, and scalpel blades.

Special Collection Sticker means a sticker issued by the Department of Public Works for the disposal of Major Appliances.

SPI Code means the Society of the Plastics Industry Resin Identification Coding System, which is a set of numbers placed on plastic items to identify the resin type from which the items were made.

Waste means and includes garbage (all rejected matters that are subject to decomposition), ashes, rubbish and trash generated from typical residential activity, but not Yard Waste as defined in section 5.119 H., recyclable materials as defined in Section 5.119 H, Household Hazardous Waste, Biological Waste, and debris from construction or demolition.

Waste Collection System means City collection, transportation and disposal of Waste, Recyclable Materials, Major Appliances and Bulky Solid Waste.

Waste Oil includes the following: 2-cycle oil, crankcase oil, diesel fuel, fuel oil, gear lube, hydraulic oil, lubrication oil, motor oil and transmission oils only.

Waste Tire means a whole tire that is no longer suitable for its original purpose because of wear, damage or defect. Waste tire is designed for use on an automobile, motorcycle, or utility truck or service vehicle with an average weight per unit of forty (40) pounds or less.

Yard Waste means leaves, grass clippings, yard and garden debris.

B. Responsibility. Every Responsible Party is jointly and severally responsible for maintaining all property under their control in accordance with the requirements of this Section. For the avoidance of doubt, landlords and tenants are jointly responsible to comply.

C. Transportation of Waste Regulated. It is illegal for any Person, except an employee or agent of the City, to collect Waste or Recyclable Materials from the Lawn Park area or to transport Waste, Recyclable Materials, Major Appliances and/or Bulky Solid Waste that was owned by another Person on any street without obtaining a license therefor.

D. Dumping. It is illegal for any Person to dump or bury Waste, Recyclable Materials, Major Appliances, Bulky Solid Waste, Household Hazardous Waste, Yard Waste, Waste Tires, lead acid batteries, Auto Fluids, Clean Concrete, Brush, Waste Oil, Anti-Freeze and/or electronics, or hazardous or infectious

CODE OF GENERAL ORDINANCES, 2021 - KENOSHA, WISCONSIN

medical Waste on any street, alley, park, storm sewer, or public place, or on any private property without the private-property owner's consent.

E. Regulation for Collection. The Board of Public Works is authorized and directed to make regulations for the collection of Wastes, Recyclable Materials, Major Appliances, Bulky Solid Waste and which may prescribe:

1. Separation of Wastes, Recyclable Materials, Major Appliances for collection or disposal.
2. Time of collections.
3. Other requirements to be observed by patrons of the Waste Collection System.

F. Service Fees. Fees for patrons of the Waste Collection System may be determined from time to time by the Common Council, following review and recommendation by the Committee on Public Works and the Committee on Finance.

G. Waste and Recycling Automated Cart Collection

1. Standards of Collection. Residential waste and recycling will be collected by the Department from all applicable properties provided such waste and/or recycling is properly handled, prepared, contained, stored and located in conformance with this section and rules and regulations established and publicized by the Director of Public Works. The owner and/or occupant of any premises are responsible for the proper and sanitary storage, separation and preparation of waste and recycling accumulated at that premises until collected by the Department.

a. Schedule. The collection of Waste will be once weekly and the collection of Recycling will be once every two weeks from every residential building comprised of four or fewer living units in the City under schedules to be determined by the Department of Public Works.

b. Location. All Waste and Recyclable Material must be deposited for curbside collection on the day designated for collection in the area of the street right-of-way between the sidewalk and curb abutting the premises served. The Automated Carts must be made available to the City collection crews by being placed in an unobstructed location. Automated Carts must be placed a minimum of three feet (3') away from an obstruction and have a minimum of three feet (3') between them to allow for clearance of the automated arm. All Automated Carts must be placed so the wheels are to the sidewalk and/or the house.

(1) An exemption to this responsibility for placing Automated Carts at the curb because of incapacity of all members of the household may be granted by the Waste Superintendent.

c. Collection Container. All Waste must be placed within the Curbside Waste Automated Cart or Curbside Recycling Automated Cart per standards. All materials must fit into the designated container with the top closed. Subject to exceptions identified in other specific regulations herein, it is unlawful for any Person to deposit or permit the deposit of any materials outside of an Automated Cart.

(1) Automated Carts must not be filled so that the lid cannot be closed.

(2) Items within the Waste Automated cart must be contained within trash bags.

(3) Items within the Curbside Recycling Automated Cart, to the greatest extent practicable, must be clean and kept free of contaminants such as food, product residue, oil or grease, or other non-recyclable material. All Recyclable Material must be placed loosely within in the Automated Cart. Bagged items will not be accepted. All plastic bags are considered a non-recyclable material.

(4) Automated Carts must not be loaded with more than 335 pounds.

(5) Except for designations provided by the City, Automated Carts must not be marked, tagged, or otherwise individually identified as property of a person, such as but not limited to, spray paint markings, stickers, address numbers, carved letters or addresses.

(6) Automated Carts must not be destroyed, mangled, modified, altered in any form.

(7) If a residence requires additional Automated Carts, the property owner must apply to the City of Kenosha Department of Public Works on a form approved by that Department. The property owner requesting the additional Automated Cart will be charged a fee to obtain the second Automated Cart. The City limits every household to a maximum of two 95-gallon Waste Carts and a maximum of two 95-gallon Recycling Carts.

(8) An exemption to the requirement of waste or recycling outside the Automated Cart may be granted during specific times of the year by the Department of Public Works. Recyclable items outside of the Automated Cart will be limited to paperboard as defined in Section 5.119 During this period, the City will collect up to eight (8) 13-gallon bags of waste and/or recycling per residence placed outside of designated Automated Carts. At all other times, the above rules apply.

d. Collection Time. The Automated Carts must be made available to city collection crews by 6:00 a.m. on the scheduled collection date. The Automated Carts must not be placed prior to 6:30 p.m. the day

preceding the scheduled collection day. All automated carts must be removed from the curb by 8:00 a.m. on the day following the collection day.

e. Maintenance. All Automated Carts must be kept in a sanitary condition so as not to be offensive in smell or unsightly in appearance in a manner as to prevent creation of a nuisance to public health and safety

f. Cart Damage. All Damage to the Automated Carts must be reported immediately to the Department of Public Works. A City Representative will inspect the Automated Cart and make any necessary repairs or replacements. If the Automated Cart was determined to be damaged by acts of the owner or occupant the property owner will be responsible for purchasing a replacement Automated Cart. All Automated Carts are the property of the City and damaged Automated Carts will be returned to the City. A defective, damaged or lost Automated Cart not reported to the City may result in the issuance of a citation and the property owner will be responsible for the Automated Cart(s) replacement.

g. Cart Placement, Loss, and Replacement. Individual Automated Carts are assigned by the Director of Public Works to specific properties. Responsible Parties must maintain the individual Automated Carts at the specific property to which the Automated Cart was assigned. All lost Automated Carts must be promptly reported to the police.

H. Enforcement

1. Any Person who violates a provision of this Ordinance may be issued a citation by an authorized officer, employee or representative. The issuance of a citation does not preclude the City from proceeding under any other Ordinance or law relating to the same or any other matter. Proceeding under any other Ordinance or law relating to the same or any other matter does not preclude the issuance of a citation under this paragraph.

I. License.

1. License Required. Each Person using a privately-owned vehicle used for the transportation and collection of Waste, or Recyclable Materials within the City, where a fee for such service is charged therefor, must be licensed by the City prior to performing said service. The granting, issuance, and maintenance of the license are conditioned upon the licensee performing the services in accordance with City Ordinances and the regulations for such service as are or may be established by the Board of Public Works (Committee on Public Works). The fee for the license is Forty-five Dollars (\$45.00) for the first vehicle operated by the licensee and Thirty-five Dollars (\$35.00) for each additional vehicle. Licenses are issued by the City Clerk/Treasurer upon the advance payment in lawful United States currency of the amount therefor. All licenses expire on June 30th of each year. Licensees are responsible for maintaining any containers for Waste that the licensee has furnished to patrons, in good working order, in a sanitary condition, and in a manner that prevents leaks, or loss of Waste. Licensees are responsible for cleaning such Waste containers as often as is necessary in order to maintain them in a clean and sanitary condition, and the duty to clean said containers cannot be delegated to users of said containers.

2. Prohibition. It is unlawful for any Person to operate without the required license or to perform licensed services or any other activity contrary to this Ordinance or to the regulations for such service established by the Board of Public Works (Committee on Public Works).

J. Bulky Solid Waste, Recyclable Material and Major Appliance Collection and Removal

1. Special Pickup. Bulky Solid Waste from residential buildings of four (4) or less units will be collected upon the party desiring the pickup prearranging with the Public Works Department for a Special Pickup.

2. Number and Charge. There will be a limit of four (4) Special Pickups per year without charge. If there are requests for more than four (4) Pickups, there will be a pickup charge per each additional request, which will be determined from time to time by the Board of Public Works (Committee on Public Works).

3. Major Appliances. Effective March 1, 2004, Major Appliances must have a Special Collection Sticker attached prior to scheduling a Special Pickup. The fee for the sticker will be determined from time to time by the Board of Public Works (Committee on Public Works).

4. Designated Collection Area. Bulky Solid Waste and Recyclable Material must be deposited for collection in the area of the street right-of-way between the sidewalk and the curb abutting the premises served. It is unlawful for any Person to deposit or permit the deposit of Bulky Solid Waste for collection

which is not eligible for regular residential Waste pickup in other than the designated collection area, without having prearranged for Special Pickup at least than twenty-four (24) hours in advance of the scheduled Special Pickup.

K. Recyclable Materials. From the time of placement of Recyclable Materials at the collection point for collection by the City or its authorized agent(s), Recyclable Materials become the property of City, or its authorized agent(s). It is a violation of this Ordinance for any Person not authorized by the City to do so, to collect or pick up or cause to be collected or picked up any Recyclable Materials. Each and every such collection in violation hereof from any one Recyclable Material container constitutes a separate and distinct offense punishable as hereinafter provided.

L. Prohibited Collection Materia

1. Household Hazardous Wastes must not be deposited with Waste for curbside pickup. Household Hazardous Waste must be deposited only at the Kenosha Household Hazardous Waste Facility in accordance with the regulations applicable thereto.

2. Biological Waste *must not* be deposited into the general solid *waste* stream. Biological Waste *must* be disposed of at facilities located within the Kenosha area that accept Biological Waste. Pharmaceuticals must be disposed of in its original package or bottle and put in a sealed bag. All Pharmaceuticals must be disposed of at facilities identified by Kenosha County as permanent locations for residents to dispose of unused, unwanted and expired medication.

M. Placing Items out for Collection

1. Items must be placed at the curb for collection between 6:30 p.m. preceding the day of scheduled for collection and 6:00 a.m. of the day scheduled for collection. Placing items out for collection prior to 6:30 p.m. the day preceding the scheduled collection day may be deemed improperly placed; notwithstanding paragraph 16.20 A. 2, may be deemed a violation of Section 16.17; and/or may result in a citation under Chapters 5 or 16 of the Code of General Ordinances.

2. All Automated Carts and any Waste not collected must be removed from the curb by 8:00 a.m. on the day ensuing the day of collection.

N. Penalty. The penalty for a violation of this Ordinance upon conviction, is a forfeiture of not less than Fifty Dollars (\$50.00), nor more than Five Hundred Dollars (\$500.00) per violation, plus the costs of prosecution.

5.07 REMOVAL OF TREES IN HIGHWAY

A. Order Removing. The Board of Public Works may order the removal of any tree or limb of a tree which is unsafe, or a nuisance, or a hazard to the public and which stands or lies fallen between the lot line and the curb in front of any lot or parcel of land abutting on a street or avenue.

B. Notice. A copy of such order shall be served upon the owner of each lot or parcel of land in front of which any tree or tree limb is to be removed by personally delivering the same to the owner, his agent, or lessee.

C. Default of the Owner. Whenever any such owner shall neglect for a period of twenty days after such service to remove the tree or tree limb, the City, through its Board of Public Works, may cause such tree or tree limb to be removed at the expense of the owner. All work for such removal shall be let by contract to the lowest responsible bidder unless otherwise provided by council pursuant to Subsection (l) of §62.15, Wisconsin Statutes.

D. Minor Expense. Whenever the cost of removing any tree or tree limb shall not exceed the sum of ten dollars, the Board of Public Works, may immediately remove the tree or tree limb without notice or letting the work by contract, and charge the cost thereof to the owner of such lot or parcel of land, in the manner provided in this Section.

E. Expense. The Board of Public Works shall keep an accurate account of the expenses in removing trees or tree limbs in front of each lot or parcel of land, whether the work be done by contract or otherwise,

and report the same to the Director of Finance who shall annually prepare a statement of the expense so incurred in front of each lot or parcel of land, and the amount therein charged to each lot or parcel of land shall be by the Director of Finance entered in the tax roll as a special tax against said lot or parcel of land, and the same shall be collected in all respects like other taxes upon real estate.

5.08 PARKING FACILITIES

A. Definitions.

1. Parking Facility(ies) shall mean an off-street parking area, including lots from which motor vehicles are sold, but not including salvage yards or areas used to store towed motor vehicles, in any zoning district, which is utilized or constructed for the purpose of storing or parking five (5) or more motor vehicles, whether or not compensation for such services is charged, except for Parking Facilities owned or operated by a municipality and Parking Facilities owned or operated by industrial or manufacturing establishments and utilized for employee parking or for storing owned or leased vehicles.

2. Parking shall mean the keeping of motor vehicles for not more than one (1) day.

3. Storing shall mean the keeping of motor vehicles for more than one (1) day.

4. Motor Vehicles shall include mobile home, moped, motor bicycle, motor bus, motorcycle, motor-driven cycle, motor home, motor truck and motor vehicles, as defined in Chapter 340, Wisconsin Statutes. The term shall also include trailers.

5. Altered shall include enlarged, expanded, redesigned and reconstructed.

6. Director of Public Works shall include the designees thereof.

7. Parking Space shall be a designated place reserved for the placement of a stored or parked motor vehicle, exclusive of driveways, ramps, columns, office and work areas.

B. License for Parking Facility.

1. License Required.

a. No person, party, firm or corporation shall operate a parking facility within the City without first obtaining a license to do so from the Director of Public Works.

b. A Parking Facility License shall be required to be obtained from the operator of existing unlicensed parking facilities prior to the parking facility being altered, improved or modified, or where the property or business which uses the parking facility will have a change in occupancy, as defined in Section 8.04 of the City of Kenosha Zoning Ordinance.

2. License Fee. The license fee therefor shall be payable upon application. The fee, except for a processing fee, shall be refunded if the license is not issued. The Common Council will, from time to time, by Resolution, establish the Permit Fee. Should any parking facility work be commenced prior to the issuance of a permit, the fee shall increase to five (5) times the amount of the fee established by the Common Council by Resolution.

3. License Term. Licenses shall be in force and effect until suspended or revoked or until the Parking Facilities are altered and a new license here under issued or denied.

4. Exception. Parking Facilities licensed prior to the effective date of this Ordinance need not be relicensed hereunder unless they are altered.

5. Criteria for License Issuance. The Director of Public Works shall not grant a license hereunder unless:

a. The Parking Facility shall be located in conformance with the City Zoning Ordinance, as determined by a written report from the City Zoning Administrator.

b. The Parking Facility shall be constructed and maintained in conformance with all relevant State and City laws, rules and regulations.

c. Required Driveway Approach Permits are applied for and obtained and relevant work done in accordance therewith.

d. The Design Criteria for Parking Facilities herein specified is complied with.

e. The Parking Facility must be lighted at night in such a manner so as to make it as safe as the nature of the premises will reasonably permit for vehicular and pedestrian traffic.

6. Alteration of Parking Facilities. No Parking Facility shall be altered after the effective day of this Ordinance, without the operator thereof first obtaining a License hereunder, even though the Parking

Facility would have been exempt here from had there been no alteration thereof.

7. License Application. The license application shall include the following:

a. A plan of the Parking Facility drawn to a scale of one (1") inch being equal to twenty (20') feet on a single sheet of paper, which drawing shall indicate property lines, existing structures, proposed structures, the number arrangement and size of the parking spaces, location of existing and proposed driveway approaches, width of abutting public right-of-ways, proposed routing of entering and exiting vehicular traffic, dimensions and construction of area separating Parking Facility from abutting public right-of-way, the signing and color of pavement markings, specifications for proposed surface, proposed lighting, including pole location, height, and manufacturer and wattages of the luminaries, distance to intersecting streets and alleys, location, elevation and size of available storm sewers, elevations of Parking Facility indicated at twenty-five (25) foot intervals or one (1) foot contours, elevation of top of curb if no storm sewers are available, if the street is unimproved, the location and elevation of abutting drainage ditches and the proposed street centerline elevation, and the location of all buildings downspouts.

b. A proposed surface water drainage, containment and disposal plan, drawn to a scale of one (1") inch being equal to twenty (20') feet, which shall indicate the proposed finished elevations of the Parking Facility, the elevation of the proposed gutters and/or swales and the direction of surface water flow. The plan shall also indicate the elevations, locations and sizes of inlets, catch basins and storm sewers to be constructed in conjunction with the Parking Facility.

c. Name and address of owner and of party who will operate the Parking Facility and their legal status such as corporation, partnership, individual, etc.

d. Address of Parking Facility.

e. If any area of land was previously utilized as a Parking Facility, the date said use first occurred and whether or not and for what length of time, if any, said use has ever been interrupted, shall be stated.

8. Modifications of Plan. As an alternative to license denial, the Director of Public Works may propose modifications to any plans submitted, and if such modifications are accepted in writing by the applicant, the application shall be deemed so amended.

9. Suspension or Revocation. The Director of Public Works may suspend or revoke, following notice and hearing, any license which is issued hereunder where the terms of the license are not complied with, including the operation of a Parking Facility contrary to approved plans therefor, or the operation of any altered, previously licensed Parking Facility when no application has been filed and new license issued hereunder.

10. Appeal.

a. License Denial. A license applicant may appeal a license denial to the City Committee on Public Works within ten (10) days following receipt of written notice thereof. The notice of appeal shall be filed, in writing, with the Director of Public Works, and shall identify the issues.

b. License Suspension or Revocation. A license holder may appeal the suspension or revocation of their license to the City Committee on Public Works within ten (10) days following receipt of written notice thereof. The notice of appeal shall be filed in writing, with the Director of Public Works, and shall identify the issues.

c. Determination of Appeals. The City Committee on Public Works shall hear appeals at their next regular meeting following the filing of a notice of appeal, providing said notice is filed two (2) full working days in advance of such next regular meeting thereof. A final written decision containing findings and conclusions, unless agreed by appellant to the contrary, shall be issued by the City Committee of Public Works within thirty (30) days of the last date of the hearing thereon.

11. Commencement of Construction or Reconstruction. The proposed construction or reconstruction of a Parking Facility must commence within six (6) months of the granting and issuance of said license. A six (6) month extension of said time may be procured for good cause if an application therefor is applied for before the expiration of the six (6) month period of time heretofore specified.

C. Design Criteria for Parking Facilities. The following shall be the Design Criteria for Parking Facilities, including multilevel parking lots:

1. Conformance with requirements of the City Zoning Ordinance, City General Ordinances and State laws, rules and regulations. Where applicable, Conditional Use Permits must be obtained and screening in conformance with the Zoning Ordinance must be provided.

CODE OF GENERAL ORDINANCES, 2021 - KENOSHA, WISCONSIN

2. Parking spaces must be reserved for the physically handicapped and disabled in accordance with State and City laws, rules and regulations and appropriately marked as such.

3. The standard dimensions for a parking space shall be nine (9') feet in width and eighteen (18') feet in length. Dimensions for other space widths are given in **Tables 1** and **2** where appropriate. The space width(s) used is subject to the approval of the City Traffic Engineer. A maximum of twenty-five (25%) percent of the parking spaces required may be marked for small vehicles, provided that these spaces are designed in accordance with **Table 2**, are conveniently located, and are clearly identified and properly controlled for use only by small vehicles. "Small vehicle" is defined to mean any automobile or truck sixteen (16') feet or less in length. The location and control of small vehicle parking spaces is subject to the approval of the City Traffic Engineer.

4. The design of all parking facilities shall conform to the minimum dimensions specified in **Tables 1** and **2**. For any given parking angle between twenty (20°) degrees not specifically listed in the Tables, use a table angle nearest the given angle. When two (2) rows of stalls use the same drive aisle for access requiring two-way traffic because of space layout, the drive aisle shall be either eighteen (18') feet in width or that which is called for in **Tables 1** and **2**, whichever is greater.

5. The location of parking spaces, direction of traffic and notation of two- way and one-way traffic shall be clearly marked in a highly visible manner.

6. Driveway entrances and exits shall be in accordance with the requirements of **Tables 1** and **2** and shall be at the location specified in a Driveway Approach Permit.

7. Surface water must not be permitted to drain upon any abutting property without the written consent of such landowner.

8. The surface of the Parking Facility shall be permanently improved with Portland Cement concrete, paving brick or with bituminous concrete pavement and must be maintained in a dust free condition to the extent possible.

9. No parking space shall extend closer than two (2') feet to any abutting property line or to the line of any right-of-way and a substantial and permanent bumper shall be placed so as to separate motor vehicles from abutting property lines or from the line of any street right-of-way so as to prevent the motor vehicle from crossing said lines.

10. No parking stall shall be located so as to require a vehicle, upon exiting, to back into any public right-of-way, except alleys may be used for ingress and egress into the Parking Facility provided the setbacks as established in **Tables 1** and **2** are complied with.

11. The internal traffic circulation of a Parking Facility shall be such that vehicles are not required to back up, except for exiting a parking stall.

12. Illumination of a Parking Facility shall be such as not to cast light rays directly onto any public right-of-way or adjacent property. Illumination shall be in accordance with specifications on file in the Office of the City Department of Public Works.

13. Conformance with specifications therefor on file in the Office of the City Department of Public Works.

14. Any other design requirement imposed by the Director of Public Works.

(See Appendix - Table 1)

(See Appendix - Table 2)

D. Penalty. Any person, party, firm or corporation who shall violate this Ordinance, shall upon conviction thereof, forfeit not more than Five Hundred (\$500) Dollars, plus the cost of prosecution. If such forfeiture and costs are not promptly paid, the violator shall be imprisoned in the County Jail for a period not to exceed ten (10) days. Each day of violation shall be a separate offense.

5.082 CITY OWNED PARKING STRUCTURE

Definitions.

1. **Actively Parking** means any or all of the following:

operating a motor vehicle within the Parking Structure to a Parking Space or from a Parking Space in exiting the building;

positioning a motor vehicle in a Parking Space;

halting a motor vehicle in a Parking Space;

returning to a halted motor vehicle in a Parking Space to actively place an item into the halted vehicle or remove an item from the halted vehicle.

2. **Charging Station** is a mechanism installed by the City on the premises of the Parking Structure that supplies electric energy to plug-in electric motor vehicles.

3. **Closing Hours** means the hours between 2:00 A.M. and 5:00 A.M. each day, which is the time frame during which the Parking Structure is closed.

4. **Parking Space** means a space marked by the City in the Parking Structure for the halting of a motor vehicle. It is *prima facie* evidence that a space is a Parking Space if there exist parallel lines painted on the pavement designating the space, which space is of a dimension to accommodate the placement of halted motor vehicle within the space.

5. **Parking Structure** means a City-owned structure of more than one level, the principal use of which is to park motor vehicles.

6. **Responsible Person** means the person who operated the motor vehicle while it is in the Parking Structure and/or the owner of the motor vehicle.

7. **Smoking** means "Smoking" as defined in Wis. Stat. §101.123(1)(h) and/or "Electronic Smoking" as defined in Section 4.05 of the Code of General Ordinances.

B. Regulations.

1. When not engaged in Actively Parking, it is illegal for a person while in the Parking Structure to:

- a. engage in Smoking, except in areas specifically designated for Smoking;
- b. obstruct entrances, hallways, lanes, Parking Spaces, aisles, stairways, or elevators;
- c. interfere with any other person lawfully using the premises of the Parking Structure;

d. remain upon the premises of the Parking Structure for more than ten minutes when not otherwise Actively Parking;

e. enter or remain within or on a motor vehicle within the Parking Structure or ramp except for the period of time reasonably necessary to Actively Park such vehicle or to prepare such vehicle to leave the Parking Structure; and

f. enter into a Parking Structure after Closing Hours or enter into a portion of a Parking Structure that has been ordered closed by order of the Mayor, Public Works Director, or Director of the Transit Department.

2. It is illegal for a Responsible Person to allow a motor vehicle that is owned by the Responsible Person or was operated by the Responsible Person as it entered into the Parking Structure, to remain in the Parking Structure during Closed Hours. In addition to any other penalty identified herein, motor vehicles

CODE OF GENERAL ORDINANCES, 2021 - KENOSHA, WISCONSIN

remaining in the Parking Structure during Closed Hours may be towed by direction of the Mayor, Public Works Director, Director of the Transit Department, or Chief of the Police Department, or any of their designees, at the Responsible Person's expense.

C. Exceptions.

1. The regulations in B. 1. b., d., e., and f do not apply to employees or contractors of the City, or to protective service personnel in the performance of their duties.

2. The regulations in B. 1. d and e. do not apply to a passenger in a motor vehicle that is being operated by another while being Actively Parked within the Parking Structure.

3. The regulations in B. 1. d. and e. do not apply to Responsible Persons who remain within fifteen feet of their motor vehicle while the motor vehicle is actively charging at Charging Stations.

4. The regulation in B. 2. does not apply to motor vehicles in a Parking Structure that are on the premises of the Parking Structure pursuant to a permit for parking in the Parking Structure issued by a lessee of the City for Parking Spaces, which lessee is a hotel, provided the form of the permit is approved by the Director of the Transit Department, or his or her designee, and such permit is displayed on the dashboard of the motor vehicle.

D. Enforcement.

The Police Department is authorized to enforce all provisions of this Section and may issue citations for violations thereof.

E. Penalty.

Anyone violating any of the provisions of this Section, upon conviction thereof, upon a first violation within a 365-day period, is subject to a forfeiture of fifty dollars (\$50), plus the payment of the costs of prosecution, assessments, and surcharges, and in default of the timely payment thereof, may either be committed to the County Jail for a period not to exceed one (1) day, or the Court may suspend the defendant's motor vehicle operating privileges until the forfeiture, assessments, surcharges, and costs are paid, except that the suspension period may not exceed five (5) years.

Second and subsequent violations within a 365-day period are subject to a forfeiture of up to one-hundred dollars (\$100) plus the payment of the costs of prosecution, assessments, and surcharges, and in default of the timely payment thereof, may either be committed to the County Jail for a period not to exceed two (2) days, or the Court may suspend the defendant's motor vehicle operating privileges until the forfeiture, assessments, surcharges, and costs are paid, except that the suspension period may not exceed five (5) years.

5.085 DRIVEWAY APPROACHES

A. Definitions. For purposes of this Ordinance, the following words shall have the meaning thereafter provided:

1. **Class I Driveway Approach** shall mean a driveway approach which serves a Type "A" site or a single parcel of property located in a residential zoning district or business zoning district which is used for residential purposes.

2. **Class II Driveway Approach** shall mean a driveway approach which serves property located in a business zoning district or in an institutional park zoning district which is not used primarily for residential purposes.

3. **Class III Driveway Approach** shall mean a driveway approach which serves business or manufacturing property and which is primarily used by buses or semi-trailertrucks.

4. **Curb Cut** shall mean that section of concrete curb removed to permit the entrance and exit of vehicles from adjacent property and shall be measured at the entrance width plus the allowable flare.

5. **Director of Public Works** shall include designees thereof.

6. **Driveway** shall mean every way or area in private ownership used for vehicular travel back of the street right-of-way line.

7. **Driveway Approach** shall mean an area within a public right-of-way which is improved for motor

vehicle traffic and which connects a private road or driveway to a portion of a public right-of-way which is improved for motor vehicle traffic.

8. Entrance shall mean the point at which a driveway abuts the driveway approach.

9. Flare shall mean the portion of a driveway approach which is wider at the street curb line than at the entrance.

10. Intersection Turning Area shall mean the part of the street intersection included between the radius line used to connect the curb lines and the intersection of the curb lines, if extended.

11. Type "A" Site shall mean property in a residential zoning district containing a single residential structure of one or two dwelling units having fewer than five (5) off-street parking spaces.

12. Type "B" Site shall mean all property, whether one or more contiguous lots or parts of lots, which does not meet the definition of a Type "A" site.

B. Driveway Approach Permits.

1. Permit Requirement. No person, party, firm or corporation may construct, modify, destroy or remove a driveway approach within the City or cut into any curb within the City for the purpose of constructing a driveway approach, without first having obtained a Driveway Approach Permit from the Director of Public Works. A Driveway Approach Permit shall only authorize such work to be done at a specified location, during a specified period of time, and it shall not be a substitute for a license under §5.05 B., Ordinances, where one is required.

2. Permit Application. Applications for a Driveway Approach Permit shall be made on City authorized forms and filed with the Director of Public Works. Application forms shall be signed by the owner(s) of the land to be served by a driveway approach. Where land was sold under a land contract, only the buyer need sign the application form. Attached to an application form for a Class II or Class III Driveway Approach Permit shall be a plan on a single sheet of paper drawn to a scale of one (1") inch equals twenty (20') feet, indicating the proposed driveway approach, including the flare thereof, any existing driveway approach, the property lines of applicant's property and any building or structures thereon, any private designated traffic lanes on applicant's property with markings showing the direction of traffic flow, the width of the abutting public right-of-way and the width of any portion thereof reserved for motor vehicle traffic, the location of any intersecting streets or alleys within three hundred (300') feet of the driveway approach, the location of driveway approaches on abutting property, the surface treatment of the driveway approach, the rate of slope or grade of the driveway approach, the location of utility poles, fire hydrants, trees and other structures or obstructions within the portion of the public right-of-way abutting applicant's property which is not used or to be used for motor vehicle traffic.

3. Permit Fee. The Common Council will, from time to time, by Resolution, establish the Permit Fees for new Driveway Approaches and the repair or widening of existing Driveway Approaches, which shall be payable upon application and nonrefundable. Should any such work be commenced prior to the issuance of a permit, the fee shall increase to five (5) times the amount of the fee established by the Common Council by Resolution.

4. Permit Duration. Permits granted shall be in effect for six (6) months, during which time all proposed work must be completed. A three (3) month extension of said time may be procured for good cause if an application for an extension therefor is applied for before the original permit expires.

C. Permit Conditions and Criteria.

1. Discontinued driveway approaches must be removed and curb and gutter installed in place thereof.

2. A driveway approach serving a Type "B" site will be approved only if the driveway approach can be used as such without motor vehicles being necessitated to be backed into any arterial or collector street.

3. The Director of Public Works must be notified of the completion of the construction of any driveway approach within two (2) working days thereafter, for the purpose of the inspection thereof.

4. The number of driveway approaches shall be limited as follows:

a. A maximum of two (2) driveway approaches shall be permitted to a Type "A" site.

b. A maximum of two (2) driveway approaches from each of any one or two abutting streets shall

CODE OF GENERAL ORDINANCES, 2021 - KENOSHA, WISCONSIN

be permitted to a Type "B" site or to a Type "A" site where more than two (2) separate buildings containing dwelling units are located on the same site.

c. However, the Director of Public Works may, when there is no adverse effect upon traffic on abutting streets as determined by the Traffic Engineer, authorize additional driveway approaches, subject to the following guidelines:

(1) One (1) additional driveway approach along a continuous site frontage in excess of six hundred (600) feet or two (2) additional driveway approaches along a continuous site frontage in excess of twelve hundred (1,200) feet.

(2) One (1) additional driveway approach from each of not more than two (2) abutting streets where continuous frontage is less than six hundred (600) feet; provided that such additional approach(es) be used exclusively as a service drive for the purpose of loading or unloading materials or merchandise, and which drive is physically separate from other off street vehicle facilities and not available to customers thereof through the use of a six (6") inch high raised rolled asphalt, or poured in place concrete, curb or a guardrail erected eighteen (18) inches in height to the center measured from the paved parking surface.

(3) One (1) or two (2) driveway approaches per additional abutting streets.

5. The location of driveway approaches shall be subject to the following:

a. No entrance shall be closer than fifteen (15') feet to the right-of-way line of an intersecting street, provided that no part of any driveway approach shall encroach on any intersection turning area (curb radius). Alleys shall be exempt from this provision and may be defined as "approaches," provided that the total maximum dimensions shall not exceed those permitted for other "approaches" in the same class. Where the alley is not included, the entrance must be a minimum of five (5') feet from the nearest boundary line of the alley.

b. No entrance shall be closer than one-half (1/2) foot to an abutting property line. This requirement shall not apply when adjacent property owners sign a joint application for a Driveway Approach Permit to service abutting driveways.

c. Any two (2) entrances to the same lot shall be at least ten (10') feet apart.

d. All driveway approaches shall be so located as to provide adequate sight distance in both directions along the street for safe access to the street without interfering with vehicular and pedestrian traffic on the street or sidewalk.

6. The maximum and minimum specifications for driveway approaches shall be as follows:

a. Class I

Maximum permitted width of entrance	20 feet
Minimum permitted width of entrance	8 feet
Maximum permitted curb cut	25 feet
Minimum permitted curb cut	13 feet
Maximum flare	2.5 feet

b. Class II*

Maximum permitted width of entrance	30 feet
Minimum permitted width of entrance	18 feet
OR two entrances of 10 feet minimum under one-way operation	
Maximum permitted curb cut	40 feet
Minimum permitted curb cut	28 feet
Maximum flare	5 feet

*Minimum permitted entrance width is nine (9) feet when serving twelve (12) or fewer vehicle parking spaces at a multiple-dwelling unit facility.

c. Class III

Maximum permitted width of entrance	4 feet
Minimum permitted width of entrance	35 feet
Maximum permitted curb cut	70 feet
Minimum permitted curb cut	65 feet
Maximum flare	15 feet

d. Exceptions. Upon application for an Exception to the maximum and minimum specifications for driveway approaches defined herein, the Committee on Public Works may, with a survey to the centerline of the adjacent street provided by the Applicant, and, after investigation and public hearing, grant an Exception for the maximum and minimum specifications for driveway approaches provided that the Committee determines that (a) such Exception will not present a hazard or danger to public safety, (b) the entirety of the driveway will be on the Applicant's property, and (c) the granting of the extension is consistent with the purpose of the established specifications.

7. An application for a Class III driveway approach may be approved only if plans are submitted by the applicant showing that the requested driveway approach will be used nearly exclusively by semitrailers and/or buses serving the site, and that other driveway approaches intended for the exclusive use by smaller vehicles will not be used by semi-trailers and/or buses, and, further, that the use of the property is for business, industrial or manufacturing purposes.

8. The following special design features may be permitted at high-volume driveway approaches, if approved by the Director of Engineering Services/City Engineer and City Traffic Engineer:

a. One (1) or more driveway approaches may be replaced by a street-type entrance. The cost of additional drainage structures necessitated by such entrance(s) shall be borne by the permittee.

b. One (1) or more driveways to a major traffic generator may be replaced with special geometrically designed approaches and entrances where such generated traffic volumes and turning movements are in such numbers as to significantly reduce the capacity of the adjacent street and/or pose a hazard to through traffic on the adjacent street. These special geometrically designed approaches and entrances include, but are not limited to, speed change lanes, median crossovers, traffic islands and special driveway approach design treatments. The owner of the traffic generator shall be financially responsible for the cost of the special geometrically designed approaches, street lighting, traffic signals, and conduit necessitated at such approaches and entrances.

c. Right-of-way areas adjacent to driveway approaches shall be left undisturbed. A drawing accompanying the application shall show exactly how encroachment on such adjacent areas is to be prevented. If encroachment develops a need for additional protection, it shall be provided promptly by the permittee.

9. Permittee shall have the obligation to maintain any driveway approach constructed and shall assume all liability arising out of the construction and maintenance thereof and shall indemnify and hold harmless the City and its officers, employees and agents from and against any liability, loss, damages, claims, judgments, court costs or attorneys fees which they may sustain or incur should any person or party suffer or sustain death, personal injury, or property damage therefrom.

10. The construction of the driveway approach shall not interfere with or obstruct any public right-of-way without a Street Encroachment Permit first having been obtained to do so as provided by Ordinance.

11. All work done relative to any driveway approach shall be at permittee's expense.

12. The permit may specify drainage requirements.

13. Driveway approaches must be paved, prior to use or occupancy of the property served, in accordance with specifications therefor on file in the Office of the City Department of Public Works. If the abutting portion of the right-of-way reserved for use by motor vehicles is not permanently improved, then this requirement is deferred until such time as such permanent improvements are completed.

14. The permit may be conditioned upon the Permittee, at his expense, placing conduit for traffic control or street lights under the driveway approach, pursuant to the specifications on file in the Office of the City Department of Public Works.

15. Driveway approaches shall be a sufficient distance from a controlled intersection so that the use thereof will not interfere with vehicular traffic within or approaching such intersection. Driveway approaches for parking facilities where large volumes of traffic enter or exit at one time shall be a minimum distance of one hundred twenty-five (125) feet from the crosswalk of any intersection.

16. No driveway approach shall be located at the terminal end of a marked or unmarked crosswalk.

D. Denial of Application. An application for a Driveway Approach Permit may be denied where street access is prohibited to and from a parcel of land through a Subdivision Plat, Certified Survey Map, Condominium Plat, Development Agreement, Master Plan or deed restriction.

E. Special Assessments Where Street Access Denied. Where all access to and from a parcel of land is denied or prohibited to a certain street ("street" includes highway), the property abutting such street shall not be specially assessed for street grading and paving due to lack of benefit. Notwithstanding the above, sidewalk special assessments are permitted. Sanitary sewer, storm sewer and water services are not governed by this Section.

The Director of Public Works shall keep a record of the amount of the special assessment which would have been levied against the abutting property had the property benefitted from the street by having access thereto.

Should the property later obtain street access, a Driveway Approach Permit shall be conditioned upon payment of the amount of the unlevied special assessment.

F. Penalties. Any person, party, firm or corporation, who violates any provision of this Ordinance shall be subject to, upon conviction, a maximum forfeiture of Five Hundred (\$500) Dollars, plus the costs of prosecution. If such forfeiture and costs are not promptly paid, the violator shall be imprisoned in the County Jail for a period not to exceed ten (10) days. Each day of violation shall be deemed a separate offense.

5.09 INSTALLATION OF MODERN (ORNAMENTAL) LIGHTING

A. Definitions.

1. **Modern Lighting.** As designated by the City of Kenosha, is synonymous with Ornamental Lighting, as designated by the Wisconsin Electric Power Company.
2. **Luminaires.** Are the light producing elements.
3. **Brackets.** Are the fixtures mounted on the poles for the suspension of the luminaires.
4. **Lighting District** is a thoroughfare or a group of thoroughfares to be lighted.

B. Categories. The modern lighting requirements of the City of Kenosha are to be divided into four categories:

1. Thoroughfares through F Commercial areas.
2. Main thoroughfares for the rapid movement of traffic.
3. Newly widened or repaved main thoroughfares
4. Lighting districts as established under §5.09 F. shall include other streets, areas, sections, or districts of the City of Kenosha not included in 1., 2. and 3. above.

C. Thoroughfares running through F Commercial areas are designated as the following lighting districts:

1. Lighting District Number One (1):

5th Avenue from 55th Street to 59th Street.

6th Avenue from 55th to 59th Street.

6th Avenue "A" from 59th Street to 59th Place.

7th Avenue from 55th Street to 59th Place.
8th Avenue from 52nd Street to 59th Street.
56th Street from 5th Avenue to 8th Avenue.
55th Street from 5th Avenue to 8th Avenue.
57th Street from 5th Avenue to 8th Avenue.
58th Street from 5th Avenue to 8th Avenue.
59th Street from 5th Avenue to 8th Avenue.

2. Lighting District Number Two (2):

22nd Avenue from 60th Street to Roosevelt Road.
63rd Street from between 23rd and 24th Avenues to 20th Avenue.
Roosevelt Road from between 23rd and 24th Avenues to 20th Avenue.

3. Lighting District Number Three (3):

55th Street from 8th Avenue to Sheridan Road.
56th Street from 8th Avenue to Sheridan Road.
57th Street from 8th Avenue to Sheridan Road.
58th Street from 8th Avenue to Sheridan Road.

4. Lighting District Number Four (4):

22nd Avenue from 57th Street to 60th Street.
23rd Avenue from Roosevelt Road to 63rd Street.

5. Lighting District Number Five (5):

6th Avenue from 7th Avenue intersection to 55th Street.
51st Place.
51st Street from 6th Avenue to 8th Avenue.
52nd Street from 6th Avenue to Sheridan Road.

6. The lighting of F Commercial thoroughfares is not to be construed as that of main thoroughfares whose main purpose is the rapid movement of traffic. For thoroughfares running through F Commercial areas the City will from the general fund install two lights at each street intersection. Special assessments shall be levied and collected against abutting property in the amount such property is benefited thereby for all remaining lighting requirements, and for lights at intersections over and above those of mercury luminaires. Such special assessments to be made, levied, and collected pursuant to §66.0703 of the Wisconsin Statutes.

7. At the direction of Common Council, districts will be lighted by priority according to its use by the general public. Those districts attracting the greatest number of people per year being given priority.

D. Main Thoroughfares designed to rapidly move traffic through the City of Kenosha are as follows:

1. 7th Avenue from 52nd Street north to Sheridan Road intersection. Sheridan Road from north City limits to south City limits.
22nd Avenue from 57th Street north to City Limits.
22nd Avenue from Roosevelt Road south to City Limits.
30th Avenue from Washington Road south to City Limits.
39th Avenue from 52nd Street south to 80th Street.
50th Street from 30th Avenue east to 6th Avenue.
52nd Street from Highway 31 east to 6th Avenue.
60th Street from 20th Avenue east to Sheridan Road.
60th Street from City Limits east to Library Park and around to 59th Street at 6th, 7th, and 8th Avenues and south to 60th Street.
63rd Street from 30th Avenue east to between 22nd and 23rd Avenues.
63rd Street from 20th Avenue to Sheridan Road.
75th Street from City Limits east to Lake Michigan.
80th Street from 30th Avenue to Sheridan Road.
Roosevelt Road from 39th Avenue east to between 23rd and 24th Avenues.
Washington Road from City Limits east to 7th Avenue.
Wilson Road.
Lincoln Road.

2. These main thoroughfares are to be lighted at the direction of Common Council by priority, according to the resultant figures of dividing the number of miles into the total of accidents and crimes. Exceptions to this are listed under ¶¶E.4. and E.5.

3. All costs incurred under ¶D. are to be borne by the City of Kenosha in the general public interest.

E. Main Thoroughfares which are newly widened or repaved or scheduled to be newly widened or repaved will be lighted in the following manner:

1. Main thoroughfares are designated under ¶D.1.

2. At the direction of Common Council, the Wisconsin Electric Power Company will be contacted and requested to reset their wooden poles at 100 foot intervals on newly widened or repaved main thoroughfares as listed in ¶D.1. If the Power Company cannot comply, the main thoroughfares in question will be lighted under Paragraph D.

3. Luminaries and brackets will be purchased at the direction of Common Council and installed on these poles contingent upon agreements made with the Wisconsin Electric Power Company.

4. These newly widened or repaved main thoroughfares are to be considered at the direction of Common Council over all other main thoroughfares.

5. Main thoroughfares listed under ¶D.1. that are scheduled to be widened or repaved at a future date will not be lighted until the widening or repaving has been accomplished.

6. All costs under Paragraph E. are to be borne by the City of Kenosha in the general public interest.

F. Other Lighting Districts As Established By Council. The Common Council may establish by resolution other streets areas, sections, or districts in the City of Kenosha as lighting districts. Such resolutions shall define the districts and shall provide for the method of installation.

5.10 MINIMUM WAGE SCALE FOR CERTAIN PUBLIC WORKS CONTRACTS

A. Definitions. In this Ordinance:

1. **"Building or Work"** shall mean construction activity as distinguished from manufacturing, furnishing of materials, or servicing and maintenance work, but "building or work" shall include the delivery of mineral aggregate such as sand, gravel, asphaltic concrete or stone which is incorporated into the work under contract with the City by depositing the material substantially in place, directly or through spreaders, from the transporting vehicle.

2. **"Public Works Construction"** shall mean building or work involving the erection, construction, remodeling, repairing or demolition of buildings, parking lots, sidewalks, street lighting, traffic signals, sanitary sewers, water mains and appurtenances, storm sewers, and the grading and landscaping of public lands.

B. Application. This Ordinance shall only be applicable to public works construction contracts estimated to be over Twenty-Five Thousand Dollars (\$25,000.00).

C. Minimum Wage Scale. The Director of Public Works, or his/her designee, or the Manager of the Kenosha Water Utility, or his/her designee, prior to the bidding or letting of a contract for any public works construction, shall determine the rate of wage scale which shall be paid by the contractor to the employees upon the project. Except for known increases contained within the schedule, the prevailing wage rate shall

not change during the contract. The Director of Public Works, or his/her designee, or the Manager of the Kenosha Water Utility, or his/her designee, shall apply to the Wisconsin Department of Workforce Development with respect to public works construction where it has jurisdiction, to ascertain the prevailing wage rate, hours of labor and hourly basic pay rates in all trades and occupations required in the work contemplated. In other cases, the Director of Public Works, or his/her designee, or the Manager of the Kenosha Water Utility, or his/her designee, shall make said determinations. No laborer, worker or

mechanic employed directly upon the site of the project by the contractor or by a subcontractor, agent or other person, doing or contracting to do any part of the work, may be paid less than the prevailing wage rate in the same or most similar trade or occupation; nor may he or she be permitted to work a greater number of hours per day or per calendar week than the prevailing hours of labor determined under this subsection, unless he or she is paid for all hours in excess of the prevailing hours at a rate of at least 1-1/2 times his or her hourly basic rate of pay. An employee's classification shall not be changed to a classification of a lesser rate during the contract.

This subsection does not apply to wage rates and hours of employment of laborers, workers or mechanics engaged in the processing or manufacture of materials or products, or to the delivery thereof by or for commercial establishments which have a fixed place of business from which they regularly supply such processed or manufactured materials or products. This subsection does apply to laborers, workers or mechanics delivering mineral aggregate such as sand, gravel or stone which is incorporated into the work under the contract by depositing the material substantially in place, directly or through spreaders, from the transporting vehicle.

Questions regarding employee classification, rate of pay or rate of pay within a classification, shall be resolved by reference to the established practice that predominates in the industry and on which the trade or occupation rate/classification is based.

D. Records And Evidence Of Compliance. Each contractor, subcontractor or agent thereof participating in a project covered by this Ordinance shall keep full and accurate records clearly indicating the name and trade or occupation of every laborer, worker or mechanic employed thereby in connection with the project and an accurate record of the number of hours worked by each employee and the actual wages paid therefor.

Each agent or subcontractor shall furnish the contractor with evidence of compliance with this subsection.

Upon completion of the project and prior to final payment therefor, each contractor shall file with the Department of Public Works or the Kenosha Water Utility, whichever Department determined the wage scale in Subsection C. herein, an affidavit stating that contractor has complied fully with the provisions and requirements of this Ordinance, and that contractor has received evidence of compliance from each of contractor's agents and subcontractors. No final payment shall be made until such an affidavit is filed in proper form and order.

The Director of Public Works, or Manager of the Kenosha Water Utility, or City Attorney, or designee thereof, may demand and examine copies of any payrolls and other records and information relating to the wages paid laborers, workers or mechanics on work to which this Ordinance applies.

E. Bids, Classifications and Posting.

1. Reference to prevailing wage rates and hours of labor determined by the Wisconsin Department of Workforce Development shall be published in the notice issued for the purpose of securing bids for the project. Wherever any contract for any public works construction is entered into, the wage rates and hours determined shall be incorporated into and made a part of such contract.

2. After bids have been opened and made public, the contractor who has submitted the apparent low bid, by the end of the next regular work day of the City, shall submit in writing the classifications of all the employees of the contractor, subcontractors and agents, and the total number of hours estimated in each classification for the work. The classifications shall be reviewed by the Director of Public Works or General Manager of the Kenosha Water Utility, who may, within ten (10) days, object to any classification which is not reflective of that which would be required for the work. Failure to comply with this paragraph may result in rejection of the bid.

3. For the information of the employees working on the project, the wage rates and hours determined by the Department of Workforce Development, the Director of Public Works, or General Manager of the Kenosha Water Utility shall be kept posted by the employer in at least one conspicuous and easily accessible place at the site of the project.

F. Penalty. Whenever the Director of Public Works, General Manager of the Kenosha Water Utility,

or the Department of Workforce Development for the State of Wisconsin, has established a rate of wage scale to be paid to employees for public works construction by a contractor and it is found upon due proof that the contractor is not paying or has failed to pay the wage scale established, or is directly or indirectly, by a system of rebates or otherwise, violating this Ordinance, the contractor may be required to pay a forfeiture not to exceed Five Hundred (\$500.00) Dollars for each offense, plus the costs of prosecution. The failure to pay the required wage to an employee for any one (1) week or part thereof constitutes a separate offense.

5.11 SIDEWALKS AND ALLEYS TO BE KEPT CLEAN BY RESPONSIBLE PARTY

A. Definitions. The following definitions shall apply in the interpretation and enforcement of this Ordinance:

1. **"Alley"** means a public thoroughfare less than thirty (30) feet in width.

2. **"Sidewalk"** means that portion of a street between the curb lines, or the lateral lines of a roadway and the adjacent property lines intended for the use of pedestrians, whether paved or unpaved.

With respect to corner lots, the sidewalk shall include the crosswalk area and extend to the curb or street line, and include the curb.

3. **"Responsible Party"** as herein used means the owner, occupant or party in charge of the property abutting or fronting a sidewalk, whether they be a person, partnership, corporation, joint stock company or syndicate. In construing the provisions of this Section, only owners of vacant lots or vacant premises are deemed to be the proper person whose duty it shall be to comply with the provisions of this Section; where the real property consists of a single family residence or is solely used for business, the owner or occupant shall be deemed to be the proper person whose duty it shall be to comply with the provisions of this Section; and as to any other real property, the owner or any occupants, unless a person has been designated in writing by the owner to be the person in charge of the premises and is residing thereon, are deemed to be the responsible party whose duty it shall be to comply with the provisions of this Section.

4. **"Thoroughfare"** shall mean an open, unoccupied space permanently reserved for the purpose of access to abutting property.

B. Duty.

1. The responsible party shall remove and clear away or cause to remove or clear away all snow and ice from sidewalks within twenty-four (24) hours of the day following a snow fall; provided that when ice has so formed on any sidewalk that it cannot be removed, then the persons herein before referred to shall cause said ice from remaining and presenting a hazard to the users of the sidewalk by use of sand, abrasive material or any product designed to prevent ice from forming or to remain in its form and not to be injurious to the health and safety of the public.

2. The responsible party shall keep the sidewalk clean of any dirt or dust, when paved, and of any cinders, ashes, mud, oil and other similar substances when the sidewalks are clear of snow and ice.

3. The responsible party shall keep the sidewalk clear of water and ice accumulations, in the same manner provided in Subsection 1. above, when said accumulations of water or ice are caused by a runoff of water from any natural or man made source originating from the abutting or fronting property, including, but not limited to, water discharged from sump pumps.

4. The responsible party shall keep and maintain the alley abutting their property, to the centerline thereof, clean and free from all garbage, trash, junk, paper and debris at all times, and clean of any dirt or dust when paved, and of any cinders, ashes, mud, oil and other similar substances when the alley is clear of snow and ice.

C. Enforcement. It shall be the duty of the Department of Public Works, upon receiving a complaint from a party identifying themselves by name and address, to investigate an alleged violation of this Ordinance. Designees of the Director of Public Works may enforce this Ordinance through the issuance of citations.

D. Stipulation As To Guilt Or Plea Of No Contest. Any responsible party receiving a citation for failure to comply with this Ordinance, shall be permitted to stipulate his guilt to the offense charged upon payment of the penalty herein designated. The stipulation of guilt shall be made on a form approved by the City Attorney setting forth the date of offense, date citation issued, the name of the person issuing the citation, the location of the violation, and an admission of guilt or plea of no contest evidenced by the signature of the person arrested. Payment of the penalty herein designated must accompany the stipulation

of guilt or no contest, which may be mailed to or delivered to the Office of the City Clerk/Treasurer.

E. Penalty. The penalty for violation of this Ordinance shall be as follows:

1. Twenty (\$20) Dollars for the first violation within a given calendar year.
2. Forty (\$40) Dollars for the second and third violations within a given calendar year.
3. Sixty (\$60) Dollars for the fourth violation and every violation thereafter, within a given calendar year.
4. The above penalties shall double if not paid within seven (7) days of the date of the offense, not including the day of the offense.
5. The penalty provisions of §5.12 of this Chapter are not applicable, being superseded by this subsection.

F. Emergency Enforcement. In addition to the penalties herein prescribed, the Director of Public Works, or his designee, shall be authorized to do, or have done, such acts as are necessary to bring the abutting or fronting sidewalk and or alley in compliance with this Ordinance. Once each calendar year, the City Department of Public Works shall publish a legal notice in the official City newspaper advising responsible parties of their duties hereunder and of the penalties for noncompliance with this Ordinance and the remedial powers of the Department of Public Works. Prior to the Department of Public Works doing or authorizing any work to be done at the cost and expense of the responsible party, an attempt shall be made to notify the responsible party by written notice, served personally or by mail. Said Director, or designee, shall keep an itemized record of expenses incurred and submit said itemization to the responsible party for payment within thirty (30) days of the date of service thereof, not including the date of service. If such charge is not paid when due, the Director, or designee, is authorized to pay said bill, if the services were not performed by City employees. Said Director, or designee, is further directed to collect the unpaid portion of said invoice as a special charge against the abutting or fronting property. A Seventy (\$70.00) Dollar Administrative Fee for processing and administering the special assessment shall be added to the special assessment against the abutting or fronting property.

G. Saving Clause. Should any part or provision of this Ordinance be declared unconstitutional and unenforceable, the remaining constitutional provisions shall be deemed separable and of full force and effect.

5.115 SUMP PUMPS

A. Definitions.

1. "**Director**" shall mean the Director or acting Director of the Department of Public Works, or his/her designee.
2. "**Public Nuisance**" shall mean a water discharge from any sump pump within the City which accumulates or freezes on any public right-of-way or which is discharged into a City sanitary sewer or which otherwise endangers the public health, safety or welfare. A public nuisance shall be deemed to exist where the condition complained of has temporarily ceased to exist but where the condition is likely to occur in the future.

B. Specifications. Foundation drains shall be connected to sump pits as specified in the State Plumbing Code. Sump pumps and the installation of sump pumps shall be in compliance with the State Plumbing Code.

C. Discharge. All construction in lands platted or subdivided after January 1, 1999, shall provide for the connection of all sump pump discharge lines directly to the nearest available storm sewer line; or, where a storm sewer is not available, onto the surface of the ground at least ten (10') feet from the building foundation. Where a storm sewer is not available, the discharge shall be directed to flow to the rear lot line or toward the street and shall not be directed so as to flow onto adjacent property, so as to flow over or

accumulate upon a public sidewalk or as to create or maintain a public nuisance. Whenever a sump pump discharge is determined by the Director to have flown over or accumulated upon a public sidewalk, the Director may order the owner of the property which is the source of the said discharge to bury under the public sidewalk a nonporous conduit for said discharging waters which will be cut into the curb, where present, so as to enable the discharging water to flow directly into the gutter of the street.

CODE OF GENERAL ORDINANCES, 2021 - KENOSHA, WISCONSIN

D. Notice to Property Owner. Where the Director has determined that the discharge from a sump pump is unlawful or has created a public nuisance, the Director shall notify the property owner thereof and order compliance with this Ordinance or the abatement of said public nuisance within thirty (30) days following the date of the notice.

E. Appeal. The property owner may appeal the order of the Director to the Public Works Committee by serving a notice of appeal upon the Director within the thirty (30) day period referred to in Subsection D. The Public Works Committee shall hold a hearing within thirty (30) days following the receipt of the request therefor and it may uphold, reverse or modify the order of the Director. If the Public Works Committee upholds the Director in full or in part, the property owner shall be ordered to take corrective action within thirty (30) days following the date of the decision of the Public Works Committee.

F. Waiver. The property owner, by not requesting a timely hearing following the receipt of a thirty (30) day notice and order, shall waive any right he may have or claim to said hearing.

G. Corrective Action By Director. In the event of an illegal sump pump discharge, whether or not the discharge has caused a public nuisance, the Director may take corrective action where the property owner fails to do so in a timely manner, and the Director shall bill the property owner for the full cost of corrective acts and demand payment within thirty (30) days. Where timely payment has not been made, the Director shall tax said cost against the property, which was the site of the offense herein relevant, as a special assessment.

In the event that a public nuisance has resulted from a lawful sump pump discharge and a redirection of the discharge is required to abate the public nuisance, the Engineering Division shall develop a plan and cost estimate for nuisance abatement, and forward said plan and estimate to the Committee on Public Works and owner(s) of relevant property. The Committee, following notice and opportunity to be heard, may authorize the City to participate in the cost of nuisance abatement, where sufficient funds have been appropriated therefor. Under such circumstances, the property owner shall be liable for fifty (50%) percent of the cost of abatement or One Thousand (\$1,000) Dollars, whichever is less.

5.116 SIDEWALK INSPECTION AND REPLACEMENT POLICY AND PROCEDURE

A. Purpose. The purpose of this Ordinance is to create a policy and procedure for sidewalk inspection and replacement so as to provide for sidewalk replacement before a sidewalk deteriorates to the point that it could endanger the public safety.

B. Policy. It is the declared policy of the City of Kenosha that sidewalks shall be kept in repair by and at the expense of abutting property owners.

C. Procedure. The City Engineer shall have the authority of the Board of Public Works as provided for in §66.0907, Wisconsin Statutes, and he/she shall designate one (1) or more subordinates as Sidewalk Inspectors who shall have the duty of inspecting the sidewalks within the City and ordering and arranging for the replacement or repair of sidewalks. The costs of sidewalk replacement or repair, where performed by or through the City, shall be billed to the property owner and if not paid within thirty (30) days, collected as a special assessment pursuant to Section 2.10.

D. Definitions Of Words Used Herein.

1. **"Crack"** shall mean a fissure within a sidewalk square.
2. **"Joint"** shall mean a cleavage created for expansion purposes which separates two or more sidewalk squares.
3. **"Pitch"** shall mean the constructed slope of a sidewalk to the street (normally one quarter inch per foot).
4. **"Sidewalk(s)"** shall mean a public sidewalk within the street right-of-way.
5. **"Sidewalk Square"** shall mean that portion of a sidewalk bordered by joints and the sidewalk edge.
6. **"Spalling"** shall mean a chipped or splintered condition of a sidewalk square.

E. Notices And Special Assessments. Section 66.615, Wisconsin Statutes, incorporated herein by reference, shall govern notices and special assessments.

F. Examples Of Conditions That Could Develop Into Hazards. Sidewalk Inspectors shall consider the following examples of conditions which, if not addressed, could develop into a hazard, in determining whether to order a sidewalk square replaced or repaired:

1. There is a difference in height greater than one (1") inch in the elevation of adjacent sidewalk squares, except in business and commercial districts where there is a difference in height greater than one-half (1/2") inch.
2. The pitch of the sidewalk is greater than one (1") inch per foot.
3. There is a crack greater than one-half (1/2") inch in width, except in business and commercial districts where there is a crack greater than one-quarter (1/4") inch.
4. There is a difference in height greater than one-half (1/2") inch in the elevation of adjacent sections of a crack.
5. There is a depression greater than one-half (1/2") inch within a sidewalk square.
6. There is spalling which has resulted in a depression greater than one-quarter (1/4") inch.
7. There has been a temporary sidewalk repair.

G. Temporary Sidewalk Repair. No sidewalk square shall be ordered or arranged to be repaired by way of crack fillers, wedges, surface treatments or the like by a Sidewalk Inspector, except as a temporary measure pending replacement. Sidewalk squares which, upon inspection, are noted to have been temporarily repaired shall be ordered or arranged to be replaced. However, where the only defect is a difference in elevation due to settlement, it shall be permissible to remedy said condition without replacing the sidewalk square.

H. Documentation of Inspection. Sidewalk Inspectors, upon finding a sidewalk in need of replacement or repair, shall document the date of sidewalk inspection and condition of the sidewalk, and notify the property owner in writing of the condition of the sidewalk and corrective action required.

5.117 CONTROL OF NOXIOUS WEEDS

A. Definitions.

1. **"Noxious Weeds"** shall mean Canada Thistle, leafy spurge, field bindweed (Creeping Jenny), Ambrosia trifida (commonly called Giant Ragweed), Arubuoisia artemesiifia (commonly called Common Ragweed), and such other weeds as are defined in "Weeds of the North Central States, North Central Regional Research Publication No. 281, Bulletin 772" published by the University of Illinois at Urbana-Champaign, College of Agriculture, Agricultural Experiment Station, and grass which is equal to or exceeds eight (8") inches in height.

2. **"Destroy"** shall mean the complete killing of weeds or the killing of weed plants above the surface of the ground by the use of chemicals, cutting, tillage, cropping system, pasturing livestock, or any or all of these in effective combination, at such time and in such manner as will effectually prevent such plants from maturing to the bloom or flower stage.

B. Requirement. Every person shall destroy all noxious weeds on all lands which he shall own, occupy or control, including lawn park areas defined and governed by §5.051 of the Code of General Ordinances. Every person shall destroy all noxious weeds on all lands which he shall own, occupy or control. Within the city this shall include the parkway, which is the abutting property owner's responsibility, per §5.051. The person having immediate charge of any public lands shall destroy all noxious weeds on such lands.

C. Notice. On or before May 15 of each year, a Class 2 Notice, under Ch. 985, Wisconsin Statutes, shall be published in the official city newspaper, that every person is required by law to destroy all noxious weeds on lands within the city which the person owns, occupies or controls.

D. Weed Commissioner. The Director of the Department of City Inspections, in accordance with Section 66.0517, Wisconsin Statutes, shall, upon appointment by the Mayor, be the "Weed Commissioner", and shall designate subordinates to assist him or her in the performance of the duties of said position, who shall be Deputy Weed Commissioners. Weed Commissioners and Deputy Weed Commissioners shall perform their duties without special and separate compensation.

E. Destruction of Noxious Weeds by Weed Commissioner. The Weed Commissioner shall destroy noxious weeds which equal or exceed eight (8") inches in height by cutting, and shall recover the cost through special assessments levied against the property upon which noxious weeds were cut. A One-hundred (\$100.00) Dollar Administrative Fee for processing and administering the special assessment shall be added to the special assessment against the benefited property.

5.118 CITY OWNED CEMETERIES

A. Definitions. Improvement shall mean any building, structure or utility. The term shall not include fencing and landscaping, the placement or construction of burial vaults, mausoleums, the placement or replacement of any headstone, or any appurtenances customarily found in cemeteries.

B. Construction, Installation And Placement Of Improvements. No improvement shall be constructed, installed or placed upon a City owned cemetery until the plans and site therefor have been reviewed by the Committee on Public Works, City Plan Commission and the Landmarks Commission.

C. Prohibited Uses. No City owned cemetery or portion thereof shall be used for any purpose which is not related to the operation and maintenance of a cemetery. Utility easements shall not be granted in, under or across any City owned cemetery which are not related to the operation of said cemetery.

5.119 RECYCLING

A. Purpose. The purpose of this Ordinance is to promote recycling, composting, and resource recovery through the administration of an effective recycling program, as provided for in Section 159.11, Wisconsin Statutes, and Chapter NR 544, Wisconsin Administrative Code.

B. Statutory Authority. This Ordinance is adopted as authorized under Section 159.09(3)(b), Wisconsin Statutes, and the Code of General Ordinances for the City of Kenosha, Wisconsin.

C. Abrogation and Greater Restrictions. It is not intended by this Ordinance to repeal, abrogate, annul, impair or interfere with any existing rules, regulations, ordinances or permits previously adopted or issued pursuant to law. However, whenever this Ordinance imposes greater restrictions, the provisions of this Ordinance apply.

D. Interpretation. In their interpretation and application, the provisions of this Ordinance are the minimum requirements and are not a limitation or repeal of any other power granted by the Wisconsin Statutes. Where any terms or requirements of this Ordinance may be inconsistent or conflicting, the more restrictive requirements or interpretation apply. Where a provision of this Ordinance is required by Wisconsin Statutes, or by a standard in Chapter NR 544, Wisconsin Administrative Code, and where the Ordinance provision is unclear, the provision must be interpreted in light of the Wisconsin Statutes and the Chapter NR 544 standards in effect on the date of the adoption of this Ordinance, or in effect on the date of the most recent text amendment to this Ordinance.

E. Severability. Should any portion of this Ordinance be declared unconstitutional or invalid by a court of competent jurisdiction, the remainder of this Ordinance is not affected.

F. Applicability. The requirements of this Ordinance apply to all Persons within the City of Kenosha, Wisconsin.

G. Administration. The provisions of this Ordinance will be administered by the Department of Public Works.

H. Definitions. For the purposes of this Ordinance:

Bi-metal Container means a container for carbonated or malt beverages that is made primarily of a combination of steel and aluminum.

Brush includes clean, woody, vegetative material no greater than six inches (6') in diameter. This term does not include stumps, roots or shrubs with intact root balls.

Clean Concrete means concrete, stone, brick and/or masonry products without hardware.

Container Board means corrugated paperboard used in the manufacture of shipping containers and related products.

CODE OF GENERAL ORDINANCES, 2021 - KENOSHA, WISCONSIN

Electronics means equipment containing electronic components such as resistors, transistors, capacitors, diodes, inductors, and transformers, and circuit boards containing the same. The term “electronics” includes cell phones, DVD players, gaming devices, laptops, monitors, scanners, computers, fax machines, hard drives, computer mouse, printers, copiers, televisions, flash drives, keyboards, modems, radios, VCR player, DVR players, but specifically excludes Major Appliances as defined herein.

HDPE means high density polyethylene, labeled by the SPI Code #2.

Hours of Collection. Collection will not commence before 7 a.m. and will be completed by 10:00 p.m. on any single collection day.

LDPE means low density polyethylene, labeled by the SPI Code #4.

Magazines means magazines and other materials printed on similar paper.

Major Appliance means an air conditioner, clothes dryer, clothes washer, furnace, boiler, dehumidifier, water heater, dishwasher, freezer, microwave oven, oven, refrigerator or stove, which is intended for disposal.

Mixed Waste Paper includes junk mail, school papers, telephone books, untreated office paper, stationary, paper bags, construction paper, file folders, un laminated folders, un glossed greeting cards, paperback books, hardcover books (if hard cover is removed), fliers, catalogs, typing paper, printer paper, brown and white paper bags, envelopes, bills and invoices.

Multiple-Family Dwelling means a property containing five (5) or more residential units, including those which are occupied seasonally.

Newspaper means a newspaper and other materials printed on newsprint.

Nonresidential Facilities and Properties means commercial, retail, industrial, institutional and governmental facilities and properties. This term does not include Multiple Family Dwellings.

Office Paper means high grade printing and writing papers from offices in Nonresidential Facilities and Properties. Printed white ledger and computer printout are examples of Office Paper generally accepted as high grade. This term does not include industrial process waste.

Other Resins or Multiple Resins means plastic resins labeled by the SPI Code #7.

Paperboard includes dry unlined boxboard items that do not have a wax coating, and that are not food or beverage contaminated.

Person includes any individual natural person, partnership, corporation, non- stock corporation, limited liability company, limited liability partnership, association, or syndicate, local governmental unit, as defined in Section 66.0131(1)(a), Wisconsin Statutes, State agency or authority or Federal agency.

PETE means polyethylene terephthalate, labeled by the SPI Code #1.

Plastic Container means an individual, separate, rigid plastic bottle, can, jar or carton, except for a blister pack, that is originally used to contain a product that is the subject of a retail sale.

PP means polypropylene, labeled by the SPI Code #5.

PS means polystyrene, labeled by the SPI Code #6.

PVC means polyvinyl chloride, labeled by the SPI Code #3.

Recyclable Materials includes lead acid batteries; Major Appliances; waste oil; Yard Waste; aluminum containers; corrugated paper or other Container Board; brown, green, clear and mixed glass containers; Magazines; Newspaper; Office Paper; Rigid Plastic Containers, including those made of PETE, HDPE, PVC, LDPE, PP, PS, and Other Resins or Multiple Resins; steel containers; waste tires that have been removed from the rim or wheel; and Bimetal Containers.

CODE OF GENERAL ORDINANCES, 2021 - KENOSHA, WISCONSIN

Recycling Drop Off Facility the City has a recycling facility drop located at the City's Waste Division at 1001 50th Street. The Recycling Drop off facility will be open during scheduled times.

Recycling Facility means any facility or property designated and operated by the City as a site to be used by authorized Persons for the deposit and disposal of recyclable materials.

Responsible Party means a Person who is an owner, operator, manager, occupant, or party in charge of a real property, which is associated with application of this ordinance. The term "Responsible Party" includes the mortgagee or land contract vendor if the structure or premises is subject to a registration requirement under Chapter 28. The term "Responsible Party" does not include the City, holders of mortgages subordinate to other mortgages, or holders of any liens including mechanics' liens, or utility liens, special assessments, special charges, or tax delinquencies, against the real estate that includes the Structure or Premises.

Rigid Plastic Containers means stiff or inflexible containers made of PETE, HDPE, PVC, LDPE, PP, PS, and Other Resins or Multiple Resins.

Solid Waste has the meaning specified in Section 144.01(15), Wisconsin Statutes.

Solid Waste Facility has the meaning specified in Section 144.43(5), Wisconsin Statutes.

Solid Waste Treatment means any method, technique or process which is designed to change the physical, chemical or biological character or composition of Solid Waste.

Treatment includes incineration.

Special Collection Sticker means a sticker issued by the Department of Public Works for the disposal of Major Appliances.

Street Division Yard is located at 6415 35th Avenue and will be open during scheduled times.

Waste Drop Off Facility is the City's waste drop off facility at the Waste Division located at 1001 50th Street. The Waste Drop Off Facility will be open during scheduled times.

Waste Oil includes the following: 2-cycle oil, crankcase oil, diesel fuel, fuel oil, gear lube, hydraulic oil, lubrication oil, motor oil and transmission oils only.

Waste Tire means a whole tire that is no longer suitable for its original purpose because of wear, damage or defect. Waste tire is designed for use on an automobile, motorcycle, or utility truck or service vehicle with an average weight per unit of forty (40) pounds or less.

Yard Waste means leaves, grass clippings, yard and garden debris.

I. Separation of Recyclable Materials. Occupants of single family and two (2) to four (4) family residential units, Multiple Family Dwellings and Nonresidential Facilities and Properties must separate the following materials from Post-Consumer Waste:

- Aluminum Containers;
- Bimetal Containers;
- Clean Concrete;
- Corrugated Paper or other Container Board;
- Electronics;
- Lead Acid Batteries;
- Magazines;
- Major Appliances; Brown, green and clear glass containers;
- Mixed Waste Paper
- Newspaper;
- Office Paper;
- Paperboard;
- Rigid Plastic Containers;
- Rims separated from Waste Tires;

CODE OF GENERAL ORDINANCES, 2021 - KENOSHA, WISCONSIN

Steel Containers;
Waste Oil and Anti-Freeze;
Waste Tires separated from rims; and
Yard Waste.

J. Separation Requirements Exempted. The separation requirements of Subsection I. do not apply to the following:

1. Occupants of single family and two (2) to four (4) family residential units, Multiple Family Dwellings, and Nonresidential Facilities and Properties that send their Postconsumer Waste to a processing facility licensed by the Wisconsin Department of Natural Resources (DNR) that recovers the materials specified in Subsection I. from Solid Waste in as pure a form as is technically feasible.

2. Solid Waste which is burned as a supplemental fuel at a facility if less than thirty percent (30%) of the heat input to the facility is derived from the Solid Waste burned as supplemental fuel.

3. A Recyclable Material specified in Subsection I. for which a variance has been granted by the Department of Natural Resources under Section 159.11(2m), Wisconsin Statutes, or Section NR 544.14, Wisconsin Administrative Code.

K. Care of Separated Recyclable Materials. To the greatest extent practicable, the Recyclable Materials separated in accordance with Subsection I. must be clean and kept free of contaminants such as food or product residue, oil or grease, or other non-Recyclable Materials, including, but not limited to, Household Hazardous Waste, Biological Waste and agricultural chemical containers. All Recyclable Material must be placed loosely within in the Curbside Recycling Automated Cart. Bagged items will not be accepted. All plastic bags are considered a non-recyclable material. Recyclable Materials must not be deposited at curbside for collection prior to 6:30 p.m. the day preceding the scheduled collection day, but must be set on the curbside no later than 6:00 a.m. on the scheduled collection day. Recyclable Materials must be recycled in accordance with Section 5.06.

L. Management of Lead Acid Batteries, Major Appliances, Waste Oil and Anti-Freeze, Yard Waste, Brush, and Clean Concrete. Occupants of single family and two (2) to four (4) family residential units must manage lead acid batteries, Major Appliances, waste oil, and Yard Waste as follows:

1. **Lead acid batteries** must be taken to an area retail business which sells batteries or to the Recycling Facility.

2. **Major Appliances** must be deposited for curbside collection in accordance with Section 5.06.

3. **Waste oil and Anti-Freeze** must be taken to the Recycling Facility or the Street Division Yard. All other oils must be disposed of in accordance with Household Hazardous Waste.

4. **Yard Waste** must be taken to the Yard Waste Drop off Facility. For six (6) weeks in the Spring and eight weeks in the Fall, Yard Waste will be collected curbside Under the following regulations:

a. **Standards for Curbside Collection.** Curbside Yard Waste collection will be collected six (6) weeks in the Spring and eight (8) weeks in the Fall.

b. **Biodegradable Bags.** All Yard Waste must be placed within a City of Kenosha approved biodegradable bags.

c. **Location.** Yard Waste must be deposited for collection in the area of the street right-of-way between the sidewalk and the curb abutting the premises served. It is unlawful for any Person to deposit or permit the deposit of Yard Waste for collection which is not eligible for regular residential Waste pickup in other than the designated collection area.

d. **Collection Time.** All Yard Waste biodegradable bags must be made available to city collection crews by 6:00 a.m. on the scheduled Waste collection date during specified curbside Yard Waste weeks. The Yard Waste biodegradable bags must not be placed into the Location prior to 6:30 p.m. the day preceding the scheduled collection day. If any tagged bags remain after the Yard Waste collection the Person and/or Property owner must remove the items from the curb by 8:00 a.m. on the day following the collection day.

5. **Brush** may be dropped off at the Yard Waste Drop off Facility or a curbside pickup may be scheduled by calling the Public Works Department.

a. **Standards of Curbside Collection.** Brush will be collected by the Department, from all applicable properties, provided that a prearranged Special Pickup was scheduled at least the day prior to the scheduled collection day or during normal working hours whichever is earlier. All brush must be less than six inches (6") in

CODE OF GENERAL ORDINANCES, 2021 - KENOSHA, WISCONSIN

diameter, less than foot (3') in length, and must be secured in a bundle bound with string or twine. There is a limit of forty (40) pounds per bundle.

b. Schedule. Only Brush that has a prearranged Special Pickup will be collected.

c. Location. Brush must be deposited for collection in the area of the street right-of-way between the sidewalk and the curb abutting the premises served. It is unlawful for any Person to deposit or permit the deposit of Brush for collection which is not eligible for regular residential Waste pickup in other than the designated collection area, without having prearranged for Special Pickup, or more than twenty-four (24) hours in advance of a scheduled curbside pickup.

d. Collection Time. All Brush must be made available to city collection crews by 6:00 a.m. on the scheduled collection date. The Brush must not be placed into the Location prior to 6:30 p.m. the day preceding the scheduled collection day. If any tagged items remain after the Brush collection, the Person and/or Property owner must remove the items from the curb by 8:00 a.m. on the day following the collection day.

6. Clean Concrete may be taken to the Street Division Yard.

M. Preparation and Collection of Recyclable Materials. Except as otherwise directed by the City of Kenosha Public Works Department, occupants of single family and two (2) to four (4) family residential units are the only entities from which the City will collect materials for recycling. Occupants of single family and two (2) to four (4) family residential units must do the following for the preparation and collection of the separated materials specified in Paragraph I:

Aluminum Containers must be rinsed and placed in the Curbside Recycling Automated Cart for curbside collection on the day designated for collection;

Automobile Waste Tires, not to exceed four (4) in number per visit and/or curbside collection. Automobile Waste Tires must be taken to the Recycling Facility. A curbside pickup may be scheduled by calling the Public Works Department, or recycled wherever tires were purchased. Automobile Waste Tires that are still attached to the rim will not be accepted at the Recycling Facility and/or curbside collection;

Bimetal Containers must be rinsed and placed in the Curbside Recycling Automated Cart for curbside collection on the day designated for collection;

Corrugated Paper or Other Container Board must be broken down and flattened. Corrugated paper may be taken to the Recycling Facility, or placed in the Curbside Recycling Automated Cart for curbside collection on the day designated for collection;

Glass Containers must be rinsed with the lids removed and discarded. All colors of glass containers should be placed loosely in the Curbside Recycling Automated Cart for curbside recycling collection on the day designated for collection;

Magazines must be placed loosely in the Curbside Recycling Automated Cart and placed curbside for recycling collection on the day designated for collection;

Mixed Waste Paper must be placed loosely in the Curbside Recycling Automated Cart for curbside for recycling collection on the day designated for collection;

Newspaper must be placed loosely in the Curbside Recycling Automated Cart and placed curbside for recycling collection on the day designated for collection;

Paperboard. If applicable, plastic bag inserts must be removed and discarded. Paperboard must be placed into the Curbside Recycling Automated Cart and placed curbside for recycling collection on the day designated for collection;

Rigid Plastic Containers must have caps removed and discarded, must be rinsed free of product residue and collected as follows: Plastic Containers made of PETE, HDPE, PVC, LDPE, PP and PS (containers marked by SPI Code #1-7), must be placed loosely in the Curbside Recycling Automated Cart for curbside recycling collection on the day designated for collection; and

Steel Containers must be rinsed and placed loosely into the Curbside Recycling Automated Cart for curbside collection on the day designated for collection.

Electronics must be taken to a retail business that sells electronics or to the Recycling Facility.

O. Responsibilities of Owners or Designated Agents of Multiple-Family Dwellings.

1. Owners or designated agents of Multiple Family Dwellings must do all of the following to recycle the materials specified in Subsection I:

a. Provide adequate, separate containers for the Recyclable Materials.

b. Notify tenants in writing at the time of renting or leasing the dwelling and at least semiannually thereafter about the recycling program established in this Ordinance.

c. Provide for the collection of Recyclable Materials separated from the Solid Waste by the tenants and the delivery of Recyclable Materials to the Recycling Facility.

CODE OF GENERAL ORDINANCES, 2021 - KENOSHA, WISCONSIN

d. Notify tenants of reasons to reduce and recycle Solid Waste, which materials are collected, how to prepare the materials in order to meet the processing requirements, collection methods or sites, locations and hours of operation, and a contact Person or company, including a name, address and telephone number.

2. The requirements specified in Paragraph O.1. do not apply to the owners or designated agents of Multiple Family Dwellings if the Postconsumer Waste generated within the dwelling is treated at a processing facility licensed by the Department of Natural Resources that recovers for recycling the materials specified in Subsection I. from Solid Waste in as pure a form as is technically feasible.

P. Responsibilities of Owners or Designated Agents of NonResidential Facilities and Properties.

1. Owners or designated agents of Nonresidential Facilities and Properties must do all of the following to recycle the materials specified in Subsection I:

- a. Provide adequate, separate containers for the Recyclable Materials.
- b. Notify in writing, at least semiannually, all users, tenants and occupants of the Nonresidential Facilities and Properties about the Recycling Program established in this Ordinance.
- c. Provide for the collection of Recyclable Materials separated from the Solid Waste by the users, tenants and occupants and the delivery of the Recyclable Materials to a Recycling Facility.
- d. Notify users, tenants and occupants of reasons to reduce and recycle Solid Waste, which materials are collected, how to prepare materials in order to meet the processing requirements, collection methods or sites, locations and hours of operation, and a contact Person or company, including a name, address and telephone number.

2. The requirements specified in Paragraph 1. do not apply to the owners or designated agents on Nonresidential Facilities and Properties if the Postconsumer Waste generated within the facility or property is treated at a processing facility licensed by the Department of Natural Resources that recovers for recycling the materials specified in Section I. from Solid Waste in as pure a form as is technically feasible.

Q. Prohibitions on Disposal of Recyclable Materials Separated for Recycling. No Person may dispose of in a Solid Waste Disposal Facility, or burn in a Solid Waste Treatment Facility, any of the materials specified in Subsections I. which have been separated for recycling, except Waste Tires may be burned with energy recovery in a Solid Waste Treatment Facility in compliance with Federal, State and City laws, rules and regulations.

R. Placing Items out for Collection Too Early. Placing items out for collection prior to 6:30 p.m. the day preceding the scheduled collection day may be deemed improperly placed; notwithstanding paragraph 16.20 A. 2, may be deemed a violation of Section 16.17 and may be collected in accordance therewith; may be collected pursuant to the provisions of this Section; and/or may result in a citation under Chapters 5 or 16 of the Code of General Ordinances.

S. Responsibility. Unless specifically stated otherwise with regard to a particular provision, all Responsible Parties associated with a property are jointly and severally liable for compliance with this ordinance.

T. Enforcement.

1. For the purpose of ascertaining compliance with the provisions of this Ordinance, any authorized officer, employee or representative of the City of Kenosha Department of Public Works, Police Department or Kenosha County Health Department may inspect Recyclable Materials separated for recycling, Postconsumer Waste intended for disposal, recycling collection sites and facilities, collection vehicles, collection areas of Multiple Family Dwellings and Nonresidential Facilities and Properties, and any records relating to recycling activities, which will be kept confidential when necessary to protect proprietary information.

2. No Person who receives curbside Solid Waste collection may refuse access to any authorized officer, employee or representative of the City of Kenosha Department of Public Works, Police Department or Kenosha County Health Department who requests access for purposes of inspection, and who presents appropriate credentials. No person may obstruct, hamper, or interfere with such an inspection. Failure to allow inspection or obstructing, hampering, or interfering with such an inspection, pursuant to this paragraph T.4 may result in revocation or suspension of future curbside collection by decision of the Board of Public Works. Prior to revoking or suspending curbside collection, the Board of Public Works must provide notice of a hearing on the matter and give the Responsible Party an opportunity to be heard.

3. Any Person who violates a provision of this Ordinance may be issued a citation by an authorized officer,

CODE OF GENERAL ORDINANCES, 2021 - KENOSHA, WISCONSIN

employee or representative. The issuance of a citation will not preclude the City from proceeding under any other Ordinance or law relating to the same or any other matter. Proceeding under any other Ordinance or law relating to the same or any other matter will not preclude the issuance of a citation under this paragraph.

4. Penalties for violating this Ordinance may be assessed as follows:

a. Any Person who violates Subsection P. may be required, upon conviction, to forfeit not more than Fifty Dollars (\$50.00) for a first violation, Two Hundred Dollars (\$200.00) for a second violation, and Two Thousand Dollars (\$2,000.00) for a third and subsequent violation, plus the costs of prosecution.

b. Any Person who violates a provision of this Ordinance, except Subsection P., may be required, upon conviction, to forfeit not less than Ten Dollars (\$10.00), nor more than One Thousand (\$1,000.00) Dollars for each violation, plus the costs of prosecution.

5.12 PENALTIES

Any person, firm, party or corporation violating any of the provisions of this Chapter, or rules, regulations, or standards made pursuant thereto, shall upon conviction pay a forfeiture not to exceed One Thousand (\$1,000.00) Dollars, together with the costs of prosecution, and in default of such payment shall be committed to the County Jail for a period not to exceed ninety (90) days. Each day of violation shall be a separate offense.

CODE OF GENERAL ORDINANCES, 2021 - KENOSHA, WISCONSIN

**APPENDIX - TABLE 1
MEDIUM & LARGE VEHICLE PARKING DESIGN STANDARDS**

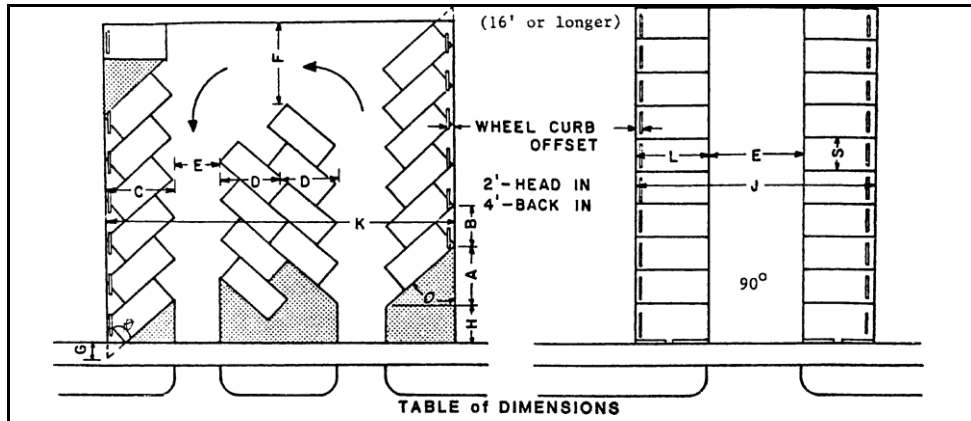

	S	L	A	B	C	D	E	F	G	H	J	K
0°	9.0	25	0.0	25	9.0	9.0	10.0		0.0	0.0	28.0	
20°	9.0	18	41.0	26.0	15.0	14.0	9.5		22.8	4.0	39.5	77.0
	9.5	18	41.0	28.0	15.0	14.5	9.5		23.8	4.0	39.5	77.0
	10.0	18	42.5	29.0	15.5	15.0	9.0		24.8	4.0	40.0	79.0
30°	9.0	18	30.0	18.0	16.5	13.0	9.5		13.5	6.0	42.5	78.0
	9.5	18	30.0	19.0	17.0	13.5	9.0		14.3	6.0	43.0	79.0
	10.0	18	30.5	20.0	17.5	13.5	9.0		14.8	6.0	44.0	80.0
40°	9.0	18	22.5	14.0	19.0	15.0	10.0		8.3	8.0	48.0	88.0
	9.5	18	22.5	15.0	19.0	15.0	10.0		8.8	7.5	48.0	88.0
	10.0	18	23.0	15.5	19.5	15.5	9.5		9.0	7.0	48.5	88.0
45°	9.0	18	20.0	12.5	19.0	16.0	10.0	16.0	6.4	9.0	48.0	90.0
	9.5	18	20.0	13.5	19.5	16.5	9.0	16.5	6.8	8.5	48.0	90.0
	10.0	18	20.5	14.0	20.0	16.5	9.0	17.0	7.0	8.0	49.0	90.0
50°	9.0	18	17.0	12.0	20.0	17.5	10.5	16.5	5.5	10.0	50.5	96.0
	9.5	18	17.0	12.5	20.5	18.0	10.0	16.5	5.8	9.5	51.0	97.0
	10.0	18	17.0	13.0	20.5	18.0	10.0	17.0	6.0	9.0	51.0	97.0
60°	9.0	18	12.0	10.5	20.5	18.0	17.0	15.0	2.6	12.0	58.0	111.0
	9.5	18	12.5	11.0	21.0	18.0	16.0	15.0	2.8	11.5	58.0	110.0
	10.0	18	12.5	11.5	21.0	18.0	15.0	15.0	2.9	11.0	57.0	108.0
70°	9.0	18	7.5	9.5	20.5	18.0	18.5	17.0	1.0	14.0	59.5	114.0
	9.5	18	7.5	10.0	21.0	18.0	17.5	17.0	1.0	13.5	59.5	114.0
	10.0	18	7.5	10.5	21.0	18.5	17.0	17.0	1.0	13.0	59.0	113.0
80°	9.0	18	3.5	9.0	20.0	17.5	23.0	18.0	0.3	16.0	63.0	121.0
	9.5	18	3.5	9.5	20.0	17.5	22.0	18.0	0.3	15.5	62.0	119.0
	10.0	18	3.5	10.0	20.0	17.5	22.0	18.0	0.3	14.5	62.0	119.0
90°	9.0	18	0.0	9.0								120.0
	9.5	18	0.0	9.5								118.0
	10.0	18	0.0	10.0								116.0

CODE OF GENERAL ORDINANCES, 2021 - KENOSHA, WISCONSIN

APPENDIX - TABLE 2 - SMALL VEHICLE PARKING DESIGN STANDARDS

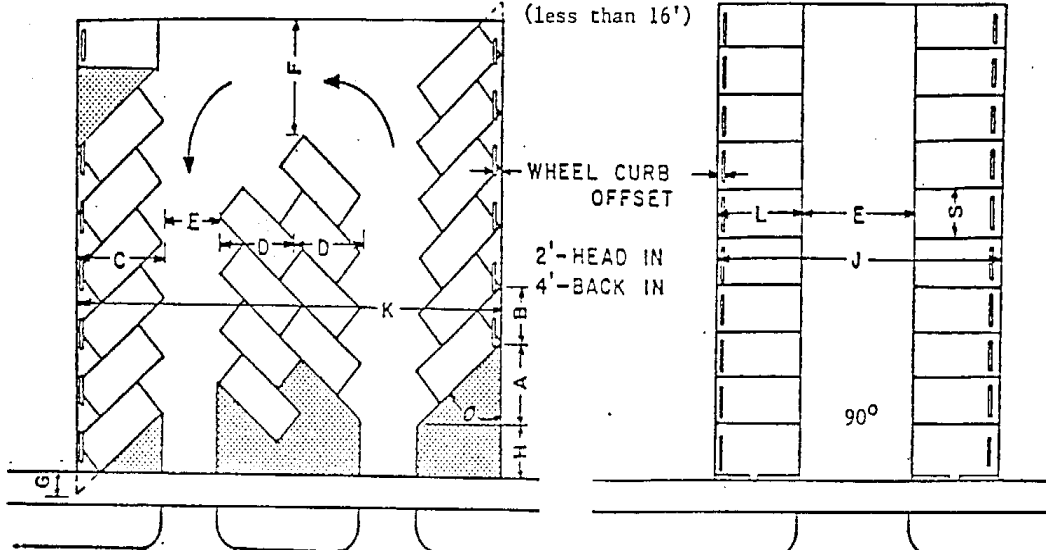

TABLE of DIMENSIONS

θ	S	L	A	B	C	D	E	F	G	H	J	K
0°	7.5	20	0.0	20.0	7.5	7.5	9.0		0.0	0.0	24.0	
	8.0	21	0.0	21.0	8.0	8.0	8.5		0.0	0.0	24.5	
	8.5	22	0.0	22.0	8.5	8.5	8.0		0.0	0.0	25.0	
20°	7.5	16	36.0	22.0	12.0	9.0	9.0		18.2	3.5	33.0	60.0
	8.0	16	37.5	23.5	12.5	9.0	8.5		19.8	3.5	33.5	60.0
	8.5	16	39.0	25.0	13.0	9.5	8.5		21.8	3.5	34.5	62.0
	9.0	16	40.5	26.0	13.0	10.0	8.5		22.8	3.5	34.5	63.0
	9.5	16	42.0	27.0	13.5	10.5	8.0		23.8	3.5	35.0	64.0
30°	7.5	16	25.0	15.0	14.0	11.0	9.5		11.0	5.5	37.5	69.0
	8.0	16	26.0	16.0	14.5	11.5	9.0		12.0	5.5	38.0	70.0
	8.5	16	27.0	17.0	15.0	12.0	8.5		12.5	5.5	38.5	71.0
	9.0	16	28.0	18.0	15.5	12.5	8.0		13.5	5.5	39.0	71.0
	9.5	16	28.5	19.0	16.0	13.0	8.0		14.3	5.5	40.0	74.0
40°	7.5	16	19.0	11.5	16.0	13.0	10.0		6.8	8.0	42.0	78.0
	8.0	16	19.5	12.5	16.0	13.5	10.0		7.3	7.5	42.0	79.0
	8.5	16	20.0	13.0	16.5	14.0	9.0		7.8	7.5	42.0	79.0
	9.0	16	20.5	14.0	17.0	14.0	8.5		8.3	7.0	42.5	79.0
	9.5	16	21.0	15.0	17.0	14.5	8.5		8.8	6.5	42.5	80.0
45°	7.5	16	17.0	10.5	16.5	14.0	10.0	13.0	5.2	9.0	43.0	81.0
	8.0	16	17.0	11.0	17.0	14.0	9.5	13.5	5.7	8.5	43.5	81.0
	8.5	16	17.5	12.0	17.0	14.5	9.5	14.0	6.0	8.0	43.5	82.0
	9.0	16	18.0	13.0	17.5	15.0	8.5	14.5	6.4	7.5	43.5	82.0
	9.5	16	18.5	13.5	18.0	15.5	8.0	15.0	6.8	7.5	44.0	83.0
50°	7.5	16	14.5	10.0	17.0	15.0	11.0	13.5	4.5	10.0	45.0	86.0
	8.0	16	15.0	10.5	17.5	15.0	10.5	14.0	4.9	9.5	45.5	86.0
	8.5	16	15.0	11.0	18.0	15.5	10.0	14.5	5.0	9.0	46.0	87.0
	9.0	16	15.5	12.0	18.0	15.5	10.0	14.5	5.5	8.5	46.0	87.0
	9.5	16	16.0	12.5	18.5	16.0	9.0	15.0	5.8	8.0	46.0	87.0
60°	7.5	16	10.0	8.5	18.0	15.5	17.0	13.0	2.0	11.5	53.0	101.0
	8.0	16	10.5	9.0	18.0	16.0	16.5	13.0	2.3	11.5	52.5	101.0
	8.5	16	10.5	10.0	18.0	16.5	16.0	13.0	2.5	11.0	52.0	101.0
	9.0	16	11.0	10.5	18.5	16.5	15.5	13.0	2.8	10.5	52.0	101.0
	9.5	16	11.0	11.0	18.5	17.0	15.0	13.0	2.8	10.0	52.0	101.0
70°	7.5	16	6.5	8.0	18.0	16.0	18.0	15.0	1.0	13.5	54.0	104.0
	8.0	16	6.5	8.5	18.0	16.5	17.0	15.0	1.0	13.0	53.0	103.0
	8.5	16	6.5	9.0	18.0	16.5	17.0	15.0	1.0	12.5	53.0	103.0
	9.0	16	6.5	9.5	18.5	17.0	16.0	15.0	1.0	12.0	53.0	103.0
	9.5	16	6.5	10.0	18.5	17.0	16.0	15.0	1.0	11.5	53.0	103.0
80°	7.5	16	3.0	7.5	18.0	16.5	24.0	16.0	0.3	15.5	60.0	117.0
	8.0	16	3.0	8.0	18.0	16.5	22.0	16.0	0.3	15.5	58.0	113.0
	8.5	16	3.0	8.5	18.0	16.5	21.0	16.0	0.3	14.5	57.0	111.0
	9.0	16	3.0	9.0	18.0	17.0	20.0	16.0	0.3	14.0	56.0	110.0
	9.5	16	3.0	9.5	18.0	17.0	19.0	16.0	0.3	13.0	55.0	108.0
90°	7.5	16	0.0	7.5	16.0	16.0	25.0	18.0	0.0	0.0	57.0	114.0
	8.0	16	0.0	8.0	16.0	16.0	23.0	18.0	0.0	0.0	55.0	110.0
	8.5	16	0.0	8.5	16.0	16.0	22.0	18.0	0.0	0.0	54.0	108.0
	9.0	16	0.0	9.0	16.0	16.0	21.0	18.0	0.0	0.0	53.0	106.0
	9.5	16	0.0	9.5	16.0	16.0	20.0	18.0	0.0	0.0	52.0	104.0

CODE OF GENERAL ORDINANCES, 2021 - KENOSHA, WISCONSIN

CHAPTER VI PARKS

6.01 PARKS

A. Definitions.

1. The phrase "Dog Park" means a portion of a park that has been designated by the Board of Park Commissioners for use by the public to exercise dogs off-leash and that is enclosed by a fence.

2. The words "Park" or "Parks" mean all land and water heretofore and hereafter acquired by the City for park or recreational purposes which are under the jurisdiction of the Board of Park Commissioners. Such land and water shall collectively be known as the Park System.

B. Board Of Park Commissioners. The Board of Park Commissioners is empowered and directed to govern, manage, control, improve and care for all public parks, parkways, boulevards and pleasure drives located within, or partly within and without, the corporate limits of the City, and secure the quiet, orderly and suitable use and enjoyment thereof by the people; to adopt rules and regulations not in conflict with these ordinances to promote those purposes; and to exercise such other powers conferred by §27.08, Wisconsin Statutes.

6.02 RULES AND REGULATIONS

No persons, other than authorized employees, agents, contractors and permittees of the City, shall engage in any of the following conduct:

A. Parks.

1. Dump or deposit any garbage, waste, trash or debris in other than an appropriately marked container.

2. Dump or deposit debris, leaves, grass trimmings, brush, trees or branches.

3. Dump or deposit any household or commercially generated garbage, waste, trash or debris, which are not generated through park use, in any container designated for any of the above.

4. Remove any fixture, furniture, sand, stone, rock, dirt, tree, shrub, fern, flower or other property.

5. Destroy, break, injure, mutilate or deface any building, structure, monument, statue, fountain, pool, dock, wall, fence, fixture, furniture, tree, shrub, plant, fern, flower or other real or personal property.

6. Bring or ride any animal or animal drawn vehicle, other than for licensed Horse Drawn Vehicles.

7. Operate any snowmobile or all-terrain vehicle.

8. Operate any motor vehicle, bicycle, or horse drawn vehicle on other than designated streets and thoroughfares.

9. Park any motor vehicle, bicycle or horse drawn vehicle in other than a designated parking space or for longer than the posted time limits.

10. Operate any motor vehicle, bicycle or horse drawn vehicle in a reckless, unreasonable or imprudent manner, contrary to the provisions of Sections 346.61 and 346.62, Wisconsin Statutes, or in excess of fifteen (15) miles per hour, except on a public street having a higher speed limit.

CODE OF GENERAL ORDINANCES, 2021 - KENOSHA, WISCONSIN

11. Light or make use of any fire, except for cooking in areas and containers designated for such purpose. Cooking in picnic areas is permitted in portable metal containers where the base of the fire is twelve (12) or more inches off the ground or where the container is placed on bare earth. It is also unlawful to light or make use of any fire or place or deposit hot ashes in a manner which could cause the fire to be a danger to person or property.

12. Climb a tree or walk upon any wall or fence.

13. Enter any portion of a park where persons are prohibited from going by direction of the Director of Parks, given in person or indicated by sign or written notice.

14. Perform any act prohibited by direction of the Director of Public Works or designee/Superintendent of Parks, given in person or indicated by sign or written notice.

15. Enter any area, structure or building which is under construction or fenced, locked or secured to prohibit entry or posted with No Trespassing Signs.

16. Enter any portion of the City golf course when not lawfully engaged in the playing of golf.

17. Ice skate in other than a designated ice rink or ice skate in an improper, unreasonable or imprudent manner.

18. Sell, give away, possess or consume any alcoholic beverage, except as follows:

(1) The possession and drinking of fermented malt beverages and wine shall be allowed in City Parks and buildings, provided that persons and groups obtain a permit issued pursuant to Section 6.05 of this chapter for the date for which said person or group requests a permit. Permits received pursuant to this subsection shall expire at 10:00 P.M. of each day, unless otherwise provided by the Superintendent of Parks or designee.

(2) The sale and giving away of fermented malt beverage or wine is permitted only by persons and groups appropriately licensed under State Law and local ordinance.

(3) The sale and consumption of alcoholic beverages is permitted at Simmons Island Beachhouse, provided that the location is appropriately licensed under State law and local Ordinance.

19. Be or remain in any City Park between 10:00 P.M. and the sunrise of the following day, except with the express written permission of the Superintendent of Parks. The Superintendent of Parks may permit individual persons or groups of persons having a common purpose to remain in one or more designated park(s) for some or all of the hours between 10:00 P.M. and the sunrise of the following day in the event of special events open to the general public such as, but not limited to, 4th of July celebrations, and in the event any group or individual desires to engage in fishing. Persons engaged in fishing shall, between 10:00 P.M. and the sunrise of the following day, use only such portions of City parks as are reasonably necessary for fishing purposes. The Superintendent of Parks may authorize overnight parking as required to serve the Simmons Island and Southport Marina.

20. Fly any real or scale model, or miniature or U-control, or remote control or hot air balloon, propeller driven or jet aircraft or any rocket powered craft.

21. Sell or offer for sale any product, articles, food, beverages, goods or services except as follows:

(a) Upon written request, the Board of Park Commissioners may allow the sale of any product, articles, food, beverages, goods or services provided that the applicant, when necessary, is appropriately licensed under state statute and local ordinance. In considering a request, the Board of Park Commissioners shall consider whether the proposed transactions are:

(1) Are customarily associated with public use and enjoyment of parks and park properties;

CODE OF GENERAL ORDINANCES, 2021 - KENOSHA, WISCONSIN

- (2) Are in furtherance of public use and enjoyment of the park; or
- (3) Are incidental to an appropriate recreational or cultural use of said properties.
- (b) Sales permitted pursuant to subsection (a) shall be subject to the following requirements:
 - (1) Location. Permission shall be limited to the location designated by the Board of Park Commissioners.
 - (2) Hours of Operation. Permission to sell or offer for sale shall be limited to the hours between 9:00 a.m. and 8:00 p.m.
 - (3) Term. Permission shall be limited to no more than thirty (30) consecutive days.
 - (4) Special Events. Vendors associated with special events which have received the required approval to be located in City Parks shall not be required to obtain a peddler stand permit for the special event.
 - (5) Utilities. Vendors which require use of public utilities shall be required to pay utility fees as designated by the Superintendent of Parks.
 - (6) Noise. Noise levels emanating from the stand shall be kept to a minimum and shall be reasonable so as not to disturb the peace and quiet of those in the vicinity, including but not limited to residents, merchants and customers. Vendors shall be subject to all applicable City ordinances regarding noise and amplification and this ordinance shall not be interpreted to expand or contradict those other ordinances. In the event of a conflict, the more strict regulation or ordinance shall apply.
- 22. Post or install any notice, advertisement, decoration, sign or banner.
- 23. Place any structure or construction materials or make any improvement.
- 24. String or hang any wire, rope, cable or cord.
- 25. Park or maintain any motor vehicle, bicycle or horsedrawn vehicle beyond park closing hours, except as authorized in this Ordinance.
- 26. Use of a skateboard, except in an area designated therefor.
- 27. Use of roller skates and roller blades in an area designated and marked as a no roller skating/roller blading area.
- 28. Play or practice golf, except in an area designated therefor.
- 29. Play amplified music over the decibel limit specified in Chapter 23 of the Code of General Ordinances.
- 30. Play team sports in other than a designated area.
- 31. Bring or permit any animal to enter any park, except domestic animals (household pets) which are not vicious in nature, provided said animal is maintained on a secured leash of six (6') feet or less and further provided that the animals excrement is scooped immediately and removed from the park at the time of exiting the park. Notwithstanding the above, dogs located within an enclosure in a dog park may be off-leash when such is allowed by the rules of the dog park. Nothing contained herein shall authorize an animal to be brought into a park which is prohibited from being in the City under §14.02 of the Code of General Ordinances.
- 32. Sled in other than a designated area or in an unreasonable or imprudent manner.
- 33. Engage in any activity which would endanger life or property.
- 34. Perform any construction or maintenance work.

CODE OF GENERAL ORDINANCES, 2021 - KENOSHA, WISCONSIN

B. Beaches.

1. Violate any Park rule or regulation.
2. Throw, place or deposit on the beach or in the water, any lighted smoking material or hot coals or any object with a sharp or cutting surface.
3. Break any glass.
4. Use artificial floats or toys in the water, except for life vests or swimming training devices.
5. Disregard instructions or directives of any lifeguard.
6. Enter or remain in the water when an area is posted "No Swimming". Enter or remain in the water during times when swimming is not permitted. Swim more than fifty (50) yards from shore. Swim outside of markers that designate a swimming area. Enter or remain in the water within fifty (50) feet, measured in any direction, of a pier, jetty, breakwater, or seawall, or within one hundred fifty (150) feet of the mouth of the Pike River. For purposes of this prohibition, "swim" includes wade. For purposes of this prohibition, jetty means a structure that is above the water line. For purposes of this prohibition, "water" means waters of Lake Michigan adjacent to the City of Kenosha.
7. Use any lifeguard stand, boat or equipment unless authorized by lifeguard.
8. Falsely call for emergency assistance or falsely create the perception of an emergency.
9. Distract or obstruct any lifeguard who is on duty.
10. Enter the water while having any infectious or contagious disease or wearing any cast or bandage.
11. Change clothes in other than a designated beach house.
12. Dock, moor or beach any watercraft at other than designated docks, piers, buoys or beach areas.
13. Operate any watercraft in any marked swimming area or within fifty (50) yards of the shore in a designated swimming area.

C. Swimming Pools.

14. Violate any Park or Beach rule or regulation.
15. Bring food, drink, gum or smoking products into any pool or deck area.
16. Enter any pool prior to taking a soap and water shower or using foot baths, where available.
17. Enter any pool in other than a swimming suit or enter deck area in street shoes.

D. Playgrounds

For the playground area in Petzke Park that is delineated by a fence, in addition to all other applicable rules relating to parks, the following activities are unlawful for any person:

1. to enter into, remain in, or permit a child under the supervision of the person, to enter into or remain in the playground between 8:00 P.M. and the 7:00 A.M. of the following day;
2. to bring food, drink, chewing gum, smoking products, which includes vaping products, into the playground;
3. to wear spiked shoes or any foot attire that is likely to puncture safety surfaces; or
4. to disobey any rules created by the Parks Superintendent that are posted or disobey orders given by the Parks Superintendent or any law enforcement officer.

6.03 EMERGENCY CLOSING OF PARKS

In time of actual or potential civil unrest or when the public interest so requires, any City park or parks may be closed as follows: **(i)** The Mayor may proclaim any City park(s) closed for all or a portion of any day or days by issuing an oral or signed written order so stating, which order shall be made public by such means as are expedient at the time. Oral orders of the Mayor shall be effective until the Park Commission shall next meet at a regularly scheduled or at a special meeting called to discuss this subject. **(ii)** The Park Commission may proclaim any City park(s) closed for all or a portion or any day or days by issuing a written order signed by the Chairman or Acting Chairman of the Park Commission or by the

CODE OF GENERAL ORDINANCES, 2021 - KENOSHA, WISCONSIN

Superintendent of Parks where the Park Commission so authorizes, which written order shall be made public by such means as are expedient at the time. Such orders shall not be effective for longer than ninety (90) days without the approval of the Common Council.

6.04 RULES FOR THE DESIGNATION AND MAINTENANCE OF NAMES FOR PUBLIC PARKS AND RECREATIONAL AREAS

A. Official Names Defined. The names of Parks and Recreational Facilities are recognized only if recommended by the Board of Park Commissioners ("Board") and approved by the Common Council ("Official Name(s)"). A Park or Recreational Facility not having an Official Name shall be considered unnamed.

B. Official Names Recognized. The following names existing as of January 1, 2004, are recognized as Official Names, irrespective of the naming/renaming procedure followed.

1. The Official Names of Parks are:

- a. Alford Park
- b. James R. Anderson Park
- c. Bain Park
- d. Robert V. Baker Park
- e. H.L. Bullamore Park
- f. Yolanda Cicchini Park
- g. Kenosha Civic Center Park
- h. Columbus Park
- i. Davis Park
- j. Eichelman Park
- k. Elmwood Park
- l. Endee Park
- m. Fire House Square
- n. Forest Park
- o. Friendship Park
- p. Gangler Park
- q. Joseph Hobbs Park
- r. William W. Isetts Park
- s. Jamestown Park
- t. Johnson Highlands
- u. Kenfair Park
- v. John Fitzgerald Kennedy Park
- w. Kirchner Highlands
- x. Public Square Central Park (Library Park)
- y. George Limpert Park
- z. Lincoln Park
- aa. Little League Park
- bb. Chester S. Matoska Park
- cc. Nash Park
- dd. Veterans Memorial
- ee. Navy Memorial Park Annex
- ff. Peter P. Nedweski Park
- gg. Newman Park
- hh. Pennoyer Park
- ii. Frank J. Petretti Park
- jj. Petzke Park
- kk. Pike Lodge Park
- ll. Red Arrow Memorial Park
- mm. Roosevelt Park
- nn. Sam Poerio Park

CODE OF GENERAL ORDINANCES, 2021 - KENOSHA, WISCONSIN

- oo. Bill Schulte Park
- pp. Senior Citizens' Park
- qq. Simmons Island Park
- rr. Southport Park
- ss. Strawberry Park
- tt. Cornelia Hamilton Streeter Park
- uu. Sunnyside Park
- vv. Tot Park
- ww. Tower Line Park
- xx Union Park
- yy. Washington Park
- zz. Werves Park
- aaa. Wolfenbüttel Park
- bbb. Dr. James Santarelli Park

2. The Official Names of Recreational Facilities are:

- a. Washington Park Municipal Golf Course.
- b. Simmons Island Marina.
- c. Simmons Athletic Field.

C. Subdivision Plats and Land Divisions. Parks and Recreational Facilities shall not be named in a subdivision plat or any other instrument of land division.

Subdivision plats and other instruments of land division may only refer to a Park as "Park" or "Park Land", unless the Park has been first named in accordance with this Ordinance.

D. Naming. A Park or Recreational Facility may be named if new or unnamed.

E. Renaming. The renaming of a Park or Recreational Facility will be considered only when the Official Name is no longer appropriate.

The procedure to rename a Park or Recreational Facility shall not commence until such a finding is made by a two-thirds (2/3rds) vote of the membership of the Board and the Common Council.

F. Procedure for Naming/Renaming. The following procedure will govern naming or renaming:

1. The Board will identify Parks and Recreational Facilities to be named or renamed.
2. The Board will post this information as a Public Notice in the official City newspaper and on the City website, along with any procedure and timetable it may establish.
3. The Board will receive input for a minimum of thirty (30) days from public bodies, professional organizations, community and civic groups and organizations, and by petition where petitioners have submitted a written petition signed by no less than one hundred (100) City residents.
4. The Board will place this item on the agenda of a regularly scheduled meeting. The Board will consider names submitted and names recommended by its members.
5. The Board shall submit a list of all names considered to the City Plan Commission with a request for a recommendation. The Common Council will be sent notice of the pending matter. If the City Plan Commission does not act within the time frame determined by the Board, the Board will act without its recommendation.
6. The Board shall not act upon the matter for a minimum of sixty (60) days.
7. Before acting on the matter, the Board shall post all names being considered on the City website and in the official City newspaper, along with the date of the Board meeting at which this matter may be

CODE OF GENERAL ORDINANCES, 2021 - KENOSHA, WISCONSIN

acted upon. The Board may defer this matter to other meeting dates without publishing or posting a new notice.

8. The recommendation of the Board will be forwarded to the Common Council for action. If the Board does not recommend a name by a majority of its full membership, the matter shall not be considered by the Common Council.

9. The Board and Common Council must approve the name/renaming by a majority vote of their membership.

G. Names and Renaming Guidelines. The following guidelines will govern the naming and renaming of Parks or Recreational Facilities:

1. Names which reference or include geographical location, geological features or historic information are encouraged.

2. Names may not be of individuals unless deceased for a minimum period of three (3) years; unless the individual made a major effort or donation for the acquisition or improvement of the Park or Recreational Facility in specific or of the Park system in general.

3. Names may not be of individuals then serving in any elected or appointed public office or position.

4. Names may not be of community or civic groups or organizations unless the group or organization made a major effort or donation for the acquisition or improvement or use of the Park or Recreational Facility.

H. Other Recognition. The Board shall have the exclusive jurisdiction, without the limitations or procedural requirements of the foregoing, to:

1. Name any area, feature or building, structure, tree or landscaped area, of any Park or Recreational Facility.

2. Permit any person, group, organization or legal entity to donate a building, structure, tree or landscaped area in any Park or Recreational Facility, and to commemorate the donation with a plaque or monument recognizing the donor.

6.05 PERMITS

A. Permits Required. A permit shall be required under this Ordinance prior to and as a condition of any person, party, firm or corporation undertaking any of the following activities:

1. Hold any assembly or gathering of two hundred fifty (250) or more persons.
2. Engage in organized athletic competition or team sports.
3. Reserve any athletic field for a date and time certain.
4. Reserve any picnic area for a date and time certain.
5. Sell food, beverage or any other product or service.
6. Possess and consume fermented malt beverages and/or wine.
7. Perform any act, otherwise prohibited.
8. Produce amplified sound in excess of decibel limit specified in Chapter 23 of the Code of General Ordinances.
9. Special Events as defined in Section 12.06 shall be permitted pursuant to that section in lieu of a permit defined herein.

The failure to obtain such permit shall be deemed a violation of this Ordinance.

B. Application. Application for any permit above provided shall be made to the Superintendent of Parks in writing, and accompanied by the required fee. Such application shall be fully completed on City

CODE OF GENERAL ORDINANCES, 2021 - KENOSHA, WISCONSIN

forms and shall define the activity desired to be engaged in, the park(s) or park area where the activity will be performed, the estimated attendance and other relevant information requested on the application form which is reasonably necessary to a fair determination as to whether the permit should be issued. The Board of Park Commissioners shall, from time to time, establish a written policy for the minimum and maximum time for submitting applications for activities subject to a permit on an activity-by-activity basis.

C. Permit Fees. Permit fees shall be as established by the Board of Park Commissioners, and kept on file in the Department of Public Works.

D. Leases And Concessions. Leases and Concession Agreements shall be subject to bids, requests for proposals or negotiated terms and conditions, reduced to a contract, reviewed and approved by the City Attorney as to form, and approved by the Board of Park Commissioners.

E. Permitting Authority.

1. Board Of Park Commissioners. The Board of Park Commissioners shall be responsible for granting leases, concession agreements, permits for a gathering of two hundred fifty (250) or more persons, for special events involving the sale or consumption of fermented malt beverages, and for determination of fees and charges.

2. Director Of Parks. The Superintendent of Parks may grant any other permit or allow any activity authorized by this Ordinance, subject to a monthly report of permits being filed with and subject to the payment of fees and charges authorized by the Board of Park Commissioners. The decision of any of the above may be appealed to the Board of Park Commissioners.

F. Standards For Permit Issuance. The Permitting Authority shall consider the following standards for permit issuance and grant a permit only upon finding that:

1. The activity or use will be in compliance with applicable Federal, State, County and City laws, rules and regulations.

2. The activity or use will not create an unreasonable risk of loss of life, personal injury or property loss or damage or otherwise threaten the public health, safety or welfare.

3. The activity or use will not unreasonably interfere with the use of the park by the general public.

4. The activity or use will not entail an unusual, extraordinary or burdensome expense to the City which is not recovered in the permit fees or charges.

5. The area which is the subject of the application is not reserved for another use or party at the day and hour for which requested.

6. The area requested is an area designated by the Board of Park Commissioners for the type of use requested and is otherwise available for use.

7. Other considerations:

a. Applications, where timely filed, shall be considered in order of priority determined by Permitting Authority, with due consideration for the need to distribute scarce resources on an equitable basis.

b. A permit shall not be denied where the activity constitutes free speech or right of assembly protected by the United States or Wisconsin Constitution, provided the above standards can be met.

c. The Board of Park Commissioners shall retain the right to reserve any park or area for any civic function or Commission sponsored event.

Whenever a permit application is denied, a statement of the reason(s) for denial shall be provided to the applicant in writing.

G. Permit Conditions. The Permitting Authority shall have the right to impose reasonable permit

CODE OF GENERAL ORDINANCES, 2021 - KENOSHA, WISCONSIN

conditions, including, but not limited to, the following:

1. Compliance with applicable Federal, State, County and City laws, rules and regulations.
2. Compliance with this Ordinance.
3. Execution of Indemnity and Hold Harmless Agreement.
4. Post a bond or other assurance to guarantee compliance with permit terms and conditions.
5. Provide private security for traffic, parking and/or crowd control.
6. Hold City harmless from damage to its property.
7. Clean up area immediately following use.
8. Inspect the Park Area immediately prior to Park use to determine whether or not the Park Area is suitable and safe for such use. If such inspection reveals that such Park Area is not suitable and safe for the intended use, the Park Area shall not be used until the Park Area is made suitable and safe for such use.
9. Report unsafe conditions in the Park Area to the Department of Public Works.
10. Warn all persons using the Park Area under authority of the Park Use Agreement of any unsafe conditions which may exist or portions of Park Area which are not suitable for use.
11. Supervise all persons using the Park Area under authority of the Park Use Agreement.
12. Reimbursement to City of costs incurred in enforcing permit forms and conditions.
13. Procure and maintain one (1) or more liability insurance policy(ies) written by one (1) or more insurance company(ies) licensed to do business in the State of Wisconsin, which contain an endorsement of contractual liability, and which covers death, personal injury and property damage in the following amounts:
 - a. **CLASS I RISK** - \$1,000,000 for events and activities which involve a moderate risk, a noncommercial activity, and/or a gathering of less than five hundred (500) persons.
 - b. **CLASS II RISK** - \$1,000,000 for events and activities which involve a moderate liability risk or a commercial activity, or a gathering of more than five hundred (500) persons.
 - c. **CLASS III RISK** - Over \$1,000,000, as determined by the Park Commission, for events and activities which involved a high liability risk, specifically including, but not limited to, circuses and carnivals.
14. Procure any other license or permit required for activity, such as Food Permit or Special Class "B" License.

H. Revocation, NonRenewal and Suspension of Permits. The Permitting Authority may authorize and for just cause suspend, revoke, or not renew any permit herein provided, upon serving upon such party written notice of the charges forming a basis for the proposed penalty, in the same manner as that for the service of a Summons in a civil action. Said notice shall provide for a hearing upon a written request therefor being filed with the City Clerk within ten (10) days of service. Absent a timely request for a hearing, the Permitting Authority shall administratively impose the penalty set forth in said notice.

The judgment of conviction of any permittee in any Municipal, State or Federal Court, irrespective of whether obtained following trial, plea agreement, or bond forfeiture, shall be prima facie proof of said violation for purposes of this Ordinance. However, in the instance of any judgment of conviction entered pursuant to a no contest plea, or considered in law to be rendered pursuant to a no contest plea, said judgment of conviction as a prima facie case may be rebutted. Further, mitigating circumstances may be introduced with respect to any judgment of conviction.

CODE OF GENERAL ORDINANCES, 2021 - KENOSHA, WISCONSIN

I. Time Limits. The following time limits shall apply in the application of this Section:

1. Board of Park Commissioners to act on Permit Application: Thirty (30) days.
2. Superintendent of Parks to act on Permit Application: Ten (10) days.
3. Appeal of any permitting decision of the Superintendent of Parks to the Board of Park Commissioners: Ten (10) days from actual receipt or twelve (12) days from date of postmark, whichever is longer.

6.06 PROTECTION OF BEACHES

The deposits of sand, gravel, earth and stone along the shore of Lake Michigan north and south of the harbor, lying within a distance of one hundred fifty (150') feet west of the water line of Lake Michigan and not over fifteen (15') feet above the level of the lake, and all such deposits lying in the lake east of said water line within a distance of six hundred (600') feet are hereby declared to be necessary for the protection of the City of Kenosha and the harbor of the City from the encroachments of Lake Michigan. No person, firm or corporation except the City of Kenosha and persons authorized by the Director of Public Works shall dig, take, remove or carry away sand, gravel, earth or stone from the beach within the limits, described or from the water within six hundred (600') feet of the water line along or near the shore of said lake between the north and south harbor piers, and the extreme northern and southern limits of the city.

6.065 NATURE AREAS

A. Definition.

1. A Nature Area is an area within the City that: (1) is protected in order to preserve a natural habitat for local flora and fauna; and (2) is designated by the Common Council as a Nature Area. A designated Nature Area may, but does not necessarily have to be, a park.

2. Poerio Nature Center is that portion of Poerio Park more particularly designated as a trapezoid having a north line established by the north line of parcel 10-223-18-276-001 extending from the western line of the Union Pacific right of way to the eastern line of the 20th Avenue right of way; an east line established by the east right of way of 20th Avenue; the southern line established by the southern line of parcel 10-223-18-240-001 extended from the east right of way of 20th Avenue to the western line of the Union Pacific right of way; and an east boundary established by western line of the Union Pacific right of way.

3. Phil Sanders Nature Area is the entirety of "Parkland" (comprising of approximately 54.66 acres), "Gateway Center Park" (comprising approximately 5.18 acres), and "Phil Sanders Park" (comprising approximately 5.18 acres) each of which are designated on the City of Kenosha Comprehensive Outdoor Recreation Plan dated July 2011; for the avoidance of doubt, the Phil Sanders Nature Area comprises three identified areas which are unimproved, City-owned land extending from 60th Street to 75th Street, but excludes Horizons Park as that latter park is also designated on the Comprehensive Outdoor Recreation Plan.

B. Designation.

The following are designated as Nature Areas: Poerio Nature Center and Phil Sanders Nature Area.

C. Regulation.

The following regulations are applicable to Nature Areas:

1. No one may be or remain in any Nature Area between 10:00 P.M. and sunrise of the following day, except with the expressed, written permission of the Director of Public Works.
2. Special events require a permit pursuant to sections 5.06, 6.05, or 12.06, as applicable.
3. Visitors are required to stay on trails, where designated.
4. Bicycles are only permitted on trails marked for bicycle use.
5. Alcohol beverages are not permitted.

CODE OF GENERAL ORDINANCES, 2021 - KENOSHA, WISCONSIN

6. Littering or dumping of debris is not permitted.
7. Collection of any plant, animal, or other substance is not permitted except with the expressed, written permission of the Director of Public Works.
8. Intentional introduction of macroscopic flora or fauna is not permitted.
9. No defacing, injuring, disturbing, or destroying any property is permitted.
10. Hunting or trapping in nature areas is not permitted.
11. Kindling or perpetuation of fires is not permitted.
12. Climbing of trees is not permitted.
13. Camping is not permitted except with the expressed, written permission of the Director Of Public Works.
14. Sound amplifying devices are not permitted.
15. No drone flying, model rocket launching, remote controlled vehicles, or model aircraft, in or over a Nature Area is permitted.
16. Motorized vehicles are not permitted unless such vehicles are necessary to provide accessibility pursuant to the Americans with Disabilities Act.
17. To the extent that any regulation in this Section 6.065 conflicts with any statute, ordinance, or any other regulation applicable, the more restrictive regulation applies.

6.07 BOULEVARDS

A. Prohibited Uses. It shall be unlawful for any person to engage in the following activities on a City boulevard parkway:

1. To engage in organized or unorganized sports.
2. To throw, kick or pass any ball or object, whether natural or man made.
3. To engage in play involving running or shouting.
4. To permit any animal to enter, be, or remain thereon.

6.08 DUMPING OF ICE OR SNOW ON PARK PROPERTY

A. Prohibition. No person, party, firm or corporation shall dump or otherwise deposit snow or ice on any Park property.

B. Exceptions. This prohibition does not apply to the City of Kenosha and its subunits, provided permission is obtained from the Superintendent of Parks.

C. Emergencies. The Commission may promulgate rules and establish fees to deal with emergency situations.

6.09 PENALTIES

For the violation of any of the provisions of this Chapter or any rule or regulation prescribed by the Board of Park Commissioners or the Superintendent of Parks, any person shall upon conviction thereof pay the forfeiture not to exceed one thousand dollars (\$1,000.00) with cost of prosecution and in default of payment of said forfeiture and cost shall be committed to the County Jail for a term not exceeding ninety (90) days.

CODE OF GENERAL ORDINANCES, 2021 - KENOSHA, WISCONSIN

CHAPTER VII TRAFFIC REGULATIONS

7.01 PROVISIONS OF STATE LAW ADOPTED BY REFERENCE

A. State Traffic Forfeiture Laws Adopted. Except as otherwise specifically provided in this Ordinance, all provisions of Chapters 340 to 348 of the Wisconsin Statutes describing and defining regulations with respect to vehicles and traffic for which the penalty is a forfeiture only, including penalties to be imposed and procedure for prosecution, are hereby adopted and by reference made a part of this Ordinance as if fully set forth therein. Any act required to be performed or prohibited by any statute incorporated herein by reference is required or prohibited by this Ordinance.

Sections of Chapters 340 to 348 adopted by reference shall include, but not be limited to, the following:

- 340.01 Words and Phrases Defined.
- 341.04 (3)(A) Penalty for Operating Unregistered or Improperly Registered Vehicle.
- 341.08 (6) Penalty for Violating Provision of Application for Registration.
- 341.11 (4) Display of Registration Plates.
- 341.15 Display of Registration Plates.
- 341.16 (4) Issuance of Duplicate Plates.
- 341.42 (4) Reciprocity Permits.
- 341.51 (5) Penalty for Failing to Apply for Dealer, Distributor or Manufacturer Registration.
- 341.55 Penalty for Misuse of Plates.
- 341.57 (3) Registration of Finance Companies and Banks.
- 341.61 Improper Use of Evidence of Registration.
- 341.62 False Evidence of Registration.
- 341.63 When Registration Is to Be Suspended.
- 342.05 (4) Certificate of Title Required.
- 342.06 (3) Taxicab Registration.
- 342.15 (5), (6) and (7) Transfer of Interest in Vehicle.
- 342.16 (3) Failure of Dealer to Transfer Title.
- 342.23 Secured Party's and Owner's Duties.
- 342.30 342.31, 342.34 Anti-theft and Anti-fraud Provisions.
- 342.33 Sale of Vehicle Used as Taxicab.
- 343.01 Words and Phrases Defined.
- 343.10 (6) Occupational License Restriction Violation.
- 343.12 (3) School Bus Operators to Obtain Special License.
- 343.125 (3) Chauffeurs to Obtain Special License.
- 343.19 (2) False Statement in Application for Duplicate License.
- 343.22 (2) Notice of Change of Address.
- 343.305 Implied Consent.
- 343.35 Surrender of Licenses upon Cancellation, Revocation or Suspension.
- 343.45 to 343.46 Unlawful Practices Relative to Licenses.
- 343.60 to 343.72 Licensing of Driver Schools and Instructors.
- 343.73 Licensing of Driver Schools and Instructors.
- 344.01 Words and Phrases Defined.
- 344.45 to 344.47 Penalties for Violation of Chapter.
- 344.51 Financial Responsibility for Domestic Rented Vehicles.
- 345.01 Words and Phrases Defined.
- 345.17 Penalty for False Statements.
- 345.20 to 345.53 General Provisions in Traffic Forfeiture Actions.
- 345.55 Traffic Officers Not to Profit from Arrests.
- 346.01 Words and Phrases Defined.

CODE OF GENERAL ORDINANCES, 2021 - KENOSHA, WISCONSIN

- 346.02 Applicability of Chapter.
- 346.03 Applicability of Rules of the Road to Authorized Emergency Vehicles.
- 346.04 (1) and (2), 346.05 to 346.16 Driving, Meeting, Overtaking and Passing.
- 346.17 Penalty for Violating §§346.04 to 346.16.
- 346.18 to 346.21 Right of Way.
- 346.22 Penalty for Violating §§346.18 to 346.21.
- 346.23 to 346.29 Drivers and Pedestrians.
- 346.30 Penalty for Violating §§346.23 to 346.29.
- 346.31 to 346.35 Turning and Stopping and Required Signals.
- 346.36 Penalty for Violating §§346.31 to 346.35.
- 346.37 to 346.42 Traffic Signs, Signals and Markings.
- 346.43 Penalty for Violating §§346.37 to 346.42.
- 346.44 to 346.88 Required Stops.
- 346.49 Penalty for Violating §§346.44 to 346.48.
- 346.57 (2), (3) and (4)(a) to (c) Speed Restrictions-First Offense in a Year.
- 346.57 (4)(d), (5) and (6) to 346.595 Speed Restrictions.
- 346.60 Penalty for Violating §§346.57 to 346.595.
- 346.61 Applicability of Sections Relating to Reckless and Drunken Driving.
- 346.62 (1) and (3) Reckless Driving-First Offense in 4 Years.
- 346.63 (1), (3) and (4) Operating under "Influence" of Intoxicant-First Offense in 5 Years.
- 346.64 Employment of Drunk Operators-first Offense in a Year.
- 346.65 (1) and (2) Penalty for Violating §§346.62 to 346.64.
- 346.66 Applicability of Sections Relating to Accident and Accident Reporting.
- 346.68 and 346.69 Duty upon Striking Unattended Vehicle-upon Striking Property on or Adjacent to Highway-first Offense Within a Year.
- 346.70 (1), (2) or (3), 346.71, 346.72, 346.73 Duty to Report Accident, etc.
- 346.70 (4) Police and Traffic Agencies to Report.
- 346.70 (5) Falsifying Reports-first Offense Within a Year.
- 346.74 (1), (2), (3), (4) Penalties for Failing to Report.
- 346.77 to 346.81 Bicycles and Play Vehicles.
- 346.82 Penalty for Violating §§346.77 to 346.81.
- 346.87 to 346.94 Miscellaneous Rules.
- 346.95 Penalty for Violating §§346.87 to 346.94.
- 347.01 to 347.05 General Provisions.
- 347.06 to 347.29 Lighting Equipment.
- 347.30 Penalty for Violating Lighting Equipment Requirements.
- 347.35 to 347.49 Other Equipment.
- 347.50 Penalty for Violating §§347.35 to 347.49.
- 348.01 to 348.02 Size, Weight, Load-General Provisions.
- 348.05 to 348.10 Size and Load.
- 348.11 Penalty for Violating Size and Load Limitations.
- 348.15 to 348.20 Weight.
- 348.21 Penalty for Violating Weight Limitations.
- 348.25 to 348.27 Permits.
- 348.28 Permits to Be Carried-Penalty.

B. Other Laws Adopted. There are also hereby adopted by reference the following sections of the Wisconsin Statutes. The prosecution of such offense under this Ordinance shall be as provided in Chapters 340 to 348 of the Wisconsin Statutes. The penalty for violation thereof shall be limited to a forfeiture as provided in §7.21 of this Ordinance.

- 287.81 Littering.
- 941.01(1) Negligent operation of vehicle off highway.
- 346.935 Drinking in motor vehicles on highway.

CODE OF GENERAL ORDINANCES, 2021 - KENOSHA, WISCONSIN

C. NonMoving Violations Adopted. There is also hereby adopted by reference the following sections of the Wisconsin Statutes: **346.50 to 346.55 RESTRICTIONS ON STOPPING AND PARKING.**

D. Snowmobiles. Except as otherwise specifically provided in this Ordinance, all provisions of Chapter 350 of the Wisconsin Statutes describing and defining regulations with respect to snowmobiles and their use for which the penalty is a forfeiture only, including penalties to be imposed, are hereby adopted and by reference made a part of this Ordinance as if fully set forth herein. Any act required to be performed or prohibited by any Statute incorporated herein by reference is required or prohibited by this Ordinance.

E. State Motor Vehicle Code Adopted.

1. Except as otherwise provided in this Chapter, the statutory provisions of Sections 110.06 through 110.075, Wisconsin Statutes, and Chapter TRANS 305, Wisconsin Administrative Code, describing and defining regulations with respect to motor vehicle equipment rules, regulations and inspections, are adopted and by reference made a part of this Chapter as if fully set forth herein. Any act required to be performed or prohibited by any statute incorporated herein by reference is required or prohibited by this Section. Any future amendments, revisions or modifications of the statutes incorporated in this Section are intended to be made part of this Section.

2. Any forfeiture for violation of the State Statutes adopted by reference in **Subsection 1.** of this Section shall conform to the forfeiture permitted to be imposed for violation of such statutes, as set forth in the Uniform Deposit and Misdemeanor Bail Schedule of the Wisconsin Judicial Conference, including any variations or increases for subsequent offenses. Such schedule is hereby adopted by reference.

7.02 SPEED LIMITS

State Speed Limits Adopted. The provisions of §§346.57, 346.58 and 346.59 of the Wisconsin Statutes, relating to the maximum and minimum speed of vehicles are hereby adopted as part of this Section as if fully set forth herein.

Pursuant to §349.11(1) of the Wisconsin Statutes, and with the approval of the State Department of Transportation when required, the speed limits shall be as indicated below on the following streets:

- Birch Road from 22nd Avenue to the Sheridan Road Truck Route - 30 MPH.
- Pershing Boulevard from 75th Street to 80th Street - 30 MPH.
- Roosevelt Road from 22nd Avenue to 39th Avenue - 30 MPH.
- Sheridan Road from 85th Street to 7th Avenue, Alford Park Drive - 30 MPH.
- Sheridan Road from 85th Street to 91st Street - 35 MPH.
- Sheridan Road Truck Route from a point 900 feet North of 31st Street to 7th Avenue - Alford Park Drive - 30 MPH.
- Sheridan Road Truck Route from a point 900 feet North of 31st Street to the North City Limits - 35 MPH.
- Washington Road from 16th Avenue to 32nd Avenue - 30 MPH.
- Washington Road from 32nd Avenue to 39th Avenue - 35 MPH.

- 4th Avenue from 50th Street to 51st Place - 15 MPH.
- 7th Avenue from 50th Street to Sheridan Road - Alford Park Drive - 30 MPH.
- 14th Avenue from 57th Street to 59th Street - 15 MPH.
- 14th Place from 22nd Avenue to 30th Avenue - 35 MPH.
- 15th Street from 30th Avenue to 39th Avenue - 30 MPH.
- 18th Street from Birch Road to the 2300 Block - 30 MPH.
- 18th Street from 30th Avenue to 22nd Avenue - 30 MPH.
- 18th Street - 350 feet East of the center of its intersection with 39th Avenue to 350 feet West of the center of its intersection with 39th Avenue - 35 MPH.
- 22nd Avenue from 18th Street to 60th Street and from Roosevelt Road to 88th Street - 30 MPH.

CODE OF GENERAL ORDINANCES, 2021 - KENOSHA, WISCONSIN

- 22nd Avenue from 18th Street to the North City Limits and from 88th Street to the South City Limits - 35 MPH.
- 30th Avenue from 34th Street to 75th Street - 30 MPH.
- 30th Avenue from 34th Street to the North City Limits and from 80th Street to 85th Street - 35 MPH.
- 30th Avenue from 85th Street to 89th Street - 30 MPH.
- 39th Avenue from 15th Street to 18th Street - 35 MPH.
- 39th Avenue from 45th Street to 80th Street and from 15th Street to the North City Limits - 30 MPH.
- 39th Avenue from a point 625 feet North of 27th Street to 45th Street and from 80th Street to the South City Limits - 35 MPH.
- 45th Street from 22nd Avenue to 47th Avenue - 30 MPH.
- 47th Avenue from Washington Road to 52nd Street - 35 MPH.
- 50th Street from 7th Avenue to 4th Avenue - 15 MPH.
- 51st Place from 4th Avenue to end of City jurisdiction - 15 MPH.
- 52nd Street from 6th Avenue to 49th Avenue - 30 MPH.
- 52nd Street from 49th Avenue to Green Bay Road - 35 MPH.
- 60th Avenue from 67th Street to 82nd Street - 30 MPH.
- 60th Street from Sheridan Road to 54th Avenue - 30 MPH.
- 60th Street from 54th Avenue to the West City Limits - 35 MPH.
- 75th Street from Sheridan Road to 44th Avenue - 30 MPH.
- 80th Street from Sheridan Road to the West City Limits - 30 MPH.
- 85th Street from 32nd Avenue to 39th Avenue - 35 MPH.
- 85th Street from Sheridan Road to 32nd Avenue - 30 MPH.
- 91st Street from Sheridan Road to 22nd Avenue - 35 MPH.
- 104th Avenue from 52nd Street to 75th Street - 35 MPH.

7.025 JURISDICTION OVER STREETS

A. Definitions. The following terms, for purposes of this Ordinance, shall mean:

1. Public Street shall mean a street under the jurisdiction of the Common Council, which, unless temporarily closed, or unless vacated or abandoned pursuant to State law, shall be open to the public twenty-four (24) hours a day, seven (7) days a week.

2. Park Street shall mean a street or drive under the jurisdiction of the Park Commission which may be operated, closed or regulated as prescribed thereby.

B. Public Streets shall be such streets as are indicated on the Official City Street Map, which is on file in the Office of the Department of Public Works.

C. Park Streets shall be all streets and drives which run through City Parks, except for the following:

1. Martin Luther King Drive shall be a public street.

2. The streets and drives in Southport Park shall be Park streets. However, the Park Commission shall not close or limit access thereof without the permission of the Water Commission as said streets and drives serve as access to the Wastewater Treatment Facility.

3. Alford Park Drive (State Highway 32) is under the jurisdiction of the State of Wisconsin.

4. Within Simmons Island Park, all streets shall be Park Streets, except for 50th Street to 4th Avenue, 4th Avenue from 50th Street to 51st Place and 51st Place from 4th Avenue to end of cul-de-sac. The Harbor Commission shall have authority to use the street which abuts the Kenosha Small Boat Harbor to the East for the purpose of inserting, removing and temporarily storing boat docks. The Harbor Commission shall have exclusive jurisdiction over the parking areas which abut the Kenosha Small Boat Harbor to the North.

CODE OF GENERAL ORDINANCES, 2021 - KENOSHA, WISCONSIN

D. State Street Aids. Application may be made for State aids relative to streets under the jurisdiction of the Park Commission or Harbor Commission provided that they are opened to the public and signed in the same manner as public streets.

E. Temporary and Emergency Closing of Streets and Drives. Any Public, Park or Harbor street may be closed by any City Police Officer when an emergency makes vehicular or pedestrian traffic thereon unsafe, by any City Firefighter engaged in firefighting activities, by any City Forester engaged in tree cutting or trimming operations, by any Department of Public Works Engineer when streets are being repaired or improved or when sanitary or storm sewer work requires a street opening, or when streets are being cleaned or cleared of snow, by any Water Utility Engineer when water main work requires a street opening, or by anybody having jurisdiction thereof for any lawful City purpose. The Director of Public Works may authorize any person, contractor or Utility to perform any lawful work in any street or drive, upon such person, contractor or Utility executing an Indemnity and Hold Harmless Agreement and upon providing the City with a Certificate of Insurance indicating \$1,000,000 worth of liability and contractual liability insurance, and also naming the City as a named insured under said insurance policy. This provision shall not be construed as authority for the Police Department to close any street for any event or civic function for the purpose of crowd control. Streets may be closed for events or civic functions only by the body having jurisdiction thereof. Whenever a street is closed for an event or civic function, arrangements must be made for vehicular access for emergency vehicles and for the handicapped.

7.03 THROUGH STREETS

All intersections controlled by stop signs shall be declared to be "through streets (highways)" within the meaning of §340.01(67), Wisconsin Statutes.

The following streets in the City of Kenosha, Wisconsin, in the interest of public safety are hereby declared to be through streets:

- Birch Road from C.N.W.R.R. tracks northwest to City Limits.
- Pershing Boulevard from the south City Limits to the north City Limits.
- Roosevelt Road from the south line of 63rd Street west to the west line of 39th Avenue.
- Sheridan Road from the south City Limits to the north City Limits.
- Washington Road from 7th Avenue west to City Limits.
- Wilson Road from 67th Street northwest to its terminus.

- 6th Avenue from the intersection of 7th Avenue to 59th Street.
- 6th Avenue A from 59th Street to 59th Place.
- 7th Avenue from Alford Park Drive to 6th Avenue.
- 7th Avenue from 61st Street south to City Limits.
- 14th Avenue from Washington Road to 22nd Street.
- 14th Avenue from 60th Street to 80th Street.
- 15th Avenue from Birch Road to 15th Street.
- 15th Street from 15th Avenue to 19th Avenue.
- 15th Street from 39th Avenue to 30th Avenue.
- 18th Avenue from 19th Street to 22nd Street, 22nd Street to 24th Street, 24th Street to 27th Street, 27th Street to 31st Street and 31st Street to 35th Street.
- 18th Street from West City Limits to Birch Road.
- 22nd Avenue from the south City Limits north to the north City Limits.
- 24th Street from 14th Avenue west to 30th Avenue except that east-west traffic on 24th Street shall stop for traffic on 22nd Avenue.
- 26th Avenue from 60th Street to 85th Street.
- 27th Street from 14th Avenue to 30th Avenue and 39th Avenue to 47th Avenue.
- 30th Avenue as follows: 30th Avenue from Washington Road to 80th Street.
- 31st Street from Sheridan Road to 18th Avenue, 18th Avenue to 22nd Avenue, and 22nd Avenue to 27th Avenue.
- 35th Street from 22nd Avenue to Sheridan Road.

CODE OF GENERAL ORDINANCES, 2021 - KENOSHA, WISCONSIN

35th Street from 22nd Avenue to 30th Avenue.
38th Street from 22nd Avenue to 18th Avenue and 18th Avenue to 14th Avenue.
39th Avenue from south City Limits to north City Limits.
45th Street from 22nd Avenue west to City Limits.
47th Avenue from 60th Street Northward to the City Limits.
51st Avenue from 67th Street north to City Limits.
52nd Avenue (French Drive) from 67th Street to 75th Street.
52nd Street from 6th Avenue west to the City Limits.
56th Street from 6th Avenue west to 25th Avenue.
57th Street from 22nd Avenue to Sheridan Road.
59th Place from 6th Avenue A to 8th Avenue.
60th Avenue from 60th Street to the South line of 82nd Street.
60th Street from west City Limits to Library Park.
63rd Street from the west line of Sheridan Road to the east line of 30th Avenue.
65th Street from Sheridan Road to 24th Avenue.
67th Street from 18th Avenue to 27th Avenue.
67th Street from 30th Avenue west to City Limits.
75th Street from 1st Avenue to the west City Limits.
80th Street from the west line of Sheridan Road to the west City Limits.
85th Street from Sheridan Road to 39th Avenue.
89th Street from 22nd Avenue to 39th Avenue and from 39th Avenue to 43rd Avenue.
104th Avenue from 52nd Street to 60th Street and from 60th Street to 75th Street.

7.04 PARKING REGULATIONS - HAZARD

1. No operator of any vehicle shall park or stop or leave standing such vehicle on any street or highway or public way in the City of Kenosha, except in obedience to traffic regulations, signs or signals, whether such vehicle is occupied or not, in any of the following places:

- a. In any subway under elevated tracks.
- b. Within 50 feet of the center line of any railroad track at a grade crossing.
- c. On the near side of a street adjacent to and within 25 feet of the main entrance to a church, theater or hospital.
- d. Within 5 feet of a rural mailbox, between the hours of 9:00 A.M. and 4:00 P.M., excluding Sundays and holidays.
- e. In any public alley, except for the purpose and time required to load and unload passengers or materials.
- f. In the arc of a curve where official signs are erected or where there are official yellow paint marks.
- g. In that portion of a street or highway between the curb lines and the adjacent property.

This subsection shall not prohibit adjacent residentially zoned property owners from parking perpendicular to the road on the approachway to their private driveways, provided no portion of any such parked vehicles shall extend to within one (1) foot of any sidewalk or two (2') feet of any curb line.

This Section shall also not prohibit a vehicle used to transport the handicapped which is equipped with a visible wheelchair lift or marked as being equipped with a wheelchair lift and bearing a special registration plate or identification card in accordance with §346.50(2a), 341.14(1a), (1e), (1m), (1q), (1r)(a) or 343.51, Wisconsin Statutes, from parking within two (2') feet of the curb line in that portion of a street or highway between the curb lines and the adjacent property, upon being parallel parked in a lawful manner.

Nothing contained herein shall be interpreted to authorize any motor vehicle to park upon a public sidewalk.

- h. Such other places as are designated by resolution of Council and are officially marked or signed.

CODE OF GENERAL ORDINANCES, 2021 - KENOSHA, WISCONSIN

2. No owner of any vehicle shall suffer or allow or permit such vehicle to be parked or stopped or left standing on any street or highway or public way in the City of Kenosha, except in obedience to traffic regulations or signs or signals, whether such vehicle is occupied or not, in any of the places prohibited by §1.

3. No owner or operator of any vehicle shall park, or stop, or leave standing such vehicle, or suffer, or allow, or permit such vehicle to be parked, or stopped, or left standing on any public street, or highway, or public way in essentially the same place in the City of Kenosha for longer than twenty-four (24) continuous hours.

4. The operator or owner of any truck weighing more than 11,500 pounds, gross vehicle weight, or any truck tractor, motor bus, trailer or semitrailer, shall not park the same on any street or street right-of-way in the City for longer than thirty (30) minutes on any day.

Exception. This Section shall not prohibit any owner or operator of any of the above mentioned vehicles from parking said vehicles for longer than thirty (30) minutes between the hours of 6:00 P.M. and 6:00 A.M. on any street in the City, or any portion thereof, which abuts any business establishment located in a commercial or industrial district of said City.

7.041 PARKING REGULATIONS - UNREGISTERED VEHICLES

A. No owner or operator of any vehicle which has not been properly registered for a period of six (6) months or longer, shall park or leave standing such vehicle, or suffer, allow or permit such vehicle to be parked or left standing on any public street, highway, public way or public place in the City of Kenosha.

B. Any vehicle which has not been properly registered for a period of six (6) months or longer, which is parked or left standing on any public street, highway, public way or public place in the City of Kenosha may be towed and stored by the Police Department, at the cost and expense of the vehicle owner, pursuant to Section 13.12 of the Code of General Ordinances. Unclaimed towed vehicles may be disposed of by towers through means and procedures authorized by law.

7.045 PARKING REGULATIONS - PROSECUTION

A. **Policy.** It is the declared policy of this City that ownership of a vehicle is sufficiently related to causing, allowing, permitting, or suffering a vehicle to be parked so as to require the owner to be responsible for the parking of said vehicle.

B. **Responsibility.** The person or other legal entity to which a vehicle is registered on the date of a parking Ordinance violation shall be a proper party chargeable with said violation.

C. **Presumption.** It shall be presumed, upon a showing by the City, that a parking violation occurred and upon a showing that the party charged pursuant to this Ordinance, was the registered owner of the unlawfully parked vehicle on the date of the violation that said registered owner is responsible for and guilty of the violation charged.

D. **Overcoming Presumption.** The presumption in Subsection C., when established as therein specified, shall constitute a prima facie case and a basis for judgment, except where the person or other legal entity to which the vehicle is registered overcomes said presumption by the submission of proof of any of the following:

1. The vehicle was stolen at the time the violation occurred, and reported as such to law enforcement authorities within a reasonable time thereafter.
2. The vehicle was lawfully parked.
3. The ownership of the vehicle was lawfully transferred to another prior to the violation.

CODE OF GENERAL ORDINANCES, 2021 - KENOSHA, WISCONSIN

E. Limitation. This Ordinance does not prohibit the actual operator of the vehicle responsible for the parking violation to be prosecuted for said violation. However, where the owner is charged, no other charges shall be brought against another, pending the outcome of said action, and the conviction of the owner shall bar further prosecutions for the same offense.

F. Authority. The authority for this Ordinance is founded upon §62.11(5) and §349.13(1), Wisconsin Statutes, and upon such other provisions in law as may be relevant.

7.05 PARKING LIMITS

A. No operator or owner of any motor vehicle shall park, stop, or leave standing, or permit the same to be done on any street or highway for longer than the period of time specified by official City signs.

B. Where no other period of time is specified by Resolution, hourly parking restrictions shall be effective during the hours of 8:00 A.M. to 6:00 P.M., Monday through Saturday, except for the following holidays: New Year's Day, Memorial Day, the Fourth of July, Labor Day, Thanksgiving Day and Christmas Day.

C. During the hours of 7:00 A.M. to 4:30 P.M., during school days, no operator or owner of any motor vehicle shall park, stop or leave standing, any motor vehicle, or permit the same to be done, upon the near side of a street, highway or roadway adjacent to school buildings or adjacent school grounds used for any children below the 9th grade. School buses loading or unloading students shall be exempt from the application of this subsection, as shall be vehicles loading or unloading handicapped children.

D. The City Clerk shall forward a copy of all Resolutions imposing hourly parking restrictions to the Police Department as soon as practicable.

E. No operator or owner of any motor vehicle shall park, stop or leave standing, or permit the same to be done, in any City owned or operated parking lot longer than the period of time specified

7.051 CONTINUOUS PARKING RESTRICTED TIME PARKING ZONES - SEPARATE VIOLATION

Continuous parking beyond posted limits in any posted parking zone which restricts parking to certain minutes or hours is prohibited and each and every violation of said parking restriction shall constitute a separate violation. Continuous parking shall be defined as leaving a vehicle in the same parking space or moving it less than twenty (20') feet away therefrom.

7.06 PARKING RESTRICTIONS

A. No owner or operator of any motor vehicle, motor vehicle trailer, semitrailer or mobile home, except an emergency vehicle engaged in emergency services, shall park, suffer, allow or permit the same to be parked on any street or highway within the City from December First (1st) through March Thirty-first (31st) between the hours of 1:00 A.M. and 6:00 A.M., except as follows:

1. On days bearing an odd calendar date, vehicles may park, unless otherwise prohibited, on that side of the street where buildings bear or would bear an odd numbered address.

2. On days bearing an even calendar date, vehicles may park, unless otherwise prohibited, on that side of a street where buildings bear or would bear an even numbered address.

3. On the following streets:

Lincoln Road - 22nd Avenue to 28th Avenue;
Washington Road - 32nd Avenue to West Limits;

CODE OF GENERAL ORDINANCES, 2021 - KENOSHA, WISCONSIN

7th Avenue - 50th Street to Sheridan Road.
16th Avenue - 71st Street to 73rd Street.
20th Avenue - 76th Street to 80th Street.
25th Avenue - 75th Street to 76th Street.
25th Avenue - 79th Street to 80th Street.
27th Avenue - 76th Street to 79th Street.
31st Avenue - 75th Street to 78th Street.
56th Street - 8th Avenue to 13th Avenue.
68th Place - 3rd Avenue East to Cul-de-sac.
75th Street - 45th Avenue to West Limits.
79th Street - 23rd Avenue to 24th Avenue.

B. 1. The parking prohibitions of subsection 7.06 A. shall not apply to those streets which are limited to parking on one side only.

2. Subsection 7.06 A. shall not apply to those streets that have any parking restrictions between 1:00 A.M. and 8:00 A.M. on one side of the street. On a street that has any parking restrictions between 1:00 A.M. and 8:00 A.M. on one side of the street, no owner or operator of any motor vehicle, motor vehicle trailer, semitrailer or mobile home, except an emergency vehicle engaged in emergency services, may park, suffer, allow or permit the same to be parked on that side of the street having such parking restrictions, from December First (1st) through March Thirty-first (31st) between the hours of 1:00 AM. and 6:00 A.M.

3. In this subsection 7.06 B, "street" means a portion of a highway, as that term is defined in Chapter 346 of the Wisconsin Statutes, bounded by highway intersections at both end of the portion.

4. For the purpose of cleaning or plowing the same, however, the Department of Public Works is hereby authorized and empowered to order vehicles to be removed from the street at particular times provided that signs to that effect are posted on such street to give reasonable notice of such orders.

C. Notice of this Ordinance shall be given by signs as required by §349.13, Wisconsin Statutes.

7.07 PARKING METERS

A. Installation and Use. The Transit Commission is authorized to establish on any street in which parking is by Ordinance or resolution prohibited for more than a limited period of time, parking meter areas and to install in such areas parking meters, including curb or street marking lines, and to have charge of the regulation and operation thereof. The Transit Commission shall maintain such meters in good and workable condition, and collect or cause to be collected monies deposited in the meters by personnel of the City government.

The meters shall be placed upon the curb, next to the individual parking places, and they shall be so constructed as to display a signal showing legal parking upon deposit therein of proper coins, indicated by instructions on the meters.

The charge for parking in parking meter areas shall be as follows: For one or two hour parking zones, one cent for twelve minutes, five cents for one hour and ten cents for two hours.

B. Regulations.

1. Whenever any vehicle shall be parked next to a parking meter, the operator of the vehicle shall park within the area designated by the curb or street marking lines as indicated for parallel or diagonal parking and upon entering the parking space shall immediately deposit in the meter either a one cent coin or a five cent coin. It shall be unlawful for such person to fail or neglect to deposit such coin or to fail to park within the limits designated. Such parking space may then be used by such vehicle during the time limited herein, according to the sum thus deposited, and such vehicle shall be unlawfully parked if it shall

CODE OF GENERAL ORDINANCES, 2021 - KENOSHA, WISCONSIN

remain in such space beyond the period of time for which the operator shall have deposited such coin in the meter.

Where an hourly parking restriction is posted in an area regulated by parking meters, it shall be unlawful to continuously park said vehicle beyond the hourly limitation and the depositing of coins in said meter once the lawful hourly limit is exceeded shall not abate the hourly violation.

2. It shall be unlawful for any person not authorized so to do to tamper with, open, break, injure or destroy any parking meter.

3. It shall be the duty of the Police Department to take the parking meter number and State vehicle number of all vehicles whose operators violate the provisions of **§7.07** and to cause notice thereof to be written in triplicate, leaving one copy thereof with the operator or his vehicle, and another with the Police Department.

C. Parking Lots. Wherever any vehicle shall be parked on an off street parking lot operated by the City, the operator shall park within a space designated for parking and upon entering such space shall immediately deposit in the meter such amount as indicated by the meter for the time he intends to use such space. The deposit shall be made in such coins as indicated by the meter. It shall be unlawful for any person to fail or neglect to deposit such coin or coins. Such parking space may then be used by such vehicle during the time limited as indicated in the meter and according to the sum deposited, and such vehicle shall be unlawfully parked if it shall remain in such space beyond the period of time for which the operator shall have deposited such coin or coins in the meter.

No operator of any vehicle in driving into a stall on any off street parking lot shall do so in any manner except so as to position the front wheels of the vehicle as closely as allowable to the parking meter to be used for the occupancy of the stall.

In parking lots equipped with gates which will open to permit the exit of motor vehicles from the lot only by the insertion of the required coin in a slot provided for that purpose, no operator shall operate his vehicle in physical contact with another vehicle, or in any other manner so as to avoid the payment of the parking fee required.

D. Traffic Violators Permitted to Pay Fine Without Appearing.

1. Any person violating §B.1. or C. above, may pay a penalty of One (\$1.00) Dollar by mailing to, or leaving such amount with the Kenosha Police Department together with a signed stipulation of guilt or No Contest and a waiver of trial, provided the penalty and stipulation are received within 240 hours after the time of delivery of the violation notice by the Police official. The above penalty of One (\$1.00) Dollar shall increase to Ten (\$10.00) Dollars if this paragraph is not complied with. Said penalties shall be transmitted from the Police Department to the Clerk/Treasurer.

2. All persons who wish to deny their guilt and have received notice of their alleged violation of §B.1. and C. above should deliver their violation notice in person to the Kenosha Police Department at the Police Building within 120 hours after the date and hour indicated thereon; arrangement for a court hearing shall be made by such Department.

7.075 PARKING PASSES

A. Purpose. The City of Kenosha, Wisconsin, passes this Ordinance for, but not limited to, the following purposes:

1. To encourage out of City groups to hold conventions and similar gatherings within the City.
2. To make known the hospitality of the City to visitors, creating a feeling of good will, and encouraging the return of the visitor and his or her group to the City.

CODE OF GENERAL ORDINANCES, 2021 - KENOSHA, WISCONSIN

3. To facilitate the visitors access to areas served by parking meters, for the convenience of the visitor, and for the benefit of consumer oriented businesses which will be better able to attract and serve said visitors.

B. Definitions.

1. **Parking Meter Passes** - are printed passes issued by the City Department of Transportation, for a designated period of time, to individual, qualified visitors to the City, for the purpose of entitling said visitors, upon the proper display of said passes, to the parking privilege specified in this Ordinance.

2. **Properly Displayed** - means that the parking pass must be displayed in the inside lower left hand corner of the front windshield.

3. **Qualified Visitors** - entitled to the privileges accruing from the lawful possession and display of the parking passes are those individuals registered in advance with the City Chamber of Commerce as being members of an organized group of twenty-five (25) or more persons, possessing a bona fide common interest, simultaneously visiting the City for the purposes of engaging in the pursuit and development of their bona fide common interest.

C. Privilege. Qualified visitors, lawfully possessing and displaying parking passes, shall be permitted the privilege of parking in a lawful and orderly manner at any City operated parking meter, without the payment of the fee otherwise required by Ordinance and without incurring the issuance of legal process and the imposition of forfeiture or penalty for failure to pay said fee.

D. Form. The parking passes shall be printed at City expense in a form approved by the Director of Transportation and the City Attorney. The passes shall contain the following:

1. Date(s) for which pass is valid.
2. Name and address of qualified visitor to whom the parking pass is issued.
3. Identification of group to which the holder belongs.
4. Statement that a properly displayed parking pass shall be honored only when the displaying vehicle is parked in a lawful and orderly manner at a City operated parking meter, and that the transfer of said parking pass to any other individual would subject the holder to a forfeiture or penalty, as herein specified.

E. Prohibited Uses and Penalty.

1. Residents of the City shall be prohibited from using said parking passes at anytime.
2. The qualified visitor to whom the pass was issued shall be prohibited from transferring the use of the pass to any other individual, at any time under any and all circumstances.
3. Violators of 1. and 2. above shall, upon conviction with the costs of prosecution, and in default of payment of forfeiture and/or costs of prosecution shall be imprisoned in the County Jail until said forfeiture and costs are paid, but not exceeding five (5) days. Each day the violation occurs or continues, shall be treated as a separate offense.

7.08 ANGLE PARKING

A. Four Wheeled Vehicles. The Council, by Resolution, shall designate streets or portions thereof where four wheeled vehicles less than 20 feet in length shall park at a 60° angle. A certified copy of such resolutions shall be on file at all times in the office of the Police Department.

CODE OF GENERAL ORDINANCES, 2021 - KENOSHA, WISCONSIN

B. Vehicles Less Than Four Wheels. Any vehicle with less than four wheels and less than 10 feet in length may park in any street, where parking is permitted, at an angle of 90° to the curb provided the rear wheel or wheels of such vehicle touch the curb.

7.09 TAXI STANDS

The Council by Resolution shall designate portions of streets to be used exclusively for taxicab stands. A certified copy of said resolution and amendments thereof shall be on file at all times in the office of the Police Department.

7.10 ONE WAY STREETS

The following streets are hereby designated as one way traffic streets on which traffic shall move only as follows:

Eastbound only in east and west alley lying one-half (1/2) block north of 60th Street between 30th and 31st Avenues.

Eastbound only on East/West alley North of 80th Street between 28th Avenue and 29th Avenue.

Northbound only in north and south alley in Block 6 Woolacotts Subdivision, from the south line of 61st Street to the north line of 63rd Street.

Northwest bound only on 6th Avenue "A" between 59th Place and 59th Street.

Northbound only on 7th Avenue between 61st Street to 59th Place.

Southbound only on 7th Court between 75th Street and 76th Street.

Southbound only on 8th Avenue between 59th Place and 61st Street.

Northbound only on 10th Avenue between 52nd Street and 65th Street.

Northbound only on 10th Avenue between Washington Road and 40th Street.

Northbound only on 11th Avenue between 38th and 40th Streets.

Southbound only on 11th Avenue between 52nd Street and 65th Street.

Northbound only on 13th Avenue between 60th Street and 65th Street.

Northbound only on 13th Court between 58th Street and 67th Street.

Southbound traffic only on 15th Avenue between 65th Street and 68th Street.

Northbound traffic only on 16th Avenue between 65th Street and 68th Street.

Northbound only on 18th Avenue from 41st Place to 41st Street.

Northbound only on 21st Avenue between 57th Street and 60th Street.

Southbound only on 25th Avenue between 56th Street and 57th Street.

Northbound only on 26th Avenue between 53rd Street and 52nd Street.

Northbound only on 37th Avenue between 75th Street and Roosevelt Road.

Southbound only on 38th Avenue from Roosevelt Road to 75th Street.

Southbound traffic only on 40th Avenue between 75th Street and 73rd Street.

Westbound only on 41st Street from 18th Avenue to first alley East of 21st Avenue.

Westbound only on 45th Street from a point approximately 240 feet east of 5th Avenue to 5th Avenue.

Eastbound only on 57th Street between 25th Avenue and 24th Avenue.

Eastbound only on 58th Street between 14th Avenue and 13th Court.

Westbound only on 58th Street between 11th Avenue and 13th Avenue.

Westbound only on 59th Place between 7th Avenue and 8th Avenue.

Eastbound only on 61st Street between 8th Avenue and 7th Avenue.

Eastbound only on 61st Street from 14th Avenue to 22nd Avenue.

Westbound only on 62nd Street from 14th Avenue to 22nd Avenue.

Eastbound only on 63rd Place between 20th Avenue and 22nd Avenue.

Eastbound only on 64th Street between 12th and 8th Avenues.

Westbound only on 76th Street between 34th Avenue and 36th Avenue.

Eastbound only on 77th Street between 36th Avenue and 34th Avenue.

CODE OF GENERAL ORDINANCES, 2021 - KENOSHA, WISCONSIN

7.11 LOADING ZONES

Definition. A **loading zone** is that portion of the street frontage, as designated by the Common Council, to be used for the loading or unloading of people or goods and shall not be used for any other type of parking.

Every occupant of any premises served by a loading zone shall pay for the privilege of such loading zone an annual fee. The annual fee per linear foot of the length of the loading zone is as follows:

In Districts Zoned B-3:

For Monday through Sunday, 24 Hours per Day, Holidays Included. \$25.00

For All Zoning Districts Other Than B-3:

For Monday through Friday, 8:00 A.M.-5:00 P.M. Each Day, Statutory Holidays Excepted. \$25.00

For Monday through Friday, 7:00 A.M.-7:00 P.m., and Saturdays, 8:00 A.M.-12:00 Noon, Statutory Holidays Excepted. \$25.00

For Monday through Sunday, 24 Hours Per Day, Holidays Included..... \$50.00

The fee shall be paid in advance to the Clerk/Treasurer on or before the 2nd day of January of each year. If the fee is not paid by January 31, the Resolution creating such zone shall be automatically repealed and revoked, and the Clerk/Treasurer shall report the same to the Traffic Engineer who shall remove all signs indicating such zone.

Every applicant for a loading zone shall deposit with the Clerk/Treasurer a sum equal to the annual fee for every foot of loading zone requested. The Clerk/Treasurer shall not present the request for such zone to the Council unless such deposit be made. If the Council refuses to grant such zone, the deposit shall be returned at the rate per foot for every foot not granted. If the loading zone is granted, or any part thereof, the amount of deposit retained shall serve as a fee for the balance of the year.

During the first year said loading zone becomes effective, the fee shall be prorated as follows: The full annual fee if the loading zone becomes effective during the first three months of the year; three-fourths of the annual fee if the loading zone becomes effective during the second three months of the year; one-half of the annual fee if the loading zone becomes effective during the third three months of the year; and, one-fourth of the annual fee if the loading zone becomes effective during the last three months of the calendar year.

It shall be required that a loading zone shall be not less than twenty feet (20') in length, except where angle parking is permitted, or in certain locations that might require special consideration.

The City Police Department may, upon the complaint of any person or party granted a loading zone privilege, tow away any vehicle unlawfully parked within a loading zone. The owner of said unlawfully parked vehicle shall be responsible for the expense of towing and storing said towed vehicle and the tower need not release said vehicle until all such costs are paid. No vehicle may be towed from a loading zone unless a citation for unlawful parking within a loading zone is first issued and unless the loading zone is posted both as a loading zone and as a towaway zone.

7.115 SIGNALIZED INTERSECTIONS

A. Listing. The following intersections shall be controlled by automatic traffic control signals:

Roosevelt Road and 22nd Avenue.

Roosevelt Road and 26th Avenue.

Roosevelt Road and 30th Avenue.

Sheridan Road and 80th Street.

CODE OF GENERAL ORDINANCES, 2021 - KENOSHA, WISCONSIN

STH 32 and 7th Avenue.
STH 32 and Carthage Drive.
Washington Road and 22nd Avenue.
Washington Road and 30th Avenue.
Washington Road and 39th Avenue.
Washington Road and Sheridan Road.

15th Street and 30th Avenue.
18th Street and 30th Avenue.
22nd Avenue and 18th Street.
22nd Avenue and 35th Street.
22nd Avenue, Birch Road and 14th Place.
26th Avenue and 85th Street.
27th Street and 22nd Avenue.
27th Street and 30th Avenue.
30th Avenue and 35th Street.
39th Avenue and 45th Street.
45th Street and 22nd Avenue.
45th Street and 30th Avenue.
50th Street and 7th Avenue.
50th Street and 22nd Avenue.
50th Street and Sheridan Road.
52nd Street and 22nd Avenue.
52nd Street and 30th Avenue.
52nd Street and 35th Avenue.
52nd Street and 39th Avenue.
52nd Street and 42nd Avenue.
52nd Street and 43rd Avenue.
52nd Street and Pershing Boulevard.
52nd Street and Sheridan Road.
5300 - 52nd Street.
54th Street and Sheridan Road.
56th Street and 22nd Avenue.
56th Street and Sheridan Road.
58th Street and Sheridan Road.
60th Street and 22nd Avenue.
60th Street and 24th Avenue.
60th Street and 30th Avenue.
60th Street and 39th Avenue.
60th Street and Pershing Boulevard.
60th Street and Sheridan Road.
63rd Street and 22nd Avenue.
63rd Street and Sheridan Road.
75th Street and 22nd Avenue.
75th Street and 26th Avenue.
75th Street and 30th Avenue.
75th Street, 39th Avenue and Roosevelt Road.
75th Street and Pershing Boulevard.
75th Street and Sheridan Road.
80th Street and 22nd Avenue.
80th Street and 28th Avenue.
80th Street and 30th Avenue.
80th Street and 35th Avenue.
80th Street and 39th Avenue.
80th Street and Pershing Boulevard.
85th Street and 22nd Avenue

CODE OF GENERAL ORDINANCES, 2021 - KENOSHA, WISCONSIN

85th Street and 30th Avenue.
85th Street and 39th Avenue.
85th Street and Sheridan Road.
89th Street and 39th Avenue.
91st Street and Sheridan Road.

B. Purpose. This Section is intended to list the existing signalized intersections within the City and does not specify the timing, phasing or other operation of said signalized intersections and does not govern the effective date of the operation of said traffic signals.

7.116 RIGHT TURN ON RED

A. Right Turn on Red When Children Not Present. Right turns on red shall be permitted at all intersections within the City controlled by automatic turn signals, except for the following intersections at which right turns shall be permitted on red only when children are not present:

Roosevelt Road and 26th Avenue.
Roosevelt Road and 30th Avenue.
Washington Road and Sheridan Road

45th Street and 22nd Avenue.
45th Street and 39th Avenue - Northbound and Eastbound traffic only.
60th Street and 22nd Avenue - Southbound and Eastbound traffic only.
75th Street and 22nd Avenue.
80th Street and 22nd Avenue - Westbound and Northbound traffic only.
85th Street and 22nd Avenue.
85th Street Westbound only and 26th Avenue.

B. No Turn on Red at Any Time. Right turns on red are expressly prohibited at the following intersections at any time:

63rd Street and 22nd Avenue.
75th Street, 39th Avenue and Roosevelt Road.
Eastbound 75th Street at Pershing Boulevard and Plaza Exit.
Eastbound traffic on Washington Road at Sheridan Road.
Northbound Pershing Plaza Exit at 75th Street.
Northbound traffic on 22nd Avenue at Roosevelt Road.
Westbound 57th Street at Sheridan Road.

Miscellaneous. A right turn on red must be made in accordance with State law. Children shall be deemed to be present when one or more child under the age of 18 is within the intersection whether or not within the crosswalk, or within 100 feet of the intersection, but within the street right-of-way area, including the sidewalk and lawn park areas.

7.12 STOP STREETS

A. All vehicles shall stop on: 13th Avenue before entering or crossing any street leading into the subway under the tracks for the Chicago and Northwestern Railroad.

B. All vehicles shall stop before entering the intersections of:

Harrison Road and 45th Avenue
Pershing Boulevard and 67th Street
Pershing Boulevard and Wilson Road
Roosevelt Road and 47th Avenue

CODE OF GENERAL ORDINANCES, 2021 - KENOSHA, WISCONSIN

1st Avenue and 54th Street
3rd Avenue and 56th Street
5th Avenue and 57th Street
5th Avenue and 60th Street
6th Avenue and 52nd Street
6th Avenue [A] and 59th Street
7th Avenue and 49th Street
7th Avenue and 59th Street
7th Avenue and 61st Street
7th Avenue and 75th Street
7th Avenue and Washington Road
8th Avenue and 50th Street
10th Avenue and 57th Street
10th Avenue and 58th Street

14th Avenue and 27th Street
14th Avenue and 35th Street
15th Avenue, 18th Street and Birch Road
15th Street and 16th Avenue
15th Street and 39th Avenue
16th Avenue and 71st Street
16th Avenue and 73rd Street
17th Avenue and 79th Street
17th Avenue and 81st Street
18th Avenue and 24th Street
18th Avenue and 35th Street
18th Avenue and 67th Street
19th Avenue and 19th Street
19th Street and 18th Avenue
19th Avenue and 51st Street
19th Avenue and 78th Street

20th Avenue and 79th Street
21st Avenue and 79th Street
22nd Street and 18th Avenue
23rd Avenue and 51st Street
24th Street and 25th Avenue
24th Street and 48th Avenue
24th Avenue and 63rd Street
25th Avenue and 64th Street
26th Avenue and 73rd Street
27th Avenue and 69th Street
27th Avenue and 71st Street
27th Street and 26th Avenue
27th Street and 47th Avenue

30th Street and 19th Avenue
30th Street and 21st Avenue
31st Street and 14th Avenue
31st Street and 18th Avenue
32nd Avenue and 67th Street
32nd Avenue and 41st Street
32nd Avenue and 87th Place
35th Street and 17th Avenue
35th Street and 18th Avenue
36th Avenue and 76th Street
36th Avenue and 77th Street
37th Avenue and 77th Street

CODE OF GENERAL ORDINANCES, 2021 - KENOSHA, WISCONSIN

37th Avenue and 78th Street
38th Street and 18th Avenue
38th Avenue and 68th Street
39th Avenue and 13th Place
39th Avenue and 18th Street

40th Avenue and 57th Street
43rd Avenue and 57th Street
45th Street and 5th Avenue
45th Street and 30th Avenue
45th Street and 47th Avenue
45th Avenue and 67th Street
47th Avenue and 67th Street
48th Street and 19th Avenue
49th Street and 8th Avenue

50th Street and 19th Avenue
50th Street and 38th Avenue
51st Street and 20th Avenue
52nd Avenue and 55th Street
51st Street and 18th Avenue
53rd Street and 10th Avenue
54th Avenue and 63rd Street
54th Street and 4th Avenue
54th Street and 6th Avenue
54th Street and 14th Avenue
54th Street and 19th Avenue
55th Avenue and 41st Street
55th Street and 6th Avenue
55th Street and 8th Avenue
56th Street and 5th Avenue
56th Street and 6th Avenue
56th Street and 7th Avenue
56th Street and 8th Avenue
56th Street and 19th Avenue
56th Street and 31st Avenue
56th Street and 56th Avenue
56th Street and Pershing Boulevard
57th Street and 6th Avenue
57th Street and 16th Avenue
57th Street and 19th Avenue
58th Street and 6th Avenue
58th Street and 7th Avenue
58th Street and 8th Avenue
58th Street and 47th Avenue
58th Street, 49th Avenue and 50th Avenue
58th Street and 52nd Avenue
58th Street and 59th Street

60th Avenue and 69th Street
60th Avenue and 80th Street
60th Avenue and 82nd Street
61st Street and 46th Avenue
61st Street and 111th Avenue
62nd Street and 111th Avenue
63rd Street and 23rd Avenue
63rd Street and 25th Avenue
63rd Street and 37th Avenue

CODE OF GENERAL ORDINANCES, 2021 - KENOSHA, WISCONSIN

63rd Street and 49th Avenue
64th Street and 26th Avenue
64th Street and 99th Avenue

64th Street and 111th Avenue
65th Street and 8th Avenue
65th Street and 14th Avenue
65th Street and 18th Avenue
65th Street and 51st Avenue
65th Street and 54th Avenue
65th Street and 60th Avenue
67th Street and 57th Avenue
67th Street and 60th Avenue
67th Street and 96th Avenue
68th Street and 5th Avenue
68th Street and 14th Avenue
68th Place & 111th Avenue
69th Street and 47th Avenue
69th Street and 107th Avenue
69th Street & 111th Court

70th Street and 96th Avenue
71st Street and 122nd Avenue
76th Street and 14th Avenue
76th Street and 28th Avenue
77th Street and 34th Avenue
78th Street and 14th Avenue
78th Street and 20th Avenue
78th Street and 36th Avenue
79th Street and 36th Avenue

82nd Street and 63rd Avenue
83rd Street and 17th Avenue
85th Street and 30th Avenue
87th Street and 17th Avenue
89th Street and 30th Avenue
89th Street and 32nd Avenue
89th Street and 43rd Avenue
94th Avenue and 73rd Street

C. All vehicles traveling on the following streets shall stop before crossing the following streets:

All vehicles traveling on 13th Court shall stop before entering the intersection of 43rd Street.

Northbound vehicles traveling on 27th Avenue shall stop before entering or crossing 67th Street.

Vehicles traveling North and South on 21st Avenue shall stop before entering the intersection with 19th Street.

Vehicles traveling eastward on 53rd Street shall stop before entering the intersection with 52nd Avenue.

Vehicles traveling East and West on 21st Street shall stop before entering the intersection with 16th Avenue.

Vehicles traveling West on 84th Street shall stop before entering the intersection with 17th Avenue.

Vehicles traveling on 25th Avenue shall stop before entering the intersection of 27th Street.

Vehicles traveling north on 8th Avenue shall stop before entering the intersection at 61st Street.

Vehicles traveling east on 69th Street shall stop before entering the intersection with 45th Avenue.

Vehicles traveling west on 68th Place shall stop before entering the intersection with 45th Avenue

All vehicles traveling on 14th Avenue shall stop before entering or crossing 57th Street.

All vehicles traveling on 24th Avenue shall stop before entering the intersection or 69th Street.

CODE OF GENERAL ORDINANCES, 2021 - KENOSHA, WISCONSIN

All vehicles traveling on 43rd Street shall stop before entering the intersection of 5th Avenue.
Vehicles traveling on 21st Avenue shall stop before entering the intersection of 43rd Street and 45th Street.
Vehicles traveling west on 68th Street and east and west on 69th Street shall stop before entering 18th Avenue.
Vehicles traveling on 11th Avenue shall stop before entering 57th Street.
All vehicles traveling on 46th Avenue shall stop before entering the intersection with 56th Street.
All vehicles traveling southbound on 24th Avenue shall stop before entering the intersection with 64th Street.
All vehicles traveling on 61st Street shall stop before entering the intersection with 23rd Avenue.
All vehicles traveling on 16th Avenue shall stop before entering the intersection of 57th Street.
Vehicles traveling on 23rd Avenue shall stop before entering the intersection of 73rd Street.
Vehicles traveling 62nd Street shall stop before entering or crossing 20th Avenue.
Vehicles traveling 60th Street shall stop before entering or crossing 5th Avenue.
Vehicles traveling 61st Street shall stop before entering or crossing 20th Avenue.
Vehicles traveling on 64th Street between 7th and 8th Avenues shall stop before entering either 7th or 8th Avenues.
Vehicles traveling on 15th Avenue shall stop before entering 62nd Street.
Vehicles traveling on 59th Street shall stop before entering 5th Avenue.
Vehicles traveling on 57th Street shall stop before entering the intersection at 24th Avenue.
Until 80th Street at 38th Avenue is opened to traffic, all vehicles traveling on 38th Avenue shall stop before entering the intersection at 79th Street.
Vehicles traveling on 57th Street shall stop before entering the intersection at 8th Avenue.
All vehicles traveling on 21st Street shall stop before entering the intersection with 19th Avenue.
Vehicles traveling east on 60th Place shall stop before entering the intersection at 20th Avenue.
All vehicles traveling East on Roosevelt Road shall stop before entering the intersection with 47th Avenue and, vehicles traveling North and South on 47th Avenue shall stop before entering the intersection with Roosevelt Road.
Vehicles traveling on 28th Avenue shall stop before entering the intersection with 73rd Street.
All vehicles traveling on 46th Street shall stop before entering the intersection with 32nd Avenue.
All vehicles traveling on 48th Street shall stop before entering the intersection with 33rd Avenue.
Vehicles traveling on 38th Avenue shall stop before entering the intersection at 73rd Street.
All vehicles traveling south on 8th Avenue shall stop before entering the intersection at 58th Street.
All vehicles traveling north on 7th Avenue shall stop before entering the intersection at 58th Street.
Vehicles traveling east or west on 58th Street shall stop before entering the intersection with Pershing Boulevard.
Vehicles traveling on 18th Avenue shall stop before entering the intersection at 57th Street.
All vehicles traveling on 29th Avenue shall stop before entering the intersection with 64th Street.
All vehicles traveling East on 42nd Street shall stop before entering the intersection with 45th Avenue.
All vehicles traveling on 27th Avenue shall stop before entering the intersection with 64th Street.
All vehicles traveling on 23rd Avenue shall stop before entering the intersection with 29th Street.
All vehicles traveling on 8th Avenue shall stop before entering the intersection with 47th Street.
All vehicles traveling West on 59th Place shall stop before entering the intersection with 8th Avenue.
All vehicles traveling South on 23rd Avenue shall stop before entering the intersection with 76th Street.
All vehicles traveling on 59th Avenue shall stop before entering the intersection with 63rd Street.
Vehicles traveling on 61st Street shall stop before entering the intersection at 24th Avenue.
Vehicles traveling on 27th Avenue shall stop before entering the intersection of 73rd Street.
Vehicles traveling on 7th Avenue shall stop before entering or crossing 55th Street.
Vehicles traveling on 23rd Avenue shall stop before entering or crossing 71st Street.
All vehicles traveling west on 60th Street shall stop before entering 7th Avenue.
Vehicles traveling on 28th Avenue shall stop before entering or crossing the intersection at 64th Street.
All vehicles traveling on 76th Street shall stop before entering the intersection at 26th Avenue.
All vehicles traveling on 78th Street shall stop before entering the intersection at 18th Avenue.
All vehicles traveling on 58th Street shall stop before entering the intersection with 32nd Avenue.
All vehicles traveling on 79th Street shall stop before entering the intersection with 32nd Avenue.

CODE OF GENERAL ORDINANCES, 2021 - KENOSHA, WISCONSIN

All vehicles traveling on 28th Street shall stop before entering the intersection with 18th Avenue.
All vehicles traveling Westward on 88th Street shall stop before entering the intersection with 42nd Avenue.
All vehicles traveling Northward on 42nd Avenue shall stop before entering the intersection with 87th Street.
All vehicles traveling Westward on Madison Road shall stop before entering the intersection with 19th Avenue.
All vehicles traveling on 42nd Avenue shall stop before entering the intersection with 50th Street.
All vehicles traveling on 43rd Avenue shall stop before entering the intersection with 50th Street.
All vehicles traveling on 18th Avenue shall stop before entering the intersection with 27th Street.
All vehicles traveling on 44th Court shall stop before entering the intersection with 50th Street.
Vehicles traveling on 26th Avenue shall stop before entering the intersection with 80th Street, Lincoln Road, and 85th Street.
Vehicles traveling west on 58th Street shall stop before entering or crossing 13th Avenue.
Vehicles traveling on 17th and 19th Avenues shall stop before entering the intersection with 22nd Street.
Eastbound vehicles on 22nd Street shall stop before entering the intersection at 14th Avenue.
Southbound vehicles on 14th Avenue shall stop before entering the intersection at 22nd Street.
Northbound vehicles on 14th Avenue shall stop before entering the intersection at 22nd Street except for such vehicles as turn right over the railroad tracks.
Vehicles traveling on 16th Avenue shall stop before entering the intersection at 40th Street.
Vehicles traveling on 23rd Avenue shall stop before entering the intersection at 79th Street.
Southbound vehicles traveling on 11th Avenue shall stop before entering or crossing 43rd Street.
Vehicles traveling on 38th Avenue shall stop before entering the intersection with 77th Street.
Vehicles traveling east on 63rd Street shall stop before entering the intersection with 49th Avenue.
Vehicles traveling east on 61st Street shall stop before entering the intersection with 49th Avenue.
Vehicles traveling north on 49th Avenue, 48th Avenue, 47th Avenue and 46th Avenue shall stop before entering the intersection with 63rd Street.
Vehicles traveling south on 49th Avenue, 48th Avenue, 47th Avenue and 46th Avenue shall stop before entering the intersection with 61st Street.
Vehicles traveling west on 63rd Street shall stop before entering the intersection with 46th Avenue.
All vehicles traveling north and south on 29th Avenue shall stop before entering the intersection with 66th Street.
All vehicles traveling east and west on 79th Street shall stop before entering the intersection with 28th Avenue.
All vehicles traveling on 21st Street shall stop before entering the intersection with 18th Avenue.
All vehicles traveling on 14th Avenue shall stop before entering the intersection with 83rd Street.
Vehicles traveling north and south on 25th Avenue shall stop before entering the intersection with Lincoln Road.
Vehicles traveling north and south on 43rd Avenue shall stop before entering the intersection with 79th Street.
All vehicles traveling in a westerly direction of Buchanan Road shall stop before entering the intersection with 28th Avenue.
All vehicles traveling Westward on 58th Street shall stop before entering the intersection with 11th Avenue.
All vehicles traveling on 35th Avenue shall stop before entering the intersection with 48th Street.
All vehicles traveling East or West on 19th Street shall stop before entering the intersection with 16th Avenue.
All vehicles traveling on 5th Avenue shall stop before entering the intersection with 61st Street.
All vehicles traveling on 50th Street shall stop before entering the intersection with 33rd Avenue.
All vehicles traveling north on 21st Avenue shall stop before entering the intersection with 35th Place.
All vehicles traveling on 5th Avenue shall stop before entering the intersection with 65th Street.
All vehicles traveling southbound on 47th Avenue shall stop before entering the intersection with Harrison Road.
All vehicles traveling north and south on 21st Avenue shall stop before entering the intersection with 48th Street.

CODE OF GENERAL ORDINANCES, 2021 - KENOSHA, WISCONSIN

All vehicles traveling on 23rd Avenue shall stop before entering the intersection with 26th Street.
All vehicles traveling northbound on 17th Avenue shall stop before entering the intersection with 84th Street.
All vehicles traveling on 31st Avenue shall stop before entering the intersection with 79th Street.
All vehicles traveling southbound on 42nd Avenue shall stop before entering the intersection with 89th Street.
All vehicles traveling on 33rd Avenue shall stop before entering the intersection with 55th Street.
All vehicles traveling on 61st Street shall stop before entering the intersection of 54th Avenue.
All vehicles traveling Northward on 10th Avenue shall stop before entering the Intersection with 58th Street.
Vehicles traveling North and South on 20th Avenue shall stop before entering the intersection with 67th Street.
Vehicles traveling east and west on 44th Street be required to stop before entering the intersection with 5th Avenue.
All vehicles traveling on 15th Avenue shall stop before entering the intersection with 83rd Street.
All vehicles traveling on 58th Street shall stop before entering the intersection with 31st Avenue.
Vehicles traveling East and West on 46th Street shall stop before entering the intersection with 8th Avenue.
Vehicles traveling North and South on 50th Avenue shall stop before entering the intersection with 65th Street.
Vehicles traveling East and West on 65th Street shall stop before entering the intersection with 49th Avenue.
All vehicles traveling North or South on 32nd Avenue shall stop before entering the intersection with 89th Street.
All vehicles traveling East and West on 73rd Street shall stop before entering the intersection with 40th Avenue.
All vehicles traveling West on 86th Place shall stop before entering the intersection with 36th Avenue.
All vehicles traveling North on 34th Avenue shall stop before entering the intersection with 86th Place.
Vehicles traveling on 38th Avenue shall stop at 76th Street.
Vehicles traveling on 76th Street shall stop at 37th Avenue.
All vehicles approaching Newman Park shall stop before entering intersection with streets surrounding said park.
All vehicles traveling on 36th Avenue shall stop at 79th Street.
Vehicles traveling south on 14th Avenue shall stop before entering the intersection with 84th Street and 15th Avenue.
All vehicles traveling East and West on 48th Street shall stop before entering the intersection with 36th Avenue.
Vehicles traveling East or West on 61st, 65th, 69th and 73rd Streets shall stop before entering the intersection with 3rd Avenue.
All vehicles traveling North and South on 17th Avenue shall stop before entering the intersection with 19th Street.
All vehicles traveling North and South on 31st Avenue shall stop before entering the intersection with 40th Street.
All vehicles traveling on 21st Avenue shall stop before entering the intersection with 53rd Street.
All vehicles traveling on 63rd Street shall stop before entering the intersection, with 50th Avenue.
All vehicles traveling on 82nd Street shall stop before entering the intersection with 25th Avenue.
All vehicles traveling on 76th Street shall stop before entering the intersection with 28th Avenue.
All vehicles traveling west on 58th Street shall stop before entering the intersection with 56th Avenue.
All vehicles traveling on 10th Avenue shall stop before entering the intersection with 40th Street.
All vehicles traveling on 25th Avenue shall stop before entering the intersection with 79th Street.
All vehicles traveling on 79th Street shall stop before entering the intersection with 24th Avenue.
All vehicles traveling on 51st Avenue shall stop before entering the intersection with 55th Street.
All vehicles traveling on 55th Street shall stop before entering the intersection with 49th Avenue.
All vehicles traveling on 51st Street shall stop before entering the intersection with 29th Avenue.

CODE OF GENERAL ORDINANCES, 2021 - KENOSHA, WISCONSIN

All vehicles traveling on 53rd Street shall stop before entering the intersection with 32nd Avenue.
All vehicles traveling east on 87th Place shall stop before entering the intersection with 43rd Avenue.
All vehicles traveling on 46th Avenue shall stop before entering the intersection with 87th Place.
All vehicles traveling on 88th Place shall stop before entering the intersection with 43rd Avenue.
All vehicles traveling on 33rd Avenue shall stop before entering the intersection with 79th Street.
All vehicles traveling on 31st Avenue shall stop before entering the intersection with 73rd Street.
All vehicles traveling on 59th Street shall stop before entering the intersection with 42nd Avenue.
All vehicles traveling Eastbound on 45th Street shall stop before entering the intersection with 17th Avenue.
All vehicles traveling on 31st Avenue shall stop before entering the intersection with 61st Street.
All vehicles traveling on 40th Avenue shall stop before entering the intersection with 76th Street.
All vehicles traveling on 70th Street shall stop before entering the intersection with 55th Avenue.
All vehicles traveling on 70th Street shall stop before entering the intersection with 57th Avenue.
All vehicles traveling on 53rd Street shall stop before entering the intersection with 11th Avenue.
All vehicles traveling on 78th Street shall stop before entering the intersection with 33rd Avenue.
All vehicles traveling on 28th Avenue shall stop before entering the intersection with 78th Street.
All vehicles traveling on 34th Avenue shall stop before entering the intersection with 73rd Street.
All vehicles traveling on 71st Street shall stop before entering the intersection with 5th Avenue.
All vehicles traveling on 44th Place shall stop before entering the intersection with 21st Avenue.
All vehicles traveling on 50th Avenue shall stop before entering the intersection with 61st Street.
All vehicles traveling on 73rd Street shall stop before entering the intersection with 41st Avenue.
All vehicles traveling Northbound on 10th Avenue shall stop before entering the intersection with 54th Street.
All vehicles traveling on 55th Street shall stop before entering the intersection with 23rd Avenue.
All vehicles traveling Southbound on 11th Avenue shall stop before entering the intersection with 54th Street.
All vehicles traveling Eastbound on 55th Street shall stop before entering the intersection with 11th Avenue.
All vehicles traveling on 4th Avenue shall stop before entering the intersection with 58th Street.
All vehicles traveling Southbound on 34th Avenue shall stop before entering the intersection with 80th Street.
All vehicles traveling on 44th Street shall stop before entering the intersection with Kennedy Drive.
All vehicles traveling on Johnson Road shall stop before entering the intersection with 24th Avenue.
All vehicles traveling on 34th Avenue shall stop before entering the intersection with 79th Street.
All vehicles traveling on 53rd Street shall stop before entering the intersection with 24th Avenue.
All vehicles traveling on 53rd Street shall stop before entering the intersection with 23rd Avenue.
All vehicles traveling North and South on 23rd Avenue shall stop before entering the intersection with 54th Street.
All vehicles traveling North and South on 25th Avenue shall stop before entering the intersection with 54th Street.
All vehicles traveling on 24th Avenue shall stop before entering the intersection with 54th Street.
All vehicles traveling on 14th Avenue shall stop before entering or crossing 31st Street.
All vehicles traveling North and South on 27th Avenue shall stop before entering the intersection with 76th Street.
All vehicles traveling eastbound on 70th Street shall stop before entering the intersection with 34th Avenue.
All vehicles traveling on 34th Avenue shall stop before entering the intersection with 78th Street.
All vehicles traveling on 57th Street shall stop before entering the intersection of 23rd Avenue.
All vehicles traveling Southbound on 17th Avenue shall stop before entering the intersection with 84th Street.
All vehicles traveling on 42nd Avenue shall stop before entering the intersection with 78th Street.
All vehicles traveling on 37th Avenue shall stop before entering the intersection with 68th Street.
All vehicles traveling Eastbound on 40th Street shall stop before entering the intersection with 13th Avenue.
All vehicles traveling on 17th Avenue shall stop before entering the intersection with 78th Street.
All vehicles traveling Westbound on 76th Street shall stop before entering the intersection with 10th Avenue.

CODE OF GENERAL ORDINANCES, 2021 - KENOSHA, WISCONSIN

All vehicles traveling on 6th Avenue shall stop before entering the intersection with 68th Street.
All vehicles traveling on 20th Avenue shall stop before entering the intersection with 48th Street.
All vehicles traveling on 32nd Street shall stop before entering the intersection with 21st Avenue.
All vehicles traveling on 32nd Street shall stop before entering the intersection with 19th Avenue.
All vehicles traveling on 57th Avenue shall stop before entering the intersection of 63rd Street.
All vehicles traveling on 10th Avenue shall stop before entering the intersection of 45th Street.
All vehicles traveling on 32nd Avenue shall stop before entering the intersection with 73rd Street.
All vehicles traveling on 38th Avenue shall stop before entering the intersection of 59th Street.
All vehicles traveling on 49th Avenue shall stop before entering the intersection of 69th Street.
All vehicles traveling on 55th Street shall stop before entering the intersection with 35th Avenue.
All vehicles traveling on 31st Avenue shall stop before entering the intersection of 58th Street.
All vehicles traveling on 23rd Street shall stop before entering the intersection of 19th Avenue.
All vehicles traveling Westbound on 54th Street shall stop before entering the intersection of 64th Avenue.
All vehicles traveling on 78th Street shall stop before entering the intersection with 31st Avenue.
All vehicles traveling on 21st Avenue shall stop before entering the intersection of 29th Street.
All vehicles traveling on 56th Street shall stop before entering the intersection with 42nd Avenue.
All vehicles traveling on 58th Street shall stop before entering the intersection with 33rd Avenue.
All vehicles traveling Westbound on 82nd Place shall stop before entering the intersection with 60th Avenue.
All vehicles traveling Eastbound on 82nd Place shall stop before entering the intersection with 57th Avenue.
All vehicles traveling on 58th Street shall stop before entering the intersection with 3rd Avenue.
All vehicles traveling on 53rd Street shall stop before entering the intersection with 44th Avenue.
All vehicles traveling on 45th Avenue shall stop before entering the intersection with 79th Street.
All vehicles traveling on 46th Avenue shall stop before entering the intersection with 79th Street.
All vehicles traveling east on Roosevelt Road shall stop before entering the intersection with 47th Avenue, and all vehicles traveling north and south on 47th Avenue shall stop before entering the intersection with Roosevelt Road.
All vehicles traveling on Adams Road shall stop before entering the intersection with 55th Avenue.
All vehicles traveling on 51st Street shall stop before entering the intersection with 33rd Avenue.
All vehicles traveling on 3rd Avenue shall stop before entering the intersection with 71st and northbound stop only at 60th Street.
All vehicles traveling on 68th Street shall stop before entering the intersection with 3rd Avenue.
All vehicles traveling on 57th Street shall stop before entering the intersection of 49th Avenue.
All vehicles traveling on 53rd Street shall stop before entering the intersection with 17th Avenue.
All vehicles traveling on 44th Avenue shall stop before entering the intersection with 58th Street.
All vehicles traveling on 46th Avenue shall stop before entering the intersection with 50th Street.
All vehicles traveling on 57th Street shall stop before entering the intersection with 42nd Avenue.
All vehicles traveling on 53rd Street shall stop before entering the intersection with 14th Avenue.
All vehicles traveling on 24th Avenue shall stop before entering the intersection with 73rd Street.
All vehicles traveling on 53rd Street shall stop before entering the intersection with Pershing Boulevard.
All vehicles traveling on 72nd Street shall stop before entering the intersection with 94th Avenue.
All vehicles traveling on 61st Street shall stop before entering the intersection with 49th Avenue.
All vehicles traveling on 63rd Street shall stop before entering the intersection with 46th Avenue.
All vehicles traveling eastbound on 59th Place and southbound from dead end shall stop before entering the intersection with 3rd Avenue.
All vehicles traveling on 14th Avenue shall stop before entering the intersection of 63rd Street.
All vehicles traveling north and south on 31st Avenue shall stop before entering the intersection with 43rd Street.
All vehicles traveling on 55th Street shall stop before entering the intersection with 31st Avenue.
All vehicles traveling on 56th Avenue shall stop before entering the intersection with 46th Street.

CODE OF GENERAL ORDINANCES, 2021 - KENOSHA, WISCONSIN

All vehicles traveling North/South on 17th Avenue shall stop before entering the intersection with 67th Street.

All vehicles traveling Northbound on 16th Street shall stop before entering the intersection with 67th Street.

All vehicles traveling southbound on 6th Avenue "A" shall stop before entering the intersection with 59th Place.

All vehicles traveling on 34th Avenue shall stop before entering the intersection with 55th Street.

All vehicles traveling East and West on 87th Place shall stop before entering the intersection of 17th Avenue.

All vehicles traveling southbound on 15th Avenue shall stop before entering the intersection of 67th Street.

All vehicles traveling East and West on 78th Street shall stop before entering the intersection with 27th Avenue.

All vehicles traveling northbound on 42nd Avenue shall stop before entering the intersection with 83rd Street.

All vehicles traveling on 78th Street shall stop before entering the intersection with 5th Avenue.

All vehicles traveling on 53rd Street shall stop before entering the intersection with 31st Avenue.

All vehicles traveling North and South on 35th Avenue shall stop before entering the intersection with 78th Street.

All vehicles traveling southbound on 106th Avenue shall stop before entering the intersection with 69th Street.

All vehicles traveling North and South on 32nd Avenue shall stop before entering the intersection with 76th Street.

All vehicles traveling North and South on 46th Avenue shall stop before entering the intersection with Roosevelt Road.

All vehicles traveling eastbound on 55th Street shall stop before entering the intersection with 95th Avenue.

All vehicles traveling southbound on 95th Street shall stop before entering the intersection with 58th Place.

All vehicles traveling southbound on 70th Court shall stop before entering the intersection with 74th Place.

All vehicles traveling East/West on 74th Place shall stop before entering the intersection with 70th Avenue.

All vehicles traveling North/South on 40th Avenue shall stop before entering the intersection with 53rd Street.

All vehicles traveling East/West on 40th Street shall stop before entering the intersection with 29th Avenue.

All vehicles traveling North/South on 37th Avenue shall stop before entering the intersection with 56th Street.

All vehicles traveling North/South on 40th Avenue shall stop before entering the intersection with 79th Street.

All vehicles traveling North/South on 58th Avenue shall stop before entering the intersection with 63rd Street.

All vehicles traveling Northbound on 16th Avenue shall stop before entering the intersection with 68th Street.

All vehicles traveling North/South on 35th Avenue shall stop before entering the intersection with 13th Street.

All vehicles traveling East/West on 81st Street shall stop before entering the intersection with 43rd Avenue.

All vehicles traveling Eastbound on 20th Place shall stop before entering the intersection with 19th Avenue.

All vehicles traveling East/West on 55th Street shall stop before entering the intersection with 24th Avenue.

All vehicles traveling North/South on 19th Avenue shall stop before entering the intersection with 36th Street.

CODE OF GENERAL ORDINANCES, 2021 - KENOSHA, WISCONSIN

All vehicles traveling North/South on 10th Avenue shall stop before entering the intersection with 38th Street.

All vehicles traveling East/West on 50th Street shall stop before entering the intersection with 52nd Avenue.

All vehicles traveling East/West on 65th Street shall stop before entering the intersection with 59th Avenue.

All vehicles traveling North/South on 20th Avenue shall stop before entering the intersection with 53rd Street.

All vehicles traveling North/South on 42nd Avenue shall stop before entering the intersection with 53rd Street.

All vehicles traveling North/South on 42nd Avenue shall stop before entering the intersection with 55th Street.

All vehicles traveling North/South on 36th Avenue shall stop before entering the intersection with 53rd Street.

All vehicles traveling North/South on 19th Avenue shall stop before entering the intersection with 26th Street.

All vehicles traveling North/South on 29th Avenue shall stop before entering the intersection with 41st Street.

All vehicles traveling on 7th Avenue shall stop before entering the intersection with 57th Street.

All vehicles traveling Southbound on 11th Avenue shall stop before entering the intersection with 59th Street.

All vehicles traveling on 59th Street shall stop before entering the intersection with 8th Avenue.

All vehicles traveling on 59th Street shall stop before entering the intersection with 10th Avenue.

All vehicles traveling on 18th Avenue shall stop before entering the intersection with 63rd Street.

All vehicles traveling East/West on 28th Street shall stop before entering the intersection with 23rd Avenue.

All vehicles traveling North/South on 41st Avenue shall stop before entering the intersection with 71st Street.

All vehicles traveling Southbound on 17th Avenue shall stop before entering the intersection with 68th Street.

All vehicles traveling Westbound on 87th Place shall stop before entering the intersection with 47th Avenue.

All vehicles traveling on 21st Avenue shall stop before entering the intersection with 51st Street.

All vehicles traveling North/South on 67th Street shall stop before entering the intersection with 106th Avenue.

All vehicles traveling North/South on 64th Street shall stop before entering the intersection with 105th Avenue.

All vehicles traveling North/South on 14th Avenue shall stop before entering the intersection with 81st Street.

All vehicles traveling East/West on 64th Street shall stop before entering the intersection with 106th Avenue.

All vehicles traveling East/West on 29th Street shall stop before entering the intersection with 19th Avenue.

All vehicles traveling Eastbound on 53rd Street shall stop before entering the intersection with 68th Avenue.

All vehicles traveling Southbound on 45th Avenue shall stop before entering the intersection with Pershing Boulevard.

All vehicles traveling North/South on 99th Avenue shall stop before entering the intersection with 55th Street.

All vehicles traveling Southbound on 99th Avenue shall stop before entering the intersection with 58th Place.

All vehicles traveling North/South on 32nd Avenue shall stop before entering the intersection with 55th Street.

All vehicles traveling East/West on 34th Street shall stop before entering the intersection with 55th Avenue.

CODE OF GENERAL ORDINANCES, 2021 - KENOSHA, WISCONSIN

All vehicles traveling North/South on 25th Avenue shall stop before entering the intersection with 48th Street.

All vehicles traveling North/South on 106th Avenue shall stop before entering the intersection with 63rd Street.

All vehicles traveling North/South on 8th Avenue shall stop before entering the intersection with 40th Street.

All vehicles traveling East/West on 65th Street shall stop before entering the intersection with 57th Avenue.

All vehicles traveling East/West on 26th Street shall stop before entering the intersection with 21st Avenue.

All vehicles traveling North/South on 28th Avenue shall stop before entering the intersection with 48th Street.

All vehicles traveling East/West on 15th Place shall stop before entering the intersection with 27th Avenue.

All vehicles traveling North/South on 40th Avenue shall stop before entering the intersection with 13th Place.

All vehicles traveling Eastbound on 54th Street shall stop before entering the intersection with 68th Avenue.

All vehicles traveling Eastbound on 55th Street shall stop before entering the intersection with 68th Avenue.

All vehicles traveling Eastbound on 57th Street shall stop before entering the intersection with 3rd Avenue.

All vehicles traveling Westbound on 67th Street shall stop before entering the intersection with 99th Avenue.

All vehicles traveling Southbound on 99th Avenue shall stop before entering the intersection with 68th Street.

All vehicles traveling Northbound on 16th Avenue shall stop before entering the intersection with 54th Street.

All vehicles traveling North/South on 29th Avenue shall stop before entering the intersection with 48th Street.

All vehicles traveling Southbound on 40th Court shall stop before entering the intersection with 15th Street.

All vehicles traveling East/West on 50th Street shall stop before entering the intersection with 25th Avenue.

All vehicles traveling North/South on 50th Avenue shall stop before entering the intersection with 33rd Street.

All vehicles traveling East/West on 58th Street shall stop before entering the intersection with 5th Avenue.

All vehicles traveling North/South on 35th Avenue shall stop before entering the intersection with 76th Street.

All vehicles traveling North/South on 35th Avenue shall stop before entering the intersection with 77th Street.

All vehicles traveling Eastbound on 62nd Place shall stop before entering the intersection with 94th Court.

All vehicles traveling Eastbound on 65th Street shall stop before entering the intersection with 87th Avenue.

All vehicles traveling Southbound on 83rd Avenue shall stop before entering the intersection with 65th Street.

All vehicles traveling Eastbound on 61st Street shall stop before entering the intersection with 82nd Avenue.

All vehicles traveling Westbound on 65th Street shall stop before entering the intersection with 96th Avenue.

All vehicles traveling Westbound on 67th Street shall stop before entering the intersection with 111th Avenue.

All vehicles traveling Westbound on 65th Street shall stop before entering the intersection with 92nd Avenue.

CODE OF GENERAL ORDINANCES, 2021 - KENOSHA, WISCONSIN

All vehicles traveling on 25th Court shall stop before entering the intersection with 25th Avenue.
All vehicles traveling Northbound on 36th Avenue shall stop before entering the intersection with 23rd Street.
All vehicles traveling Southbound on 35th Avenue shall stop before entering the intersection with 23rd Street.
All vehicles traveling north/south on 18th Avenue shall stop before entering the intersection with 48th Street.
All vehicles traveling Westbound on 48th Street shall stop before entering the intersection with 38th Avenue.
All vehicles traveling eastbound on 51st Street shall stop before entering the intersection with 68th Avenue.
All vehicles traveling East on 25th Street shall stop before entering the intersection with 14th Avenue.
All vehicles traveling Southbound on 68th Avenue shall stop before entering the intersection with 56th Street.
All vehicles traveling East/West on 69th Street shall stop before entering the intersection with 5th Avenue.
All vehicles traveling North/South on 15th Avenue shall stop before entering the intersection with 79th Street.
All vehicles traveling Southbound on 16th Avenue shall stop before entering the intersection with 79th Street.
All vehicles traveling East/West on 62nd Place shall stop before entering the intersection with 95th Avenue.
All vehicles traveling North/South on 19th Avenue shall stop before entering the intersection with 45th Street.
All vehicles traveling East/West on 37th Street shall stop before entering the intersection with 19th Avenue.
All vehicles traveling North/South on 18th Avenue shall stop before entering the intersection with 78th Street.
All vehicles traveling North/South on 38th Avenue shall stop before entering the intersection with 23rd Street.
All vehicles traveling West on 61st Street shall stop before entering the intersection with 13th Avenue.
All vehicles traveling Southbound on 64th Avenue shall stop before entering the intersection with 76th Street.
All vehicles traveling Southbound on 25th Avenue shall stop before entering the intersection with 69th Street.
All vehicles traveling North/South on 8th Avenue shall stop before entering the intersection with 45th Street.
All vehicles traveling North/South on 28th Avenue shall stop before entering the intersection with 40th Street.
All vehicles traveling east on 60th Street shall stop before entering the intersection with 8th Avenue.
All vehicles traveling East/West on 53rd Street shall stop before entering the intersection with 43rd Avenue.
All vehicles traveling East/West on 76th Street shall stop before entering the intersection with 33rd Avenue.
All vehicles traveling North/South on 15th Avenue shall stop before entering the intersection with 81st Street.
All vehicles traveling East/West on 57th Street shall stop before entering the intersection with 37th Avenue.

7.125 STREETS CONTROLLED BY YIELD SIGNS

All vehicles traveling on the public thoroughfares listed in Column "A" shall yield the right of way in the manner specified in §346.18(6), Wisconsin Statutes, before entering the public thoroughfares listed in Column "B":

CODE OF GENERAL ORDINANCES, 2021 - KENOSHA, WISCONSIN

COLUMN "A"

COLUMN "B"

Adams Road	54th Avenue
Buchanan Road	25th Avenue
Washington Road	5th Avenue
Washington Road	6th Avenue
6th Avenue	40th Street
6th Avenue	42nd Street
6th Avenue	78th Street
7th Avenue	68th Street
10th Avenue	73rd Street
10th Avenue	62nd Street
11th Avenue	62nd Street
15th Avenue	61st Street
15th Avenue	78th Street
16th Avenue	37th Street
16th Avenue	38th Street
16th Avenue	78th Street
16th Place	16th Avenue
16 th Place	27 th Avenue
16th Place	32nd Avenue
16 th Street	27 th Avenue
17th Avenue	16th Avenue
17th Avenue	36th Street
17th Avenue	38th Street
18th Place	16th Avenue
19th Avenue	28th Street
19th Avenue	33rd Street
19th Avenue	37th Street
19th Avenue	38th Street
19th Avenue	79th Street
21st Avenue	33rd Street
21st Avenue	34th Street
21st Avenue	37th Street
21st Avenue	38th Street
22nd Street	35th Avenue
23rd Avenue	32nd Street
23rd Avenue	46th Street
23rd Avenue	78th Street
24th Avenue	28th Street
24th Avenue	32nd Street
24th Avenue	48th Street
24th Avenue	76th Street
25th Avenue	21st Street
25th Avenue	46th Street
25th Avenue	76th Street
25th Place	19th Avenue
25th Street	17th Avenue
25th Street	21st Avenue
26th Street	24th Avenue
26th Street	25th Avenue
26th Street	27th Street
28th Street	21st Avenue
28th Street	50th Avenue
29th Avenue	46th Street

CODE OF GENERAL ORDINANCES, 2021 - KENOSHA, WISCONSIN

30th Avenue	52nd Street
31st Avenue	74th Street
32nd Avenue	71st Street
32nd Street	50th Avenue
32nd Street	55th Avenue
33rd Avenue	29th Street
33rd Avenue	71st Street
33rd Avenue	74th Street
33rd Street	55th Avenue
34th Avenue	24th Street
34th Court	24th Street
34th Street	19th Avenue
35th Avenue	14th Place
35th Avenue	53rd Street
35th Avenue	69th Street
35th Court	85th Place
35th Place	17th Avenue
35th Place	18th Avenue
35th Place	19th Avenue
36th Avenue	25th Street
36th Avenue	29th Street
36th Avenue	68th Street
36th Avenue	70th Street
36th Street	16th Avenue
36th Street	19th Avenue
36th Street	21st Avenue
37th Avenue	48th Street
37th Avenue	56th Street
37th Avenue	59th Street
37th Avenue	71st Street
38th Avenue	55th Street
38th Avenue	57th Street
38th Avenue	67th Street
38th Avenue	70th Street
40th Avenue	13th Place
40th Avenue	65th Street
41st Avenue	57th Street
41st Street	31st Avenue
42nd Avenue	65th Street
42nd Avenue	Harding Road
43rd Avenue	55th Street
43rd Avenue	65th Street
44th Avenue	Harding Road
44th Street	6th Avenue
44th Street	18th Avenue
45th Street	Kennedy Drive
46th Avenue	58th Street
46th Avenue	Harding Road
46th Street	24th Avenue
46th Street East	28th Avenue
47th Court	Roosevelt Road
48th Avenue	24th Place/47th CT
48th Avenue	79th Street
48th Street	8th Avenue
49th Street	5th Avenue
49th Street	8th Avenue

CODE OF GENERAL ORDINANCES, 2021 - KENOSHA, WISCONSIN

51st Avenue	41st Street
51st Street	8th Avenue
53rd Avenue	41st Street
53rd Court	24th Place
53rd Street	25th Avenue
53rd Street	34th Avenue
53rd Street	36th Avenue
53rd Street	37th Avenue
53rd Street	38th Avenue
53rd Street	41st Avenue
53rd Street	46th Avenue
54th Avenue	41st Street
54th Street	55th Avenue
55th Avenue	26th Street
55th Avenue	28th Street
55th Avenue	31st Street
55th Street	16th Avenue
55th Street	37th Avenue
55th Street	40th Avenue
55th Street	41st Avenue
55th Street	44th Avenue
55th Street	46th Avenue
56th Avenue	49th/50th Street
56th Street	35th Avenue
56th Street	40th Avenue
56th Street	41st Avenue
56th Street	43rd Avenue
56th Street	44th Avenue
57th Street	35th Avenue
58th Avenue	68th Street
59th Street	14th Avenue
59th Street	35th Avenue
59th Street	41st Avenue
60th Place	38th Avenue
60th Place	115th Avenue
61st Street	11th Avenue
61st Street	25th Avenue
61st Street	Wilson Road/40th Avenue
63rd Avenue	53rd Street
63rd Street	32nd Avenue
64th Street	10th Avenue
64th Street	11th Avenue
64th Street	54th Avenue
65th Street	99th Avenue
66th Street	24th Avenue
66th Street	25th Avenue
66th Street	31st Avenue
66th Street	32nd Avenue
68th Street	23rd Avenue
68th Street	35th Avenue
68th Street	49th Avenue
69th Street	36th Avenue
69th Street	37th Avenue
69th Street	38th Avenue
70th Street	16th Avenue

CODE OF GENERAL ORDINANCES, 2021 - KENOSHA, WISCONSIN

70th Street	31st Avenue
70th Street	35th Avenue
70th Street	37th Avenue
70th Street	155th Avenue
71st Street	2nd Avenue
71st Street	18th Avenue
71st Street	31st Avenue
71st Street	36th Avenue
72nd Street	16th Avenue
72nd Street	18th Avenue
72nd Street	Roundabout
73rd Street	2nd Avenue
73rd Street	5th Avenue
73rd Street	18th Avenue
73rd Street	33rd Avenue
74th Street	16th Avenue
74th Street	32nd Avenue
74th Street	35th Avenue
74th Street	36th Avenue
74th Street	96th Avenue
76th Street	15th Avenue
76th Street	16th Avenue
76th Street	19th Avenue
76th Street	31st Avenue
76th Street	32nd Avenue
77th Street	6th Avenue
77th Street	40th Avenue
78th Place	16th Avenue
78th Street	3rd Avenue
78th Street	10th Avenue
78th Street	40th Avenue
78th Street	70th Avenue
81st Street	43rd Avenue
85th Avenue	66th Street
93rd Avenue	63rd Street
94th Avenue	63rd Street
100th Avenue	68th Street
102nd Avenue	68th Street
114th Avenue	62nd Street
144th Avenue	Roundabout

7.126 MOTOR VEHICLES - NUISANCES - REPAIR WORK

A. Purpose. The purpose of this Ordinance is to prevent blight, to secure healthy and humane living conditions, to protect the integrity of investments in real property, to prevent the decline of real estate values, to improve aesthetics and to protect the public health, safety and welfare. In order to secure this goal, activities contrary to this Ordinance are deemed to constitute a matter of public concern which must be regulated or prescribed through the exercise of the City's police powers.

B. Definitions.

1. "Motor Vehicle(s)" shall include mobile home, moped, motor bicycle, motor bus, motorcycle, motor-driven cycle, motor home, motor truck and motor vehicle as defined in Chapter 340, Wisconsin Statutes.

CODE OF GENERAL ORDINANCES, 2021 - KENOSHA, WISCONSIN

2. **"Nuisance Motor Vehicle(s)"** shall include any inoperable, unlicensed, unroadworthy, disassembled or wrecked motor vehicle. A vehicle for which a license has been applied for shall be herein deemed a licensed vehicle if proof of application is prominently displayed on the front windshield.

3. **"Repair Work"** shall include mechanical, electrical and body work, maintenance, construction, reconstruction, assembly, disassembly, restoration, painting, upholstering or any similar or related work performed on any motor vehicle.

4. **"Street Repairs"** shall mean "temporary repair work" performed on a motor vehicle in a manner and place which will not create a danger or hazard to vehicular or pedestrian traffic.

5. **"Temporary Repair Work"** shall mean repair work which is performed within twenty-four (24) hours of a motor vehicle becoming unexpectedly unroadworthy on a street, highway or thoroughfare, which work will make or attempts to make said motor vehicle roadworthy.

6. **"Owner"** shall mean a person who holds the legal title of a vehicle, except that if the legal title is held by a secured party with the immediate right of possession of the vehicle vested in the debtor, the debtor is the Owner. Notwithstanding the foregoing with respect to a vehicle that is leased for a period of one year or more, the lessee of the vehicle.

C. Prohibition. It shall be unlawful for the "owner" of a nuisance motor vehicle to keep, place or store any "nuisance motor vehicle" or for any person to perform "repair work" or "street repairs" upon any public thoroughfare, street or highway or upon any private or public property within the City in a manner inconsistent with this Ordinance.

D. Repair Work - Limitations. "Repair work" may be performed upon observance of the following conditions and restrictions:

1. **"Repair work"** upon residentially zoned private property cannot be performed for financial gain or profit obtained through fees, barter, charges or appreciation in the value of a motor vehicle purchased for the purpose of resale. "Repair work" upon other than residentially zoned property shall be in accordance with the City Zoning Ordinances and in compliance with applicable State and City laws, rules and regulations, licenses and permits.

2. Except for authorized street repairs, "repair work" which renders a motor vehicle inoperable for a period of more than three (3) working days, must be performed in a garage or enclosed structure or fenced in area which screens repair work from the view of the owners, users and occupiers of abutting and neighboring properties and from the view of passersby using public thoroughfares, streets and highways.

3. **"Street repairs"** may be performed only within the scope of the definition thereof.

E. Nuisance Motor Vehicles - Limitations. "Nuisance motor vehicles" may be kept, placed or stored outside of a garage or enclosed structure only in conjunction with a duly authorized and licensed auto sales, repair or salvage business lawfully operating within a properly zoned area and in compliance with all State and local laws, rules, regulations, licenses and permits.

F. Nuisance Motor Vehicles - Removal.

1. **Authority To Tow.** Subject to the procedures hereinafter set forth, Nuisance Motor Vehicles may be towed and stored by the Police Department, at the cost and expense of the owner thereof, pursuant to §13.12 of the Code of General Ordinances. Unclaimed towed vehicles may be disposed of by towers through means and procedures authorized by law.

2. **Notice Of Intent To Tow - Private Property.** The owner of a Nuisance Motor Vehicle which is upon private property shall be notified of a violation of this Ordinance, and provided with ten (10) full calendar days to repair, assemble, make the vehicle operable and roadworthy and license any vehicle which may not be licensed or, in the alternative, place such vehicle in a garage or enclosed structure or

CODE OF GENERAL ORDINANCES, 2021 - KENOSHA, WISCONSIN

place such vehicle within a duly authorized and licensed sales, repair or salvage business lawfully operating within a properly zoned area and in compliance with all State and local laws, rules, regulations, licenses and permits.

3. Notice of Intent To Tow - Public Property And Right-Of-Ways. The owner of a Nuisance Motor Vehicle which is upon public property or right-of-ways shall be notified of a violation of this Ordinance and provided with twenty-four (24) hours to repair, assemble, make the vehicle operable and roadworthy and license any vehicle which may not be licensed or, in the alternative, place such vehicle in a garage or enclosed structure or place such vehicle within a duly authorized and licensed sales, repair or salvage business lawfully operating within a properly zoned area and in compliance with all State and local laws, rules, regulations, licenses and permits.

4. Service Of Notice Of Intent To Tow - Computation Of Time - Private Property. A notice of intent to tow a nuisance motor vehicle which is upon private property shall be served upon the owner of the vehicle by posting, on the front windshield, a sticker which shall advise the nature of the violation, the time for compliance, and a phone number to call should the owner of the nuisance motor vehicle desire to be heard prior to the expiration of the ten (10) days. The ten (10) day time limit provided to procure voluntary compliance with this Ordinance shall commence to run the day after the nuisance motor vehicle is posted. In addition to the sticker, where the vehicle is currently registered, a courtesy notice of the intent to tow shall be mailed by first class mail to the owner of record of the nuisance motor vehicle.

5. Service Of Notice Of Intent To Tow - Computation Of Time - Public Property, Streets, Alleys And Right-Of-Ways. If the owner of a Nuisance Motor Vehicle which vehicle is upon any public property, street, alley or right-of-way can be reasonable determined, said owner shall be given oral and/or written notice of intent to tow and in addition thereto, a stick-on or otherwise waterproofed and fastened notice of intent to tow shall be posted on the Nuisance Motor Vehicle, which notice shall be deemed adequate in the event that there is no oral and/or written notice of intent to tow provided to the Nuisance Motor Vehicle owner. The twenty-four (24) hour time limit provided to procure voluntary compliance with this Ordinance shall commence to run at such time as the Nuisance Motor Vehicle is posted.

6. Extensions Of Time. The Police Department, for good cause, upon the Nuisance Motor Vehicle owner's request, may grant a reasonable extension of any time limit imposed herein to enable a Nuisance Motor Vehicle owner to voluntarily comply with this Ordinance.

7. Other Ordinances And Laws. A Nuisance Motor Vehicle may be towed under authority of any other Ordinance or law pursuant to procedures therein specified, where a tow is authorized by another Ordinance or law for reason other than a violation of this Ordinance.

8. Non-Tolling Of Period Of Time Provided To Comply With This Ordinance. The period of time with which an owner of a Nuisance Motor Vehicle is provided hereunder to comply with this Ordinance in order to avoid a tow, shall not be tolled by the fact of a temporary removal of said vehicle from the place whereupon the violation of this Ordinance was noticed to occur under circumstances where the vehicle continues to be a Nuisance Motor Vehicle.

9. Sanction For Noncompliance. The owner of a Nuisance Motor Vehicle who fails, in a timely manner, to comply with this Ordinance shall be subject to have their Nuisance Motor Vehicle towed and stored at their expense and shall, as hereinafter provided, be subject to a money forfeiture and to potential imprisonment in the County Jail as provided for in the Penalty Section of this Chapter of the Code of General Ordinances should a court imposed forfeiture not be paid in a timely manner. Each day of violation of this Ordinance shall be deemed a separate offense. A citation for a violation of this Ordinance is not a precondition to a Nuisance Motor Vehicle being towed under authority of this Ordinance.

10. Hearing. The notice of intent to tow shall provide the owner of a Nuisance Motor vehicle with an opportunity to request a hearing before a designee of the Police Chief to enforce this Ordinance. Where a hearing is requested within the time provided for Ordinance compliance in the notice, no action shall be taken to tow the vehicle or issue a citation hereunder until the hearing is held. However, said owner may be required to appear for a hearing to be scheduled within twenty-four (24) hours of the request. The failure of the owner to appear at a scheduled hearing shall constitute a waiver of said right to a hearing.

CODE OF GENERAL ORDINANCES, 2021 - KENOSHA, WISCONSIN

Hearings may be conducted over the telephone at the request of or with the consent of the Nuisance Motor Vehicle owner. The purpose of a hearing hereunder is to permit the Nuisance Motor Vehicle owner to show that the Nuisance Motor Vehicle sought to be towed is not, in fact, a Nuisance Motor Vehicle which is subject to tow hereunder. The person conducting said hearing, which shall be informal, shall note in writing the facts presented and position of the Nuisance Motor Vehicle owner, shall mark and retain exhibits and shall determine, in writing, whether or not this Ordinance has been violated. If this Ordinance has been determined by said person to have been violated, the Nuisance Motor Vehicle owner shall be notified of a compliance date, which shall be reasonable under all of the circumstances.

11. Appeal. Appeal shall be as hereinafter provided, the City electing not to be governed by Chapter 68, Wisconsin Statutes.

An aggrieved party desiring to appeal from a hearing determination under Subsection **10.**, may file a written Notice of Appeal which must be received by the Police Department prior to the expiration of the time for compliance with this Ordinance provided for in the Notice of Intent to Tow. The Notice of Appeal shall state the error alleged in the initial decision and shall provide the address and phone number of appellant. The appeal shall be heard by a designee of the Director of Public Works. The review shall be upon the record and a written determination affirming or denying the initial decision maker shall be made. No vehicles shall be towed until the appeal process is completed, and then only where the decision of the initial decision maker finding a violation of this Ordinance is upheld, and only after the appellant has been notified of the appeal decision and given at least twenty-four (24) hours to comply with this Ordinance. Further appeal would be by Writ of Certiorari to the Circuit Court.

12. Notice of Towing. Where a Nuisance Motor Vehicle is towed hereunder and where the owner and owner's address of the towed vehicle is known or reasonably ascertainable to the person who authorized the tow, said owner shall be provided notice, either personally or by regular mail, that the vehicle has been towed by a certain tower to a certain location. The owner shall be provided with tower's phone number and advised that the vehicle should be claimed therefrom, upon payment of the appropriate towing and storage charges, as soon as possible, for daily storage charges are accumulating. The notice shall also indicate that the vehicle may be disposed of by the tower, to recoup such charges in a manner and through a procedure authorized by law.

13. Agreement to Defend, Indemnify and Hold Harmless. The City will defend or pay for the defense of any tower towing under this Ordinance and will indemnify and hold harmless any tower towing under this Ordinance from any loss, damages, costs or expenses which they may sustain, incur or be required to pay should any person or party make claim or commence a lawsuit against any such tower where the basis for the claim or lawsuit is an allegation that this Ordinance is unconstitutional on its face or in its application. A prerequisite for the above City obligation is written notice by a tower of a claim or lawsuit to the City Clerk, within five (5) days of the receipt thereof, and a tender of the defense thereof to the City.

7.127 DISTRIBUTION OF LITERATURE PROHIBITED

The distribution of written literature is prohibited, whether or not a charge or donation is requested therefor, within the street right-of-way to a distance of 50 feet from the following intersections:

35th Street and 22nd Avenue
52nd Street and 22nd Avenue
60th Street and Sheridan Road
75th Street and 22nd Avenue
75th Street and 39th Avenue
and Roosevelt Road 85th
Street and 22nd Avenue

during the hours of 7:30 A.M. to 8:15 A.M.; 11:00 A.M. to 12:30 P.M.; and 2:30 P.M. to 4:00 P.M. on school days of Unified School District No. 1. The street right-of-way shall include the portion of the street used for vehicular traffic, the lawn park area and the City sidewalk.

CODE OF GENERAL ORDINANCES, 2021 - KENOSHA, WISCONSIN

7.128 TOWING OF ILLEGALLY PARKED VEHICLES

A. Towing. Vehicles illegally parked on a highway having any of the following:

1. Two (2) or more open warrants of any kind and/or commitments;
2. Two (2) or more open parking citations more than thirty (30) days old;
3. No plates and the VIN number identifies the vehicle owner as having two (2) or more open parking citations more than thirty (30) days old;
4. One (1) open warrant/commitment and one (1) open parking citation more than thirty (30) days old; shall, following the issuance of a parking citation, be towed by a City licensed tower at the request of the City Police Department.

B. Towing Fees and Storage Charges. As a condition of reclaiming a towed vehicle, towing fees and storage charges, if any, shall be paid by the owner of the towed vehicle in accordance with the schedule of towing fees and storage charges provided for in §13.12 of the Code of General Ordinances. Towers shall have mechanic's lien rights on towed vehicles for towing fees and storage charges, if any. In the event of the nonpayment of towing fees and/or storage charges, towers may, in accordance with procedures prescribed by law, dispose of towed vehicles.

C. Claiming Towed Vehicle. To claim a towed vehicle, claimant must show evidence of proof of ownership to the tower. In the event the tower is not satisfied that the evidence shown clearly demonstrates ownership, the tower may require the claimant to obtain an authorization for the release of the vehicle from the City Police Department. A towed vehicle must be released to the owner if the towing fee and storage charges, if any, are paid. The owner need not pay for any citation or respond to any citation, warrant or commitment as a condition of reclaiming the towed vehicle.

D. Notice of Tow. The City Police Department shall, within twenty-four (24) hours after the tow of an illegally parked vehicle, send by first class mail written notice to the last known registered owner of the towed vehicle at the last known address of said registered owner, as shown by records of the State Department of Transportation, informing said registered owner of the fact of the tow, of the citation issued for illegal parking and of the owner's right to a hearing as herein provided.

E. Hearing. Citation recipients wishing to contest the legality of the citation and of the tow resulting therefrom may obtain a "review" of same by an attorney within the City Attorney's Office within one (1) business day of the receipt of a written request therefor by the City Attorney's Office. At this review, the citation recipient may challenge the basis for the tow and/or citation and may bring witnesses to support their position. If an attorney within the City Attorney's Office determines, following review, that there was probable cause to issue the citation and tow the vehicle, the vehicle may be retained by the tower, unless towing fees and storage charges, if any, are paid and the citation will be processed through the Municipal Court where the citation recipient will be entitled to a full hearing on the merits thereof. In the event that an attorney within the City Attorney's Office determines that there was no probable cause, the citation shall be voided and the towed vehicle, if still in the custody of the tower, will be released immediately without payment of any towing fees or storage charges to the citation recipient. In the event that the citation recipient has previously claimed the towed vehicle and paid the relevant fees and charges therefor, the citation recipient shall be reimbursed for said payment by the City. In the event that the towed vehicle is still in the custody of the tower, the City will reimburse the tower for the relevant fees and charges.

F. Policy and Procedure. Prior to towing vehicles under this Ordinance, the Police Department shall put into effect a policy and procedure which has been approved by the City Attorney which outlines the administration and enforcement of this Ordinance. Said policy and procedure will be incorporated into this Ordinance by reference and shall be considered a part hereof as if fully set forth herein. A copy thereof shall be filed with the Municipal Court.

CODE OF GENERAL ORDINANCES, 2021 - KENOSHA, WISCONSIN

7.129 PARKING OF CERTAIN MOTOR VEHICLES AND EQUIPMENT PROHIBITED ON THE EXTERIOR OF ANY RESIDENTIAL PROPERTY AND ON ANY PUBLIC STREET, HIGHWAY, ALLEY, THOROUGHFARE OR RIGHT-OF-WAY IN ANY RESIDENTIAL ZONING DISTRICT OF THE CITY

A. Definitions.

1. "**Commercial**" shall mean for profit or gain, whether full time, part time or incidental.
2. "**Exterior**" shall mean outside of a fully enclosed garage or structure.
3. "**Non-Commercial Pickup Truck**" shall mean a four wheel motor vehicle, having an enclosed cab and an open body with low sides and tailgate, used or maintained privately for the transportation of property solely for personal use.
4. "**Prohibited Motor Vehicles and Equipment**" shall mean commercial trucks and buses, recreational motor vehicles over twenty-four (24') feet in length, a piece of mobile machinery or equipment, such as ditch digging apparatus, power shovels, drag lines and earthmoving equipment, or a piece of road construction or maintenance machinery, such as asphalt spreaders, bituminous mixers, bucket loaders, ditchers, leveling graders, finishing machines, motor graders, paving mixers, road rollers, scarifiers, gravel crushers, screening plants, scrapers, tractors, earth movers, front or rear end loaders, conveyors or road pavers, buses, flatbed trucks, semitrailers, semicabs, trailers, coupled or uncoupled, trailers used for landscaping and lawn maintenance equipment, homemade trailers, skid-steer loaders, dump trucks, tow trucks, or street sweepers.
5. "**Park(ed)(ing)**" shall mean to park, store, stand or keep.
6. "**Recreational Vehicles**" shall mean non-commercial vehicles/equipment designed or used for recreational purposes.
7. "**Residential Property**" shall mean real property zoned or used for a residential purpose, under the City Zoning Ordinance.
8. "**Residential Zoning District**" shall mean a City Zoning District where the residential use of property is a permitted or conditional use, as well as any streets, highways or public areas abutting or directly adjacent to a City zoning district where the residential use of property is a permitted or conditional use.

B. Prohibition.

1. It shall be unlawful, except as hereinafter provided, for any owner, agent, operator, or person in charge of any Prohibited Motor Vehicle and Equipment, whether or not used for a commercial purpose, to park, cause to be parked or allow to be parked, such Prohibited Motor Vehicle and Equipment on the exterior of any residential property, or on any public street, highway, alley, thoroughfare, or right-of-way in any residentially zoned district in the City, for a period in excess of one (1) hour, unless engaged in lawful construction work, having all licenses, permits and approvals, where required, which are in full force and effect, customer service activity, repair work, home improvement work, or loading or unloading activities, and, in which event, such Prohibited Motor Vehicle and Equipment shall be promptly removed upon completion of any such activity. This prohibition is subject to the exceptions set forth in **Subsection C.** below.
2. It shall be unlawful, except as hereinafter provided, for any owner, lessee, agent, or person in charge of any residential property to park, cause to be parked, or allow to be parked, any Prohibited Motor Vehicle and Equipment, whether or not used for a commercial purpose, on the exterior of any residential property for a period in excess of one (1) hour, unless engaged in lawful construction work, having all licenses, permits and approvals, where required, which are in full force and effect, customer service activity, repair work, home improvement work, or unless engaged in loading or unloading activities, in which event such Prohibited Motor Vehicle and Equipment shall be promptly removed upon completion of such activity. This prohibition is subject to the exceptions set forth in **Subsection C.** below.

CODE OF GENERAL ORDINANCES, 2021 - KENOSHA, WISCONSIN

C. Exception. Subsections B.1. and 2. are subject to the following parking exceptions:

1. One (1) bus, flatbed truck used for towing motor vehicles, flatbed truck on pickup truck body, or tow truck used for a commercial purpose, may be parked on the exterior of any residential property, in excess of one (1) hour, subject to compliance with the special conditions in Subsection D.
2. Any pickup truck, tractor or truck which is rendering service or loading or unloading materials.
3. Non-Commercial Pickup Trucks with clean or covered beds, without advertising or stakes inserted in the sides, or bumpers raised more than twenty-six (26") inches from the street.
4. A motor vehicle registered to a public utility, as that term is defined by Wisconsin Statutes §196.01(5).

D. Special Conditions. The following Special Conditions shall apply to the exception in Subsection C.:

1. Prohibited Motor Vehicle and Equipment shall be parked off a public street, highway, alley, thoroughfare or right-of-way.
2. Prohibited Motor Vehicle and Equipment parking shall not occur between the street and the front wall of the building or an imaginary line extended parallel to such front wall.
3. Prohibited Motor Vehicle and Equipment shall not be parked on a vacant lot.
4. Prohibited Motor Vehicle and Equipment shall be parked on a parking surface paved with concrete or asphalt.
5. A Recreational Motor Vehicle over twenty-four (24) feet in length, on any public street, highway, alley, thoroughfare, or right-of-way in any residentially zoned district in the City between the hours of 2:00 A.M. and 7:00 A.M. for more than thirty (30) minutes.

E. Other Ordinances. This Ordinance shall not affect the application and enforcement of any other Ordinance on the same subject matter. In the event of a conflict, the stricter Ordinance shall apply.

F. Enforcement. This Ordinance shall be enforced by the Kenosha Police Department. The Police Department shall authorize the towing of unlawfully parked Prohibited Motor Vehicles and Equipment under Section 7.128 of the Code of General Ordinances. The Police Department will post a sticker on the front windshield of a Prohibited Motor Vehicle and on the front end of a piece of Prohibited Equipment, providing a notice of intent to tow.

G. Penalty. Any person violating this Ordinance, upon conviction thereof, shall forfeit not more than Fifty (\$50.00) Dollars for each violation. Each day of violation shall be a separate violation. Each motor vehicle and equipment parked in violation of this Ordinance shall be a separate violation.

7.13 MISCELLANEOUS

A. Audible Signals. Vehicles shall give audible signals only in an emergency or when a warning to other vehicles and pedestrians is required for their safety.

B. Visible Signals. Operators of all vehicles shall extend their hand or give some other visible signal of their intention to stop, back, turn, slow, or change their course.

C. Trick Riding. No bicycle or motorcycle shall be operated with the feet off the pedals or both hands off the handle bars. Trick riding in any street is prohibited.

CODE OF GENERAL ORDINANCES, 2021 - KENOSHA, WISCONSIN

D. Turns.

1. No Left Turns.

Between the hours of 6 A. M. and 6 P. M., except Sundays and holidays, no vehicle traveling north on 20th Avenue shall turn left at 60th Street.

No vehicle traveling west on Roosevelt Road shall make a left-hand turn at 39th Avenue.

No vehicle traveling north and exiting the Pershing Plaza Shopping Center at a driveway opposite 43rd Avenue shall make a left-hand turn onto 75th Street.

No vehicle traveling north on 13th Avenue shall make a left turn into 56th Street.

No vehicle traveling Southbound on 22nd Avenue shall make a left turn onto 63rd Street.

No vehicle shall turn left or travel straight from eastbound 87th Place at 30th Avenue between 7:00AM - 7:30AM on school days.

No vehicle traveling southbound on 98th Avenue shall make a left turn into the southeast entrance to Nash Elementary School between the hours of 7:00 a.m. - 9:00 a.m. and 2:00 p.m. - 4:00 p.m. on school days.

E. Advertising. No person shall operate or park on any street any vehicle for the primary purpose of advertising.

F.1. Declaration of Emergency. The Director of Public Works, or in his/her absence the City Administrator, or in their absence, the Director of Engineering, may, in their discretion, declare an emergency to exist in the City, or in a section or sections thereof, for one (1) or more periods of seventy-two (72) hours, where snow, freezing rain, sleet, ice, snow drifts, flooding or other phenomena cause, or are likely to cause, hazardous road conditions on City streets or highways, which conditions will or may endanger the public health, safety or welfare, or which conditions will or may impede the movement of emergency vehicles or other vehicular traffic.

2. Snow Emergency Streets.

a. "Snow Emergency Streets". An emergency shall exist on "Snow Emergency Streets" when snow or sleet accumulates to a depth of two (2) inches in any twenty-four (24) hour period measured at the Street Department Garage. "Snow Emergency Streets" shall be as follows, and such streets shall be marked accordingly:

Pershing Boulevard - 60th Street to 80th Street;
Roosevelt Road - 39th Avenue to 22nd Avenue;
Sheridan Road - 75th Street to 91st Street;
Streets Around Library Park;

Washington Road - North Side - 30th Avenue to 32nd Avenue;
Washington Road - Sheridan Road to 7th Avenue;
Washington Road - Sheridan Road to 30th Avenue.

7th Avenue - 50th Street to Sheridan Road;
7th Avenue - 50th Street to 51st Place - (sign only non-metered area);
7th Avenue - 61st to 80th Street;
8th Avenue - 61st Street to 64th Street;
18th Avenue - 75th Street to 60th Street;
22nd Avenue - 60th Street to Birch Road;
22nd Avenue - 75th Street to Roosevelt Road;
22nd Avenue - 76th Street to 87th Place;

CODE OF GENERAL ORDINANCES, 2021 - KENOSHA, WISCONSIN

30th Avenue - 52nd Street to Washington Road;
30th Avenue - 80th Street to 60th Street;
35th Street - 7th Avenue to 30th Avenue;
39th Avenue - 45th Street to 80th Street;
39th Avenue - Washington Road to 30th Street;
45th Street - 22nd Avenue to 47th Avenue;
49th Avenue - 52nd Street to 60th Street;
50th Street - 7th Avenue to 30th Avenue;
51st Place - 6th Avenue to 7th Avenue;
51st Avenue - 60th Street to 75th Street;
55th Street - 58th Avenue to Highway 31;
56th Street - 13th Avenue to 25th Avenue;
58th Street - 5th Avenue to 3rd Avenue;
58th Avenue - 52nd Street to 55th Street;
59th Street - 6th Avenue to 4th Avenue;
60th Street - 8th Avenue to City Limits;
62nd Street - Sheridan Road to 8th Avenue;
63rd Street - 24th Avenue to 30th Avenue;
63rd Street - Sheridan Road to 21st Avenue;
64th Street - Sheridan Road to 8th Avenue;
75th Street - 7th Avenue to Sheridan Road;
75th Street - Sheridan Road to City Limits;
80th Street - Sheridan Road to Cooper Road;
85th Street - Sheridan Road to 30th Avenue;

b. "Narrow Snow Emergency Streets". An emergency shall exist on "Narrow Snow Emergency Streets" when snow or sleet accumulates to a depth of four (4) inches in any twenty-four (24) hour period measured at the Street Department Garage. "Narrow Snow Emergency Streets" shall be as follows, and such streets shall be marked accordingly:

8th Avenue - Washington Road to 40th Street;
10th Avenue - Washington Road to 40th Street;
11th Avenue - 35th Street to 40th Street;
13th Avenue - 50th Street North to end;
13th Avenue - 73rd Street to 74th Street;
16th Avenue - 60th Street South;
47th Street - 5th Avenue to 7th Avenue;
51st Street - 17th Avenue to 18th Avenue;
58th Street - 13th Court to 14th Avenue;
60th Place - West on 20th Avenue;
63rd Place - 8th Avenue West to end;
64th Street - 7th Avenue to 8th Avenue;
66th Place - Sheridan Road to 11th Avenue;
74th Street - 13th Avenue to 14th Avenue;
78th Place - Sheridan Road to 17th Avenue.

3. Notice. When an emergency is declared pursuant to Subsection 1, notice thereof shall be given to the local news media for purposes of broadcast or printing, and furnished to the City Fire and Police Departments. Notice must be furnished no less than two hours prior to enforcement of restrictions arising out of the declared emergency.

4. Prohibition. During the period of an emergency, no motor vehicle, motor vehicle trailer, semitrailer, mobile home or other form of conveyance shall park, stop, stand or otherwise be unattended on any City street or highway:

a. At any time on any posted City "Snow Emergency Street".

b. At any time on any street in the City, after an emergency is declared under the provisions of §7.13 F.1. and proper notice being given under the provisions of §7.13 F.3.

CODE OF GENERAL ORDINANCES, 2021 - KENOSHA, WISCONSIN

5. Towing. Motor vehicles, motor vehicle trailers, semi-trailers, mobile homes or other form of conveyance in violation of this Ordinance, upon receiving a citation for said violation, may be towed away at the owners expense at the request of the City Police Department, and the tower shall have a mechanics lien on said vehicle until the owner pays all relevant towing and storage charges. Towing may be done by City vehicles and licensed towers only. City vehicles need not be used if it would be economically more advantageous for the City to contract for said services or if City vehicles are needed for other duties or are not fully operational.

6. Termination of Emergency. The Director of Public Works is authorized to terminate a declared snow emergency provided for in §7.13 F.1., Ordinances, in less than a seventy-two (72) hour period or a snow emergency arising by operation of §7.13 F.2., Ordinances, where he is of the opinion that the declared emergency has ceased to exist in all of or in any portion or portions of the City. In the absence of the Director of Public Works, the City Engineer, or in their absence the Chief of Police may act to terminate said emergencies.

7. Exception For State Licensed Health Care Professionals. A State Licensed Health Care Professional who is providing home health care services for a patient/client prescribed by a State licensed physician may park in a prohibited area contrary to this Section for a maximum period of thirty (30) consecutive minutes, upon displaying a card in their front windshield provided by the Police Department.

8. Penalty. Any person, party, firm or corporation, who shall violate the provisions of this Ordinance, shall upon conviction thereof, forfeit \$25.00 plus the costs of prosecution, which forfeiture shall double if not paid within 120 hours of the day of violation and in default of payment of forfeiture and costs of prosecution, the violator shall be imprisoned in the County Jail for a period not to exceed three (3) days.

G. Moving Snow Onto Street Right-of-Ways. No person, party, firm or corporation shall shovel, blow, dump, plow, or otherwise place snow in any public street, highway, or alley right-of-way, including sidewalks being a part thereof, except that snow removed from a public sidewalk may be placed in the lawn park area of said right-of-way.

H. Traffic Lane Directional Signs. It shall be unlawful for a vehicle within the City to proceed straight or to turn contrary to directions stated within signs or markings while in a lane designated only for right or left hand turns.

I. Removal of Illegally Parked Vehicles.

1. Whenever any police officer or parking meter attendant has reason to believe that a motor vehicle, motor vehicle trailer, semitrailer or mobile home whether attended or unattended, standing upon a street, upon any properly posted parking lot, is in violation of any provision of the City Ordinances, or of any laws or regulations of the State of Wisconsin is blocking a drive opening, and is also creating a public nuisance by obstructing the flow of vehicular or pedestrian traffic, by obstructing snow removal operations contrary to the alternate parking Ordinance, snow emergency Ordinances, or other emergency proclamation, or by obstructing construction or maintenance work contrary to posted temporary signs, they are authorized to require the owner or operator of said vehicle, if they are within said vehicle or at the scene thereof, to move the vehicle to a position not creating a public nuisance. Where the owner cannot be located, or is not able to safely move said vehicle, the police officer or parking meter attendant may issue a parking citation and then have the vehicle moved by a City tow truck, or by a commercial towing concern to a storage lot. Nothing in this Section shall prohibit the issuance of a citation to an unlawfully parked or standing vehicle where the vehicle is not towed away. The vehicle shall not be released to the owner of said vehicle until a release from the Police Department is obtained, which release will be issued upon payment of the citation or the posting of a bond. The owner will further satisfy any mechanics lien rights which the City or the towing concern may have prior to obtaining the return of said vehicle.

2. When any motor vehicle, trailer, semitrailer or mobile home is left unattended on any public street or highway in the City of Kenosha in violation or a prohibition, limitation or restriction on parking, stopping or stand for 48 consecutive hours or more, such vehicle shall be deemed to have been abandoned

CODE OF GENERAL ORDINANCES, 2021 - KENOSHA, WISCONSIN

constituting a public nuisance which the Police Chief or his duly authorized representative is authorized to move to an authorized auto salvage yard. Any reasonable expense incurred in the removal of or in the keeping of such vehicle shall be paid by the operator or owner thereof, except in the case of a stolen vehicle, before the vehicle is released to him.

3. When any vehicle is removed pursuant to this Ordinance, the Chief of Police or his duly authorized representative shall notify the owner and/or lien holder, when known, as to the whereabouts of the vehicle.

J. Regulation of School Bus Warning Lights. Any operator of a school bus operating on streets in a residential or business district shall use flashing red warning lights when pupils, or other authorized passengers, are to be loaded or unloaded at a location where there are no traffic signals and such persons must cross the street or highway before being loaded or after being unloaded.

K. Obedience to Traffic Officers and Traffic Signs and Signals Required. No operator of a vehicle shall fail or refuse to stop for a crossing guard or school crossing guard when, in the performance of his or her duties, he or she so directs by use or sign or signal.

L. It shall be unlawful for any person to ride a motorcycle, motorbike, minibike or any motor driven vehicle upon public or private property not specifically designated for vehicular traffic, without written permission of the owner of said public or private property.

7.131 COMMERCIAL VISUAL CLEARANCE

A. Definitions.

1. "**Commercial Visual Clearance Area**" shall mean a thirty (30') foot triangular area on a lot at the intersection of two (2) streets, or a street and an alley, driveway, at the intersection of a driveway/alley and sidewalk, other point of vehicular access or railroad, two sides of which are lot lines measured from the corner intersection of the property lines to a minimum distance of thirty (30') feet from their intersection.

2. "**Visual Clearance Areas**" shall mean an open, unoccupied triangular space at the intersection of an existing or proposed street right-of-way line with another existing or proposed street right-of-way line, alley right-of-way line or a line formed by an edge of driveway; the space defined by a line joining points on such lines, the length of which is established in §2.06 of the Zoning Ordinance.

B. Regulation. Commercial trucks, buses, recreational motor vehicles, and construction-related machinery, equipment or trailers situated on commercial property shall not encroach within Commercial Visual Clearance Areas.

7.135 BICYCLE, TRICYCLE, UNICYCLE REGISTRATION

Every person, party, firm or corporation which engages in the business of selling new or used bicycles, tricycles or unicycles within the City of Kenosha shall not deliver or transfer possession of any bicycle, tricycle or unicycle to the purchaser or any other person until said bicycle, tricycle or unicycle has been registered through the Kenosha County Sheriff's Department and registration tags affixed thereto in accordance with Sheriff's Department guidelines. The seller shall complete Sheriff's Department application forms and charge a fee, determined by the Sheriff's Department, and remit both application and fee to the Sheriff's Department no less than once a week by mail or personal delivery. The failure to properly register each bicycle, tricycle or unicycle and timely remit application forms and fees shall be a separate offense.

7.14 BICYCLE, TRICYCLE, UNICYCLE, SKATEBOARD, SCOOTER AND ROLLER SKATE REGULATIONS

A. Definitions. "Bicycle" shall mean every device propelled by the feet acting upon pedals and having two (2) wheels which are not less than fourteen (14) inches in diameter. The term shall also include adult tricycles.

CODE OF GENERAL ORDINANCES, 2021 - KENOSHA, WISCONSIN

B. Wisconsin Statutes. Chapter 346, Wisconsin Statutes, as it applies to bicycles, as it now exists and as it may be amended in the future, is incorporated herein by reference.

C. Required Equipment.

1. No person may operate a bicycle upon any City street, alley, highway or public thoroughfare during the hours of darkness unless such bicycle is equipped with or the operator is wearing a lamp emitting a white light visible from a distance of at least five hundred (500) feet to the front of the bicycle. Such bicycle shall also be equipped with a red reflector or light that has a diameter of at least two (2) inches of surface area mounted and maintained so as to be visible to the rear thereof.

2. No person may operate a bicycle upon a City street, alley, highway or public thoroughfare unless all braking equipment is in good working order. No person may operate a bicycle equipped with a coaster brake unless such brake will enable the operator to make the rear wheel skid on dry, level, clean pavement.

3. No person may operate a bicycle upon a City street, alley, highway or public thoroughfare that is equipped with a siren, except in connection with a parade. The term "parade" shall mean a procession of an organized group of persons for the purpose of celebrating or promoting some event, belief or cause and having the permission of the City of Kenosha to use a street, alley, highway or public thoroughfare for such purpose. The term "**siren**" shall mean any instrument which is used for producing sound by means of air being forced over or through any mechanical device. The term "siren" shall include whistles.

D. Rules of Operation. The following rules shall apply to the operation of bicycles on all City streets, alleys, highways, public thoroughfares or bicycle lanes:

1. No person operating a bicycle shall remove both hands from the handlebars, or feet from the pedals, or practice any acrobatic or fancy riding.

2. No person operating a bicycle shall ride at an unreasonable or imprudent rate of speed under the conditions and having regard for the actual and potential hazards then existing. The speed of the bicycle shall be so controlled as may be necessary to avoid colliding with any object, person, vehicle or other conveyance on or entering the street, alley, highway, public thoroughfare or bicycle lane in compliance with legal requirements and using due care.

3. No person operating a bicycle shall ride other than upon or astride a permanent and regular seat attached to the bicycle.

4. No person operating or riding upon a bicycle shall attach himself/herself or his/her bicycle to any vehicle upon a roadway.

5. No person operating a bicycle shall ride with more people thereon than the bicycle was designed and constructed to carry.

6. No person operating a bicycle shall ride with a trailer or object in tow which was not designed and constructed for use with a bicycle, or with an appropriate trailer or object in tow which is in a state of disrepair, unsafely attached or overloaded.

7. No person operating a bicycle shall ride with any person in tow in any manner, subject to an affirmative defense that all of the following exist:

(a) The person or persons being towed are secured within a commercially available trailer subject to Section 7.14 D.6.

(b) The trailer is designed for use as a carrier of persons;

(c) The trailer is being used in accordance with the manufacturer's specifications; and,

(d) The trailer is equipped with a red reflector that has a diameter of at least two (2") inches of surface area or is a strip of reflective tape that has at least two (2) square inches of surface area, on the rear of the trailer so mounted and maintained as to be visible from all distances from fifty (50') feet to five hundred (500') feet to the rear when directly in front of lawful upper beams of headlamps on a motor vehicle.

8. No person operating an adult tricycle shall do so without a "slow vehicle" sign.

E. Child Carriers. The operator of a bicycle may attach and utilize no more than one (1) child carrier, as herein defined, to a bicycle, for each set of handlebars, for the purpose of carrying a child or children, provided that:

CODE OF GENERAL ORDINANCES, 2021 - KENOSHA, WISCONSIN

1. The operator is fourteen (14) year of age or older.
2. The child using the carrier is under the age of six (6) years.
3. The child carrier is securely fastened to the bicycle and located behind the front handlebar. The use of a child carrier contrary hereto is prohibited. The term "**child carrier**" shall mean a seat manufactured and designed expressly to be attached to a bicycle and equipped with a belt to restrain a child in the seat, two (2) arm rests, a back rest, foot rest and spoke protection and is for use by children under the age of six (6) years.

F. Operating Two (2) or More Abreast. The operation of bicycles two (2) or more abreast is prohibited on any street, alley, highway or public thoroughfare where motor vehicle traffic is permitted except:

1. Within a single lane of a street or highway on which traffic travels in the same direction on two (2) or more lanes as well as in a lane on a state highway where official signs designate the full lane may be used by bicycles.
2. On any path, trail, lane, or other way set aside for the exclusive use of bicycles.
3. In the course of permitted bicycling events, including bicycle tours and races.

G. Prohibited Places of Operation.

1. **Bicycles.** No person shall operate a bicycle within the City in any of the following areas:
 - (a) Pedestrian paths located in public parks specifically marked/designated "No Bicycles".
 - (b) Upon any private property without the express or implied permission of the owner or possessor thereof.
 - (c) Upon any property, public or private, which is posted to the effect of "No Trespassing" or "No Bicycles".
 - (d) Whenever any person is riding a bicycle upon a sidewalk, such person shall yield the right-of-way to any pedestrian and shall give an audible signal before overtaking and passing such pedestrian.
2. **Skateboards, Scooters and Roller Skates.** No person shall ride or operate a skateboard, scooter or roller skates within the City in any of the following areas:
 - (a) On any portion of any street, alley, highway or public thoroughfare intended for the use of motor vehicles, except in the crosswalk as defined by Wisconsin Statutes.
 - (b) Upon any private property without the express or implied permission of the owner or possessor thereof.
 - (c) Upon any property, private or public, which is posted "No Trespassing" or "No Skateboards/Skating".

H. Parking. The operator of a bicycle shall not park or leave a bicycle unattended in the following places and manners:

1. On any portion of any street, alley, highway or public thoroughfare intended for the operation of motor vehicles.
2. Against windows or in doorways of buildings.
3. Upon a public sidewalk, unless standing erect and not obstructing pedestrian traffic.
4. Upon the portion of any parking lot held open to the public for use by motor vehicles.
5. Upon any private property without the express or implied permission of the owner or possessor.
6. Upon any private property which is posted to the effect of "No Trespassing" or "No Bicycles".

I. Rental Bicycles/Identification Cards. Every person, party, firm or corporation which rents bicycles for use by others, shall permanently affix to each bicycle rented a tag or label stating name and address of place of rental and shall furnish to the renter an identification card which shall contain the following information:

1. Identity, address and telephone number of owner of the bicycle.
2. Serial number of the rented bicycle.

CODE OF GENERAL ORDINANCES, 2021 - KENOSHA, WISCONSIN

3. Color, make and description of the bicycle.

J. Destruction of Identification. No person shall intentionally remove, destroy, mutilate or alter the serial number on any bicycle frame or remove, destroy, mutilate or alter any valid identification or registration tag or label. Nothing herein shall prohibit the stamping or placing of numbers on bicycles for purposes of identification where such numbers are not placed over or within two (2) inches of any serial number or registration tag or label.

K. Unicycles. No person shall operate or ride any device having only one (1) wheel, irrespective of the size thereof, on any City street, alley, highway, public thoroughfare or on any sidewalk in a Business or Industrially Zoned District, except with the permission of the Police Chief, which may be granted only for parades and special events and which may be subject to a test of operating skills.

L. Conflict of Laws. If there should arise any conflict between the provisions of §7.14 and §7.01 of the Code of General Ordinances, §7.01 shall be controlling.

M. Severability. If any part of this Ordinance shall be held invalid or unconstitutional, such part shall be deemed severable and the invalidity thereof shall not affect the remaining parts of this Ordinance.

7.145 OPERATION OF BICYCLE WITHOUT OWNER'S CONSENT

A. Prohibition. It shall be unlawful for any person to operate a bicycle within the City without the owner's consent thereto irrespective of whether or not there is any intention to permanently deprive the owner of possession thereof.

B. Penalty. Any person who shall violate this Ordinance shall, upon conviction thereof, forfeit not more than Two Hundred (\$200.00) Dollars, together with costs of prosecution, and in default of payment of forfeiture and costs of prosecution, shall be imprisoned in the County Jail until said costs are paid, but not more than thirty (30) days.

7.15 IGNITION KEYS IN PARKED CARS

Ignition Keys In Parked Cars. No person, firm, or corporation shall own or possess any passenger motor vehicle unless the same is equipped with a lock suitable to lock either the starting lever, throttle, steering apparatus, gear shift lever or ignition system.

No person shall permit a passenger motor vehicle in his custody to stand or remain unattended on any street, alley or in any other public place, except an attended parking area, unless the starting lever, throttle, steering apparatus, gear shift or ignition of said vehicle is locked and the key for such lock is removed from the vehicle.

7.16 RESTRICTING HEAVY VEHICLE TRAFFIC AND PARKING

A. Established Heavy Vehicle Traffic Routes. Pursuant to §348.17 of the Wisconsin Statutes, the following streets are designed as Heavy Vehicle Traffic Routes:

Birch Road from Sheridan Road northwest to the City Limits.
Roosevelt Road from 63rd Street southwest to 39th Avenue.
Sheridan Road from the southern City Limits to the northern City Limits.
Washington Road from Sheridan Road west to the City Limits.
22nd Avenue from the southern City Limits to the northern City Limits.
30th Avenue from the southern City Limits to the northern City Limits.
39th Avenue from the southern City limits to the northern City Limits.
52nd Street from 6th Avenue west to the City Limits.
60th Street from Sheridan Road west to the City Limits
63rd Street from Sheridan Road west to 30th Avenue.
75th Street from Sheridan Road west to City Limits
80th Street from 22nd Avenue west to 39th Avenue.

CODE OF GENERAL ORDINANCES, 2021 - KENOSHA, WISCONSIN

91st Street from Sheridan Road west to 22nd Avenue.

B. Definitions.

1. "Heavy Vehicle" shall mean all Class 7 and 8 vehicles having a gross vehicle weight rating ("GVWR") of more than 26,000 pounds.
2. "Through Traffic" shall mean a Heavy Vehicle driven within the corporate limits of the City of Kenosha that does not have a point of origin or a point of destination within the City of Kenosha.

C. Regulation on Weight.

1. All Through Traffic having a GVWR in excess of 26,000 pounds shall operate only on Federal and State highways.
2. All Heavy Vehicles other than Through Traffic, having a GVWR in excess of 26,000 pounds shall use the City Heavy Vehicle Traffic Routes set forth in Section A hereof. For the purpose of making a pick up or a delivery off the City Heavy Vehicle Traffic Route, such traffic may deviate from the City Heavy Vehicle Traffic Route provided the least distance possible is traveled on roads other than City Heavy Vehicle Traffic Routes. It is the intention of this Ordinance to minimize the use by Heavy Vehicles of streets not designated Heavy Vehicle Traffic Routes.
3. The Director of Public Works may reduce the load on any of the streets on City Heavy Traffic Routes when the construction of the street or the condition thereof in his judgment warrants such action.

d. **Heavy Traffic Routes to be Marked.** Appropriate signs shall be erected to give notice of the designation of the streets listed in Subsection A as heavy traffic routes. Whenever the maximum load shall be reduced by the Director of Public Works, signs shall be erected indicating the maximum load permissible.

E. Vehicles Exempt. This Section does not apply to vehicles owned by federal or state governments, or political subdivisions thereof, when actually engaged in government functions.

F. Special and Season Weight Limitations. The Director of Public Works shall have the authority to impose special or seasonal weight limits to prevent injury to the roadway of any highway, bridge or culvert within the jurisdiction of the City of Kenosha or for the safety of users of such highway, bridge or culvert and shall be responsible for erecting signs giving notice thereof in accordance with §349.16, Wis. Stats.

7.17 RIGHT-OF-WAY WHERE YIELD SIGNS ARE INSTALLED

The operator of a vehicle, when approaching any intersection at which has been installed a yield right-of-way sign, shall yield the right-of-way to other vehicles which have entered the intersection from an intersecting highway or which are approaching so closely on the intersecting highway as to constitute a hazard of collision and, if necessary, shall reduce speed or stop in order to so yield.

Yield right-of-way signs shall be installed only at those intersections over which the City has exclusive jurisdiction except when such intersection is part of a through highway.

7.19 DUTIES OF PEDESTRIANS AND OPERATORS OF VEHICLES TO EACH OTHER

A. Prohibited Act of Pedestrians. No pedestrian shall:

1. Cross between adjacent intersections where signals are in operation or under control of traffic officer, except in marked crosswalks;
2. Cross any intersection equipped with traffic signals or under the control of a traffic officer except in the marked crosswalks;
3. Enter the roadway against a "Don't Walk" traffic signal;

CODE OF GENERAL ORDINANCES, 2021 - KENOSHA, WISCONSIN

4. Enter the roadway against a red light of a traffic signal unless it can be done safely and without interfering with traffic;
5. Enter a roadway suddenly and running or walking into the path of a vehicle which is too close to yield;
6. Walk along or upon a roadway where sidewalks are provided;
7. Walk on the right side of the roadway where no sidewalks are provided, except where it is impractical to walk on the left, facing traffic;
8. Stand in the roadway to solicit ride, employment or business;
9. Stand on or in proximity of street to solicit guarding of vehicle;
10. Disobey the signals of a police officer.

B. Vehicles to Yield Right of Way. Every operator of a vehicle shall yield the right of way to any pedestrian within a crosswalk, marked or unmarked (1) where no signals are present or operating, or (2) when signals are operating, the pedestrian has started across the street on a green light or "Walk" signal.

C. Person Working On Road. The operator of a vehicle shall yield the right of way to persons engaged in maintenance or construction work on a road whenever such operator is notified of their presence by a clear view of such persons or by flagmen or warning signs.

D. Blind Pedestrians On Road.

1. An operator of a vehicle shall stop his vehicle before approaching closer than ten (10) feet to a pedestrian carrying a cane or walking stick which is white in color or white trimmed with red and which is held in an extended or raised position and shall take such precautions as may be necessary to avoid accident or injury to such pedestrian. The fact that such blind pedestrian may be violating a rule applicable to other pedestrians does not relieve the operator of a vehicle from the duties imposed upon him by this subsection.

2. No person who is not totally or partially blind shall carry or use on any street, road or other public place any cane or walking stick which is white in color or white trimmed with red.

E. Permitting Pedestrians To Cross Certain Intersections Diagonally. Any provision of this Section (7.19) to the contrary notwithstanding, pedestrians may at intersections at which traffic control signals are in operation with a simultaneous walk sequence for all four corners, during such walk sequence, leave the crosswalk and walk diagonally by the shortest route to the opposite curb.

7.195 MOTORIZED VEHICLES PROHIBITED ON SIDEWALKS

A. Definitions.

"**Motorized Vehicles**" shall mean a vehicle which is self-propelled, used for the transportation of persons and/or property, including, but not limited to the following, irrespective of size, weight, number of wheels, whether or not having a seat: moped, motor bicycle, motorbus, motorcycle, motor home, motor truck, motor vehicle, snowmobile, all-terrain vehicle, and also means motorized skates, motorized scooter and motorized skateboards. Motorized wheelchairs and similar medical assistive devices are specifically excluded from this definition.

All other words and phrases shall be given their meaning provided in Wisconsin Statutes.

B. Prohibition. It shall be unlawful for any person to:

1. Operate a gasoline motorized vehicle on a public sidewalk, except for crossing a sidewalk to reach an area where operation is lawful. This prohibition does not apply to motorized vehicles used for construction or maintenance purposes, or used to access the site of construction or maintenance work.
2. Operate any type of motorized skates, motorized scooter, or motorized skateboard, whether gas

CODE OF GENERAL ORDINANCES, 2021 - KENOSHA, WISCONSIN

or electric powered, on a public street or highway.

7.20 TEXT MESSAGING WHILE DRIVING

A. Prohibition. No person shall drive a motor vehicle while using an electronic wireless communications device to write, send, or read a text-based communication.

B. Definition. As used in this Section, "write, send, or read a text-based communication" shall mean using an electronic wireless communications device to manually communicate with any person using a text-based communication, including, but not limited to, communications referred to as a text message, instant message, or electronic mail.

C. Exceptions.

1. Telephone Calls. For purposes of this Section, a person shall not be deemed to be writing, reading, or sending a text-based communication if the person reads, selects, or enters a telephone number or name in an electronic wireless communications device for the purpose of making or receiving a telephone call.

2. Emergency Services Professional. This Section does not apply to an emergency services professional using an electronic wireless communications device while operating an authorized emergency vehicle (as defined in Section 340.01(3), Wisconsin Statutes) in the course and scope of his/her duties.

D. Penalties. Any person who violates this Section shall, upon conviction thereof, be subject to a forfeiture of One Hundred Fifty (\$150.00) Dollars for the first violation, and One Hundred Fifty (\$150.00) Dollars for the second and all subsequent violations, together with the costs of prosecution, and in default of payment thereof, shall be committed to the County Jail for a period not to exceed ninety (90) days.

Any person who violates this Section, resulting in a traffic accident, shall, upon conviction, be subject to a forfeiture of Five Hundred (\$500.00) Dollars, together with costs of prosecution, and in default of payment thereof, shall be committed to the County Jail for a period not to exceed ninety (90) days.

7.22 CELL PHONE USE WHILE DRIVING

A. Definitions as used in this Section, the term:

1. "Electronic Sound-producing Device" means a portable media player, radio integral with a motor vehicle, or Wireless Telecommunications Device.

2. "Engage in a wireless communication" means talking; writing, sending, or reading a text-based communication, which text-based communications include, but are not limited to, text messaging, instant messaging, or emailing; or listening on a Wireless Telecommunications Device.

3. "Hands-free mode" means the use of a wireless communications device with a speaker phone, headset, or earpiece.

4. "Headphones" mean a pair of small loudspeakers with a means of holding them close to a user's ears and a means of connecting, either physically or remotely, to a signal source such as an audio amplifier, radio or compact disc player, which term headphone includes, but is not limited to, stereophones, headsets, earphones, or earbuds.

5. "Wireless Telecommunications Device" means a cellular telephone, a text-messaging device, a personal digital assistant, a stand alone computer, or any other substantially similar wireless device that is used to initiate or receive a wireless communication with another person. It does not include hearing aids, citizens band radios, citizens band radio hybrids, commercial two-way radio communication devices, subscription-based emergency communications, in-vehicle security, navigation, and remote diagnostics systems or amateur or ham radio devices.

CODE OF GENERAL ORDINANCES, 2021 - KENOSHA, WISCONSIN

B. Prohibitions

1. No person may operate a moving motor vehicle on any highway within this City while holding a wireless communications device to his or her ear while either:

- a. passing the school zones that are subject to regulation pursuant to §118.08(1) of the Wisconsin Statutes; or
- b. passing through a construction area or a utility work area that would otherwise subject the operator of a motor vehicle to increased forfeitures for excessive speeds pursuant to § 346.60(3m) of the Wisconsin Statutes, regardless of the speed at which the person was traveling.

2. No person who has an instruction permit or who has a Class D license and is under 19 years of age may operate a motor vehicle on any highway within this City while engaging in a wireless communication using a Wireless Telecommunications Device, while engaging in Internet interaction, while engaging cell-phone applications, or while engaging an Electronic Sound-producing Device through the use of two headphones covering or within both ear canals.

3. No person may operate a transit or for-hire motor vehicle on any highway within this City while engaging in a wireless communication using a Wireless Telecommunications Device, engaging in Internet interaction, or engaging cell-phone applications.

C. Exceptions

1. The prohibitions of this Subsection B shall not apply to a person who engages in a wireless communication using a Wireless Telecommunications Device:

- a. To report a traffic accident, medical emergency, or serious road hazard;
- b. To report a situation in which the person believes his or her personal safety is in jeopardy;
- c. To report or avert illegal activity; or
- d. To engage in a wireless communication while the motor vehicle is lawfully parked; or
- e. While operating an authorized emergency vehicle, or a tow truck that is responding to a disabled vehicle.

2. The prohibitions of paragraph B.1 shall not apply to a person who engages in a wireless communication using a Wireless Telecommunications Device:

- a. in hands-free mode; or
- b. to relay information that is time sensitive between a transit or for-hire operator and that operator's dispatcher, in which the device is permanently affixed to the vehicle.

D. Primary Enforcement Authorized. Upon probable cause, a law enforcement officer may stop a vehicle wherein a violation of this section has been occurring.

E. Penalties. Any person who violates this Section shall, upon conviction thereof, be subject to a forfeiture of One Hundred Fifty (\$150.00) Dollars for the first violation, and One Hundred Fifty (\$150.00) Dollars for the second and all subsequent violations, together with the costs of prosecution, surcharges, penalties, and fees and in default of payment thereof, shall be committed to the County Jail for a period not to exceed ninety (90) days. Any person who violates this Section, resulting in a traffic accident, shall, upon conviction, be subject to a forfeiture of Five Hundred (\$500.00) Dollars, together with costs of prosecution, surcharges, penalties, and fees and in default of payment thereof, shall be committed to the County Jail for a period not to exceed ninety (90) days.

7.23 AUTHORIZED EMERGENCY VEHICLES

Pursuant to the authority of §340.01(3)(e), Wisconsin Statutes, certain hereafter identified vehicles of the Kenosha Scout Leaders Rescue Squad, Inc. are designated as "Authorized Emergency Vehicles". "Authorized Emergency Vehicles" shall be approved by the Police Chief and a listing of such approved authorized emergency vehicles and a certificate of liability insurance indicating insurance coverage for

CODE OF GENERAL ORDINANCES, 2021 - KENOSHA, WISCONSIN

said vehicles in the amount of One Hundred Thousand (\$100,000) Dollars per person, Three Hundred Thousand (\$300,000) Dollars per occurrence, and Fifty Thousand (\$50,000) Dollars property damage shall be filed with the City Clerk. The City and its officers and employees shall be listed as named insurers on said insurance policy and the certificate of insurance shall so indicate. Said vehicles shall undergo a safety inspection by the Police Department prior to said vehicles being approved by the Chief of Police as "Authorized Emergency Vehicles" and said vehicles shall annually undergo a safety inspection in the month of May of each year. A copy of such safety inspections shall be filed with the City Clerk as soon as possible. Any failure to comply with the terms of this Ordinance shall be grounds for the Chief of Police or City Clerk to rescind said approval, following notice and an opportunity to be heard. Any loss of authorization shall be appealable to the Common Council following Notice of Appeal being served upon the City Clerk within ten (10) days after receipt of notice of loss of authorization.

7.24 REFERENCE TO STATUTES

Reference to specific statutory sections wherever used in this Chapter shall mean the Wisconsin Statutes of 1989-1990 and also all amendments thereof and supplementary thereto are adopted.

7.25 ENFORCEMENT

This Ordinance shall be enforced in accordance with the provisions of §§345.20 to 345.53, Chapter 299 and §66.0114 of the Wisconsin Statutes.

A. Stipulation of Guilt or No Contest. Stipulations of guilt or no contest may be made by persons arrested for violations of this Ordinance in accordance with §66.0114(1)(b), Wis. Stats., whenever the provisions of §345.27 are inapplicable to such violations. Stipulations shall conform to the form contained on the uniform traffic citation and may be accepted within 5 days of the date of the alleged violation. Stipulations may be accepted by the City of Kenosha Police Department.

B. Deposits. Any person stipulating guilt or no contest under Subsection (1) of this Section must make the deposit required under §345.26, Wis. Stats., or, if the deposit is not established under such statute, shall deposit a forfeiture penalty as provided in the schedule established by the Chief of Police and approved by the Common Council. Deposits may be brought or mailed to the office of the municipal judge, as directed by the arresting officer. Deposits for parking or nonmoving violations shall be mailed or brought to the City of Kenosha Police Department.

C. Notice of Demerit Points and Receipt. Every officer accepting a forfeiture penalty or money deposits under this Ordinance shall receipt therefor in triplicate as provided in §345.26 (3)(b), Wis. Stats. Every officer accepting a stipulation under the provisions of this Ordinance shall comply with the provisions of §§343.27, 343.28, 345.26 (1)(a) and 345.27 (2), Wis. Stats., and shall require the alleged violator to sign a statement of notice in substantially the form contained on the Uniform Traffic Citation and complaint promulgated under §345.11, Wisconsin Statutes.

7.26 PENALTIES

The penalty for violation of any provision of this Ordinance shall be forfeiture as hereinafter provided, together with the cost of prosecution imposed as provided in §345.20 to §345.53, Wisconsin Statutes.

A. Uniform Offense. Forfeitures for violation of any provision of Chapters 341 to 348, except Statutes 346.50 to 346.55, adopted by reference in §7.01 of this Chapter shall conform to forfeitures for violation of the comparable State offense, including variations or increases for second offenses.

B. Any person who shall violate any provision of this Chapter other than §§7.01 A., 7.01 B., 7.14 or 7.20 shall, upon conviction thereof, forfeit not less than One Dollar, nor more than Two Hundred Dollars, together with costs of prosecution, and in default of payment of forfeiture and costs of prosecution shall be

CODE OF GENERAL ORDINANCES, 2021 - KENOSHA, WISCONSIN

imprisoned in the County Jail until said forfeiture and costs are paid, but not exceeding ninety (90) days.

CODE OF GENERAL ORDINANCES, 2021 - KENOSHA, WISCONSIN

CHAPTER VIII STORMWATER UTILITY

8.01 GENERAL

A. Creation. There is hereby established a Stormwater Utility in the City of Kenosha, Wisconsin. The operation of the Stormwater Utility shall be managed by the Director of Public Works (the "Director"), under the direction of the Stormwater Utility Committee.

B. Authority. The City of Kenosha, acting through the Stormwater Utility, may do the following:

1. Acquire, construct, lease, own, operate, maintain, extend, expand, replace, clean, dredge, repair, manage and finance such facilities and equipment, as are deemed by the City to be proper and necessary for storm and surface water management. These facilities may include surface and underground drainage facilities, sewers, watercourse, retaining walls, ponds, streets, roads, ditches and such other natural or manmade facilities as will support a stormwater management system.

2. Undertake any operations or activities, or provide any services deemed by the City to be proper and necessary for storm and surface water management.

3. Maintain compliance with all regulatory requirements for storm and surface water management.

4. The City of Kenosha expressly reserves the right to assert all available immunities and defenses in any action seeking to impose monetary damages or equitable remedies upon the City of Kenosha, its elected officials, officers, employees and agents arising out of any alleged failure or breach of duty or relationship.

5. May establish such rates and charges as are necessary to finance planning, design, construction, maintenance and operation of the facilities in accordance with the procedures set forth in this Section.

6. May prepare an annual budget, which may include all operation and maintenance costs, debt service and other costs related to the operation of the Stormwater Utility. The costs shall be spread over the rate classifications as determined by the Common Council.

7. The City will retain any excess of revenues over expenditures in a year in a segregated Stormwater Utility Enterprise Fund, which shall be used exclusively for purposes consistent with this Section.

C. Stormwater Utility Committee. The Stormwater Utility Committee is empowered to govern, manage, control, improve and care for stormwater management services, systems and facilities.

8.02 STORMWATER UTILITY ENTERPRISE FUND

A. Creation. The City hereby establishes a Stormwater Utility Enterprise Fund in the City of Kenosha, Wisconsin's budgeting and accounting systems for the purpose of dedicating and protecting all funding applicable to the purposes and responsibilities of the Stormwater Utility, including, but not limited to, rentals, rates, charges, fees and licenses, as may be established by Resolution through the Common Council from time to time, and other funds that may be transferred or allocated to the Stormwater Utility. All revenues and receipts of the Stormwater Utility shall be placed in the Stormwater Utility Enterprise Fund, and all expenses and capital investments of the Stormwater Utility shall be paid from the Stormwater Utility Enterprise Fund.

CODE OF GENERAL ORDINANCES, 2021 - KENOSHA, WISCONSIN

B. Funding and Budget.

1. The Common Council shall place within the City of Kenosha Stormwater Utility the responsibility for operation, maintenance and regulation of the existing stormwater management services, systems and facilities previously performed, owned and operated or maintained by the City of Kenosha, and other related assets, including, but not limited to, properties, other than road right-of-ways, upon which such stormwater management systems and facilities are located, easements, rights of entry and access and certain equipment used solely for stormwater management. This responsibility shall be placed with the City of Kenosha Stormwater Utility as the Common Council has determined that the City of Kenosha Stormwater Utility has been sufficiently organized, staffed and funded adequately to carry out such responsibilities. The Stormwater Utility shall be part of the Department of Public Works.

2. The Director, or his/her designee, shall prepare an annual budget, which is to include all operation and maintenance costs, debt service and other costs related to the operation of the Stormwater Utility. The budget is subject to approval by the Common Council.

3. The costs shall be spread over the rate classifications as determined by the Common Council.

8.03 DEFINITIONS

For purposes of administering the City of Kenosha Stormwater Utility Ordinance, the following definitions shall apply to this Chapter.

A. General Definitions. Unless specifically defined, words and phrases of this Ordinance shall have their common law meaning and shall be applied in accordance with their common usage. Words used in the present tense include the future, the singular number includes the plural and the plural number includes the singular. The word "may" is permissive. The word "shall" is mandatory and is not discretionary.

B. Specific Words and Phrases.

CITY OF KENOSHA STORMWATER MANAGEMENT CRITERIA. Approved by Public Works Committee and kept on file in the office of the Director of Public Works.

CFS. Cubic Feet Per Second.

COMPLETED APPLICATION. A Stormwater Utility application for credit or adjustment that has been filed with the Director and that has all necessary information, including, but is not limited to, an executed Maintenance Agreement.

CONDOMINIUMS. The Director shall be responsible to determine the total impervious surface area of each condominium parcel based on the best available information, including, but not limited to, data supplied by the City Assessor, aerial photography, property owner, tenant or developer. The total EHU computed for the condominium parcel shall be divided equally among all condominium units.

DRIVEWAY. Private vehicular access to a parking lot or garage, whether or not it has a curb and gutter. Also, any roadway area required for vehicular circulation within a designated parking area.

EHU. An EHU is an Equivalent Hydraulic Unit, which represents a rate of water runoff, (approximately 0.35 cubic feet per second or 150 gallons per minute), from a typical residential property.

GENERAL SERVICE AREA. All land within the jurisdictional boundaries of the City of Kenosha, Wisconsin.

IMPERVIOUS SURFACE. An area that releases as runoff all or a large portion of the precipitation that falls on it, except for frozen soil. Rooftops, sidewalks, driveways, parking lots, streets, including those comprised of compacted stone or gravel, are examples of areas that typically are impervious surfaces.

INFILTRATION. Entry of precipitation or runoff into and through the substance.

CODE OF GENERAL ORDINANCES, 2021 - KENOSHA, WISCONSIN

MAINTENANCE AGREEMENT. An agreement in which the City is a party, that provides for long-term maintenance of Stormwater Management Facilities.

ON-SITE. Located within the boundaries of the legal description property.

ORDINARY HIGH WATER MARK. The point on the bank or shore up to which the presence and action of the water is so continuous as to leave a distinct mark either by erosion, destruction of terrestrial vegetation or other easily recognized characteristic.

PERVIOUS. An area that releases as runoff a small portion of the precipitation that falls on it. Lawns, gardens, parks, forests or other similar vegetated areas are examples of surfaces that typically are pervious surfaces.

PRIVATE ROADWAY. Any roadway on private property with curb, gutter and storm sewer that is not designated as a public roadway, and is not a driveway.

PROPERTY OWNER CLASSIFICATION. A classification based on the land use of a parcel. The Property Owner Classification will be either residential or other development.

OTHER DEVELOPMENT. All development other than duplex, multi-family, condominiums, all commercial and industrial development.

RATIONAL METHOD. In the rational method, peak discharge is related to rainfall intensity by the formula $Q = CiA$ in which Q is the peak discharge, in cfs; C is a non-dimensional runoff coefficient; i is the average rainfall intensity, in inches per hour (in./hr), over a duration equal to the time of concentration for the contributing area; and A is the contributing area, in acres.

RESIDENTIAL. All properties having an occupancy designated as single family, duplex or three-family dwelling units.

RIPARIAN STORMWATER SERVICE AREA. Land that drains directly into Lake Michigan without entering City conveyance system.

RUNOFF C FACTOR FLOW. A non-dimensional runoff coefficient used in the Rational Method computation.

STORMWATER CONTROL SYSTEMS. Facilities designed to control both quantity and/or quality of stormwater runoff. It may include, but is not limited to, wet detention basins, dry detention basins, and pretreatment systems.

STORMWATER DETENTION BASIN. An area designed to detain stormwater until it is released under the requirements of the City of Kenosha Stormwater Management Criteria. A Stormwater Detention Basin can be classified as "wet" or "dry".

STORMWATER DRY DETENTION BASIN. A Stormwater Detention Basin in which water drains out completely between storm events as the lowest outlet is at or below the elevation of the basin bottom.

STORMWATER MANAGEMENT FACILITIES. Facilities designed to properly manage stormwater runoff in accordance with the City's Stormwater Management Criteria, which may be updated or amended from time to time.

STORMWATER MANAGEMENT SERVICES. Tasks required to control stormwater runoff to protect the safety and welfare of the public and to comply with State and Federal regulations.

STORMWATER MANAGEMENT SYSTEMS. All public storm sewers, drainage culverts, drainage conveyances, curb and gutter, bridges or other methods used to collect, convey and/or control water quantity and water quality.

STORMWATER POLLUTION PREVENTION PLAN (SWPPP). A plan that describes a facility and the operations of the facility. The plan identifies potential stormwater pollution sources and recommends actions taken to reduce the discharge of pollutants in stormwater runoff.

STORMWATER UTILITY. A user fee based system established to fairly and equitably allocate the cost of stormwater management to customers receiving those services.

STORMWATER WET DETENTION BASIN. An area in which water remains in the pond as the lowest outlet is at an elevation above basin bottom. A Wet Detention Basin has two stages: a storage stage and a water quality stage. The storage stage is the area from the permanent water surface to the emergency overflow. The water quality stage is the area between the lowest outlet elevations to the basin

CODE OF GENERAL ORDINANCES, 2021 - KENOSHA, WISCONSIN

bottom. The water quality storage can be depleted only by infiltration and/or by evaporation from the surface.

TOTAL SUSPENDED SOLIDS (TSS). Solids that are trapped in water. TSS can include a variety of materials, including, but not limited to, silt, leaves, degrading animal and plant wastes.

WPDES PERMIT. Wisconsin Pollutant Discharge Elimination System Permit that is issued by the Wisconsin Department of Natural Resources for the discharge of pollutants.

8.04 STORM WATER UTILITY RATES AND CHARGES

A. Cost of Stormwater Management Services, Systems and Facilities. The cost of stormwater management services, systems and facilities may include operating expenses, capital investments and reserve account.

B. Funding of Stormwater Management Services, Systems and Facilities. Credits against stormwater service charges shall be allowed, provided certain conditions are met. These include:

1. On-site stormwater control systems, activities or facilities shall be constructed, operated, maintained and performed to the City of Kenosha's standards by private property owners.
2. On-site stormwater control systems, activities, or facilities shall eliminate, mitigate or compensate for the impact that the property may have upon stormwater runoff discharged to public stormwater management systems and facilities.
3. On-site stormwater control systems, activities or facilities shall improve the proper function of public stormwater management systems and facilities.

C. Calculation of Stormwater Utility Service Charge Rates.

1. Stormwater Utility Service Charge Rates. Stormwater Utility service charge rates shall be established by Resolution of the Common Council, and may be amended and reaffirmed annually by Resolution of the Common Council. In setting or modifying such rates, the Common Council shall establish rates that are fair and equitable, and reflect the value of the stormwater management services, systems and facilities to those property owners who benefit therefrom. The rates shall be sufficient to support the cost of stormwater management services, systems and facilities, including, but not limited to, the payment of principal and interest on debt obligations, lease payments, operating expenses, capital outlays, nonoperating expenses, provisions for prudent reserves and other costs as deemed appropriate by the Common Council.

2. Computation of Stormwater Utility Service Charges. The basis for computation of the charge for stormwater services to all properties within the City of Kenosha is established under this Section. The amount of charge to be imposed, the establishment of methodologies for the calculation of charges, the creation of property owner classifications for the imposition of charges, and changes in such charges, methodologies and property owner classifications may be made by further Resolution of the Common Council for the City of Kenosha. All charges established pursuant to this Section shall be fair and equitable.

3. Stormwater Utility Service Charge Policy. Stormwater Utility service charge rates shall bear a substantial relationship to the cost of providing stormwater management services, systems and facilities. Stormwater Utility service charge rates shall be coordinated with the use of other rates, charges or fees employed for stormwater management, whether within or outside the defined service areas, including plan

CODE OF GENERAL ORDINANCES, 2021 - KENOSHA, WISCONSIN

review and inspection fees, special fees for services, fees in lieu of regulatory requirements and special assessments.

4. Property Owner Classifications. The Director shall assign a property owner classification to all properties within the City of Kenosha. The property owner classifications that will be used by the Stormwater Utility will be:

- a. Residential;
- b. Other Development.

5. Determination of Stormwater Utility Service Charge. The Director shall be responsible for determining the impervious area, land area, land use or other factors as may be needed for the fair, reasonable and equitable allocation of the Stormwater Utility service charge based on the best available information, including, but not limited to, data supplied by the City Assessor, aerial photography, the property owner, tenant or developer. The billing amount shall be updated by the Director based upon any changes to the impervious area, any land divisions as approved through the Building Permit process, or any other additional information. Charges shall be reviewed on an annual basis.

6. Stormwater Utility Service Charges. Charges shall be imposed to recover all or a portion of the costs of the Stormwater Utility. Such charges, established herein, may include the following components:

a. Base Charge. A Base Charge will be imposed on all property in the City of Kenosha, regardless of size or land use. The Base Charge could include some or all administrative costs of the Stormwater Utility, and may include some or all regulatory compliance costs, and operating and maintenance costs of the Stormwater Utility that are not recovered by other means. The Base Charge is the same for each property owner.

b. EHU Charge. An EHU (Equivalent Hydrologic Unit) Charge shall be imposed on all properties in the City of Kenosha. The EHU Charge shall be based upon the estimated peak runoff using the City's standard design methodologies and design storm and/or other factors affecting the volume and rate of stormwater runoff as reasonably determined by the City. The EHU Charge is based on the number of EHUs and is calculated using the methodologies identified in **Appendix A**.

7. Stormwater Utility Service Charge Billing Period. Stormwater Utility service charges shall be billed pursuant to a schedule recommended by the General Manager of the Kenosha Water Utility and approved by the Board of Water Commissioners.

8. Payment of Stormwater Utility Service Charges. Stormwater Utility charges shall be payable twenty (20) days after the billing date, at the Kenosha Water Utility Business Office or authorized payment station. Stormwater Utility service charges shall be collected by the Kenosha Water Utility for the Stormwater Utility.

9. Penalties. A late payment charge of 1-1/2% per month, or such rate as may be established by the Kenosha Water Utility pursuant to the direction of the Wisconsin Public Service Commission, will be added to bills not paid within twenty (20) days of issuance. This late payment charge will be applied to the total balance for stormwater, including late payment charges.

8.05 STORMWATER SERVICE AREAS

The following Stormwater Service Areas shall be established to reflect significant variations in services provided to Stormwater Utility property owners.

A. Riparian Stormwater Service Area. The Riparian Stormwater Service Area shall be comprised of parcels or a portion of parcels that drain directly into Lake Michigan. The Director shall be responsible

CODE OF GENERAL ORDINANCES, 2021 - KENOSHA, WISCONSIN

for designating the properties and portion of properties in the Riparian Stormwater Service Area based upon the best available information, including data supplied by the City Assessor, aerial photography, the property owner, developer or other method as may be required. The Director shall designate said properties and provide a map of designated properties in the Department of Engineering. A parcel owner who wishes to challenge the inclusion or exclusion of a property or portion of a property in the Riparian Stormwater Service Area may file an appeal as provided in Section 8.09 of the Code of General Ordinances.

B. City of Kenosha General Service Area. The General Service Area shall be defined as all remaining parcels or a portion of parcels located within the jurisdictional boundaries of the City of Kenosha that have not been designated as parcels within the Riparian Stormwater Service Area.

8.06 EXEMPTIONS

Except as provided in this Section, no public or private property located in a service area shall receive a credit or offset against such Stormwater Utility service charges. No credit, offset or other reduction in stormwater service charges shall be granted based on the tax status, economic status, race, religion, age or sex of the owner of the property being served, or based on any other condition unrelated to the provision of stormwater management services, systems and facilities. There shall be four (4) categories of exemptions as follows:

A. Type I Exemption. The following parcels and other areas shall be automatically exempt from all Stormwater Utility Service Utility charges. Property owners do not need to apply for an exemption.

1. Railroad Tracks and Right-of-Ways. Railroad tracks and right-of-ways shall be exempt from Stormwater Utility service charges. However, railroad stations, maintenance buildings or other developed land used for railroad purposes shall not be exempt from Stormwater Utility service charges.

2. Public and Private Roadways. Public and private roadways, not including driveways, shall be exempt from stormwater service charges.

B. Type II Exemption. Parcels located in the Riparian Stormwater Service Area shall be automatically exempt from the EHU Charges. Property owners do not need to apply for an exemption.

C. Type III Exemption. The following parcel areas shall be automatically exempt from the EHU Charges.

1. Waters of the State. An area designated by the Ordinary High Water Mark of any water body wholly or partially within a parcel that can be classified as waters of the State of Wisconsin.

2. Wetlands. Areas designated on the Wisconsin Department of Natural Resources Wisconsin Wetland Inventory Map (June, 2005), herein incorporated by reference.

3. Stormwater Detention Basins. Any area set aside for the specific purpose of detaining stormwater runoff in compliance with the City of Kenosha's Stormwater Management Design Criteria.

4. Zoning and Zoning Overlay Districts. Whole or partial parcels, with a zoning designation or zoning overlay designation listed below shall be excluded from the calculation of the pervious service area to the extent that the area is part of the zoning overlay. [See City of Kenosha's Official Zoning Map on file in the Department of City Development].

- a. C-2 Lowland Conservancy
- b. FW - Floodway
- c. GFP - General Floodway

CODE OF GENERAL ORDINANCES, 2021 - KENOSHA, WISCONSIN

D. Type IV Exemption. The following parcels may be exempt from a portion of the EHU Charge. Parcel owners must first apply for a credit or adjustment pursuant to the procedures identified in **Sections 8.06** and **8.08** of this Chapter.

1. Parcels with on-site stormwater management facilities that are designed to properly manage the stormwater runoff from impervious surface areas in accordance with **Section D.4.** below, and as described by the City of Kenosha Stormwater Management Criteria may be eligible to be exempted from a portion of the EHU Charge.

2. In order to receive this credit, a current maintenance plan must be on file with the Department of Public Works, and the property owner must be in compliance with it.

3. **Stormwater Quantity Credit.** Facilities designed to meet the standards of the City of Kenosha Stormwater Management Criteria, which may be updated or amended from time to time, will be eligible for up to a four (4%) percent reduction in the EHU Charge for the property.

4. Stormwater Quality Credit.

a. Parcels with on-site stormwater management and treatment facilities that properly manage the stormwater runoff from impervious surface areas, and the stormwater quality criteria described by the City of Kenosha Stormwater Management Criteria, as may be updated or amended from time to time, may be eligible to be exempted from a portion of the EHU Charge. Parcels that have:

(1) Facilities designed to remove no less than forty (40%) percent of the average annual Total Suspended Solids from stormwater runoff from the site may be eligible for up to a ten (10%) percent reduction in the EHU Charge for the property.

(2) Facilities designed to remove no less than sixty (60%) percent of the average annual Total Suspended Solids from stormwater runoff from the site may be eligible for up to a twenty (20%) percent reduction in the EHU Charge for the property.

(3) Facilities designed to remove no less than eighty (80%) percent of the average annual Total Suspended Solids from stormwater runoff from the site will be eligible for up to a thirty (30%) percent reduction of the EHU Charge for the property.

b. Parcels that have obtained an individual WPDES Permit from the Wisconsin Department of Natural Resources (WDNR) and meet the requirements of the permit may be eligible for up to a ten (10%) percent reduction in the EHU charge for the property. A current permit and Stormwater Pollution Prevention Plan must be on file with the Department of Stormwater Utility.

5. **Shared Stormwater Management Facilities.** Groups of Single Family or Other Developed property owners which are part of a common development plan which includes within the development, privately owned, maintained or operated stormwater control systems, facilities, assets, services or activities that reduce the City of Kenosha Stormwater Utility's cost of providing stormwater management services, systems and facilities, may receive a credit based upon attaining and continuing compliance with the technical requirements and performance standards referenced in **Section 8.06 D.3.**, and **D.4.**, above. Such credits shall be applied to all properties using and contributing to the cost of ownership, operation and maintenance of such stormwater management systems.

8.07 PROCEDURE FOR APPLYING FOR ADJUSTMENTS TO SERVICE CHARGES

A. Adjustment to EHU. Any property owner may apply for an adjustment to the EHUs assigned to the owner's property if the property owner believes the measurements on which the EHU calculation is based are inaccurate.

B. Procedure To Apply For Adjustments.

1. Any property owner or agent may submit a request for an adjustment at any time. All such requests shall be submitted to the Director on forms provided by the City, together with an application fee.

CODE OF GENERAL ORDINANCES, 2021 - KENOSHA, WISCONSIN

2. The Director may require the property owner, at property owner's expense, to provide supplemental information.
3. Once a completed request and all required information is fully submitted, the Director shall have thirty (30) calendar days within which to render a written decision. The Director shall notify the requesting owner in writing of the decision by first class mail addressed to the individual at the address listed within the request. If the request is denied, the Director shall include the grounds for the denial.
4. If a request is granted, Stormwater Utility service charges shall be adjusted on a prospective basis.
5. The application fee schedule will be established by Resolution of the Common Council.

8.08 PROCEDURE FOR APPLYING FOR CREDIT TO STORMWATER UTILITY SERVICE CHARGE

A. Technical and Procedural Criteria. The Director shall establish specified technical and procedural criteria by which credits will be granted. Copies of such technical and procedural criteria will be maintained by and be available from the Department of Public Works.

1. In order to obtain a credit, the property owner must make application to the Director on forms provided by the Director for such purpose.
2. Property owners must apply for any applicable credits.
3. The application for any credit must be in writing and must include the information necessary to establish eligibility for the credit, accompanied by any application fee, and be in the format established by the Director. Incomplete applications will not be accepted by the Director.

B. Granting of Credits. When an application for a credit is deemed complete by the Director, the Director shall have thirty (30) days from the date that the complete application is accepted to:

1. Grant the credit in whole;
2. Grant the credit in part; or,
3. Deny the credit.

Credits applied for and granted in whole or in part, shall apply from the first day of the calendar month immediately following the date on which a complete application for the credit has been filed with the City of Kenosha. The applicants may appeal such determination pursuant to **Section 8.09** of the Code of General Ordinances.

C. Annual Review of Credit. The Director shall review the credit and the basis therefor each year, and may terminate the credit if grounds are found. If such credit is terminated, the property owner will be notified in writing of the grounds for denial by first class mail, and may appeal such determination pursuant to Section 8.09 of this Chapter; or, may, if possible, correct the deficiencies that caused the termination and reapply for the credit.

8.09 APPEALS PROCESS

A. Within thirty (30) calendar days after the date of mailing the Director's decision, the property owner may appeal the Director's decision to the Stormwater Utility Committee by filing a written appeal, together with an application fee, with the City Clerk/Treasurer. The written appeal shall specify all grounds for the challenge and state the amount of stormwater charge that the appellant considers to be appropriate. The appeal must specifically address the Director's conclusions and not merely repeat the basis for the initial request. Failure to timely and properly appeal shall deprive the Stormwater Utility Committee of

CODE OF GENERAL ORDINANCES, 2021 - KENOSHA, WISCONSIN

jurisdiction to hear the appeal. The Application Fee Schedule shall be established by Resolution of the Common Council.

B. The Stormwater Utility Committee shall conduct a formal hearing at such time and place as designated in a hearing notice to the appellant, providing a minimum of five (5) business days notice to the appellant. In considering an appeal, the Stormwater Utility Committee shall determine whether the Stormwater Utility service charge is fair based upon the evidence presented at the hearing. The Stormwater Utility Committee shall notify the appellant in writing of its determination by first class mail addressed to the individual at the address listed within the appeal. Service is conclusive upon mailing.

C. Within thirty (30) calendar days after the date of mailing of the Stormwater Utility Committee's decision, the property owner may appeal the Committee's decision to the Common Council following the process set forth in this Section. Such appeal must specifically address the Stormwater Utility Committee's conclusion and not merely repeat the basis for the initial request.

D. The Common Council shall consider the appeal in the same manner as a new Resolution, pursuant to its rules for procedure in existence at the time of consideration. The City Clerk/Treasurer shall provide written notice no later than five (5) business days to the address listed within the appeal of the time and place of the Common Council's consideration of the appeal. In considering an appeal, the Common Council shall determine whether the stormwater charge is fair and equitable. The Common Council shall base its decision upon the information presented at its meeting. The City Clerk/Treasurer shall notify the appellant in writing of the Common Council's determination by first class mail addressed to the individual at the address listed within the appeal. Service is conclusive upon mailing.

E. As a condition precedent to any adjustment or credit request, or any appeal, a property owner must have paid in full all Stormwater Utility service charges to the City.

F. If an adjustment request is granted, Stormwater Utility service charges shall be adjusted on a prospective basis, and the application fees shall be refunded.

8.10 PAYMENTS

A. Stormwater Utility Charges. Stormwater Utility charges will be billed as a line item on the City of Kenosha Water Utility bill to the utility property owner and shall be payable at the same time and in the same manner as Water Utility charges. A stormwater utility bill will be established for those properties that do not receive a Water Utility bill.

B. Property Owner Responsibility. The property owner shall be responsible for all Stormwater Utility charges.

C. Delinquent Payments. Delinquent stormwater charges may be placed as a lien upon the property as provided in Sections 66.0821(4)(d) and 66.0809, Wisconsin Statutes.

D. Tenant Payments. The owner of any property which is occupied by tenants shall have the right to examine, during normal business hours, the appropriate records of the City to determine whether such fees and charges have been paid by such tenants.

E. Parcel Number Changes. When properties are divided, or when two (2) or more contiguous properties with separate parcel numbers are combined, new parcel number(s) are assigned to the new lot(s) and the previous parcel number is deleted. Prior to the issuance of any new parcel number, all unpaid Stormwater Utility charges, whether delinquent or not, shall be paid before the change in parcel status is executed.

CODE OF GENERAL ORDINANCES, 2021 - KENOSHA, WISCONSIN

F. Alternative Method To Collect Stormwater Charges. In addition to any other method for collection of the charges established under this Section, or subsequent Resolution, such charges may be and are hereby authorized to be levied and imposed as a special charge pursuant to Section 66.0627, Wisconsin Statutes. The mailing of the bill for Stormwater Utility service charges to a property owner shall serve as notice to the property owner that failure to pay the charges when due may result in the charges being imposed pursuant to the authority of Section 66.0627, Wisconsin Statutes. The procedures contained in Section 66.0627, Wisconsin Statutes, shall govern such notice and further collection procedures.

8.11 SEVERABILITY

Should any section, paragraph, sentence, clause or phrase of this Section be declared unconstitutional or invalid, or be repealed, it shall not affect the validity of this Ordinance as a whole or any part thereof other than the part so declared to be invalid or repealed.

**APPENDIX A
CALCULATION OF
STORMWATER UTILITY CHARGES
CHARGES**

1. Base Charges. The Base Charge shall be a uniform charge on each bill. The Base Charge shall be established by dividing the total value of the base services determined by the City of Kenosha by the total number of property owners.

2. EHU Charges.

- a. The basis of the Stormwater Utility Service Charge shall be the Equivalent Hydrologic Unit (EHU).
- b. The estimated number of EHUs shall be based on either the average peak runoff rate for a property owner classification, or the estimated peak runoff for the individual parcel, as described herein.
- c. The EHU Charge shall be established by dividing the total number of EHUs estimated to be within the City of Kenosha by the cost of the stormwater services not included in the base charge.

3. Calculation of EHU. The Director shall be responsible for determining the impervious area and other required information necessary to compute the EHU for each property in the City of Kenosha based on the best available information, including, but not limited to, data supplied by the City Assessor, aerial photography, the property owner, developer or other method as may be required.

a. Rational Method To Estimate Peak Runoff Rates. The Rational Method described in the City of Kenosha Stormwater Management Criteria shall be used to estimate peak runoff rates. That methodology assumes:

(1) Runoff C Factor. The Runoff C Factor for all impervious surface areas shall be assumed to be 0.95 and 0.2 for all pervious surface areas.

(2) Time of Concentration - Residential Property Owners. The Time of Concentration for all residential property owners shall be assumed to be fifteen (15) minutes.

(3) Time of Concentration - Other Developed Property Owners/Impervious Surface Areas. The Time of Concentration for all impervious surface areas for all Other Developed Property Owners shall assume to be five (5) minutes.

(4) Time of Concentration - Other Developed Property Owners/Pervious Surface Areas. The Time of Concentration for all pervious surface areas for all Other Developed Property owners shall assume a time of concentration based upon the total pervious surface areas.

b. Average Peak Runoff Rate. The EHU shall be based on the average peak runoff rate computed for typical residential property. The average peak runoff rate for a typical residential EHU has been estimated to be 0.35 cfs.

(1) Residential Property Owners. Residential property owners shall be further grouped by the Director into one of four subclassifications. Each subclassification shall be charged a uniform number of EHUs based on the average peak runoff rate for that subclassification, computed as follows:

(a) Small Residential with an estimated peak runoff rate of less than 0.30 cfs shall be charged at a rate equal to 0.7 EHUs.

(b) Typical Residential with an estimated peak runoff rate greater than or equal to 0.30 cubic feet per second (cfs) and less than or equal to 0.41 cfs shall be charged at a rate equal to 1.0 EHU.

(c) Large Residential with an estimated peak runoff rate greater than 0.41 cfs and less than or equal to 0.59 cfs shall be charged at a rate equal to 1.4 EHU.

CODE OF GENERAL ORDINANCES, 2021 - KENOSHA, WISCONSIN

(d) **Very Large Residential** with an estimated peak runoff rate greater than 0.59 cfs shall be charged at a rate equal to 2.4 EHU.

c. Other Development.

(1) **Other Development** shall be subject to a charge based upon the sum of EHUs computed for impervious surface and pervious surface areas.

(a) **Impervious Surface Area EHUs** shall be determined by dividing the total impervious surface area by the equivalent impervious surface area of 2,477 square feet, that has been estimated to generate 0.35 cfs.

(b) **Pervious Surface Area EHUs** shall be determined by dividing the total pervious surface area by the equivalent pervious surface area that would be estimated to 0.35 cfs. The equivalent pervious surface area increases with increasing time of concentrations according to the Table below.

(2) Responsibility For EHU.

(a) **EHU for Other Development other than condominiums** shall be the EHU determined in c.(1), above.

(b) **EHU for Other Development which consists of condominiums** shall be the proportionate share of the EHU determined in c.(1) above, that the condominium unit has with respect to the total number of the other condominium units that are on the real property lot.

Parcel Pervious Surface Area Less Than or Equal To (ac)	Assumed Time of Concentration (min)	Equivalent Pervious Surface Area = 0.35 cfs (sq. ft.)
0.1	5	11,764
0.5	10	14,947
1.2	15	17,811
4.6	30	26,286
18.6	60	41,429
74.4	120	68,368
167.4	180	95,288
669.4	360	163,935
2,677.7	720	288,568
10,710.7	1,440	505,392
42,843.0	2,880	871,200
96,396.7	4,320	1,306,800
290,547.5	7,500	1,890,000

CODE OF GENERAL ORDINANCES, 2021 - KENOSHA, WISCONSIN

CHAPTER IX BUILDING CODE

- 9.01 Title
- 9.02 Definitions
- 9.03 General
- 9.04 Powers and Duties of Code Official
- 9.05 Permit Application
- 9.06 Permit
- 9.07 Fees
- 9.08 Enforcement Procedure
- 9.09 Certificate of Occupancy
- 9.10 One and Two Family Dwellings
- 9.105 Windows in Hotel Bedrooms
- 9.11 Unsafe Buildings
- 9.12 Existing Buildings
- 9.13 Temporary Buildings and Uses
- 9.14 Street Occupancy For Dumpsters
- 9.15 Vacant Buildings
- 9.16 Moving of Buildings
- 9.17 Razing of Buildings
- 9.18 Swimming Pools; Hot Tubs; Spas
- 9.19 Plumbing Qualifications
- 9.20 Electrical
- 9.21 HVAC
- 9.22 Air Conditioning Equipment on Single, Two Family and Multi-Family Residential Buildings
- 9.23 Street Numbering
- 9.24 Sidewalk; Curb and Gutter; Driveway Approaches; Driveway Aprons
- 9.25 Downspout Discharge
- 9.26 Retaining Walls
- 9.27 Excavations; Depressions; Pits
- 9.28 Structural Interference With Public Safety Radio Communication
- 9.29 Appeals
- 9.30 Violations; Penalties

9.01 TITLE

This Chapter shall be known as the "Building Code" of the City of Kenosha, Wisconsin, and is referred to herein as the Code.

9.02 DEFINITIONS

A. General. The following terms and phrases shall have the meanings provided herein:

Addition. New construction performed on a Building which increases the outside dimension of the Building.

Alteration; Alter; Altered. Substantial modification other than an Addition, Minor Repair or maintenance to a Building or to systems within a Building.

CODE OF GENERAL ORDINANCES, 2021 - KENOSHA, WISCONSIN

Accessory Building. A detached Building in any zoning district not used as a Dwelling Unit, but having a use which is incidental to that of the main Building, and which is located on the same lot.

Accessory Building includes, but is not limited to, garages, tool sheds, and gazebos.

Building. Any structure used or intended for supporting or sheltering any use or Occupancy.

City. The City of Kenosha, Wisconsin.

Code Official. The Director of City Inspections and any duly authorized designee of the Director.

Department. The Department of City Inspections.

Driveway Approach. An area within a public right-of-way which is improved for motor vehicle traffic and which connects a private road or driveway to a portion of a public right-of-way which is improved for motor vehicle traffic.

Driveway Apron. The paved surface located on private property a minimum of nine (9') feet in width which extends from the street right-of-way to the principal Building or Accessory Building or its termination whose intended use is the ingress and egress of the property with motor driven vehicles. The width of the Driveway Apron shall not exceed the width of the Driveway Approach at the property line.

Dwelling. Any Building which contains one (1) or two (2) Dwelling Units.

Dwelling Unit. Two (2) or more rooms in a residence designed for, and Occupied by, not more than one (1) family for living and sleeping purposes and containing only one kitchen.

Manufactured/Mobile Home. A Manufactured Home which was originally constructed, designed to be transported by any motor vehicle upon a public highway, and designed, equipped and used primarily for sleeping, eating and living quarters, or is intended to be so used; and includes an Addition, attachments, annexes, foundations and appurtenances that equal or exceed fifty (50%) percent of the assessable value of the Manufactured Home.

Minor Repair. Repair performed for maintenance or replacement purposes on any existing Building which does not affect room wall arrangement, light and ventilation, access to or efficiency of any existing stairways, exits, fire protection or aesthetic appearance, and which does not increase or Alter a given Occupancy or use.

Occupancy. The use of a Building or structure for its intended purpose.

Occupied. A Building is considered to be Occupied when it is open to the public, when a business or manufacturing activity is performed therein, when people reside therein, or when any personal property is moved therein.

Permit. Any Permit, however designated, issued by the Department of City Inspections under authority of this Code.

Permittee. A person who holds a Permit under this Code.

Person. Any natural Person, firm, partnership, corporation or legal entity.

Plan. A Building or site improvement Plan and required documents.

Premises. The site of a Dwelling, multi-family Dwelling, Public Building or place of employment.

Public Building. Any Building or structure not a Dwelling or Accessory Building. **Work.**

Any activity on a Building or Premises which requires a Permit under this Code. **Work Site.** The site where Work is being performed.

B. Other Definitions. Terms and phrases not defined herein, but defined in the Wisconsin Commercial Building Code shall have the definitions contained therein.

9.03 GENERAL

A. Scope. This Code applies to all Dwellings, Public Buildings, places of employment and Accessory Buildings.

B. Intent and Purpose. The intent and purpose of this Code is to:

CODE OF GENERAL ORDINANCES, 2021 - KENOSHA, WISCONSIN

1. Protect the health, safety and welfare of the public and employees by establishing minimum standards for the design, construction, maintenance and inspection of Dwellings, multi-family Dwellings, Public Buildings, places of employment, and Accessory Buildings.
2. Provide Plan review and on-site inspections for Dwellings, multi-family Dwellings, Public Buildings, places of employment, and Accessory Buildings by inspectors certified by the Wisconsin Department of Safety and Professional Services.
3. Establish and collect fees to defray administrative and enforcement costs.
4. Establish remedies and penalties for violations.

C. Adoption of Codes. The following Wisconsin Administrative Codes and National Codes, including all referenced codes, statutes, and standards, and future amendments thereto, are incorporated by reference as if fully set forth herein, copies thereof being on file in the Department of City Inspections:

SPS 302	Fee Schedule
SPS 305	Licenses, Certifications And Registrations
SPS 316	Electrical
SPS 318	Elevators, Escalators, And Lift Devices
SPS 320-325	Uniform Dwelling Code And Appendices
SPS 326	Manufactured Home Communities
SPS 328	Smoke Detectors And Carbon Monoxide Detectors
SPS 340	Gas Systems
SPS 341	Boilers And Pressure Vessels
SPS 345	Mechanical Refrigeration
SPS 361-366	Commercial Building Code And Appendices
SPS 367	Rental Unit Energy Efficiency
SPS 371	Solar Energy Systems
SPS 375-379	Buildings Constructed Prior To 1914
SPS 380-387	Plumbing And Appendices
SPS 390	Design And Construction Of Public Swimming Pools And Water Attractions
SPS 500	Small Business Enforcement Discretion
PSC 114	Wisconsin State Electrical Code, Volume I
NFPA70, NEC National Electric Code	

D. Change In Use or Occupancy. When the use of a Building is changed and the Code requirements for the new use are more stringent than those for the previous use, then such Building shall be made to comply with the requirements for the new use, as provided in this Code.

If upon inspection of a Building it is found that its use has changed since the effective date of the Building Code it was constructed under, and that it does not comply with the requirements of the Building Code in effect at the time of any such change of use, the Building shall then be made to comply with the requirements of the Building Code in effect at the time of such change of use.

E. Limitations. Approval of an application or Plan by the Department shall not be construed as an assumption of any responsibility on the part of the Department for the design or construction of the Building. The City, by approval of an application or Plan, does not assume liability for death, injuries sustained or property damage arising out of any defect in any Building, equipment, construction or installation.

F. Severability. If any section, clause, provision or portion of this Code or the Wisconsin Administrative Codes, or any other State law, rule or regulation herein incorporated is adjudged

CODE OF GENERAL ORDINANCES, 2021 - KENOSHA, WISCONSIN

unconstitutional or invalid by a Court of competent jurisdiction, the remaining provisions shall remain in full force and effect.

9.04 POWERS AND DUTIES OF CODE OFFICIAL

A. Code Official. During the course of his/her employment with the City, the Code Official shall not be employed by any contractor engaged in the construction, repair, remodeling, renovation or demolition of any Building in the City.

B. Duties. The Code Official shall administer and enforce all provisions of this Code, the Wisconsin Administrative Code, Department of Safety and Professional Services rules and regulations, and all other State and local laws, rules and regulations regarding Buildings and places of employment with the assistance of authorized certified agents.

The Code Official shall have the authority to render interpretations of this Code and to adopt policies and procedures in order to clarify the application of its provisions. Such interpretations, policies and procedures shall be in compliance with the intent and purpose of this Code.

C. Right of Entry. Where it is necessary to make an inspection to enforce the provisions of this Code, or where the Code Official has reasonable cause to believe that there exists in a Building or on a Premises a condition which is contrary to or in violation of this Code which makes the Building or Premises unsafe, dangerous or hazardous, the Code Official is authorized to enter the Building or Premises at reasonable times to conduct inspections and perform the duties imposed by this Code, provided that if the Building is Occupied, that credentials be presented to the owner, owner's agent or contractor, and entry requested. If the Building or Premises is unoccupied, the Code Official shall first make a reasonable effort to locate the owner, owner's agent or contractor, and request entry. If entry is refused, the Code Official shall have recourse to the remedies provided by law to secure entry.

D. Records. The Code Official shall perform all administrative tasks required by City or State laws, rules and regulations. The Code Official shall keep a record of all Plans reviewed, Permits issued, fees collected, inspection reports, notices and orders issued. Each Permit shall be consecutively numbered in the order of its issuance.

E. Evidence of Compliance. Wherever it is deemed that there is insufficient evidence of compliance with the provisions of this Code, or evidence that a material or method does not conform to this Code, or in order to substantiate claims for alternative materials or methods to obtain Code compliance, the Code Official is authorized to request that tests be conducted through a recognized testing agency, or that designs or materials be reviewed and approved by licensed design professionals at the cost of the applicant. Such tests and approvals are subject to final approval and acceptance by the Code Official.

9.05 PERMIT APPLICATION

A. Application. To obtain a Permit under this Code, the owner, owner's agent or contractor shall first file an application in writing on form(s) furnished by the Department. The application shall include:

1. The address of the Premises.
2. The name, address and phone number of the owner.
3. The name, address and phone number of the contractor.
4. The license number of the contractor.
5. The estimated construction cost of the Building.

CODE OF GENERAL ORDINANCES, 2021 - KENOSHA, WISCONSIN

6. Any other data or information requested on the application.
7. Plans and other construction documents as indicated in Section 9.05 B.
8. The signature of the owner, owner's agent or contractor.

B. Submission of Plans. Plans shall be submitted in duplicate with each application for a Permit. All Plans shall be drawn to scale. In addition to customary calculations and specifications, each Plan shall include:

1. The location of any streets, alleys and lot lines.
2. Any other Buildings on the property.
3. Intended use of all rooms.
4. Floor area of all rooms.
5. Window and door sizes.

C. Surveys. Applications submitted for a Permit to construct new Buildings, Additions or Accessory Buildings shall be accompanied by a survey prepared and certified by a registered land surveyor. The Code Official may waive this requirement when property lines and Building location can be verified without a survey.

D. Plans. Where required, the Plans shall be prepared and wet-stamped by a State licensed architect or design professional. Where special or unusual conditions exist, the Code Official is authorized to require additional construction documents to be prepared by a licensed architect or design professional.

E. Issuance of Permits. If after reviewing Permit applications and Plans, the Code Official finds that all proposed Work complies with all City and State laws, rules and regulations, the Code Official shall approve said Plans and applications, conditioned upon any corrections or modifications required, assign appropriate fees, and issue the Permit upon payment of required fees.

F. Validity of Permit. The issuance or granting of a Permit shall not be construed as an approval of any violation of any of the provisions of this Code or of any other State or local laws, rules and regulations. Permits which authorize the violation or cancellation of the provisions of this Code or other State or local laws, rules and regulations shall not be valid. The issuance of a Permit and Plan approval shall not prevent the Code Official from requiring the correction of errors in Plans.

G. Revocation of Approval. The Code Official may revoke any approval of Permits and/or Plans issued under this Code based upon false statements or misrepresentation of facts on which the approval was based, or for material and substantial errors in Plans.

9.06 PERMIT

A. Permit Required. Any owner, authorized agent or contractor who intends to construct, enlarge, Alter, repair, renovate, move, demolish, or change the Occupancy of a Building, or to erect, install, enlarge, repair, renovate, remove, convert or replace any electrical, gas, mechanical or plumbing system, which is regulated by this Code, or to cause any such Work to be done, shall make application to the Code Official and obtain the required Permit prior to commencing any Work.

B. Display of Permit. Once a Permit is issued, a copy of the Permit shall be posted in a conspicuous area located on the Building or Premises.

C. Commencement of Construction. The Permit shall become null and void unless construction has commenced within sixty (60) days of the date of Permit issuance, or the Permit or the Work

CODE OF GENERAL ORDINANCES, 2021 - KENOSHA, WISCONSIN

authorized by the Permit is suspended for a period of sixty (60) days anytime after the Work has commenced.

D. Permit Fee Refund. Fees paid for Permits under this Code which, through the error of the applicant, are issued for the wrong Work or wrong Premises, or for any Work which was not commenced, shall be subject to a refund upon written request to the Department, providing that the refund request is received within one (1) year of the original date of issuance of the Permit, and providing that a processing fee of the lesser of Twenty (\$20.00) Dollars or the cost of the Permit shall be first deducted by the Department.

E. Unpaid Permit Fees. If Permit fees remain unpaid after the Department issues a second notice of Permit approval and Permit fees due, the unpaid Permit fees together with a One Hundred (\$100.00) Dollar administrative fee shall be assessed as a special charge against the Premises to which the Permit applies, shall accrue interest at the rate established in Section 2.10 of the Code of General Ordinances, and shall be a lien against the Premises until paid in full. The administrative fee is to cover the administrative costs of assessing the special charge against the Premises.

F. Completion of Construction. All Work authorized by a Permit shall be completed in accordance with this Code and all applicable State and local laws, rules and regulations within the following specified time period(s):

New One and Two Family and Multi-Family Dwelling.....	1 Year
Residential Addition/Alteration.....	6 Months
New Public Buildings/Additions to Public Building.....	2 Years
Electric/Plumbing/HVAC.....	6 Months
Accessory Building.....	6 Months

G. Extensions of Time To Complete Work. Any applicant who obtains a Permit and fails to complete the Work in the time specified in Section 9.06 F., may apply to the Code Official for a time extension not to exceed one (1) year. Extensions may be granted if the Work commenced has proceeded in a professional and workmanlike manner which exhibits reasonable progress. Extended Permits shall not impose new conditions unless required by this Code or any other State or local law, rule or regulation. Upon a violation of Section 9.06 F., no new Work may proceed without the issuance of an approved extension or a new Permit.

H. Exemptions From Permit. Exemptions from Permit requirements of this Code, below stated, shall not be deemed to grant authorization for any Work to be done in any manner in violation of the provisions of this Code or any other State or local laws, rules and regulations. Permits shall not be required for the following:

1. Building.

- a.** In residential uses, one (1) story Accessory Buildings used as tool or storage sheds, playhouses and similar uses, having a floor area of one hundred twenty (120) square feet or less. Permits are required for any Accessory Building of any size in any other zoning district.
- b.** Retaining walls which are five (5') feet in height or less, measured from the top of the footing to the top of the wall.
- c.** Painting, papering, tiling, carpeting, cabinets, countertops and similar finish work, siding, window or door replacement or reshingling.

CODE OF GENERAL ORDINANCES, 2021 - KENOSHA, WISCONSIN

2. Electrical.

- a. .Minor Repairs and maintenance Work, including the replacement of lamps or the connection of approved portable electrical equipment to approved permanently installed receptacles.
- b. Temporary testing systems required for the testing or servicing of electrical equipment or apparatus.

3. Mechanical.

- a. Portable heating appliance.
- b. Portable ventilation equipment.
- c. Portable cooling unit.
- d. Replacement of any minor part that does not Alter the approval of equipment or make it unsafe.

4. Plumbing.

The stopping of leaks in drain, water, soil, waste or vent pipes, provided that if any concealed trap, drainpipe, water, soil, waste or vent pipe becomes defective and it becomes necessary to remove and replace the same with new material, such Work shall be considered as new Work and a Permit shall be obtained.

The clearing of stoppages or the repairing of leaks in pipes, valves or fixtures, and the removal and reinstallation of water closets, providing such repairs do not involve the replacement or rearrangement of valves, pipes or fixtures.

I. Site Safety Requirements. As a condition of approval of any Permit, the Code Official may deem it necessary for the applicant to provide site safety and security measures as described herein due to the close proximity of the construction site to residential property or other conditions impacting site safety or security.

1. Fencing. The applicant shall install a six (6') foot high chainlink fence, including gates and access to the site, around the perimeter of the construction site in a manner approved by the Code Official. Required fencing shall be installed prior to the commencement of any other Work on the site.

2. Guarding Site. The applicant shall take or cause to be taken all steps necessary to properly guard the Work and the site around the Work, to protect the public from damage of or injury to property or persons.

3. Other Conditions. The Code Official may impose additional means of site safety and security measures as deemed necessary by circumstances which are unique to any Work.

J. No Delinquent Special Assessments, Special Charges, or Special Taxes. The issuance of Permits under this Code shall be conditioned upon there being no delinquent special assessments, special charges, or special taxes with respect to the real property upon which the Work will be performed. If in the opinion of the Director of the Department of City Inspections, the Permit is required to resolve a condition of imminent danger to public health, safety and welfare, the Director may waive this condition of issuance. If there is a waiver of the conditions of issuance, the Director of the Department of City Inspections shall notify the Committee of Public Safety and Welfare within 30 days of the waiver.

9.07 FEES

A. Fees. The Common Council shall, from time to time, by Resolution, establish fees for the following Permits, reviews, inspections and services provided by the Department of City Inspections.

Accessory Building

CODE OF GENERAL ORDINANCES, 2021 - KENOSHA, WISCONSIN

Commercial Building, Addition and Alteration
Electrical
Fences
Heating, Ventilating and Air Conditioning
Moving of Buildings
Occupancy
Penalty
Plan Reviews
Plumbing
Razings
Reinspection
Residential Building, Addition and Alteration
Retaining Walls
Signs
Street Occupancy
Swimming Pools and Hot Tubs

B. Payment of Fees. A Permit shall not be valid until such time that the fees required by this Code have been paid. The fee paid for a Permit that was not granted or was not issued will not be refunded.

C. Work Started Without Permit. When a Permit is required by this Code and Work is started prior to obtaining a Permit, the fees required shall be trebled. For the second offense within a twelve (12) month period, starting Work prior to obtaining a Permit, the fees shall be quintupled. For the third such offense within a twelve (12) month period, in addition to the penalties listed above, the Code Official may bar such contractor from Work in the City for a period of one (1) year from the completion date of the Work which resulted in the third offense. The payment of the trebled or quintupled fee shall not relieve any Person from complying with the requirements of this Code, nor from any penalties provided herein. Notwithstanding the other provisions of this Subsection C, if prior to being contacted by an employee of the City regarding the Work, the owner of the Premises self-reports to the Department the violation of this Code for starting the Work without a Permit, the owner is absolved of the increased fees required in this Subsection C for that Work; nothing in this sentence relieves the owner from complying with the requirements of this Code, including the payment of fees established in Subsection A.

D. Permit Fee Waiver For a Porch or Deck. A Permit fee waiver for a porch or deck may be granted to a property owner who has received an Order To Repair from the Department as a result of a Neighborhood Inspection Program provided the value of the repairs is less than Two Hundred (\$200.00) Dollars.

E. Impact Fees. The issuance of a Permit shall be conditioned upon the developer paying Impact Fees imposed in accordance with **Chapter 35** of the Code of General Ordinances.

F. Reinspection Fees. A Reinspection Fee may be assessed when any of the following occur:

1. An inspection is requested by the owner, owner's agent or contractor, and the Work is not completed.
2. An inspection is requested by the owner, owner's agent or contractor, and there is no access to the Premises.
3. After an initial inspection and notice of violation(s) to be corrected, an inspection is requested by the owner, owner's agent or contractor to approve corrections, and those corrections are incomplete, only a portion of the corrections have been made, the corrections have been ignored, or previous

CODE OF GENERAL ORDINANCES, 2021 - KENOSHA, WISCONSIN

arrangements have not been made with the Code Official to accomplish ordered corrections in phases, a Reinspection Fee shall be imposed on the owner, owner's agent or contractor responsible for the inspection request.

Work may not proceed on the installation impacted until the Reinspection Fee has been paid.

There shall be no Reinspection Fee for a final inspection to determine compliance, or for a reinspection occurring during a period of an approved time extension granted for good cause and involving a good faith effort on the part of the property owner.

A Reinspection Fee of Ninety (\$90.00) Dollars may be charged for a second reinspection; a Reinspection Fee of One Hundred Eighty (\$180.00) Dollars may be charged for a third reinspection; and, a Reinspection Fee of Three Hundred Sixty (\$360.00) Dollars may be charged for each subsequent reinspection. If Reinspection Fees are not paid within thirty (30) days of mailing of an invoice to the Permittee, the unpaid Reinspection Fees together with a One Hundred (\$100.00) Dollar administrative fee shall be assessed as a special charge against the Premises to which the Reinspection Fees apply, shall accrue interest at the rate established in Section 2.10 of the Code of General Ordinances, and shall be a lien against the Premises until paid in full. The administrative fee is to cover the administrative costs of assessing the special charge against the Premises.

9.08 ENFORCEMENT PROCEDURE

A. Inspections. No structural portion of any part of any Building, and no reinforcing steel, or structural framework of wood, steel, iron, concrete, nor any electrical, plumbing, heating, ventilating or air conditioning installations shall be concealed without first obtaining proper inspection and approval.

B. Required Inspections. Required inspections are as follows:

1. Sewer and water connection(s).
2. Footings, after being formed and prior to pouring.
3. Foundation, prior to backfilling.
4. Post foundation survey.
5. Erosion control, prior to proceeding with framing.
6. Interior sewer.
7. Basement floor, prior to pouring.
8. Plumbing - rough-in.
9. HVAC - rough-in.
10. Electrical service and rough-in.
11. Carpentry - rough-in.
12. All framing of structures.
13. Insulation.
14. Roofing (other than shingle replacement).
15. Final plumbing.
16. Final HVAC.
17. Final electric.
18. Final erosion control.
19. Final carpentry.
20. Occupancy.

C. Other Inspections. In addition to the inspections listed in Section 9.08 B., the Code Official is authorized to make or require any other inspections to enforce any other State and City codes, laws, rules

CODE OF GENERAL ORDINANCES, 2021 - KENOSHA, WISCONSIN

and regulations under the jurisdiction of the Department.

D. Inspection Requests. It shall be the duty of the Permittee or their duly authorized agent to notify the Code Official when Work is ready for inspection. It shall be the duty of the Permittee to provide access to and means for inspection of the Work for any inspections required by this Code.

E. Approval Required. Work shall not be done beyond the point indicated in each successive inspection without first obtaining the approval of the Code Official. The Code Official, upon making the requested inspection, shall either indicate the portion of Work which is satisfactory as completed, or shall notify the Permittee or agent of the Permittee where the Work fails to comply. Any Work which does not comply shall be corrected and shall not be covered or concealed until authorized by the Code Official.

F. Stop Work Order.

1. Authority. Whenever the Code Official finds any Work being performed in a manner contrary to the provisions of this Code, the Code Official is authorized to issue a Stop Work Order.

2. Issuance. The Stop Work Order shall be posted on the Premises where the violation exists, and the owner, owner's agent or contractor doing the Work shall be informed. Upon issuance of the Stop Work Order, the cited Work shall cease immediately. The Stop Work Order shall indicate the reason for the Stop Work Order, and the conditions under which the Work will be permitted to resume.

3. Unlawful Continuance. Any Person who shall continue any Work after having been served with a Stop Work Order, except Work that is allowed to correct a violation, shall be subject to the penalties as provided by this Code.

G. Unsafe Conditions. Any Permittee shall be responsible to maintain the Work Site in a manner so as to be considered safe. The Code Official shall determine any additional safety measures which are to be taken, such as, but not limited to fencing or other acceptable measures.

9.09 CERTIFICATE OF OCCUPANCY

A. Certificate of Occupancy. It shall be unlawful to use or permit the use of any Building or Premises, or part thereof for business purposes, hereafter erected, altered, changed, or converted, wholly or partly, in its use of structure, or where the business Premises or any portion thereof have become vacant, until a Certificate of Occupancy shall have been obtained from the Department of City Inspections.

B. Application for a Certificate of Occupancy. Application for a Certificate of Occupancy shall be made on a form provided by the Department of City Inspections and shall set forth the applicant's name, address, and position or capacity in the business to be carried on.

C. Conditions. A Certificate of Occupancy shall be issued only when it has been determined by the Code Official that all provisions of this Code and the provisions of the City of Kenosha Zoning Ordinance regulating Certificates of Occupancy have been met. No Certificate of Occupancy shall be issued to any Person for any business operation which would violate the Zoning, Fire, Health or other Ordinances of the City, or which would violate any State laws.

D. New Buildings. No Building hereafter erected shall be used or Occupied, in whole or in part, until a Certificate of Occupancy is issued. This requirement does not apply to Accessory Buildings used in conjunction with one and two family Dwellings.

CODE OF GENERAL ORDINANCES, 2021 - KENOSHA, WISCONSIN

E. Change of Use. No Building hereafter enlarged, extended or Altered to change from one use to another, in whole or in part, shall be Occupied, in whole or in part, until a Certificate of Occupancy has been issued.

F. Manufactured/Mobile Homes. Manufactured/Mobile Homes may be issued a Certificate of Occupancy only at such time that the Code Official has determined that required Permits were issued for proper connection of electric service, sewer and water connection, Occupancy and Work has been inspected and approved, all conditions of SPS 326 of the Wisconsin Administrative Code and Chapter 20 of the Code of General Ordinances regulating Manufactured/Mobile Homes have been met, and the Manufactured/Mobile Home bears a Wisconsin insignia of approval.

9.10 ONE AND TWO FAMILY DWELLINGS

A. Application of State Uniform Dwelling Code to One and Two Family Dwellings. The State Uniform Dwelling Code in effect on June 1, 1980, shall apply to all one and two family Dwellings, and shall also apply where Alterations and/or repairs in excess of fifty (50%) percent of the value thereof are made thereto within any period of twelve (12) consecutive months. The value of the Dwellings shall be determined as of the date a Building Permit is applied for without deduction for damage caused by any catastrophe which necessitated repairs.

Where a portion of a one and two family Dwelling becomes damaged or out of repair, or where an Alteration of a portion thereof is sought, and the cost of the repair or Alteration does not exceed fifty (50%) percent of the value thereof, the State Uniform Dwelling Code shall be applicable only to the portion of the Dwelling which is damaged, out of repair, or which is sought to be Altered.

The State Uniform Dwelling Code shall be applicable to all Additions to one and two family Dwellings, irrespective of size.

B. Exterior Building Variation for One and Two Family Dwellings. One and two family Dwellings authorized to be constructed within the City shall conform with the following guidelines:

1. Exterior Building Variation Required. The exterior construction of all one and two family Dwellings shall be varied when the Dwellings are proposed to be constructed upon:

- Lots which share a common side lot line and front upon the same street, including cul-de-sacs.
- Corner lots and the adjacent lots face the intersecting street.
- Lots along the same street and face each other where at least ten (10') feet of frontage is directly opposite the other lot(s), including cul-de-sacs.

2. Exterior Building Variation Defined. A Building shall be deemed to have Exterior Building Variation when the ground level street side view(s) are different in regard to one (1) or more of the following:

- The facade width ground level, street side Building wall framing varies by two (2') feet or more in width.
- The street side roof-wall proportions vary in roof style (i.e., gable, hip, gambrel).
- The roof slope varies by 7.5 degrees or more (i.e., 4/12, 6/12, 8/12).
- The total number, type or symmetrical location of doors, windows, or architectural properties (i.e., fixed window boxes, porches, dormers), and the exterior Building finish (i.e., horizontal banding, vertical banding, diagonal banding, brick, stone, stucco) varies.

3. Evidence of Compliance. Applications for Building and Occupancy Permits shall contain evidence of compliance with this Code in the form of a Certificate of Compliance. Any Permit which is

CODE OF GENERAL ORDINANCES, 2021 - KENOSHA, WISCONSIN

issued in reliance upon false evidence of compliance shall be null and void. The date of issuance of a Permit for the Building on the site shall be the date upon which compliance with this Code shall be determined.

C. Garages. Attached or detached garages shall comply with the following standards:

1. Foundations and Footings. Attached private garages shall be provided with the same type footings and foundations required by this Code for the principal building. Concrete floors shall be not less than four (4) inches in thickness. Detached private garages may be built with a continuous floating slab of reinforced concrete not less than four (4) inches in thickness. Reinforcement shall be a minimum of number 10 six by six (6"x6") inch wire mesh. The slab shall be provided with a thickened edge all around, eight (8) inches wide and eight (8) inches below the top of the slab. The thickened edge shall have two (2) #4 horizontal reinforcement bars placed at the center. The lower reinforcement bar shall be set two (2) inches above the bottom of the thickened edge and the upper reinforcement bar shall be set six (6) inches above the bottom of the thickened edge. Exterior wall curbs shall be provided not less than four (4) inches above the finished ground grade adjacent to the garage. Bolts three-eighths (3/8) inches in diameter with nuts and washers attached, six (6) inches long, shall be embedded three (3) inches in the concrete curb of detached garages, eight (8) feet on centers.

2. Floor Surface. The floor in all private garages shall be of concrete construction and sloped toward the exterior garage door or opening. No openings or pits in the floor shall be permitted, except for drainage.

D. Certificate of Occupancy. Certificates of Occupancy shall not be approved for Buildings not in compliance with this Code.

E. Application Where Existing Development Agreement. This Section 9.10 shall not be applicable to any lot covered by a City approved Development Agreement which contains requirements for Exterior Building Variation.

F. Appeals. The decision of the Code Official respecting Exterior Building Variation may be appealed to the Zoning Board of Appeals upon written Notice of Appeal being filed with the Code Official within ten (10) working days of the issuance of the Permit or a final determination.

9.105 WINDOWS IN HOTEL BEDROOMS

A. Definitions.

Guest Bedroom is a room within a Hotel for use by Transients, which room contains a bed.

Hotel for purposes of this section 9.105 means either a "hotel" or "motel" as those terms are defined in Wis. Stat. § 77.52 (2) (a) 1.

Natural Light is light that comes from the sun.

Transient has the meaning given in Wis. Stat. § 77.52 (2) (a) 1.

Transparent Surface is the transparent portion of a Window.

Window is an opening in the exterior wall of a building that is fitted with transparent glass or other transparent material in a frame to admit Natural Light into a room and to allow people within the room to see out, without distortion.

B. Regulation - Room to Have Windows. Each Guest Bedroom must have at least one Window, which has a Transparent Surface of at least nine square feet (9 ft²), and has a horizontal dimension of at least thirty-six (36) inches.

CODE OF GENERAL ORDINANCES, 2021 - KENOSHA, WISCONSIN

C. Evidence of Compliance. Applications for Building and Occupancy Permits shall contain evidence of compliance with this Code in the form of a Certificate of Compliance. Any such Permit which is issued in reliance upon false evidence of compliance shall be null and void. The date of issuance of a Permit for the Building on the site shall be the date upon which compliance with this Code shall be determined.

D. Certificate of Occupancy. Certificates of Occupancy will not be approved for Buildings not in compliance with this Code.

E. Appeals. The decision of the Code Official may be appealed to the Zoning Board of Appeals upon written Notice of Appeal being filed with the Code Official within ten (10) working days of the issuance of the Permit or a final determination.

9.11 UNSAFE BUILDINGS

A. Unsafe Buildings. Buildings that are or hereafter become unsafe; which are in noncompliance with this Code because of inadequate egress facilities, inadequate light or inadequate ventilation; which constitute a fire hazard or are otherwise dangerous to the public welfare; which involve illegal or improper Occupancy; or, which are vacant and not secured against entry, shall be deemed to be Unsafe Buildings. Unsafe Buildings shall be razed and removed, or made safe as provided in this Code.

B. Renovation. If it is determined that an Unsafe Building is to be renovated so as to make it safe, all repairs, Alterations or Additions shall conform with this Code.

9.12 EXISTING BUILDINGS

A. Scope. The legal Occupancy of any Building existing on the date of adoption of this Code shall be permitted to continue without change, except as provided in this Code.

B. Alterations.

1. Conformance With Code. Alterations to an existing Building shall conform with this Code.

2. Exception. Alterations to existing one and two family Dwellings shall conform with this Code, subject to the following standards.

a. Existing stairways in good repair and not being Altered or replaced may remain in use if the stairway meets the following criteria:

- (1)** Riser height does not exceed eight and one-fourth (8-1/4") inches.
- (2)** Tread depth is not less than eight and one-half (8-1/2") inches.
- (3)** Head room is a minimum of seventy-two (72") inches.
- (4)** Stairway width is at least thirty-four (34") inches.
- (5)** Intermediate baluster spacing is no more than six (6") inches.

b. Existing areas with no framing or restructuring involved maintain a ceiling height of eighty (80") inches.

c. Where ceiling finishes are not removed, installation of battery-operated smoke detectors is acceptable.

d. Where wall or ceiling finishes are not removed, the existing insulation level may remain.

e. Where no wall finishes are removed, the existing receptacle outlet spacing may remain, provided there are at least two (2) separate and remote receptacles located in the room.

f. In the absence of wall or ceiling-type light fixtures, one of the two (2) required receptacle outlets shall be controlled by a remote switch.

CODE OF GENERAL ORDINANCES, 2021 - KENOSHA, WISCONSIN

The application of the aforementioned standards may be appealed in writing to the Code Official authorized to grant modifications for good cause.

C. Additions. Additions to an existing Building shall conform with this Code.

D. Conformance of Alterations and Additions. If an Alteration or Addition exceeds fifty (50%) percent of the gross area of the existing Building, the entire Building shall be made to conform with this Code.

E. Change of Occupancy Classification. When a change in Occupancy classification of an existing Building occurs, all provisions of this Code shall be met prior to approval of Occupancy.

9.13 TEMPORARY BUILDINGS AND USES

A. General. The Code Official is authorized to issue a Permit for temporary Buildings and temporary uses which shall be limited as to duration of use, but in no event be permitted for more than one hundred eighty (180) days. The Code Official is authorized to grant an extension for good cause.

B. Conformance. Temporary Buildings and uses shall conform with this Code.

9.14 STREET OCCUPANCY FOR DUMPSTERS

A. General Provisions.

1. Street Opening/Occupying Permits For Temporary Placement of Dumpsters. Street Opening/Occupying Permits issued by the Department of Public Works may be approved only for the temporary placement of dumpsters used during the course of demolition or construction.

2. Department of Public Works Approvals. Street occupancy for the placement of other materials, machinery, barricades or vehicles used in conjunction with demolition, construction or any other purpose may be approved by the Department of Public Works in accordance with Chapter 5 of the Code of General Ordinances.

B. Permit.

1. Application. Application for a Street Opening/Occupying Permit to place a temporary dumpster in the right-of-way shall be made on forms provided by the Department of Public Works. The application shall state the duration of the requested street occupancy.

2. Certificate of Insurance. The applicant shall file with the application a Certificate of Insurance indicating that the applicant is insured for liability in the minimum amount of Two Hundred Fifty Thousand (\$250,000.00) Dollars per person, One Million (\$1,000,000.00) Dollars per occurrence, and Fifty Thousand (\$50,000.00) Dollars for property damage.

C. Permit Conditions. Street Opening/Occupying Permits shall be subject to the following conditions:

1. Use of Right-of-Way. The Permit shall not authorize the use of more than one-third (1/3rd) of the right-of-way between curb lines, and shall be restricted to the use of that portion of street right-of-way which is closest to the curb. No other portion of the right-of-way may be used without the written approval of the Department of Public Works.

CODE OF GENERAL ORDINANCES, 2021 - KENOSHA, WISCONSIN

2. Pedestrian Access. A minimum of four (4') feet in width shall be maintained on all sidewalks requested to be occupied for pedestrian access.

3. Obstruction of Fire Hydrant/Railway Track/Traffic Lanes/Arterial Streets. The Permit shall not authorize placement of dumpsters within twenty-five (25') feet of any fire hydrant, within ten (10') feet of any railway track, or in any active traffic lane or arterial street.

4. Dumpsters. Dumpsters shall be clearly marked with flashers, barricades or reflective tape. Barricades shall not extend further into the street right-of-way than the width of the dumpster.

5. Additional Measures and Restrictions. Additional measures and restrictions may be imposed on a case-by-case basis as deemed necessary by the Code Official to protect the public health, safety and welfare.

6. Permit Denial.

a. No Permit shall be issued to any Person to use the right-of-way where the placing of the dumpster will unreasonably interfere with the public health, safety and welfare.

b. Permits shall be denied in every case where there is sufficient room for the dumpster upon the Premises served.

9.15 VACANT BUILDINGS

A. Definition. "Vacant Building(s)" shall mean a Building in which there has been no legal Occupancy for more than ninety (90) days.

B. Certificate of Occupancy. No Vacant Building shall be Occupied or otherwise used without first obtaining a Certificate of Occupancy.

C. Conformance. Prior to receiving Occupancy approval, Vacant Buildings shall be inspected for conformance with this Code.

9.16 MOVING OF BUILDINGS

A. Prohibitions.

1. Permit Required. No Building shall be moved within, through, into or out of the City of Kenosha without first obtaining a Permit as hereinafter specified.

2. Building Unsafe or Unfit - Unreasonable To Repair. No Building shall be allowed to be moved within, through, into or out of the City of Kenosha if deemed by the Code Official to be unsafe or unfit and unreasonable to repair.

B. Application For Permit. An application or a Permit For Moving A Building shall be made on forms designated by the Department. In addition to the information requested on the application, the applicant shall also include the following:

1. A letter indicating the existing location of the Building, as well as the proposed new location for the Building.

2. A detailed description of the Building to be moved.

CODE OF GENERAL ORDINANCES, 2021 - KENOSHA, WISCONSIN

3. The proposed date and time of the move, including completion date.

C. Application Approval. The application shall be forwarded to the Mayor, Alderpersons of any district through which said Building will pass, the Director of Public Works, the Police Chief and the Fire Chief.

The Director of Public Works shall approve the route proposed, if acceptable. If the proposed route is not acceptable, the applicant may amend the application to propose an acceptable route, altering the size of the Building, and changing the day and time of the proposed move.

Upon receiving approval of the route, the Code Official shall review the application for conformance with this Code and approve the Permit for issuance when the conditions for the Permit and this Code have been met.

D. Permit Denial. A Permit For Moving A Building may be denied for any of the following reasons:

1. Undue burden upon the City or public utilities in making accommodations for the move.
2. Use and/or location of moved Building will not be in conformance with a Master Plan or the Zoning Ordinance.
3. If an intended use requires a Conditional Use Permit, Site Plan Review or any other Permit, license or authorization, the Code Official shall deny the Permit until such time that required Permits, licenses or authorizations for the intended use are received.

E. Conditions.

1. Completion/Surety Bond. Moves, once commenced, shall be completed promptly, and the mover shall post a Surety Bond in the amount of Fifty Thousand (\$50,000.00) Dollars guaranteeing completion of the move in conformance with this Code within the time specified on the application, as approved.

2. Notification of Move Commencement and Completion. The mover shall notify the Code Official of the time the move is commenced and completed.

3. Obstruction of Streets, Traffic; Access to Fire Hydrants and Building. No Building shall be allowed to remain overnight upon any street crossing or intersection, or be permitted to obstruct traffic or access to any fire hydrant or Building.

4. Move During Period of Sunset to Sunrise; Inclement Weather. Red lights shall be attached at each corner of and every twelve linear (12LF) feet of any Building being moved within a street right-of-way during the time period from sunset to sunrise, and during periods of inclement weather.

5. Inspection Upon Completion of Move. Upon completion of the move, City departments shall make an inspection of the move route. Any damages caused by the move on the route shall be noted in written form, and a written report shall be forwarded to the mover and the owner of the Building.

6. Responsibility for Move Costs. The owner is responsible for all costs involved in the move, including utility relocation and tree trimming. The mover is responsible for all damages and injuries caused by the move.

CODE OF GENERAL ORDINANCES, 2021 - KENOSHA, WISCONSIN

7. Bond Forfeitures. The Code Official is authorized to seek bond forfeitures whenever a default has occurred.

F. Conformance. The application for a Permit For Moving A Building, upon approval, constitutes an agreement by the owner to bring the Building, when moved to a new location in the City, into conformance with this Code and any other required City and State rules, laws and regulations.

9.17 RAZING OF BUILDINGS

A. Permit. No Person shall raze any Building within the City without first obtaining a Raze Permit from the Department.

1. Application. The owner of the Building to be razed shall sign the Application For Raze Permit. In the alternative, an agent for the owner may sign the Application for Raze Permit upon providing written authorization verifying permission of the owner to apply for the Raze Permit. The Code Official may require additional information and other State or local Permits as required by law, rule or regulation.

2. Fees. Raze Permit fees shall be established by the City of Kenosha Common Council.

3. Performance and Payment Bond. Any application for a Raze Permit to engage in the razing of Buildings within the boundaries of the City shall be accompanied by a Performance and Payment Bond, approved by the City Attorney as to form, in the amount of the actual cost of the Work. The bond shall guarantee that all Work is performed in accordance with this Code and other State and local laws, rules and regulations, and hold the City harmless from any costs and expenses arising from the Work and secure timely performance of the Work. The City may reasonably require a bond of a greater amount, on a case-by-case basis, where deemed necessary, to protect the City. In extraordinary circumstances, the Common Council may allow for an alternate form of security in an amount deemed reasonably necessary and sufficient.

4. Comprehensive Liability Insurance. An applicant for a Raze Permit shall provide proof of comprehensive liability insurance in the amount of One Million (\$1,000,000.00) Dollars per occurrence and per person and Fifty Thousand (\$50,000.00) Dollars property damage.

5. Disconnection of Utilities. The Permittee shall be responsible for the disconnections of utilities necessary for the razing, and shall provide evidence that necessary disconnections have been accomplished.

B. Permit Conditions. All Raze Permits shall be subject to the following conditions:

1. Permit Term. The razing of a Building shall be completed within thirty (30) days after the date the Raze Permit was issued. The Code Official may at his/her discretion extend the Permit term for cause. "Cause" shall mean the inability of the Permittee to act due to circumstances beyond Permittee's reasonable control upon the exercise of due diligence.

2. Inspection of Work. Work done under a Raze Permit is subject to inspection by the Code Official who shall have the authority to order corrective Work. Failure to follow the orders of the Code Official, or to complete the raze in accordance with this Code, shall give the Code Official authority to seek restitution from the required bond.

3. Foundation of Razed Building. Unless otherwise approved by the Code Official, whenever a Building has been razed, the foundation, if any, shall be removed and filled in with clean fill material

CODE OF GENERAL ORDINANCES, 2021 - KENOSHA, WISCONSIN

approved by the City Engineer with the top two (2') feet of fill material being dirt or sand. No combustible material may be used for the fill material.

4. Driveway Approaches, Driveway Aprons, Sidewalks and Slabs. Remaining Driveway Approaches shall be removed and replaced with curbs and gutters; damaged public sidewalks shall be replaced; and Driveway Aprons, remaining slabs and private sidewalks shall be removed from the site prior to final approval. Permits for replacing curbs and gutters, Driveway Approaches and public sidewalks shall be obtained from the Department of Public Works.

5. Site Grading. Whenever a Building has been razed, the site shall be graded with a minimum of three (3") inches of topsoil, with seed and mulch or sod applied to cover the entire disturbed area.

6. Disposal of Debris. The Permittee shall dispose of all Building debris in a licensed landfill, except for salvaged materials. At any time, the Permittee shall provide to the Code Official receipts and/or an itemized list of debris disposed of by dumping or salvage.

7. Site Safety and Security. The Permittee shall, during the razing process, maintain the razing site in a safe and secure condition, and the Permittee shall promptly report any personal injury and property damage to the Code Official. The Code Official may require additional safety and security methods, including fencing and gating, as deemed necessary to protect the site and restrict access to the public.

C. Exemption. After consideration of the factors in this Subsection C., the City Engineer or his or her designee, which designee is a licensed engineer, may grant an exception for any property for which the City will be taking title to the removal and/or filling provisions of paragraph B.3 and/or the removal and replacement provision of paragraph B.4 and/or the grading or seeding provisions of paragraph B.5. In the exercise of discretion in granting an exception, the City Engineer or his or her designee, shall consider the following factors:

1. Type of contamination that may be on the property or the larger, integrated site associated with the Building to be razed;
2. Suspected level of contamination on the property based on best evidence available;
3. Possible vectors of migrations from the property;
4. Any known migration of contamination from the property;
5. Reasonableness of other means of remediation or containment;
6. Any communication from the state or federal government suggesting the necessity or adequacy of maintaining the foundation, or portion thereof, for environmental protection.

D. Exemption.

1. Residential Remodeling. This Section shall not be construed to apply to contractors or homeowners doing demolition Work on part of a Building which is necessary in the course of Building Construction Work being conducted under a Building Permit.

2. Accessory Buildings and Detached Garages. This Section shall not apply to demolition of Accessory Buildings or detached garages not greater than five hundred (500) square feet.

E. Raze Order Costs. The cost of razing or securing a Building subject to a raze order together with a One Hundred (\$100.00) Dollar administrative fee shall be assessed as a special charge against the real estate upon which the Building is located, shall accrue interest at the rate established in Section 2.10 of the Code of General Ordinances, and shall be a lien against the real property until paid in full. The

CODE OF GENERAL ORDINANCES, 2021 - KENOSHA, WISCONSIN

administrative fee is to cover the administrative costs of assessing the special charge against the real property.

9.18 SWIMMING POOLS; HOT TUBS; SPAS

A. Permit Required. No Person shall construct, build, rebuild, Alter, modify or improve any swimming pool, hot tub or spa without first obtaining a Permit to do so. The applicant shall possess a valid Wisconsin Master Electrician's License.

B. Application for Permit. The application for a Permit shall be fully completed and include a Site Plan, as well as a copy of Plans and specifications for the Work proposed.

C. Inspections, Approvals and Insignia. No swimming pool, hot tub or spa shall be used or made available for use until the Code Official has inspected and approved the installation as being in conformance with this Code and has issued an insignia indicating approval. The insignia shall be permanently affixed by the Code Official in a conspicuous manner.

D. Regulations.

1. Electrical Conductor Clearance. Clearance from overhead or underground electrical conductors, whether private or utility-owned, shall be in conformance with SPS 316 of the Wisconsin Administrative Code, and Article 680 of the National Electrical Code.

2. Exemption. Swimming pools, hot tubs, and spas are exempt from the maximum lot coverage provision of the City of Kenosha Zoning Ordinance.

E. Enclosures of Swimming Pools, Hot Tubs, or Spas.

1. Requirements.

a. Every swimming pool, hot tub or spa which has a water depth of two (2') feet or more shall be completely surrounded by a fence or wall at least forty-eight (48") inches in height and not more than six (6') feet in height, nor less than forty-eight (48") inches in height above adjoining grade, in addition to the pool wall of an above ground pool.

b. The enclosure shall be provided with a self-closing and self-latching gate or door, or made inaccessible to children by means approved by the Code Official.

c. All enclosures constructed at a height of less than six (6') feet shall be located a minimum horizontal distance of four (4') feet from the edge of the swimming pool, hot tub or spa.

d. A Building, deck, existing wall or other barrier complying with the requirements specified in this Section may be used as part of the required enclosure with the approval of the Code Official.

2. Exceptions. Swimming pools, hot tubs or spas which have a pool wall of four (4') feet or higher above grade shall be exempt from the fencing requirement, provided that the ladder or steps up to the pool, hot tub or spa are hinged at the top and capable of being raised out of the reach of children.

Hot tubs and spas equipped with a fitted cover and capable of supporting a minimum of one hundred (100 lbs.) pounds shall be exempt from the enclosure requirements.

F. Electrical Service and Wiring. The provisions of SPS 316 of the Wisconsin Administrative Code and Article 680 of the National Electric Code regarding minimum requirements for installation of electrical wiring and equipment in or related to swimming pools, hot tubs or spas are hereby adopted by reference

CODE OF GENERAL ORDINANCES, 2021 - KENOSHA, WISCONSIN

and made part of this Code.

G. Draining. Swimming pools, hot tubs and spas shall be drained in such a manner as not to create a public or private nuisance, not to allow water to flow upon any adjacent property without the consent of the owner or occupant of the adjacent property, not to create a hazard on any public right-of-way for vehicular or pedestrian traffic, and not to enter any sanitary sewer.

9.19 PLUMBING QUALIFICATIONS

No Person shall engage in plumbing or act as an Automatic Fire Sprinkler System Apprentice, Journeyman Automatic Fire Sprinkler Fitter, Journeyman Plumber, Master Plumber, Plumbing Apprentice, Registered Learner, Restricted Plumber Licensee or Utility Contractor as defined in Section 145.01, Wisconsin Statutes, nor apply for a Permit to do such Work, without first being licensed, certified or registered as required by Chapter 145, Wisconsin Statutes, and complying with all applicable State laws, rules and regulations.

9.20 ELECTRICAL

A. Qualifications. No Person, except as provided in Subsections B., C., and D. herein, shall install electrical wiring and equipment within the City, or apply for a Permit for which the performance by a licensed contractor is applicable, without first obtaining certifications as required by Section 101.862, Wisconsin Statutes, and conforming with all applicable State laws, rules and regulations.

B. Owner Occupied Residential Property. Property owners may install electrical wiring and equipment within the City for single family Dwellings which they occupy, upon obtaining a Permit from the Department to do so. The Permit shall be issued only after passing an exam administered by the Department to demonstrate that he/she is competent to perform the Work in conformity with applicable State and City laws, rules and regulations.

Owners/occupants of single family Dwellings who pass the exam are prohibited from performing electrical wiring or Alteration of service entrance equipment and panels.

C. City Employees. City employees may install electrical wiring and equipment for the City upon being trained to perform the Work in conformance with State and City laws, rules and regulations.

D. Low Voltage Wiring. Any Person shall be exempt from this licensing requirement if the sole scope of the electrical Work to be performed is limited to low voltage wiring. Low voltage wiring performed on one and two family Dwellings is exempt from the Permit requirement.

E. Energizing New or Temporary Electrical Service. It shall be unlawful for a utility furnishing electric power within the City to energize a new or temporary service prior to an inspection of the Premises to be served being made by the Code Official, and prior to the Code Official approving the installation and notifying the utility.

F. City Mandated De-Energization of Electrical Service. The Code Official, upon discovering an energized electrical service which constitutes a potential hazard to Person or property, may, in writing, direct a utility furnishing such electrical service to de-energize the electrical service. It shall be unlawful for a utility to fail to promptly comply with the written directive within a reasonable time, except where to do so would de-energize the electrical service of a non-offending third party sharing the same service connection. A copy of the written directive shall be furnished forthwith to the owner/occupier of the Premises to be de-energized, whenever possible.

CODE OF GENERAL ORDINANCES, 2021 - KENOSHA, WISCONSIN

G. Residential Electrical Wiring. Any Alteration to any portion of residential electrical service equipment shall conform to the following provisions:

1. The electric service shall be a minimum of one hundred (100) amperes for a single family Dwelling, and one hundred fifty (150) amperes for a two family Dwelling. Service conductors and all associated equipment shall be new. All Work shall be installed pursuant to the National Electrical Code, SPS 316 of the Wisconsin Administrative Code, and the current WE Energies Service and Metering Manual.

2. All Dwelling Units shall be metered separately.

3. All banded meter sockets shall be replaced.

4. Property shall be supplied by only one (1) riser and service.

5. Service shall be located a minimum of three (3') feet horizontally from gas service.

6. Where electrical Work is done in a basement or attic, knob and tube wiring, if present, shall be removed and replaced with wiring in conformance with this Code.

7. Illumination shall be provided at all stairways and exits. Stairways going to a habitable room shall be provided with a three-way switch.

8. Convenience outlets shall be located as needed to prevent the use of extension cords.

9. When receptacles are being replaced in basements, crawl spaces, kitchens and bathrooms they shall be GFCI protected.

10. In Accessory Buildings with electrical wiring a ground receptacle shall be provided and shall be ground fault protected when replaced in existing outlet.

11. The Permit shall be conditioned upon all safety violations being corrected.

9.21 HVAC

A. Qualification. No Person shall install or modify permanent heating, ventilating or air conditioning equipment without first obtaining a Wisconsin HVAC Qualifier Credential, and/or being in possession of a City of Kenosha HVAC Contractor License. This licensing requirement shall not apply to employees of State regulated utilities.

Any Person installing or Altering gas lines shall possess a valid State of Wisconsin Master Plumber License.

B. City HVAC License. A current City HVAC Contractor License shall be required of any City HVAC Contractor License holder licensed by the City prior to May 1, 2007, who does not possess a Wisconsin HVAC Qualifier Credential. Contractors who possess a valid Wisconsin HVAC Qualifier Credential are not required to maintain, hold or obtain a City HVAC Contractor License.

C. Renewal of License. The Common Council shall, from time to time, establish by Resolution the fee for a City HVAC Contractor License renewal. The license renewal fee shall be submitted to the City Clerk/Treasurer. License fees shall be nonrefundable and shall not be prorated for the license term.

CODE OF GENERAL ORDINANCES, 2021 - KENOSHA, WISCONSIN

Licenses not renewed in a timely manner shall become null and void.

D. License Term. The license term shall be from May 1 through April 30.

E. License Conditions. Licenses shall be conditioned upon:

1. Performing licensed activities in conformance with applicable State and City laws, rules and regulations.

2. Performing licensed activities only after taking out the required Permit(s).

F. License Suspension and Revocation. The Code Official may suspend or revoke any license issued hereunder, for cause, upon ten (10) days advance, written notice to the license holder, specifying the basis for the suspension/revocation and notice of an opportunity to be heard. The decision of the Code Official may be appealed to the Committee on Licenses/Permits within ten (10) days of the date of issuance.

9.22 AIR CONDITIONING EQUIPMENT LOCATION ON SINGLE, TWO-FAMILY AND MULTI-FAMILY RESIDENTIAL BUILDINGS

A. Requirement. Permanently installed air conditioning condensers for central air conditioning systems serving single, two-family and multi-family residential Buildings shall be located on the side lot or rear lot as defined in the Zoning Ordinance.

B. Exception. An exception may be granted by the Code Official if the air conditioning condenser cannot be feasibly located on the side or rear lot due to unusual circumstances, such as lot configuration, site improvements, and structural and mechanical restrictions. In such event, the air conditioning condenser may be located in the front yard as defined in the Zoning Ordinance, upon the condition that it be screened by evergreen shrubs or other means approved by the Code Official. The exception and basis therefor shall be noted in the Permit file.

9.23 STREET NUMBERING

A. Numbering. All Buildings in the City of Kenosha shall be numbered in accordance with a certain book now on file in the office of the Department of Public Works, which is designated Address Book. All Buildings shall be numbered to conform as nearly as possible to the general scheme of numbering as outlined in the Address Book, and in accordance with the Official City Street Map.

B. Correcting Existing Numbers. The owner of any Building, which is not numbered or is incorrectly numbered, shall cause the Building to be numbered, or renumbered, as the case may be, not later than thirty (30) days from the receipt of notice from the Code Official and shall thereafter maintain the Building number in compliance with this Ordinance.

C. Numbers, Size and Location. For all one or two-family Dwellings, the numbers shall not be less than 2-1/2 inches in height and shall be conspicuously placed near the front or main entrance door of each Dwelling so that the number can be plainly seen from the street. For apartments, multiple family Dwellings, institutional and commercial Buildings, the numbers shall not be less than six (6") inches in height. Whenever any Building is situated more than fifty (50) feet from the street line, the number of the Building shall be conspicuously displayed behind the sidewalk, near the driveway or common entrance to the Building or upon a gate, post or other appropriate place so as to be easily discernible from the street, but so as not to obstruct the vision of motor vehicle operators.

CODE OF GENERAL ORDINANCES, 2021 - KENOSHA, WISCONSIN

D. Multiple Family Residential and Commercial Buildings. Multiple family residential and commercial Buildings will be assigned one numerical address. The owner(s) of any multiple family residential or commercial Building shall number each Building in accordance with the officially assigned address. In addition, whenever feasible, such feasibility to be determined by the City Engineer, the owner shall number each Dwelling Unit separately with a letter designation (e.g., Apartment A). In the case of multi-storied Buildings, the owner may assign numbers to each unit, such as first floor 100 series, second floor 200 series, (e.g., Apartment 101), etc.

E. Duties of the City Engineer. It shall be the duty of the City Engineer, or his/her designee, to inform any party applying therefor of the number or numbers applicable to any Building as provided by this Ordinance. The City Engineer shall keep the Address Book current and the Address Book shall be open to inspection during regular office hours.

9.24 SIDEWALK; CURB AND GUTTER; DRIVEWAY APPROACHES; DRIVEWAY APRONS

A. Damage to Sidewalk, Curb and Gutter, and Driveway Approach to be Repaired. It is unlawful to crack, break, displace or otherwise damage a public sidewalk, curb and gutter, or Driveway Approach in the course of performing Work under this Code, unless a Permit is obtained from the Department of Public Works.

B. Permit Required. Repairs, replacement and modification of any public sidewalk, curb and gutter, or Driveway Approach shall be done only after a Permit has been obtained from the Department of Public Works.

C. Driveway Aprons. Driveway Aprons must be installed to prevent storm water runoff from flowing onto adjoining property. Driveway Aprons must be sloped toward the public right-of-way where motor vehicles will ingress and egress the property. Driveway Aprons determined by the Director of City Inspections or his/her designee not to be in compliance with this Section shall be brought into compliance by following directives of the Director of City Inspections or his/her designee.

All properties shall have a Driveway Apron constructed of a minimum of four inches (4") of bituminous concrete, asphalt or Portland Cement concrete no later than six (6) months after the issuance of the Certificate of Occupancy.

D. Conformance. In the event the Director of City Inspections or his/her designee determines that a public sidewalk, Driveway Approach, curb, gutter or Driveway Apron has been installed in violation of this Code, or that damaged public sidewalks, Driveway Approaches, curbs and gutters or Driveway Aprons have not been repaired to minimum City standards, a Certificate of Occupancy shall not be issued until such time that public sidewalks, Driveway Approaches, curbs and gutters and Driveway Aprons have been installed or repaired in conformance with this Code.

9.25 DOWNSPOUT DISCHARGE

No Person may install or maintain a downspout which discharges storm water less than three (3') feet from any property line, unless the water flow from the discharge is directed either perpendicular to any public right-of-way adjacent to the property, or to a public drainage swale approved by the Department of Public Works.

9.26 RETAINING WALLS

A. Permit Required. No Person may construct, build, Alter or modify any retaining wall over the height of five feet (5') without first obtaining a Retaining Wall Permit from the Department of Community

CODE OF GENERAL ORDINANCES, 2021 - KENOSHA, WISCONSIN

Development and Inspections.

B. Application. Application for a Retaining Wall Permit shall be made by a fully completed, City-provided application form, and submitted along with two (2) sets of plans and specifications, a letter from a licensed civil engineer approving the plans and specifications, and the Retaining Wall Permit.

9.27 EXCAVATIONS; DEPRESSIONS; PITS

A. Definitions.

1. **Hazardous Depression** shall mean any excavation, pit, hole, gully, ditch or depression of any nature wherein water is accumulated and retained for more than twenty-four (24) hours; wherein trash, debris or odorous or otherwise objectionable material accumulates; or, which, in the judgment of the Code Official, otherwise constitutes a danger to the public safety and welfare.

2. **Building Excavation** shall mean the excavation made for the basement or foundation of a Building.

B. Public Nuisance. Hazardous Depressions are hereby determined to constitute a public nuisance.

C. Abatement.

1. **Hazardous Depressions.** In all cases where the Code Official finds a Hazardous Depression constituting a public nuisance, the Code Official shall serve upon the owner of the property a notice requiring the abatement thereof within ten (10) days of the date of notice by filling in the Hazardous Depression or by taking other such measures as the Code Official deems necessary. Filling, in all cases, shall be done with materials and in a manner approved by the Department of Public Works to insure that natural drainage is not unduly blocked or hampered. In the event the owner of the property shall neglect or refuse to abate the public nuisance in the manner prescribed, the Code Official shall cause the public nuisance to be abated. The cost to abate the public nuisance together with a One Hundred (\$100.00) Dollar administrative fee shall be assessed as a special charge against the property, shall accrue interest at the rate established in Section 2.10 of the Code of General Ordinances, and shall be a lien against the property until paid in full. The administrative fee is to cover the administrative costs of assessing the special charge against the property.

2. **Building Excavations.** If a Building Excavation is deemed by the Code Official to be a Hazardous Depression, it shall be subject to abatement as set forth in Subsection 9.27 C.1. If construction on the Building within the Building Excavation is not commenced within six (6) months after breaking ground, the Code Official may serve an order upon the owner of the property and the holder of any encumbrance of record that the erection of the Building begin forthwith, or that the Building Excavation be filled to lot grade within fifteen (15) days. In the event the owner or encumbrance holder neglects or refuses to comply with the order of the Code Official, the Code Official shall cause the abatement work to be done in a manner approved by the Department of Public Works as to drainage, and the cost thereof shall be assessed against the property as provided in Subsection 9.27 C.1.

3. **Exceptions.** This Code shall not apply to Lake Michigan, the Pike River, Pike Creek, natural wetlands, lakes and lagoons located on any property which are part of an approved subdivision plat, or any storm water ditch or water retention basin located on public or private property which are part of a City-approved Storm Water Drainage Plan or part of a statutory Drainage District.

CODE OF GENERAL ORDINANCES, 2021 - KENOSHA, WISCONSIN

9.28 STRUCTURAL INTERFERENCE WITH PUBLIC SAFETY RADIO COMMUNICATION

A. Definitions.

1. **Terms.** The following terms for purposes of this section shall have the respective meanings:

Basement. Any story where less than half of the height between the floor and ceiling is above the average level of the street, sidewalk or finished grade.

Code Official. The Director of the Department of City Inspections, any successor to the position, or any duly authorized designee of the Director or successor.

NFPA. National Fire Code, 2006 Edition, and future amendments thereto as recommended by the National Fire Protection Association (hereinafter referred to as "NFPA (Section Number)") that have been adopted by the City of Kenosha, either directly, or through adoption of state regulations that have adopted the codes.

Responsible Person. The owner, operator or manager of any structure or premises, whether they be a person, partnership, corporation, non- stock corporation, limited liability company, limited liability partnership, association, or syndicate.

2. **Terms Defined Elsewhere.** Where terms are not defined in this Code and are defined in other City Ordinances, Codes, or ASHRAE and NFPA 70, such terms shall have the meanings ascribed to them therein in those Codes.

3. **Terms Not Defined.** Where terms are not defined herein, or through the methods of interpretation authorized by this Section, such terms shall have ordinarily accepted meanings, such as the context indicates.

B. General. Except as otherwise provided, no person or organization shall maintain, own, erect or construct any building or structure which is used for commercial, multi-family, or institutional use or any part thereof or cause the same to be done which fails to support adequate radio coverage to public safety service workers, including but not limited to firefighters and police officers. For purposes of this section, adequate radio coverage shall include all of the following:

1. A minimum signal strength of -101 dBm available in 95% of the area of each floor of the building when transmitted from the Public Safety Radio Communications Systems; and

2. A minimum signal strength of -101 dBm received at the Public Safety Radio Communications System when transmitted from 95% of the area of each floor of the building, via portable radio with or without public safety microphone.

3. Channel Performance Criterion (CPC): CPC is the minimum performance level in a faded channel, per TSB-88, clause 4.2. TSB-88 is a "Telecommunications Systems Bulletin" published by the TIA, Telecommunications Industry Association. The performance level is rated using "Delivered Audio Quality". Industry standard DAQ definitions are shown in Table 1.

4. DAQ level of 3 is the minimum performance level which shall be attainable by Public Safety Radio systems in 95% of the area of each floor of a building subject to this chapter.

CODE OF GENERAL ORDINANCES, 2021 - KENOSHA, WISCONSIN

Table 1 -Delivered Audio Quality Definitions

DAQ Delivered Audio Quality	Subjective Performance Description
1	Unusable, speech present but unreadable.
2	Understandable with considerable effort. Frequent repletion due to noise / distortion.
3	Speech understandable with slight effort. Occasional repetition required due to noise / distortion.
3.5	Speech understandable with repletion only rarely required. Some noise /distortion.
4	Speech easily understood. Occasional noise / distortion.
4.5	Speech easily understood. Infrequent noise / distortion.
5	Speech easily understood.

5. The frequency range which must be supported shall be 150.0000 - 160.0000 MHz, in both digital and analog signals.

6. The Kenosha Fire and Police Departments may alter necessary frequencies or signal strengths due to changes in technical specification for public safety radio requirements or in the event frequency changes are required by the FCC. Any such frequency changes shall be reported to the Common Council and approved as amendments to this ordinance as soon as is practicable. The Responsible Person shall modify or expand the emergency responder radio coverage system at their expense for the additional frequencies. Prior approval of a public safety radio coverage system on previous frequencies does not exempt this section.

C. Testing Procedures.

1. **Initial Tests.** Upon completion of installation of an emergency responder radio coverage system, the building owner shall have the radio system tested to ensure that two-way coverage on each floor of the building is in accordance with Section B.

2. **Annual Tests.** The Responsible Person will cause to be conducted annual tests. The Responsible Person shall file the report generated in paragraph C.3. with the Code Official each year within thirty (30) days of the testing, but in no event later than April 30. The tests will require:

a. In-building coverage tests will be conducted to assure compliance with the standards described in Subsections B 1-6.

b. Signal boosters shall be tested to ensure that the gain is the same as it was upon initial installation and acceptance.

c. All other active components shall be checked to verify operation within the manufacturer's specifications.

3. **Tester Qualifications.** The tests must be conducted, documented, and signed by a person in possession of a current General Radiotelephone Operator license issued by the United States Federal Communications Commission, or a current technician certification issued by a nationally recognized organization or school, or a certificate issued by the manufacturer of the equipment being installed.

CODE OF GENERAL ORDINANCES, 2021 - KENOSHA, WISCONSIN

D. Maintenance.

1. The emergency responder radio coverage system shall be maintained operational at all times in accordance with Subsection B.
2. Except as otherwise specified herein, each Responsible Person or tenant where relevant, as designated herein, shall be responsible for the maintenance required under this Code and subject to penalty for conviction of any violation of this Code.

E. Amplification Systems Allowed.

1. Buildings and structures which cannot independently support the required level of radio coverage shall be equipped with any of the following in order to achieve the required adequate radio coverage: a radiating cable system or an internal multiple antenna system with or without FCC type-accepted signal booster amplifiers as needed.

The installation of equipment as indicated above can not be detrimental to the operation of the Public Safety Radio System.

2. In the event that a signal booster is employed it shall meet the following minimum requirements:
 - a. be fully encased within a dust resistant case;
 - b. be contained in a National Electrical Manufacturer's Association (NEMA) 4-type waterproof cabinet;
 - c. battery systems used for the emergency power source shall be contained in a NEMA 4-type waterproof cabinet;
 - d. the signal booster system and battery system shall be electrically supervised and monitored by a supervisory service, or shall sound an audible signal at a constantly attended location; and
 - e. have FCC certification prior to installation.

F. Secondary power.

Emergency responder radio coverage systems shall be provided with an approved secondary source of power conforming to NFPA 72. The secondary power supply shall be capable of operating the emergency responder radio coverage system for a period of at least twenty-four (24) hours. When primary power is lost, the power supply to the emergency responder radio coverage system shall automatically transfer to the secondary power supply.

G. Field Testing.

1. Fire Department and Law Enforcement Personnel, after providing reasonable notice to the owner or his representative, shall have the right to enter onto the property to conduct field testing to be certain the required level of radio coverage is present.
2. Every Responsible Person shall cooperate with and facilitate Field Testing. Failure by the Responsible Person to cooperate with and facilitate such Field Testing shall be a violation of this Code.
3. No person, whether the Responsible Person or otherwise, may obstruct the Field Testing. Obstruction includes the denial of entrance into the building or structure, or portion of the building or structure, at reasonable times pursuant to reasonable notice.

CODE OF GENERAL ORDINANCES, 2021 - KENOSHA, WISCONSIN

H. Exemptions.

The following buildings are exempt from the requirements of this ordinance:

1. A building containing a wired communication system in accordance with Subsection B that has been permitted by the Code Official to be installed or maintained in lieu of a radio coverage system for buildings. The communications control equipment and portable handsets shall be located inside the building at the main building entrance, or other location approved by the Code Official.
2. Buildings and areas of buildings that have minimum radio coverage signal strength levels within the building in accordance with Subsection B, herein, without the use of a radio coverage system.
3. Buildings meeting all of the following conditions:
 - a. there are not more than five stories above grade;
 - b. the total building area, including occupiable space created after July 1, 2015, does not exceed 100,000 square feet;
 - c. the total basement area does not exceed 5,000 square feet; and
 - d. there are no building spaces having a floor level used for human occupancy that are more than 30 feet below the finished floor of the lowest level of exit.
4. One and two family dwellings.
5. In facilities where emergency responder radio coverage is required and such systems, components or equipment required could have a negative impact on the normal operations of that facility, the Code Official shall have the authority to accept an automatically activated emergency responder radio coverage system.
6. A building that is existing and has been legally occupied prior July 1, 2015, provided, however, that with the additional occupiable space created after July 1, 2015, the building remains exempt under paragraphs H.1 through 4.

I. Enforcement.

1. Any person who violates a provision of this Code, shall, upon conviction, be subject to a forfeiture of not more than One Thousand (\$1,000.00) Dollars, and in addition, shall pay the costs and expenses of prosecution. Each day such violation continues shall be considered a separate offense. Failure to promptly pay said forfeiture shall subject the violator to be sentenced to the County Jail for a period not to exceed sixty (60) days. Each day a violation exists, or continues, shall constitute a separate offense.
2. In addition to the forfeitures described above, the City Attorney shall be authorized to seek injunctive relief as appropriate to bring buildings into compliance with this provision.

9.29 APPEALS

Any person wishing to appeal an interpretation of this Code by a Code Official, or by an action taken against a license, may do so by the following means.

A. State of Wisconsin Building Code, Plumbing Code, Electric Code, Heating, Ventilating and Air Conditioning Code or State Statute. Appeals are to be made in writing on forms provided by the Wisconsin Department of Safety and Professional Services.

CODE OF GENERAL ORDINANCES, 2021 - KENOSHA, WISCONSIN

B. City of Kenosha Zoning Ordinance. Appeals are to be made in writing on forms available from the Department, submitted together with the appropriate fee, to the Zoning Board of Appeals.

C. City License. Appeals regarding actions taken against a City HVAC Contractor or City Demolition Contractor shall be made in writing to the Committee on Licenses/Permits.

D. State License or Registration. Appeals regarding actions taken against a Master Plumber, Master Electrician or Residential Contractor Registration shall be made in writing to the Wisconsin Department of Safety and Professional Services.

9.30 VIOLATIONS; PENALTIES

E. Violations. No Person shall erect, use, occupy or maintain any Building in violation of any provision of this Code, or act contrary to any provision of this Code, or cause any violation of this Code to be committed. Each day of violation shall be considered a separate offense.

F. Penalties. Any Person violating any of the provisions of this Code, except for the provisions governing the administration or enforcement thereof, shall upon conviction be subject to a forfeiture of not less than Twenty-five (\$25.00) Dollars per day, nor more than Five Hundred (\$500.00) Dollars per day, together with the costs of prosecution; and, if in default thereof, shall be imprisoned for a period of not less than one (1) day, nor more than six (6) months in the County Jail, or until such forfeitures and costs are paid.

CODE OF GENERAL ORDINANCES, 2021 - KENOSHA, WISCONSIN

CHAPTER X ALCOHOL BEVERAGES

10.01 ADOPTION OF STATUTES

The provisions of Chapter 125 of the Wisconsin Statutes and also all acts amendatory thereof and supplementary thereto are adopted as a portion of this Chapter so far as applicable, except as otherwise provided by this Chapter.

10.011 DEFINITIONS

- A. All definitions found in Section 125.07, Wisconsin Statutes, are incorporated herein.
- B. Unless otherwise indicated, the definitions of the terms below are as follows:
 - 1. **City** - the City of Kenosha, Wisconsin;
 - 2. **Class "A" License** - see Section 125.25(1), Wisconsin Statutes;
 - 3. **"Class A" License** - see Section 125.51(2)(a), Wisconsin Statutes;
 - 4. **Class "B" License** - see Section 125.26(1), Wisconsin Statutes; and,
 - 5. **"Class B" License** - see Section 125.51(3)(a), Wisconsin Statutes.
 - 6. **"Class C" License** - see Section 125.51(3m), Wisconsin Statutes.
 - 7. **Clerk or City Clerk** - the City Clerk/Treasurer;
 - 8. **Committee** - the License/Permit Committee;
 - 9. **Conditional surrender** - whereby a license holder surrenders his/her license(s) to the City on the condition that the City grants a similar license(s) to a person designated by the license holder;
 - 10. **Council** - the Common Council for the City of Kenosha, Wisconsin;
 - 11. **Ordinances** - the Code of General Ordinances for the City of Kenosha, Wisconsin;
 - 12. **Provisional Operator's License** - see Section 125.17(5), Wisconsin Statutes.
 - 13. **Reserve "Class B" License** - see Section 125.51(4)(bm), Wisconsin Statutes.
 - 14. **Temporary Class "B" License** - see Section 125.26(6), Wisconsin Statutes.
 - 15. **Temporary "Class B" License** - see Section 125.51(10), Wisconsin Statutes.
 - 16. **Transfer** - See Section 125.04(12), Wisconsin Statutes.

10.015 CITY PARKS

A. Sale of Fermented Malt Beverages Authorized. Pursuant to §125.06(6), Wisconsin Statutes, the sale of fermented malt beverages is authorized at the Washington Municipal Golf Course Clubhouse by City employees, with the receipts from the sales thereof being deposited in the City Treasury.

B. Wholesalers. Fermented malt beverage wholesalers are authorized to sell fermented malt beverages to the Washington Municipal Golf Course which are authorized herein to sell fermented malt beverages.

C. Operator's Licenses. City employees who sell fermented malt beverages in any City Park are not required under State law to hold an Operator's License or be supervised by a licensed operator.

D. Responsible Beverage Server Course. City employees who sell fermented malt beverages in any City Park must have completed a responsible beverage server training course as described in Section 125.17(6), Wisconsin Statutes, or hold a valid Operator's License issued by the City of Kenosha.

CODE OF GENERAL ORDINANCES, 2021 - KENOSHA, WISCONSIN

10.02 LICENSE - FEES

The classes of licenses and fees therefor shall be as follows and it shall be unlawful for any person, party, firm or corporation to engage in said licensed activity without first having obtained the appropriate license therefor:

A. Intoxicating Liquor.

1. **"Class A" License.** The annual fee for a "Class A" License is Five Hundred (\$500.00) Dollars. Licenses may be granted which shall expire on the 30th day of June each year upon payment of such proportion of the annual license fee as the number of months, or fraction of a month, remaining until June 30th of each year bears to twelve. No application for such license shall be accepted unless accompanied by the appropriate fee in cash or certified check.

2. **"Class B" License.** The annual fee for a "Class B" License is Five Hundred (\$500.00) Dollars, and must be paid on or before the June 15th preceding the commencement of the license year. The holder may sell, deal and traffic in intoxicating liquors to be consumed by the glass only on the premises so licensed, and in the original package or containers, in multiples not to exceed four (4) liters at any one time, and to be consumed off the premises so licensed, except that wine may be sold in the original package or otherwise in any quantity to be consumed off the premises.

Licenses may be granted which shall expire on the 30th day of June of each year upon payment of such proportion of the annual license fee as the number of months, or fraction of a month, remaining until June 30 of each year bears to twelve.

3. **Reserve "Class B" License.** In addition to any fees prescribed in **A.2.**, the Clerk shall charge an additional Ten Thousand (\$10,000.00) Dollars prior to the issuance of a reserve "Class B" License.

4. **"Class C" License.** The annual fee for a "Class C" License is One Hundred (\$100.00) Dollars.

B. Fermented Malt Beverages.

1. **Wholesaler's License.** The fee for a Wholesaler's License is Twenty-Five (\$25.00) Dollars.
2. **Class "A" License.** The annual fee for a Class "A" License is Five Hundred (\$500.00) Dollars.
3. **Class "B" License.** The annual fee for a Class "B" License is One Hundred (\$100.00) Dollars, which shall be payable on or before the 15th day of June of each license year.

C. Temporary Licenses.

1. **Temporary Class "B" License.** The fee for a Temporary Class "B" License is Ten (\$10.00) Dollars. This shall include the fee for a Temporary "Class B" License.

2. **Temporary "Class B" License.** The fee for a Temporary "Class B" License is Ten (\$10.00) Dollars.

D. Operator's [Bartender's] License.

1. **Regular Licenses.** The fee for an Operator's License shall be One Hundred (\$100.00) Dollars. Licenses shall expire on June 30th of every second year, following issuance.

2. Provisional Operators' License.

a. **Issuing Official.** A Provisional Operators' License shall be issued by the City Clerk/Treasurer to any applicant satisfying the conditions herein.

b. **Conditions of Issuance.** A Provisional Operators' License shall be issued to applicants who meet

CODE OF GENERAL ORDINANCES, 2021 - KENOSHA, WISCONSIN

the following requirements:

- (1) Applicant must have applied for, been granted, and be eligible for issuance of an Operator's License, except for the requirement of the completion of a responsible beverage server training course.
- (2) Applicant must show proof of enrollment in a responsible beverage server training course as required by §125.17(6), Wisconsin Statutes, and show course commencement and completion dates.
- (3) Applicant must have paid the Provisional Operators' License fee.
 - c. **Fee.** The fee for a Provisional Operators' License shall be Fifteen (\$15.00) Dollars.
 - d. **Expiration.** Provisional Operators' Licenses shall have the expiration date conspicuously placed thereon. The expiration date of the Provisional Operators' License shall be the date the beverage server training course is scheduled for completion, or sixty (60) days from the date of issuance, whichever is sooner.
 - e. **Revocation.** Provisional Operators' Licenses shall expire and be null and void on the date the Operators' License is revoked, should such event occur.
 - f. **Renewal.** One (1) Provisional Operators' License may be granted subject to one (1) renewal in the event the applicant, for good cause, is unable to timely complete the responsible beverage server training course in which he or she is enrolled.

E. Refunds. Refunds on "Class A", Class "A", "Class B", Class "B", and "Class C" Licenses shall be allowed and paid as follows:

- a. If the license is surrendered prior to its effective date, the whole fee paid shall be refunded.
- b. If the license is surrendered on or prior to three months after its first effective date, three-fourths (3/4) of the fee paid shall be refunded.
- c. If the license is surrendered on or prior to six (6) months after its first effective date, one-half (1/2) of the fee shall be refunded.
- d. No refund shall be allowed for the surrender of any license when such surrender occurs after six (6) months from the first effective date of such license.
- e. No refund shall be allowed for any Class "B" License that is granted for a six (6) month period or less.

10.03 LICENSE INVESTIGATION

A. Application. Application for any license provided for in this Chapter shall be made to the City Clerk in writing, accompanied by the required fee. Application shall be on City forms, shall be true, correct and complete in all respects, and shall define all areas and rooms to be licensed.

A separate application must be filed with the City Clerk for an Outdoor Extension of a Retail "Class B" and/or Class "B" License and no such Outdoor Extension shall be valid where reference thereto is made in a standard application form, even if said application is granted.

B. Operators and Agents Inspection and Recommendation. Applications for agent status or Operator's Licenses shall be referred by the City Clerk to the Police Department. The Police Department shall make a report, in writing, to the City Attorney as to any police record of the applicant which may reflect upon good moral character or business responsibility. The City Attorney shall examine said record and make a recommendation to the Committee on Licenses/Permits based thereon as to whether the license should be granted or agent status approved. In the event the application is determined to be untrue, incorrect or incomplete upon review by the City Attorney, the application shall be denied. Said Committee shall recommend to the Common Council either the granting or denial of the application.

C. Retail and Wholesale Establishments.

1. Upon receipt of an application for a new Retail Class "A", Class "B", "Class B" or "Class C" License or combination thereof or Wholesale License, or transfer of any such license under Section

CODE OF GENERAL ORDINANCES, 2021 - KENOSHA, WISCONSIN

125.04(12)(a), Wisconsin Statutes, the City Clerk/Treasurer shall send copies thereof to the Department of City Development, Department of City Inspections, the Fire Department, the Health Department, and Police Department. The Department of City Development, the Department of City Inspections, the Fire Department, and Health Department, either jointly or severally, within ten (10) days of receiving such copies, shall make a report, in writing, to the Committee on Licenses/Permits, as to whether the premises meet the requirements of this Chapter and the Building, Zoning, Fire, and Health Codes. The Police Department shall report, in writing, to the City Attorney as to any police record of the applicant for a new license (not a statutory transfer of a license), which may reflect upon good moral character or business responsibility. The City Attorney shall examine said record and make a recommendation to the Committee on Licenses/Permits based thereon as to whether or not the license should be granted.

2. Along with any application for a Class "B" or "Class B" License or combination thereof, or transfer of any such license under Section 125.04(12)(a), Wisconsin Statutes, the applicant shall file with the City Clerk/Treasurer an Economic Impact Statement estimating the impact of the license, if issued, upon the City economy. The Economic Impact Statement shall identify the ownership, value, and square footage of the premises to be licensed; estimate the number of persons to be employed full time and the number of persons to be employed on a part time basis; estimate the gross monthly revenue by each of the following categories: "alcoholic beverages", "food", "other"; and the basis for all estimates given. The information submitted shall be true, correct and complete in all material respects. Should the license be granted, or transferred and issued, and the licensee fails to achieve a minimum of seventy (70%) percent of the gross revenue estimated by applicant during the first full license term from the date the license is granted or transferred, the license may be suspended, revoked or not renewed. This paragraph shall not apply to renewals of existing licenses, after the first full license year, or to conditional surrenders of existing licenses, coupled with a new application for a license at the same location.

3. The Committee on Licenses/Permits shall review the application, the reports of the departments, the recommendation of the City Attorney, the Economic Impact Statement, if one is required, and all other information before it and make a recommendation to the Common Council.

4. In determining whether a new Class "A", Class "B", or "Class B" License or combination thereof should be granted, or transfer of such license approved, the Common Council shall consider the following factors giving to each whatever weight is appropriate in the particular factual circumstances:

a. Whether the applicant meets statutory and City licensing requirements and the premises to be licensed being in compliance with all applicable City Zoning and General Ordinances.

b. Whether the proposed development will have a substantial negative impact upon the surrounding properties or the neighborhood within six (6) blocks of the licensed premises, in terms of lowering property values, increasing noise, as defined in Chapter 23 of the General Ordinances, or traffic congestion, or otherwise have a negative effect on the existing or planned character of the neighborhood.

c. Whether there is an over concentration of licensed establishments in the neighborhood within six (6) blocks of the licensed premises.

d. Whether the operation of licensed premises will have a significant, positive influence on the City economy. In determining significant, positive influence on the City economy, the Common Council may consider the number of licenses available and the advisability of holding a license for possible future development.

e. Any other facts which reasonably relate to the public safety and welfare, or the legitimate police power of the City.

5. Where a license is granted or transferred following review of an Economic Impact Statement, the economic impact of the licensed premises shall be reviewed by the Committee on Licenses/Permits at the license application renewal review following the first full license year.

6. A "Class C" License may be issued to a person qualified under Section 125.04(5), Wisconsin Statutes, for a restaurant in which the sale of alcohol beverages accounts for less than fifty (50%) percent of gross receipts, and which does not have a barroom or for a restaurant in which the sale of alcohol

CODE OF GENERAL ORDINANCES, 2021 - KENOSHA, WISCONSIN

beverages accounts for less than fifty (50%) percent of gross receipts and which has a barroom in which wine is the only intoxicating liquor sold. A "Class C" License may not be issued to a foreign corporation, a foreign liability company or a person acting as agent for or in the employ of another.

D. Retail "Class A" Liquor Licenses.

1. Upon receipt of an application for a new Retail "Class A" License, or transfer of any such license under Section 125.04(12)(a), Wisconsin Statutes, the City Clerk/ Treasurer shall send copies thereof to the Department of City Development, the Department of City Inspections, the Fire Department, the Health Department, and Police Department. The Department of City Development, the Department of City Inspections, the Fire Department, and Health Department, either jointly or severally, within ten (10) days of receiving such copies, shall make a report, in writing, to the Committee on Licenses/Permits, as to whether the premises meet the requirements of this Chapter and the Building, Zoning, Fire, and Health Codes. The Police Department shall report, in writing, to the City Attorney as to any police record of the applicant for a new license (not a statutory transfer of a license), which may reflect upon good moral character or business responsibility. The City Attorney shall examine said record and make a recommendation to the Committee on Licenses/Permits based thereon as to whether or not the license should be granted.

2. The Committee on Licenses/Permits shall review the application, the reports of the departments, the recommendation of the City Attorney, and all other information before it and make a recommendation to the Common Council.

3. In determining whether a new "Class A" License should be granted, or transfer of such license approved, the Common Council shall consider the following factors giving to each whatever weight is appropriate in the particular factual circumstances:

a. Whether the applicant meets statutory and City licensing requirements and the premises to be licensed being in compliance with all applicable City Zoning and General Ordinances.

b. Whether the proposed development will have a substantial negative impact upon the surrounding properties or the neighborhood within 5,280 feet of the licensed premises, in terms of lowering property values, increasing noise, as defined in Chapter 23 of the General Ordinances, or traffic congestion, or otherwise have a negative effect on the existing or planned character of the neighborhood. In determining substantial negative impact, the Common Council shall consider whether the licensed premises has parking pursuant to the parking and loading requirements contained within Section 6.0 of the Zoning Ordinance for the City of Kenosha, and whether the licensed premises is consistent with any applicable neighborhood and/or zoning plan on file with the Department of City Development.

c. Whether there is an over concentration of licensed establishments in the neighborhood within 5,280 feet of the licensed premises. In determining whether there is an over concentration of licensed establishments, "over concentration" shall mean more than ten (10) "Class A" or "Class B" establishments within 5,280 feet of the licensed premises in a residential district and more than fifteen (15) "Class A" or "Class B" establishments in a business district. Residential district shall include zoning districts RR-1, RR-2, RR-3, Rs-1, Rs-2, Rs-3, Rd, Rg-1, Rg-2, Rm-1, Rm-2 and Rm-3 as defined by Section 3 of the Zoning Ordinance for the City of Kenosha, Wisconsin. Business district shall include business districts B-1, B-2, B-3 and B-4 as defined by Section 3 of the Zoning Ordinance for the City of Kenosha, Wisconsin.

d. Whether the operation of licensed premises will have a significant, positive influence on the City economy. In determining significant, positive influence on the City economy, the Common Council may consider the number of licenses available and the advisability of holding a license for possible future development, whether shelf space dedicated to "Class A" liquor products exceeds 1,000 square feet, if the projected gross revenue from "Class A" products exceeds Ten Thousand (\$10,000.00) Dollars per month, and whether a business plan has been submitted by the applicant with their application.

e. Whether the area where "Class A" beverages are stored or displayed on "Class A" premises can be physically closed to customers on the premises during the hours that the sale of "Class A" beverages are not permitted.

f. Whether the applicant, prior to filing its original application with the City Clerk, has notified the

CODE OF GENERAL ORDINANCES, 2021 - KENOSHA, WISCONSIN

Alderman for the district in which the proposed business is to be located that an application for a new "Class A" License will be submitted for consideration.

g. Any other facts which reasonably relate to the public safety and welfare, or the legitimate police power of the City.

4. Where a license is granted or transferred following review of an Economic Impact Statement, the economic impact of the licensed premises shall be reviewed by the Committee on Licenses/Permits at the license application renewal review following the first full license year.

10.04 RESTRICTIONS

The issuance of licenses shall be restricted as follows:

A. Location. See §125.68(3), Wisconsin Statutes.

1. No "Class B" and/or Class "B" License shall be granted for any premise not located on the street level, but this Section shall not apply to:

a. A bone fide "club" means an organization, whether incorporated or not, which is the owner, lessee or occupant of a building or portion thereof used exclusively for club purposes, which is operated solely for recreational, fraternal, social, patriotic, political, benevolent or athletic purpose but not for pecuniary gain and which only sells alcohol beverages incidental to its operation.

b. A "hotel" means a hotel defined in Wis. Stats. Sec. 97.01(7), that is provided with a restaurant.

c. A "bowling alley" means a facility where the sport of bowling as played as the primary activity.

d. A "banquet hall" means an establishment that is leased on a temporary basis before the event by individuals or groups who reserve the facility to accommodate private functions, including but not limited to banquets, weddings, anniversaries, receptions, business and organizational meetings, or other similar functions, in which the general public is not admitted and for which no admission charge is imposed.

2. No "Class A" License shall be granted for any premise not located on the street level.

B. Persons.

1. No license shall be granted to any person who does not meet the minimum requirements imposed by the Wisconsin Statutes.

2. Applicants shall not be required to show proof of or offer of employment as a condition of receiving any said license.

C. Limitation as to Number.

1. No more than one hundred seventy (170) Class "B" Licenses shall be granted.

2.a. No more than one hundred fifty-three (153) "Class B" Licenses shall be granted.

b. No more than twelve (12) Reserve "Class B" Licenses shall be granted. If the population of the City increases after December 1, 1997, one (1) license per every additional five hundred (500) persons, or fraction thereof, shall be added to this quota.

3. In the event of an annexation of a "Class A", Class "A", "Class B", Class "B", or any combination

CODE OF GENERAL ORDINANCES, 2021 - KENOSHA, WISCONSIN

thereof, or any "Class C" Licensed premises, the business may continue under the license(s) issued by the previous municipality until the next renewal date. At that time, the licensee may be granted the appropriate license(s), if they qualify under State law and local ordinances, notwithstanding the above quotas. Applicable quotas shall be expanded at the time the annexed business(es) receive their license(s) from the City, if the particular appropriate license(s) is(are) of quota.

4. The Common Council may grant a license to an applicant who has procured the conditional surrender of another such license, provided the licensee who is surrendering the license is not indebted to any licensed wholesaler in violation of the credit restriction set forth in §§125.33 (7) and 125.69 (4), Wisconsin Statutes, and that said licensee is not indebted to the City of Kenosha for any delinquent Personal Property Tax.

a. Conditional License surrenders shall not be made contingent upon the payment of any liquor or fermented malt beverage bills where credit therefor was extended beyond the respective thirty (30) and fifteen (15) day credit restrictions specified in §§125.33 (7) and 125.69 (4), Wisconsin Statutes.

b. A license(s) may be conditionally surrendered where the licensee who is surrendering the license(s) is indebted to a licensed wholesaler in violation of the credit restriction set forth in §§125.33 (7) and 125.69(4) of the Wisconsin Statutes where the indebtedness has been discharged in bankruptcy.

c. Bills which need not be paid as a condition of acceptance of a conditional surrender are those owing by the surrendering licensee to a given liquor or fermented malt beverage wholesaler where that particular wholesaler extended credit to said surrendering licensee beyond the respective fifteen (15) and/or thirty (30) day periods of time provided for as credit restrictions in applicable State law.

d. Other bills which need not be paid as a condition of acceptance of a conditional surrender of a license are those for credit provided by a wholesaler who, before providing credit, was notified in writing, served by registered or certified mail, return receipt, or personal service verified by an Affidavit of Service, that credit for the purchase of liquor and/or fermented malt beverages was contrary to the terms of a "Class A", Class "A", "Class B", Class "B" or "Class C" License Holder's land contract, lease, mortgage, bank note or court order. It shall be the duty of the person or party disputing such bills to produce relevant documents supporting the disallowance of such bills to the City Clerk's Office in a timely fashion.

5. Regarding Wholesalers, the following shall apply:

a. Wholesalers doing business in the City of Kenosha; who are lawfully operating within the City, and who are not licensed by the City, are required to register the trade name, address and telephone number of their firm with the City Clerk as a condition of their unpaid bills being processed by the City Clerk under the provisions of this Ordinance. This condition, however, shall not be applicable to the extent that it conflicts with any State law to the contrary.

b. Wholesalers desiring to submit outstanding bills to the City Common Council for consideration under this Ordinance must file their request for such consideration on City approved forms, having attached thereto a copy of all relevant original invoices, prior to the Committee's review of the license application.

c. Should a dispute arise as to whether any invoice(s) must be paid as a condition of a conditional surrender of license, the City Clerk may accept a cash bond, submitted on a City form, in the amount thereof. The person or party who is responsible for the payment of the disputed invoice(s), to be eligible to file a cash bond, must designate the City Clerk as his/her agent with full authority to make a binding and final determination as to whether or not said invoice(s) must be paid as a condition of a conditional license surrender, and to disburse or return the posted money. However, under no circumstances will the City Clerk be obligated to look behind the face of a submitted invoice.

d. The City Clerk shall notify the party posting such cash bond and any wholesaler having an interest in an unpaid, disputed invoice, of his/her intended disposition of said cash bond ten (10) days in advance of such disposition. Notice may be by first class mail. Should any interested party commence litigation to challenge such intended disposition within said ten (10) day period of time, the City Clerk shall hold the cash bond without disbursing such portion of said cash bond as is relative to said litigation until receipt of a court order directing such disbursement. The City Clerk may issue a Class "B", "Class B" and/or "Class C" License which has been granted by the Common Council where the only impediment to such issuance

CODE OF GENERAL ORDINANCES, 2021 - KENOSHA, WISCONSIN

is an outstanding invoice herein relevant, where a cash bond has been posted.

6. If an alcohol beverage licensee or applicant dies during a license term or the pendency of an application, the rules and procedures of Section 125.04(12), Wisconsin Statutes, shall apply.

D. Separation of Intoxicating Liquor and Fermented Malt Beverage Business From Other Business.

1. Except in case of hotels as defined in §125.02 (7) of the Wisconsin Statutes, a "Class A" License and a Class "B" and/or "Class B" License shall not both be issued for the same or connecting premises.

2. No business under a "Class A" License, or under a combination of a "Class A" License and a Class "A" License, shall be conducted in conjunction with any other business on the same premises unless:

The area in which the liquor and/or beer is sold shall be arranged and constructed in a manner as to permit and facilitate its closing during the hours and days in which fermented malt beverages may not be sold as stipulated by the Wisconsin Statutes.

Notwithstanding the proceeding paragraph, a business may maintain "end cap" displays of fermented malt beverages and wine at room temperature during the closing hours and days stipulated by the Wisconsin Statutes.

10.045 WITHHOLDING OF ISSUANCE OF LICENSES

See Section 1.045 of the Code of General Ordinances.

10.048 TEMPORARY "CLASS B" AND CLASS "B" LICENSES - APPLICATIONS

A. City application forms for Temporary Class "B" Licenses must be filed with the Office of the City Clerk no later than one (1) day prior to the day upon which the Common Council will consider and act upon said application for events lasting less than four (4) days and at least fifteen (15) days prior to the granting of the License for events lasting four (4) or more days. City application forms for Temporary "Class B" Licenses must be filed with the Office of the City Clerk at least fifteen (15) days prior to granting of the License.

Not more than 12 Temporary Class "B" Licenses may be issued to an applicant in any 12-month period. Not more than two Temporary "Class B" Licenses may be issued to an applicant in any 12-month period. A temporary license is valid for the day, or consecutive days, up to five (5), that the specified event is in progress.

B. Review. Temporary "Class B" and Class "B" Licenses will not be reviewed by the Committee, but will be reviewed by the City Attorney, or his/her designee, prior to Council action thereon. Council Agenda shall have a general heading of "Temporary "Class B" and Class "B" Licenses". Only license applications approved by the City Attorney, or his/her designee, as being in compliance with all applicable Federal, State and local laws will be submitted to the Council for approval as a matter of course. However, any applicant desiring to appeal the City Attorney's, or designee's ruling to the Council may do so by filing a written Notice of Appeal with the City Clerk. Appeals may be acted upon by the Council under the general heading on the Council agenda relative to Temporary "Class B" and Class "B" Licenses.

CODE OF GENERAL ORDINANCES, 2021 - KENOSHA, WISCONSIN

10.049 WITHDRAWAL OF LICENSE APPLICATION

A. Withdrawal of License Application. At any time prior to the final disposition by the Common Council of an application for a license under this Chapter, the applicant may withdraw the application. The withdrawal shall have the effect of removing the application from consideration by the Common Council. The administrative charge under Section 1.225 of the Code of General Ordinances shall be applicable.

B. Procedure for Withdrawal of License Application. The withdrawal of a license application shall be:

1. In writing.
2. Signed by the applicant. In the case of a general partnership, it shall be signed by all partners; in the case of a limited partnership, it shall be signed by the general partners; in the case of a corporation, it shall be signed by an officer of the corporation; in the case of a limited liability company, it shall be signed by the managing member.
3. Filed with the City Clerk.

C. Effective Date. Unless specifying a later effective date on its face, a withdrawal of a license application is effective upon receipt of the written document for filing by the City Clerk. Once filed, the withdrawal is irrevocable, regardless of whether it is intended to take immediate or future effect.

10.05 REGULATIONS

All licenses shall be granted subject to the following regulations.

A. Health Rules. All licensed premises shall be kept sanitary and shall be conducted in compliance with whatever health rules the Director of Health may prescribe.

B. Inspection and Search. Every licensee consents upon issuance of the license to the inspection and search by the Police Department of the licensed premises during business hours, and further consents to the removal of all articles found in violation of law or Ordinance and their subsequent introduction into evidence in any prosecution arising therefrom.

C. Employees.

1. No proprietor of any premises operating under a "Class B" and/or Class "B" License shall employ any person not allowed by any Federal or State Statute, rule or regulation.

2. It shall be unlawful for the Licensee, his agent or employee to be under the influence of an intoxicant, a controlled substance or combination of intoxicant and controlled substance while performing services on the licensed premises. Under the influence means that the person has consumed a sufficient amount of alcohol, controlled substance or combination of alcohol and controlled substance, to cause the person to be less able to exercise clear judgment and reasonable care in the exercise of services performed. Violations shall be limited to the offending person.

3. It is the affirmative duty of a Licensee, his agent and employees to answer fully and truthfully all questions of an identified police officer who inquires or investigates concerning persons or events in or around the licensed business; to cooperate with the police in any such inquiry or investigation, including the giving of oral or written statements to the police at reasonable times and locations in the course of investigations. Violations shall be limited to the offending person.

CODE OF GENERAL ORDINANCES, 2021 - KENOSHA, WISCONSIN

D. Conduct. It shall be unlawful for a licensee, his agent or employee, to permit the following conduct on licensed premises:

1. The performance of acts, or simulated acts, of "sexual intercourse, masturbation, sodomy, bestiality, oral copulation, flagellation or any sexual acts which are prohibited by law";
2. The actual or simulated "touching, caressing or fondling on the breast, buttocks, anus, or genitals";
3. The actual or simulated "displaying of the pubic hair, anus, vulva or genitals";
4. The permitting by a licensee, his agent or employee, or "any person to remain in or upon the licensed premises who exposes to public view any portion of his or her genitals or anus";
5. The displaying of films or pictures depicting acts a live performance of which was prohibited by the regulations quoted above.

E. Liquor Delivery. No wholesaler shall deliver intoxicating liquor between 7 p.m. on Saturday and 6 a.m. the following Monday or between 7 p.m. and 6 a.m. on any other day.

F. No "Class B" and/or Class "B" Licensee shall display any liquor or beer except on wall shelving, the back bar, or floor.

G. Operational Requirements.

1. Within ninety (90) days from the granting of a "Class A", Class "A", "Class B", or Class "B" License, or any combination thereof, the licensee shall be open for business with stock and equipment. In the event of the licensee's failure to be open for business within such time, said license or licenses shall be subject to revocation by the Common Council after a public hearing. The Committee on Licenses/Permits may, for good cause shown, extend said ninety (90) day period.

a. The above requirement to be open for business within ninety (90) days may be extended to one hundred eighty (180) days by the Common Council at the time the license or licenses are granted if all of the following conditions have been met:

- (1) at the time of application, the real property sought to be licensed does not have a permanent structure on it; and,
- (2) at the time of application, the real property sought to be licensed is either owned by the applicant, or is under lease to the applicant for a period greater than one (1) year from the date of application, or is subject to an accepted offer to purchase, whether or not conditioned on a future event. The deed, lease, or offer to purchase must be presented to the Committee on Licenses/Permits for review at the time it is reviewing the application; and,
- (3) at the time of application, the applicant submits a floorplan for the structure intended to be constructed on the real property, said floor plan specifying that portion of the structure which is to be licensed; and,
- (4) the applicant agrees in writing, as part of the application, to submit to the Committee on Licenses/Permits within ninety (90) days of granting of the license or licenses, a copy of the Building Permit and, if the applicant is not the owner or lessee of the property at the time of the application, a copy of the deed showing present ownership of the real property by the applicant; and,
- (5) the applicant agrees in writing, as part of the application, to be diligent in all efforts to get the structure built and stocked within one hundred eighty (180) days of the granting of the license.

b. The Committee on Licenses/Permits may extend the one hundred eighty (180) day period by a period of time to be determined by the Committee in its sound discretion where the following conditions have been met:

CODE OF GENERAL ORDINANCES, 2021 - KENOSHA, WISCONSIN

- (1) the licensee has complied with Subparagraphs **a. (1) - (5)**; and,
- (2) the applicant shows a need for the extension that did not arise out of a lack of diligence to satisfy any requirements contained in this Section.

c. If at any review hearing held before it, the Committee on Licenses/Permits is satisfied that any of the conditions in Paragraphs **a.** and **b.** of this Section have not been met, the Committee may commence a Revocation Hearing pursuant to the procedures contained within this Chapter.

2. Suspension or Cessation of Being Open for Business. If any licensee shall suspend or cease being open for business for a period of ninety (90) consecutive days or more, their "Class A", Class "A", "Class B", or Class "B" License, or any combination thereof, shall be subject to revocation by the Common Council after a public hearing.

3. "Open for Business" shall mean to operate as a licensed establishment for a minimum of forty-eight (48) hours per calendar month.

4. "Permanent Structure" shall mean a building, intended to be the licensed premise that would qualify for a Temporary Occupancy Permit pursuant to Section 8.0 of the City of Kenosha Zoning Ordinance.

H. Intoxicating liquor and fermented malt beverages may not be consumed by patrons or others outside of licensed Class "B" and/or "Class B" premises, as said premises are described in the relevant license application, and it shall be unlawful for a license holder to permit said consumption contrary to the terms of this Ordinance.

I. Regulation of Class "B"/"Class B" Premises. A Class "B" or a "Class B" licensed premises shall be operated in accordance with the following regulations:

1. Premises shall be equipped for retail sales of alcohol beverages for consumption on the premises with the following:

a. a serviceable bar or counter over which alcohol beverages in open containers may be served. This requirement shall not apply to restaurants, as defined in Section 254.61(5), Wisconsin Statutes, licensed by the State of Wisconsin.

b. glassware or other reusable utensils by means of which alcohol beverages may be served and consumed; and,

c. ice dispenser; and,

d. alcohol beverages to be offered for sale for consumption on the premises.

2. Licensees may not keep on premises any poisonous or toxic materials except where necessary for maintaining the establishment, cleaning and sanitizing equipment and utensils, and controlling insects and rodents.

3. Licensees shall keep complete and accurate records of all liquor or malt beverages purchased, sold, manufactured, rectified, brewed, fermented, distilled, produced, stored, warehoused, imported or transported by the Licensee at the licensed premises.

J. Drive Through Window Regulation.

1. Applicability. This Subsection shall apply to all establishments licensed pursuant to, and all licensees subject to this Chapter that provide retail sales of alcohol beverages through any opening connecting the interior of a structure to the exterior of a structure.

CODE OF GENERAL ORDINANCES, 2021 - KENOSHA, WISCONSIN

2. Still-Photo Camera Requirement. All establishments subject to this Subsection shall have a camera or cameras in operation at all times that sales are made through an opening that connects the interior of the structure to the exterior of the structure, that photographs the driver of the motor vehicle in which the patron is situated at the time of sale and the license plate of the motor vehicle.

3. Video/Audio Camera. In addition to the requirement of Paragraph **2**, all establishments subject to this Subsection shall have at least one (1) camera in operation at all times that sales are made through an opening that connects the interior of the structure to the exterior of the structure, capable of recording in video and audio format the interaction between the seller of the alcohol beverage and the purchaser of the alcohol beverage.

4. Operation. The licensed operator responsible for the sale of alcohol beverages made through an opening that connects the interior of the structure with the exterior of the structure shall assure cameras required under Paragraphs **2** and **3** herein are in operation at all times that sales are made.

5. Maintain Records. All image and audio recordings made pursuant to this Section shall be maintained by the licensee of the establishment licensed pursuant to this Chapter, for a period of no less than ninety (90) days, organized in a manner allowing for retrieval and copying at the request of a law enforcement officer.

6. Signage. All establishments subject to this Section shall have signs informing patrons of the following:

- a. They and their passengers are subject to being photographed.
- b. It is illegal for the purchaser of alcohol beverages to consume alcohol beverages or maintain alcohol in opened packages, on public thoroughfares or in the parking lot of the licensed establishments.

10.062 CONDITIONAL SURRENDER WHERE REVOCATION OR SUSPENSION PROCEEDINGS THREATENED OR COMMENCED

A. Voluntary Surrender. A Class "A", "Class A", Class "B", "Class B" or "Class C" License may be surrendered when any proceeding has been commenced by any authorized person or party to revoke or suspend such License. If the complaint in any such proceeding is found to be true, the License shall either be suspended for not less than 10 days nor more than 90 days or revoked.

B. Conditional Surrender. A Class "A", "Class A", Class "B", "Class B" or "Class C" License may not be conditionally surrendered when any proceeding has been commenced by any authorized person or party to revoke or suspend such License or when any proceeding is authorized by the License/Permit Committee or Common Council to revoke or suspend such license.

A Class "A", "Class A", Class "B", "Class B" or "Class C" License which is in jeopardy due to an actual or threatened license revocation proceeding may be surrendered on the condition that the owner of the licensed premises be granted a similar license at the same location where the license holder leases the premises or holds the premises under a land contract, subject to the following terms and conditions:

1. The License has not been revoked following a lawful revocation hearing.
2. The Licensee surrenders the License and the owner of the premises applies for said License.
3. License fees will not be prorated.

CODE OF GENERAL ORDINANCES, 2021 - KENOSHA, WISCONSIN

4. A similar License at the same location has not been conditionally surrendered while under threat of revocation within the past ten (10) years.

5. The license holder does not profit from the License transfer.

6. The license holder agrees in writing to:

a. never again be involved, directly or indirectly, in or have any financial interest in the licensed premises.

b. not apply for any Class "B" and/or "Class B" License or Operator's License for a period of five (5) years.

c. reimburse the City any out-of-pocket costs, if any, incurred in its commencement of a revocation proceeding.

10.063 POLICY & PROCEDURE FOR DISCIPLINARY ACTION RELATIVE TO ALL CLASS "A"/"CLASS A", CLASS "B"/"CLASS B" LIQUOR AND/OR FERMENTED MALT BEVERAGE LICENSES, AND "CLASS C" WINE LICENSE, OPERATOR'S LICENSES, AGENTS AND OTHER LICENSES AND PERMITS AUTHORIZED IN CHAPTER X

A. Definitions.

1. **LICENSE** shall mean any Retail Class "A"/"Class A", Class "B"/"Class B", or "Class C" License, or Operator's License, or agent status, or any other License or Permit authorized in Chapter X (10) of the Code of General Ordinances.

2. **LICENSEE** shall mean the holder of a License.

B. License Investigations. The following may initiate requests for investigations before the Committee which may result in orders, suspensions, nonrenewals, delays in License issuance or revocation:

The Mayor;
The Common Council;
The Committee;
The State of Wisconsin;
An Alderman;
The Police Chief;
The City Attorney; and,
Any Resident of the City of Kenosha.

Requests for investigations shall be in writing, sent to the City Clerk and shall contain a brief statement of the alleged misconduct. The request shall be forwarded by the requesting party to the City Clerk who shall place said request on the Common Council Agenda for referral to the Committee or directly on the Committee Agenda with the permission of the Committee Chairperson. The City Clerk or the Committee Secretary shall order the Licensee to attend the Committee meeting at which said matter will be reviewed. Documents which form a basis for a request for an investigation shall be available for the inspection of the Licensee.

The Committee may reconsider any evidence or argument presented or made before it, whether or not obtained in or related to the written request for an investigation.

CODE OF GENERAL ORDINANCES, 2021 - KENOSHA, WISCONSIN

The Committee, upon requesting and receiving a recommendation from the City Attorney's Office, shall recommend to the Common Council:

1. That no action be taken where there is no factual or legal basis for action.
2. That the License be suspended, not renewed or revoked following Statutory notice and opportunity to be heard, where the criteria for such action in Subsection D. is met;
3. That an order be issued and served upon the Licensee requiring that certain action be taken as a condition of maintaining said License and providing notice that revocation may be the penalty for failure to strictly comply with the letter and spirit thereof; or,

C. License Review Upon Renewal Application. Any License which is the subject of renewal shall, prior to License expiration, be reviewed in accordance with the procedure for License investigation contained in Subsection B., and in accordance with such additional procedures as the Committee may require. License renewal applications which are granted, shall be granted subject to applicable demerit points, if any.

D. Criteria For License Revocation, NonRenewal Or Suspension of any Retail Class "B"/"Class B", or "Class C" License, or Operator's License, or Agent Status, or any other License or Permit authorized in Chapter X (10) of the Code of General Ordinances Unless otherwise specified in this Ordinance.

1. Any Retail Class "B"/"Class B", "Class C" or Agent Status Licensee who, holds a license subject to a one (1) year term, who within seven hundred thirty (730) consecutive days, equals or exceeds a total of one hundred (100) demerit points for the below described conduct committed by Licensee, or employee or agent thereof, whether or not charged and/or convicted, shall have their License subject to revocation, nonrenewal or suspension, within the discretion of the Common Council.

Notwithstanding the foregoing, no demerit points will be issued to a Licensee for the conduct of an employee or agent of the Licensee, if such conduct of the employee or agent was the first and only violation occurring for which Licensee would be liable within the three hundred sixty-five (365) days preceding the violation by employee or agent.

2.a. The Common Council may, but is not obligated to, revoke a license, with a term of one (1) year, issued hereunder upon the accumulation of one hundred (100) demerit points within seven hundred thirty (730) consecutive days, subject to the following. With respect to the first accumulation of one hundred (100) demerit points within said seven hundred thirty (730) consecutive days, the disciplinary action shall consist of at a minimum of a license suspension of ten (10) consecutive days, plus an assessment of seventy-five (75) demerit points. With respect to the second accumulation of one hundred (100) demerit points within said seven hundred thirty (730) consecutive days, the disciplinary action shall consist of at a minimum of a license suspension of thirty (30) consecutive days, plus an assessment of seventy-five (75) demerit points. With respect to a third accumulation of one hundred (100) demerit points within said seven hundred thirty (730) consecutive days, the disciplinary action shall consist of revocation.

b. The Common Council may, but is not obligated to, revoke a license, with a term of two (2) years, issued hereunder upon the accumulation of one hundred (100) demerit points within one thousand four hundred sixty (1,460) days, subject to the following. With respect to the first accumulation of one hundred (100) demerit points within said one thousand four hundred sixty (1,460) days, the disciplinary action shall consist of at a minimum of a license suspension of ten (10) consecutive days, plus an assessment of seventy-five (75) demerit points. With respect to the second accumulation of one hundred (100) demerit points within said one thousand four hundred sixty (1,460) days, the disciplinary action shall consist of at

CODE OF GENERAL ORDINANCES, 2021 - KENOSHA, WISCONSIN

a minimum of a license suspension of thirty (30) consecutive days, plus an assessment of seventy-five (75) demerit points. With respect to a third accumulation of one hundred (100) demerit points within said one thousand four hundred sixty (1,460) days, the disciplinary action shall consist of revocation.

3. Where a license has been suspended, the license, during the period of suspension, shall not be conditionally surrendered or transferred to another party or place.

4. In the event of license revocation, nonrenewal or suspension hereunder, the City Clerk shall, within ten (10) days of the disciplinary action, mail a report to the State Department of Revenue giving the name of the licensee, the address of the licensed premises and a full description of the discipline imposed.

5. Where a license is revoked hereunder, the revocation shall be recorded by the City Clerk and no other license issued under Chapter 125, Wisconsin Statutes, may be granted within twelve (12) months of the date of revocation to the person/party whose license was revoked. No part of the fee paid for any license so revoked may be refunded.

6. Demerit Points. Demerit points are not deemed a penalty hereunder. Demerit points are a means of tracking the performance of licensees under this Chapter. In determining the accumulated demerit points against a license, the City shall use the date each violation was committed as the basis for the determination. Demerit points shall be assigned pursuant to Appendix 10.063 - DEMERIT POINT SCHEDULE.

7. Discretionary Demerit Points: Nonscheduled offenses shall be the subject of such number of demerit points as designated by the Common Council, within its discretion.

8. Doubled Demerit Points. In determining the accumulated demerit points against a license, the demerit points for a violation occurring on a second date within 365 consecutive days of a prior violation of the same statute shall be assigned double the point assessment assigned in Appendix 10.063. Once assigned, points shall not be reduced

9. Offenses Not Considered. No offenses will be considered respecting new applications for demerit points if the date of the violation is more than five (5) years prior to the date of application, except a felony which is material to the licensed activity.

10. Demerit Point Appearance. During the course of a licensing term, if it is determined that a license has accumulated eighty (80) demerit points within three hundred sixty-five (365) consecutive days, the clerk shall issue licensee an order to appear before the Licensing/Permit Committee. Failure to appear as ordered shall result in the assessment of twenty (20) demerit points. The assessment dates shall be the date of the notice.

E. Criteria For License Revocation, Non Renewal or Suspension of any Class "A"/ "Class A" License or Agent Status.

1. Wisconsin Chapter 125 Review.

a. Any Licensee who, holds a Class "A"/"Class A" License or agent status who within three hundred sixty-five (365) consecutive days violates Wisconsin Statute Chapter 125 two (2) times, whether said violations are committed by Licensee, or employee or agent thereof, whether or not charged and/or convicted, shall have their License subject to mandatory suspension of thirty (30) days upon Common Council review.

CODE OF GENERAL ORDINANCES, 2021 - KENOSHA, WISCONSIN

b. Any Licensee who, holds a Class "A"/"Class A" License or agent status who within three hundred sixty-five (365) consecutive days violates Wisconsin Statute Chapter 125 three (3) times, whether said violations are committed by Licensee, or employee or agent thereof, whether or not charged and/or convicted, shall have their License subject to mandatory suspension of sixty (60) days upon Common Council review.

c. Any Licensee who, holds a Class "A"/"Class A" License or agent status who within three hundred sixty-five (365) consecutive days violates Wisconsin Statute Chapter 125 more than three (3) times, whether said violations are committed by Licensee, or employee or agent thereof, whether or not charged and/or convicted, shall have their License subject to mandatory non renewal or revocation upon Common Council review.

2. Any Licensee who, holds a Class "A"/"Class A" License or agent status who within seven hundred thirty (730) consecutive days, equals or exceeds a total of one hundred (100) demerit points for the below described conduct committed by Licensee, or employee or agent thereof, whether or not charged and/or convicted, shall have their License subject to revocation, non renewal or suspension, within the discretion of the Common Council.

Notwithstanding the foregoing, no demerit points will be issued to a Licensee for the conduct of an employee or agent of the Licensee, if such conduct of the employee or agent was the first and only violation occurring for which Licensee would be liable within the three hundred sixty-five (365) days preceding the violation by employee or agent.

3. The Common Council may, but is not obligated to, revoke a license, with a term of one (1) year, issued hereunder upon the accumulation of one hundred (100) demerit points within seven hundred thirty (730) consecutive days, subject to the following. With respect to the first accumulation of one hundred (100) demerit points within said seven hundred thirty (730) consecutive days, the disciplinary action shall consist of at a minimum of a license suspension of ten (10) consecutive days, plus an assessment of seventy-five (75) demerit points. With respect to the second accumulation of one hundred (100) demerit points within said seven hundred thirty (730) consecutive days, the disciplinary action shall consist of at a minimum of a license suspension of thirty (30) consecutive days, plus an assessment of seventy-five (75) demerit points. With respect to a third accumulation of one hundred (100) demerit points within said seven hundred thirty (730) consecutive days, the disciplinary action shall consist of revocation.

4. Where a license has been suspended, the license, during the period of suspension, shall not be conditionally surrendered or transferred to another party or place.

5. In the event of license revocation, nonrenewal or suspension hereunder, the City Clerk shall, within ten (10) days of the disciplinary action, mail a report to the State Department of Revenue giving the name of the licensee, the address of the licensed premises and a full description of the discipline imposed.

6. Where a license is revoked hereunder, the revocation shall be recorded by the City Clerk and no other license issued under Chapter 125, Wisconsin Statutes, may be granted within twelve (12) months of the date of revocation to the person/party whose license was revoked. No part of the fee paid for any license so revoked may be refunded.

7. **Demerit Points.** Demerit points are not deemed a penalty hereunder. Demerit points are a means of tracking the performance of licensees under this Chapter. In determining the accumulated demerit points against a license, the City shall use the date each violation was committed as the basis for the determination. Demerit points shall be assigned pursuant to **Appendix 10.063 - DEMERIT POINT SCHEDULE.**

CODE OF GENERAL ORDINANCES, 2021 - KENOSHA, WISCONSIN

8. Discretionary Demerit Points. Nonscheduled offenses shall be the subject of such number of demerit points as designated by the Common Council, within its discretion.

9. Doubled Demerit Points. In determining the accumulated demerit points against a license, the demerit points for a violation occurring on a second date within 365 consecutive days of a prior violation of the same statute shall be assigned double the point assessment assigned in **Appendix 10.063**. Once assigned, points shall not be reduced.

10. Offenses Not Considered. No offenses will be considered respecting new applications for demerit points if the date of the violation is more than five (5) years prior to the date of application, except a felony which is material to the licensed activity.

11. Demerit Point Appearance. During the course of a licensing term, if it is determined that a license has accumulated eighty (80) demerit points within three hundred sixty-five (365) consecutive days, the clerk shall issue licensee an order to appear before the Licensing/Permit Committee. Failure to appear as ordered shall result in the assessment of twenty (20) demerit points. The assessment dates shall be the date of the notice.

F. Discretion Upon Review. The Common Council is not mandated to revoke, not renew or suspend a License which is subject to revocation, nonrenewal or suspension based upon the criteria in Subsections D. or E.3., but may take such action as the circumstances warrant with due consideration for mitigating factors. However, where a suspension is imposed, the minimums specified in Subsections D. or E.3. are applicable.

A dismissal of a criminal charge or civil forfeiture case which is also the subject of demerit points, shall not, as a matter of law, nullify said charge for the purpose of review herein due to the differing burdens of proof and procedural requirements.

G. Delay in License Issuance. Any person or party who performs a licensed activity without first having obtained a proper License, or who, during a period of license suspension, or who, after License revocation or nonrenewal, unlawfully engages in a licensed activity, shall be barred from applying for the required License for a period of six (6) months from the date of such offense.

H. New Licenses Granted Subject to Demerit Points. New Licenses may be granted subject to such number of demerit points as the Common Council, in its discretion, may deem appropriate, irrespective of the nature of the offense, where the Common Council has concern as to the moral character and business responsibility of the applicant, which is insufficient for License denial.

New Licenses, if granted, shall be subject to twenty-five (25) demerit points in the event the License application acted upon is filed in violation of §1.22 A. of the Code of General Ordinances respecting untrue, incorrect and/or incomplete application, or in the event any License application was filed under this Chapter in violation of Section 1.22 A. of the Code of General Ordinances within six (6) months of the date of the license application acted upon.

I. Time for Action. Disciplinary action need not be commenced and completed in the same License year as the offense occurred. Where disciplinary actions are not commenced and completed within a License term, a License shall be granted subject to a "NonRenewal Revocation Hearing", to be held as soon as practicable.

J. Disciplinary Hearings. Disciplinary hearings, including nonrenewal, suspension and revocation hearings, shall be held before the Committee, which shall submit a report to the Common Council, including Findings of Fact, Conclusions of Law and a recommendation as to what action, if any, the

CODE OF GENERAL ORDINANCES, 2021 - KENOSHA, WISCONSIN

Common Council should take with respect to the License. The Committee shall provide the Complainant and the Licensee with a copy of the report. Either the Complainant or Licensee may make an objection, orally or in writing, to the report and shall have the opportunity to present arguments supporting the objection to the Common Council. At all stages of the proceedings before the committee or before the Common Council, the Licensee shall be entitled to appear in person or by any of the following representatives: its corporate officers, members, partners, the licensing agent on file with the office of the City Clerk or by an attorney. The Common Council shall determine whether the arguments shall be presented orally or in writing, or both. If the Common Council, after considering the Committee's report and any arguments presented by the Complainant and Licensee, finds the complaint to be true, or if there is no objection to a report recommending a suspension, revocation or nonrenewal, the Licensee shall be suspended, revoked or not renewed as provided by law. If the Common Council finds the complaint untrue, the proceedings shall be dismissed without cost to the accused. The City Clerk shall give notice of each suspension, revocation or nonrenewal to the party whose License is affected.

K. Judgment Of Conviction, As Prima Facie Proof of Violation. The judgment of conviction of any Licensee, or employee or agent thereof, in any Municipal, State or Federal Court, irrespective of whether obtained following trial, plea agreement, or bond forfeiture, shall be prima facie proof of said violation for purposes of this Ordinance. However, in the instance of any judgment of conviction entered pursuant to a no contest plea, or considered in law to be rendered pursuant to a no contest plea, said judgment of conviction as a prima facie case may be rebutted. Further, mitigating circumstances may be introduced with respect to any judgment of conviction.

L. Application For Determination of Demerit Points. Any Licensee or party entitled to initiate a request for an investigation under Subsection B. hereof, may, at any time, request the Common Council to determine whether or not conduct which has occurred constitutes a basis for demerit points, and, if so, how many demerit points. The Common Council, in making this determination, shall have before it the recommendation of the Committee and of the City Attorney's Office.

M. Commencement Of Penalties. Penalties shall commence the day after they have been imposed by the Common Council. Days of suspension shall run consecutively.

N. Periodic Reports By Police Chief. The Police Chief shall file periodic reports with the City Attorney advising said City Attorney of conduct by any Licensee, or employees thereof, which may constitute a basis for disciplinary action. The City Attorney, at License renewal time, or at any earlier time deemed appropriate, shall bring such matters to the attention of the Committee and make a recommendation on disciplinary action.

10.064 OFF LICENSED PREMISES CONDUCT OF PATRONS AND PERSONS AS A BASIS FOR DISCIPLINARY ACTIONS

A. Purpose. The purpose of this Ordinance is to protect the peace, tranquility and property values of the neighborhood in which a Class "A", "Class A", Class "B", "Class B", or "Class C" (if available) premise licensed under this Ordinance is located.

B. Responsibility of Licensee. Over and above the other provisions of this Chapter and Chapter 125, Wisconsin Statutes, every Class "A", "Class A", Class "B", "Class B", or "Class C" (if available) licensee licensed under this Chapter shall, during hours of operation of the licensed premises, be responsible for the conduct of patrons and persons who are not on the licensed premises, but are present on the following described off-licensed premises' property:

- Parking lot owned or operated by licensee which serves the licensed premises;

CODE OF GENERAL ORDINANCES, 2021 - KENOSHA, WISCONSIN

- The lot upon which the building being the subject of the license or parking lot serving the licensed premises is situated;

Examples of conduct which could form the basis for an order hereunder include, but are not limited to:

- Loitering where accompanied by loud noise, threats, fighting, open intoxicants, consumption of intoxicants, weapons use or display, illegal drug use or sale, urination, or otherwise disturbing, disorderly, or illegal conduct;
- Loitering of persons under the influence of alcohol beverage or drugs;

hereinafter "loitering". The licensee shall be responsible to monitor off-licensed premises property for compliance with this Ordinance. The licensee shall have a duty to direct patrons or persons engaged in loitering to immediately leave property. The licensee is not to use physical force to remove any such person or patron. Should notified persons and patrons fail to comply, licensee shall have an obligation to call the City Police Department for assistance. The licensee may elect to first call the Police Department if the licensee has concern for their safety. "Licensee" shall mean and include any person having control of the operation of the licensed premises.

C. Complaints. Complaints may be made by:

The Mayor;
The Common Council;
The Committee;
The State of Wisconsin;
An Alderperson;
The Police Chief;
The City Attorney; and,
Any Resident of the City of Kenosha.

Complaints shall be made in writing and filed with the City Clerk. The City Clerk shall direct the complaint to the Chair of the Committee. With respect to complaints of illegal drug use or sale, the City Clerk shall not direct the complaint to the Committee until first consulting with the Police Department and receiving a determination that the review of the complaint by the Committee will not interfere with a law enforcement investigation. The Chair shall review the complaint and any other documentation available to the Chair, including, but not limited to, police reports and statements of the complainant, licensee, or others, to determine whether the complaint has sufficient merit to be placed on the Committee agenda.

D. Committee Action on Complaint. The Committee shall order the licensee to appear before it to discuss the complaint and potential remedies. After hearing from the complainant, licensee and all interested parties, and reviewing all applicable reports, statements and documentation, the Committee shall have four (4) options:

1. No Action Taken. No action shall be taken on the complaint if it is unfounded, without merit, or if the alleged conduct is outside of the effective control of the licensee.

2. Oral Recommendations. Oral recommendations may be given from the Committee to the licensee on how the licensee could address the issues raised in the complaint.

3. Written Recommendations. If the Committee finds that the complaint has merit and that a reasonable remedy exists, the Committee may cause a written recommendation be sent to licensee through the U.S. mail, first class, postage prepaid. The written recommendation shall include the Committee's finding on the complaint, the remedies, the timetable and/or deadlines for compliance, and an order to appear back before the Committee on a specific date or dates to determine compliance with

CODE OF GENERAL ORDINANCES, 2021 - KENOSHA, WISCONSIN

directives. The only portion of the written recommendation which would subject the licensee to discipline for noncompliance is that portion ordering the licensee to appear before the Committee.

4. Orders. If the Committee finds the complaint has merit, and that a reasonable remedy exists, and that written recommendations are inappropriate or ineffective, the Committee may recommend to the Common Council that formal orders be issued by the Common Council. Unless otherwise stated, orders are permanent, unless rescinded, as long as the licensee maintains the same type of license at the location being the subject of the complaint. Orders may include, but are not limited to, the following remedial actions.

- Reduction in hours of operation of licensed premise
- Prohibition of the sale of carryout alcohol beverages;
- Establishment of specified security measures;
- Prohibition of loitering.

E. Common Council Action on Complaint. Upon recommendation by the Committee for written orders as provided herein, the Common Council shall order the licensee to appear before the Common Council. After meaningful opportunity for the licensee to be heard, the Common Council shall issue the order that it deems appropriate. Orders from the Common Council will be sent to the licensee at the address of the licensed premises by first class mail, postage prepaid.

F. Committee Review. After orders issued by the Common Council, the Committee shall conduct such reviews as it deems necessary and sufficient in order to monitor compliance by licensee with the orders. If at any review it appears to the Committee that the licensee is materially noncompliant, it may require the City Attorney to commence formal disciplinary proceedings for violation of the orders.

G. Violations. Violations of a final order of the Common Council, regardless of subsequent remedial measures, shall constitute grounds for disciplinary action, including a ten (10) day suspension per violation per each day of noncompliance.

10.07 CABARET LICENSE

A. Purpose. The purpose of this chapter is to regulate the operation of businesses that provide live entertainment to their patrons and which are licensed to serve alcoholic beverages for consumption so as to minimize the negative secondary effects and to preserve the public safety and health. When mismanaged, these establishments are known to present special problems of noise, boisterous conduct, fighting, or other disorderly conduct, thefts, littering, loitering, public congestion inside the premises, and outside the premises in adjacent parking areas, or other adjacent areas, illegal parking, and related problems arising out of the particular circumstances attendant to public congregations of this type. It is not the city's intent to regulate or restrict the type of content of entertainment provided in those establishments. All licensees will be responsible for controlling patron conduct at their establishment, making adequate provisions for security and crowd control, compliance with state and local laws and minimizing disturbances caused by the operation of the establishment.

B. License Required. No holder of a "Class B", Class "B" and/or "Class C" License shall perform, engage in, or permit, the following activity by employees, patrons, or hired performers upon the licensed premises without first having obtained a Cabaret License from the City Clerk:

1. Live music performances;
2. Specifically advertise or feature dancing; and,
3. Live entertainment, including, but not limited to, the performance of any act, play or stunt, amateur talent contest, or disc jockey show.

C. Application Requirements. Upon application to the City Clerk and the payment of the fee therefor, a Cabaret License will be considered subject to the conditions and regulations set forth in this Section.

CODE OF GENERAL ORDINANCES, 2021 - KENOSHA, WISCONSIN

1. Application. An application for a license provided for in this Section shall be made to the City Clerk in writing, accompanied by the required fee. Applications shall be on City forms; shall be true, correct and complete in all respects. No application for such license shall be accepted unless accompanied by the appropriate fee.

2. Security Plan. Applicants shall submit a security plan at the time of the application. An application will not be accepted for review and consideration without a plan. The plan must include:

- a.** The plan must set forth how the applicant will resolve issues regarding:
 - (1)** control and clearance of the parking lot and public right-of-ways adjacent to the licensed property during hours of operation and at closing time;
 - (2)** unruly patrons;
 - (3)** patrons who are intoxicated;
 - (4)** patrons presenting false IDs; and
 - (5)** Preventing the recurrence of any past disturbances or lapses in security of persons or property, which are reasonably analogous to the operation of a Cabaret License, attributable to either the Applicant or business establishment listed in the application.
- b.** The circumstances under which the police should be called.
- c.** The plan must identify by name the individuals who are employed by the establishment in a management capacity.

3. Operational Plan. Applicants shall submit an operational plan at the time of the application. An application will not be accepted for review and consideration without a plan. The plan must include:

- a.** Planned hours of operation for the premises.
- b.** Legal occupancy limit of the premises.
- c.** Description and number of off-street parking spaces used to service the premises.
- d.** Whether or not the premises will make use of sound amplification equipment.
- e.** Identify any sound mitigation strategies to be implemented.
- f.** Describe how the applicant will maintain the orderly appearance and operation of the establishment and area with respect to litter and noise.
- g.** Other pertinent information the License and Permit Committee or Common Council may from time to time require.

4. Required Contacts and Informational Session. No less than seven (7) days prior to the date the Alcohol License Review Committee first considers the application, the applicant shall contact the Alder for the district in which the premises is located. The applicant shall discuss their business plan and concept of operations with that Alder. No less than seven (7) days prior to the date the Alcohol License Review Committee first considers the application, the applicant is encouraged to also hold or attend an informational session with or host an open house for the local community to discuss their business plan and concept of operations. Members of the local community shall have the opportunity to ask questions of the applicant and state any concerns that they have with the application.

D. Review Procedure and Decision.

1. Schedule for Review. The Mayor shall cause an application for Cabaret License to be placed on a Common Council agenda such that it may be addressed by the Common Council within forty-five (45) days of receipt of the application. Within forty-five (45) days of receiving an application for a Cabaret License, the City Clerk shall notify the applicant whether the application is granted or denied. An application not reviewed by Common Council within forty-five (45) days shall be granted.

2. Review Discretion. The Common Council shall have the discretion to refuse the granting of any License if in its judgment the granting of such License shall be against the public interests as determined by consideration of the review standards contained herein.

3. Review Standards. In determining whether a Cabaret License should be granted, the Common Council shall consider the following factors, giving to each whatever weight is appropriate in the particular factual circumstances:

CODE OF GENERAL ORDINANCES, 2021 - KENOSHA, WISCONSIN

- a. **Impact.** Whether the proposed license will have a substantial negative impact upon the surrounding properties of the neighborhood within 5,280 feet of the licensed premises, in terms of increasing noise, as defined in Chapter 23 of the Code of General Ordinances, and/or traffic congestion.
- b. **Parking.** The availability and type of parking on or off the proposed licensed premises.
- c. **Neighborhood.** The existing or planned character of the neighborhood
- d. **Licensing Compliance.** Applicant's compliance and past performance with any/all licensing laws.
- e. **Proposed Security Plan.** Whether the proposed security plan shows a reasonable degree of advance consideration such as to mitigate the potential risks of disturbances or lapses in security of persons or property.
- f. **Prior Security History.** Prior history of disturbances or lapses in security of persons or property, which are reasonably analogous to the operation of a Cabaret License, attributable to either the Applicant or business establishment listed in the application.
- g. **Proposed Operational Plan.** Whether the proposed operational plan is considered appropriate for the proposed business and location.

E. License Term. A Cabaret License shall terminate as a matter of due course on the date the holders thereof cease to hold a "Class B", Class "B" and/or "Class C" License, without refund of any portion of the License fee therefore.

1. Probationary License. Upon the initial application for a license, made after enactment of this ordinance, and where the applicant has not held a license issued under the then existing city cabaret ordinance or when an applicant's most recent Cabaret License was revoked, only a Probationary License may be issued. A Probationary License granted under this section shall be for a period of six (6) months, and shall be subject to revocation as herein provided. Upon completion of the Probationary License period applicant shall be eligible to apply for an Annual License. No application for an Annual License will be accepted earlier than forty-five (45) days prior to the expiration of a valid Probationary Cabaret License.

2. Annual License. After an applicant has held a Probationary License for a period of six (6) months or an Annual Cabaret License was not revoked, an Annual License may be issued upon approval of an application and upon payment of such proportion of the annual fee as the number of months, or fraction of a month, remaining until June 30th of each year bears to twelve. The License shall expire on June 30th following its issuance. The License is a one (1) term license which is nonrenewable. A new Annual License application must be filed for review for each subsequent license term which will be considered pursuant to the terms of this ordinance.

3. One (1) Day License. A One Day License may be issued for one (1) day only. The One (1) Day License application shall designate the date the License will be utilized.

F. License Fees.

1. **Probationary License.** The Probationary License Fee shall be Three Hundred (\$300.00) Dollars.
2. **Annual Licenses.** The Annual License Fee shall be Three Hundred (\$300.00) Dollars.
3. **One (1) Day License.** The One (1) Day License fee shall be Fifty (\$50.00) Dollars.

G. Hours for Cabaret Entertainment. Effective July 1, 2021, Cabaret Entertainment shall not be permitted between the hours of 1:30 a.m. and 8:00 a.m. Should the proposed establishment not have a history of any disturbances covered under section D.3.f., this prohibition may be reduced to the hours of 2:00 a.m. and 8:00 a.m. Except that, on January 1, the applicable prohibition does not apply.

H. License Review and Recommendation. Applications for Probationary and Annual Licenses shall be referred by the City Clerk to the Police Department. The Police Department shall make a report, in writing, to the City Attorney as to any police record of the applicant, which may reflect upon good moral character or business responsibility. If the applicant has held a Cabaret License, the report should

CODE OF GENERAL ORDINANCES, 2021 - KENOSHA, WISCONSIN

include information relative to the investigation of any complaints received by the Police Department concerning the applicant and/or past compliance with the terms of this ordinance. The City Attorney shall examine said record and make a recommendation to the Committee on Licenses/Permits based thereon as to whether the license shall be granted. The Committee on Licenses/Permits shall review all applications, any reports, the recommendation of the City Attorney and all other information before it. Said Committee shall recommend to the Common Council either the granting or denial of each application. The Committee may recommend and the Common Council may impose additional conditions or restrictions on the Cabaret License use if the information on evidence available to and considered by the Committee and/or Council reasonably establish that such conditions or restriction to promote the review standards necessary to protect the health, safety and welfare of the surrounding neighborhood including but not limited to more restrictive hours of operation and noise prohibitions.

Applications for a One (1) Day License may be administratively approved by the City Clerk if the application is filed twenty-four (24) hours prior to the date for which the License is sought, not including weekends and holidays, commencing at 8:00 a.m. of the day following the date of which a properly completed application was filed with the City Clerk/Treasurer; if the application is sponsored by the Alderperson of the District in which the License will be located, or in the event that the Alderperson of the District is unavailable, sponsored by a member of the Committee on Licenses/Permits; and the Licensee/Applicant has not been issued a municipal citation for a violation of Chapter 10 of the Code of General Ordinances and/or Wisconsin Statute Chapter 125 within the three hundred sixty-five (365) days preceding the application date. Should the applicant not meet the preceding qualifications, the application shall be reviewed pursuant to the procedure applicable to Probationary and Annual Licenses.

I. Regulations.

1. Control of Premises. At no time may licensee relinquish control of the licensed premises or the service of alcohol to any other person or entity. The licensee must remain in control of the premises and must continue to be in control of the alcohol and service thereof through the licensee's own employees, including but not limited to checking identification of patrons, providing security within the licensed premises and at the door, collecting money or tickets from patrons for food, drinks, or for charges for entry to the establishment or any area within the establishment, during all events, including private parties. The licensee and its employees will be held responsible for all conduct taking place on its premises at all times including conduct taking place during private parties. Notwithstanding the limitations of this subdivision, a licensee may contract with an agency that is licensed by the State of Wisconsin as a supplier of uniformed private security personnel to engage in private security activities.

2. Lighting. While dancing is in progress, the dance area shall have a minimum average illumination level of no less than 2 foot candles, measured at the floor level.

3. Order. Good order shall be maintained at all times.

4. Cooperation with Police. The management shall obey all reasonable orders or directions of any police officer or official dance supervisor.

5. Parking. Adequate parking accommodations may be deemed necessary by the Police Department and/or Licensing/Permit Committee for safety reasons; lighted parking facilities may be maintained so as to accommodate anticipated capacities.

6. Performance. The performance of any act, stunt, or dance by performers under the auspices of the management shall be given only on a stage, platform or floor which is separated by a railing or other device from the patrons so as to deter patrons from participating in any act, stunt or dance. Patrons may not tip the entertainers or performers by placing money or other articles of value in their costumes, or otherwise engage in physical contact with the entertainers or performers.

7. Patron Participation. No license holder personally or through his agent or employee shall permit any patron to participate in any act, stunt, or dance with performers who are under the auspices or furnished by the management.

CODE OF GENERAL ORDINANCES, 2021 - KENOSHA, WISCONSIN

8. Patron Participation Exception. No patron shall participate in any act, stunt or dance by performers who appear under the auspices of the management, except upon written notification to the City Clerk and the Alderperson of the District at least seven (7) days in advance of the event, dance lessons are permitted. The Licensee shall provide separate notification for each date on which lessons will be offered. Lessons otherwise permitted by this Section are subject to an order to cease and desist by the Police Chief or his designee in the event in his determination there is a threat to the health, welfare or safety to patrons or other members of the community.

9. Lewd and Indecent Performance. No license holder personally, or through his agent or employee, shall advertise or produce lewd, obscene or indecent performance.

10. Regulation of Costumes. The top portion of the costume worn by female entertainers shall be of nontransparent material. It must encircle the body and the areola of the breast must be completely covered. The lower portion of the costume must completely cover the mons pubis and the cleavage of the buttocks. Male entertainers must wear a nontransparent costume covering the cleavage of the buttocks and the genitals.

11. Contest. No patron shall participate in any amateur striptease contest or wet T- shirt or similar contest.

12. Probationary and Annual License Framed, Posted.

a. Frame. All probationary and annual licenses shall be enclosed in a frame having a transparent front which allows the license to be clearly read.

b. Display. All probationary and annual licenses under **Paragraph a.** shall be conspicuously displayed for public inspection at all times in the room or place where the activity subject to licensure is carried on.

J. Administrative Suspension. Upon written request made and filed with the City Clerk/Treasurer of the City of Kenosha by the Chief of Police, the Mayor may immediately suspend any license issued under this Section. A written order of administrative suspension shall be served upon the Licensee. All licensed activities shall remain suspended until completion of an administrative review hearing. Upon administrative suspension, an administrative review hearing shall be scheduled for license review within ten (10) days pursuant to the terms of Subsection 10.07 H. of this Ordinance.

K. Revocation of License.

1. Upon written charges made and filed with the City Clerk/Treasurer of Kenosha by the Chief of Police or any citizen, the Council may after a public hearing thereof revoke any license issued under this Section.

2. Conviction for the violation of any provision of the Wisconsin liquor laws, City of Kenosha Code of General Ordinances, Zoning Ordinance or sanitary codes shall be sufficient for the Council to revoke or suspend such license. Additionally, filing an application which is subsequently determined to be untrue, incorrect or incomplete; or operating the business contrary to the submitted security or operational plans shall be sufficient cause for the Council to revoke or suspend such License. In the event the license is revoked, no other Cabaret License shall be granted to such person for said location within twelve (12) months of the date of its revocation. A suspension shall not be for less than ten (10) days, nor more than ninety (90) days from the date of suspension. Any part of the money paid for any license so revoked or suspended shall be forfeited and not be refunded.

3. The Common Council may, after the hearing described in 10.063 J., revoke such Cabaret License upon sufficient proof that the holder has permitted or suffered the licensed premises to be conducted by himself, his employees, patrons or others in violation of health regulations or in a disorderly or improper manner, or in violation of the laws of the State, or rules and regulations of the Common Council, or for any reasons set forth in Subsection 2.

CODE OF GENERAL ORDINANCES, 2021 - KENOSHA, WISCONSIN

L. Severability. Should any section, paragraph, sentence, clause or phrase of this Section be declared unconstitutional or invalid, or be repealed, it shall not effect the validity of the Ordinance as a whole or any part thereof other than the part so declared to be invalid or repealed.

10.074 OPEN CONTAINER ENTERTAINMENT EVENT

A. Definitions. The following terms and phrases, for purposes of this Ordinance, shall have the meanings provided:

1. **Alcoholic Beverages** shall mean all fermented malt beverages and intoxicating liquors.
2. **Fermented Malt Beverages** shall mean any beverage made by the alcohol fermentation of an infusion in potable water of barley malt and hops, with or without unmalted grains or decorticated and degerminated grains or sugar containing 0.5% or more of alcohol by volume.
3. **Intoxicating Liquor** shall mean all ardent, spirituous, distilled or vinous liquors, liquids or compounds, whether medicated, proprietary, patented or not, and by whatever name called, containing 0.5% or more of alcohol by volume, which are beverages, but does not include "fermented malt beverages."
4. **Licensed Premises** shall mean premises issued a Class "B" License pursuant to Chapter 10 of the General Code of Ordinances and Chapter 125 Wisconsin Statutes, a Brewer's Permit pursuant to Wisconsin Statute Section 125.29, or a temporary Class "B"/temporary "Class B" license issued pursuant to Chapter 10 of the General Code of Ordinances and Chapter 125 Wisconsin Statutes.
5. **Outdoor Open Container Entertainment Event** shall mean a public event in a defined area of the city which because of adjacent zoning including but not limited to any combination of retail shops, galleries, bars, restaurants, entertainment venues and related businesses, located in any public area including the streets, sidewalks and right-of-ways located within the City of Kenosha where the possession and consumption of Fermented Malt Beverages and/or Wine from an open container is permitted subject to an approved application, the regulations contained within this Ordinance and Chapter 125 of the Wisconsin State Statutes.
6. **Open Container** shall mean a paper or plastic cup which does not exceed 16 fluid ounces in size bearing a commercially printed name and/or logo of a Licensed Premises located within the Outdoor Open Container Entertainment Event boundaries.
7. **Wine** shall mean products obtained from the normal alcohol fermentation of the juice or must of sound, ripe grapes, other fruits or other agricultural products, imitation wine, compounds sold as wine, vermouth, cider, perry, mead and sake, if such products contain not less than 0.5 percent nor more than 21 percent of alcohol by volume.

B. Outdoor Open Container Entertainment Event. During dates, times and locations within areas of the city designated as Outdoor Open Container Entertainment Event, the possession and consumption of Fermented Malt Beverages and/or Wine purchased from a Licensed Premises in an Open Container are permitted, notwithstanding **Section 11.026** of the General Code of Ordinances.

C. Application.

1. Application for the Outdoor Open Container Entertainment Event shall be filed no later than thirty (30) days prior to the event date. The application shall be made to the City Clerk/Treasurer on form(s) furnished by the City Clerk/Treasurer and signed and sworn by the applicant. The application shall include:

- a. The name(s), business address(es) and telephone number(s) of the applicant(s).
- b. The aldermanic district in which the event location is located.
- c. The date(s) and period(s) of time for which the particular event will be operated.
- d. A detailed description of the location of the Outdoor Open Container Entertainment Event,

CODE OF GENERAL ORDINANCES, 2021 - KENOSHA, WISCONSIN

including a proposed map detailing the location.

- e. A detailed event security plan.
- f. A specific plan indicating where patrons will be permitted to carry the Fermented Malt Beverages and or Wine.
- g. **Street Closure.** Identify any proposed street closure, including proposed time and locations.
- h. **Public Entertainment.** A detailed description of all public entertainment associated with the Event.
- i. Certificate of Liability Insurance evidencing insurance in force and effect in the minimum amount of One Million Dollars (\$1,000,000.00), each occurrence, Two Million Dollars (\$2,000,000.00), general aggregate providing coverage for claims involving death, personal injury and property damage. The City shall be named as an additional insured with respect to the above insurance coverages and the City shall be provided with an additional insurance endorsement satisfactory to the City certifying that the City is an additional insured with respect to the insurance coverages above.
- j. Indemnity and Hold Harmless Agreement indicating the applicant(s) in consideration of having received a special event temporary extension, agrees to indemnify, defend and hold harmless the City of Kenosha, Wisconsin, and its officers, employees and agents against any and all losses, claims, damages, costs, expenses, judgments, awards, attorney fees, or settlements which they may incur as a result of the use of the city property for the Outdoor Open Container Entertainment Event.
- k. Such other reasonable and pertinent information as the Common Council or the Committee on Licenses/Permits may require.

2. Application Fee. The fee for an Outdoor Open Container Entertainment Event shall be paid to the City Clerk/Treasurer at the time of application submission. The application fee shall be \$150.00 for each Event.

D. Review and Approval. The City Clerk/Treasurer shall send the application to the Department of Public Works, Police Department and Fire Department for review and written comment. Following the review period, the Department of Public Works, Police Department and Fire Department shall send their comments to the City Clerk/Treasurer to be forwarded to the Committee on Licenses/Permits for a recommendation to Common Council. The Common Council shall grant or deny the application. The approval may be subject to reasonable terms and conditions.

E. Applicant's Responsibility.

1. Boundaries/Signs. Applicant shall be responsible for providing open and notorious notice of the Event boundaries to all participants throughout the Event by use of signs, barricades or other approved means.

2. Clean up. Applicant shall maintain the Event area in a clean, sanitary, neat and orderly appearance at all times during the Event. Applicant shall ensure that any Event refuse is removed from the Event area no later than twenty-four hours after the conclusion of the Event.

3. Security. Applicant shall provide security as detailed in the application security plan. All security personnel for an Event shall be clearly identified by approved uniform.

4. Other permits. Applicant shall secure any other permits required by the Code of General Ordinances for associated Event activities.

F. Operational Requirements. Outdoor Open Container Entertainment Events shall be subject to the following regulations.

1. Sale For Event Consumption. A Licensed Premises licensed to dispense Fermented Malt Beverages and/or Wine by the drink for consumption on the Licensed Premises is authorized to dispense Fermented Malt Beverages and/or Wine in an Open Container to a person of legal drinking age for removal from the Licensed Premises, provided however, that no Licensee shall dispense to any person more than one such Fermented Malt Beverage and/or Wine at a time for removal from the Licensed Premises, and no person shall remove at one time more than one such Fermented Malt Beverage and/or

CODE OF GENERAL ORDINANCES, 2021 - KENOSHA, WISCONSIN

Wine from the Licensed Premises.

2. Source of Fermented Malt Beverage and/or Wine. Open Containers of Fermented Malt Beverages and/or Wine within an Outdoor Open Container Entertainment Event must be purchased from a Licensee on the Licensed Premises within the Outdoor Open Container Entertainment Event boundaries. Alcohol in an Open Container within an Outdoor Open Container Entertainment Event which has not been purchased from an authorized Licensed Premises is prohibited.

3. Open Container. No container in which a Fermented Malt Beverage and/or Wine is dispensed and removed from the Licensed Premises shall exceed 16 fluid ounces in size. No container in which Wine is dispensed and removed from a Licensed Premises shall contain more than 6.5 fluid ounces of Wine. The container shall bear the commercially printed name and/or logo of the Licensed Premises from which it was dispensed.

4. Event Dates. Events shall be limited to the date(s) of the approved permits. An Event may last no more than three (3) days, which may or may not be consecutive, in any calendar year.

5. Hours of Operation. Open Containers of Fermented Malt Beverages and/or Wine shall not be permitted within an Outdoor Open Container Entertainment Event between the hours of 12:00 a.m. and 10:00 a.m. A Licensee shall not allow the removal of alcohol in an Open Container for the consumption of alcohol off a Licensed Premises between the hours of 12:00 a.m. and 10:00 a.m.

6. Possession or consumption of Open Containers of alcoholic beverages within or upon any parking lot, parking facility or motor vehicle within the Outdoor Open Container Entertainment Event shall be prohibited unless otherwise permitted by Wisconsin State Statute.

7. Possession or consumption of alcoholic beverages by an underage person within an Outdoor Open Container Entertainment Event is prohibited at all times except as otherwise permitted by law. All individuals wishing to possess or consume a Fermented Malt Beverage and/or Wine within an Outdoor Open Container Event must have a wristband with the commercially printed name or logo issued by the authorized Licensee which sold the Fermented Malt Beverage and/or Wine to the individual.

8. This Ordinance shall not be construed to prohibit the sale of alcoholic beverages in the original, unopened containers for off-premise consumption. However, consumption of alcoholic beverages sold in original, unopened containers for off-premise consumption shall not be permitted during the Outdoor Open Container Entertainment Event.

9. Consumption of alcohol within an Outdoor Open Container Entertainment Event from a can, bottle or a container which is not authorized pursuant to this Ordinance is prohibited.

10. Licensees shall not permit patrons to enter Licensed Premises with Fermented Malt Beverages and/or Wine acquired at another Licensed Premise or outside the Outdoor Open Container Entertainment Event boundaries.

11. Any Licensee permitting patrons to remove a Fermented Malt Beverage and/or Wine from the Licensed Premises for consumption during the Outdoor Open Container Entertainment Event shall employ a person to monitor all exits of the Licensed Premises to ensure that all beverages are removed in accordance with this Ordinance.

12. Neither Licensees nor patrons shall refill an Open Container with alcoholic beverages not purchased from the Licensed Premises from which the Open Container originated.

13. No person shall exit a designated Outdoor Open Container Entertainment Event boundary with Fermented Malt Beverages and/or Wine purchased in an Open Container for consumption within the

CODE OF GENERAL ORDINANCES, 2021 - KENOSHA, WISCONSIN

Outdoor Open Container Entertainment Event boundary.

14. Special events and areas temporarily licensed pursuant to Wisconsin Statutes Chapter 125, occurring within an Outdoor Open Container Entertainment District shall be subject to the provisions of this Ordinance.

15. Event specific operational requirements upon which approval of the application was conditional when approved by Common Council.

16. A Commercial Retail establishment which is not licensed to permit consumption of alcoholic beverages on premises shall not permit patrons to enter the establishment with an open container containing an alcoholic beverage at any time.

G. Penalty. Any person, party, firm, corporation or licensee who violates any provision of this Ordinance shall, upon conviction, forfeit not less than Two Hundred Dollars (\$200.00) and not more than Five Hundred Dollars (\$500.00), plus the cost of prosecution, in addition to all applicable surcharges and assessments. A person may be incarcerated in the County Jail for not more than ninety (90) days for the nonpayment of their forfeiture.

10.075 OUTDOOR EXTENSION OF A "CLASS B", CLASS "B" AND/OR "CLASS C" LICENSED PREMISES

A. Permission Required. No holder of a "Class B", Class "B" and/or "Class C" License may operate under said license(s) in any outdoor area, whether or not said outdoor area was included in a description of the licensed premises prior to the effective date of this Ordinance, without first having obtained the permission of the Common Council therefor in accordance with the terms and conditions of this Ordinance. Any "Class B", Class "B" and/or "Class C" License Holder whose license contained an outdoor area within the description of the licensed premises on the effective date of this Ordinance shall have ninety (90) days after the effective date of this Ordinance in which to obtain permission hereunder as a prerequisite to the continued utilization of said outdoor area. However, should such permission be applied for and denied during said ninety (90) day period of time, the utilization of said outdoor area as part of the licensed premises shall, upon denial, cease forthwith. The granting of permission hereunder shall result in the outdoor area becoming a part of the description of the licensed premises, with said outdoor area also being subject to all State and City laws, rules, regulations, and lawful orders governing "Class B", Class "B" and/or "Class C" licensed premises.

B. Application. Application for an outdoor extension of a "Class B", Class "B" and/or "Class C" License shall be made to the City Clerk on forms furnished by the City Clerk. The application shall include a map describing the outdoor area sought to be included within the description of the licensed premises. In the event that such map is omitted and the "Class B", Class "B" and/or "Class C" License is granted and issued, said license shall not be deemed to include an outdoor area within the description of the licensed premises.

C. Definition Of "Outdoor Area" As Used Herein. "Outdoor Area" shall mean an area, whether or not enclosed by a roof, which is open to the elements, and which is not constructed for year round use.

D. Requirements.

1. The outdoor area sought to be included within the description of the Retail Class "B", "Class B" and/or "Class C" licensed premises shall not:

- a.** Lie within a single family residentially zoned area of the City;
- b.** Have boundaries within twenty-five (25') feet of any single family dwelling, unless the single

CODE OF GENERAL ORDINANCES, 2021 - KENOSHA, WISCONSIN

family dwelling is zoned B-1 Neighborhood Business District, B-2 Community Business District, B-3 Central Business District or B-4 Mixed-Use District, or unless the only single family dwelling within twenty-five (25') feet of said boundary is occupied by the applicant and/or his or her immediate family and no others. Said boundary shall be measured from the nearest edge of the outdoor area boundary line to the nearest edge of the building foundation of the habitable area of the single family dwelling. The building foundation area shall not include porches, decks, gazebos or other accessory-like structures.

2. Any or all of the prohibitions set forth in §10.075 D.1. and D.3. of the Code of General Ordinances may be waived by the Common Council if the area sought to be included within the description of the Class "B", "Class B" and/or "Class C" licensed premises is located wholly within an area in the City zoned institutional, if the applicant is operating as a restaurant as defined by Section 5.046 A.9. of the Code of General Ordinances, or if it is an Outdoor Dining Area authorized and subject to a permit under Section 5.046 of the Code of General Ordinances. Any applicant for a waiver pursuant to this paragraph must file with his or her application a list of names and addresses of all property owners residing within twenty-five (25') feet of the boundaries of the outdoor area sought to be included within the description of the Class "B", "Class B" or "Class C" licensed premises. The application, along with the list of names, shall be filed with the Office of the City Clerk/Treasurer no later than fourteen (14) days before final action of the Common Council. Upon receipt of the Outdoor Extension Application and list of property owners within prescribed twenty-five (25') foot radius of subject licensed premises, the City Clerk/Treasurer shall forward said information to the Director of City Inspections for verification. Upon verification, the Director of City Inspections shall return said information to the City Clerk/Treasurer who will notify all property owners named on subject list. Said notice shall inform the addressee of dates, times and locations of the License/Permit Committee meeting and Common Council meeting where the matter of the application shall be discussed.

3. There shall be a fence surrounding the outdoor area sought to be within the description of the Class "B", "Class B" and/or "Class C" licensed premises. The fence shall not be less than forty-eight (48") inches high and not more than six (6') feet high. Any fence installed more than forty-eight (48) inches high shall be non-obscuring to permit a view of the outdoor area from the exterior. The Common Council, upon request, may waive that requirement where the licensed premises is operated as a restaurant within the meaning of Section 5.046 A.10 of the Code of General Ordinances.

4. The Director of Department of City Development, Department of City Inspections, or his or her designee shall investigate each application under this Section for compliance of this Section.

E. Restrictions Governing the Use of the Outdoor Area Included within the Description of a "Class B", Class "B" and/or "Class C" Licensed Premises.

1. Cabaret Licenses shall be extended to the licensed Outdoor Area subject to the following operational hours:

- a. 10:00 A.M. to 10:00 P.M. where the Outdoor Area has a boundary within seven hundred and fifty feet (750') of any residentially zoned property.
- b. 10:00 A.M. to 1:00 A.M. where the Outdoor Area's boundaries are greater than seven hundred fifty feet (750') of any residentially zoned property.
- c. Cabaret Licenses shall not be extended to an Outdoor Dining Area as defined by Section 5.046 of the Code of General Ordinances.

2. Amplified music or sound may be permitted in the licensed Outdoor Area only subject to strict compliance with Chapter XXIII of the Code of General Ordinances entitled "Noise Control" and the following operational hours:

- a. 10:00 A.M. to 10:00 P.M. where the Outdoor Area has a boundary within seven hundred fifty feet (750') of any residentially zoned property.
- b. 10:00 A.M. to 1:00 A.M. where the Outdoor Area's boundaries are greater than seven hundred

CODE OF GENERAL ORDINANCES, 2021 - KENOSHA, WISCONSIN

fifty feet (750') of any residentially zoned property.

c. Amplified music and sound shall be permitted in an Outdoor Dining Area as defined by Section 5.046 of the Code of General Ordinances and an Outdoor Cafe Area as defined by Section 10.076 of the Code of General Ordinances, subject to the distance limitations described in Subsections a. and b.

3. Any lighting of the outdoor area must be shielded so as not to shine directly onto adjoining property or create glare which is distracting to adjoining property owners or occupants.

4. There shall be strict compliance with Chapter XXIII of the Code of General Ordinances, Noise Control. The "Class B", Class "B" and/or "Class C" licensee shall be responsible for any violation of Chapter XXIII, whether or not present upon the premises at the time of violation.

5. The "Class B", Class "B" and/or "Class C" Licensee shall be responsible for cleaning litter from abutting properties which was deposited by patrons.

6. Any separate bar operating within the outdoor area shall be operated in conformity with Chapter 125, Wisconsin Statutes, and Chapter X of the City of Kenosha Code of General Ordinances.

7. The accumulation of more than fifty (50) demerit tracking points pursuant to Section 10.063 shall be a basis for denial, revocation or suspension of the Outdoor Area.

8. Chapter XXIII of the Code of General Ordinances, "NOISE CONTROL", shall be strictly complied with.

F. Closing Hours. Any outdoor area included within the description of a Class "B", "Class B" and/or "Class C" licensed premises pursuant to this Section shall be closed for business during the hours of 10:00 P.M. to 8:00 A.M.

The Common Council may, upon written application by the Licensee, limit the closing hours to 12:00 Midnight to 8:00 A.M.

If the licensed premises in the previous licensing term had its outdoor hours extended pursuant to the preceding paragraph, the Common Council may, upon written application by the Licensee, limit the closing hours to 1:30 A.M. to 8:00 A.M.

If the closing hours are so limited, amplified music or sound otherwise permitted under Section 10.075 E.2. shall not be allowed after 10:00 P.M.

G. Fees.

1. **One Time Processing Fee.** At the time of initial application for permission hereunder, applicant shall pay to the City Clerk a one (1) time Processing Fee of One Hundred Fifty (\$150.00) Dollars.

H. Scope of Use. The Common Council, upon notice and hearing and following review and recommendation by the Committee on Licenses/Permits, may limit the scope of the use of the outdoor area included or sought to be included within the description of the "Class B", Class "B" and/or "Class C" licensed premises, either in the process of the original approval or after the initial approval of the application for an extension of a "Class B", Class "B" and/or "Class C" License to an outdoor area. The limitation imposed may provide for a limitation on the activities permissible within the outdoor area during part or all of the time which the outdoor area is permitted to be or remain open. After the initial granting of permission for an outdoor area being included within the description of "Class B", Class "B" and/or "Class C" licensed premises under this Ordinance, the Common Council, in order to protect the rights of abutting owners and occupiers of land, may limit the Closing Hours of outdoor areas to any hour between 8:00 P.M. and 10:00 P.M.

CODE OF GENERAL ORDINANCES, 2021 - KENOSHA, WISCONSIN

I. Temporary Permits. The Common Council may temporarily extend a "Class B", Class "B" and/or "Class C" License to an outdoor area for up to six (6) events, an event lasting no more than three (3) consecutive days, in any calendar year and waive the requirement of Subsection D.3. of this Ordinance. There shall be a Fifty (\$50.00) Dollar processing fee for each such application.

J. Restriction Waiver. Upon written application to the City Clerk/Treasurer, the restrictions of Subsections E.1. and/or E.2. shall be waived if the application is filed seventy-two (72) hours prior to the date for which the waiver is sought, not including weekends and holidays, commencing at 8:00 A.M. of the day following the date at which a properly completed application was filed with the City Clerk/Treasurer; if the application is co-sponsored by the Alderperson of the district in which the license is located, or in the event that the Alderperson of the district is unavailable, co-sponsored by a member of the Committee on Licenses/Permits; and, if the Licensee/Applicant has not been issued a municipal citation for a violation of Chapter 10 of the Code of General Ordinances and/or Wisconsin Statutes Section 125 within the three hundred sixty-five (365) days preceding the application date. Should the applicant not meet the preceding qualifications, the application shall be referred to the Committee on Licenses/Permits for review. Said Committee shall recommend to the Common Council either the granting or denial of the application. Upon review, the Common Council may grant or deny the waiver application. Each application shall be made on forms furnished by the City Clerk/Treasurer and requires payment of a nonrefundable processing fee of Fifty (\$50.00) Dollars per application at the time the application is filed with the City Clerk/Treasurer.

K. Violations. Violations of this Ordinance shall subject the Licensee to any combination of the following:

1. A penalty pursuant to Section 10.08.
2. A limitation in the scope of use or time pursuant to Section 10.07 H.
3. Imposition of demerit tracking points pursuant to Section 10.063.
4. Upon notice and after hearing before the Committee on Licenses/Permits, the Common Council may revoke the outdoor extension granted herein.

10.076 OUTDOOR CAFÉ OF A "CLASS B", CLASS "B" AND/OR "CLASS C" LICENSED PREMISES IN A PUBLIC RIGHT-OF-WAY

A. Definitions. The following terms and phrases, for purposes of this Ordinance, shall have the meanings provided.

1. **"Alcohol Beverages"** shall mean intoxicating, liquor, wine and/or fermented malt beverages.
2. **"Applicant"** shall mean a licensed operation owner who is applying for a new or renewal permit to operate an Outdoor Cafe Area in a public right-of-way.
3. **"Cafe Appurtenance(s)"** shall mean tables, chairs, planters, barriers, railings, walls, signs, benches, waste receptacles, umbrellas and heaters.
4. **"Licensed business"** shall mean a business which holds a "Class B", Class "B", "Class C" License and/or a business which holds a Brewers permit issued by the Department of Revenue, State of Wisconsin pursuant to Wis. Stats. §125.29.
5. **"Outdoor Cafe Area"** shall mean a designated area where cafe appurtenance(s) are located on a sidewalk within a public right-of-way and operated as an integral part of an adjacent licensed business for the purpose of outdoor consumption of alcohol beverages.
6. **"Pedestrian Path"** shall mean a continuous, obstruction-free sidewalk area, between the outside boundary of the Outdoor Cafe Area and any obstruction. Obstructions include, but are not limited to, street trees, landscaping, street lights, benches, fire hydrants, utility boxes, utility poles, bus stops, public art and waste receptacles.
7. **"Permanent Improvements"** shall mean privately owned improvements and/or personal property attached to the ground by cement footings, bolts or similar attachment device.
8. **"Tavern"** shall mean any building or room where, as the establishment's primary business, Alcohol Beverages are served or sold to transients or the general public, and where the sale of Alcohol Beverages

CODE OF GENERAL ORDINANCES, 2021 - KENOSHA, WISCONSIN

account for more than fifty (50%) percent of the establishment's gross receipts in the B-1, B-2, B-3 or B-4 Zoning Districts.

B. Permission Required. No holder of a "Class B", Class "B", "Class C" License or holder of a Brewers permit issued by the Department of Revenue, State of Wisconsin pursuant to Wis. Stats. § 125.29 may operate under said license(s) in any outdoor area located within a public right-of-way without first having obtained the permission of the Common Council in accordance with the terms and conditions of this Ordinance. Any expansion or change in ownership of the business adjacent to the Outdoor Cafe Area shall require a new application, fee, review and approval.

C. Application. Application for an Outdoor Cafe Area located within a public right-of-way for Cafe of a "Class B", Class "B", "Class C" License and/or a business which holds a Brewers permit issued by the Department of Revenue, State of Wisconsin pursuant to Wis. Stats. §125.29 shall be made to the City Clerk on forms furnished by the City Clerk.

1. The application form shall include:

- a. Name, address and phone number of Applicant(s).
- b. Name, address and phone number of adjacent business.
- c. Whether the Outdoor Dining Area is the subject of Permanent Improvements.
- d. Nature of business.
- e. Maximum number of tables and chairs.
- f. Zoning District.
- g. Indemnity and Hold Harmless Agreement indicating the Applicant(s), in consideration of having received an Outdoor Cafe Area Permit, agrees to indemnify and hold harmless the City of Kenosha, Wisconsin, and its officers, employees and agents against any and all losses, claims, damages, costs, expenses, judgments, awards, attorney fees, or settlements which they may incur as a result of the use of the public right-of-way for an Outdoor Cafe Area.
- h. If the applicant holds a Brewers permit issued by the Department of Revenue, State of Wisconsin, a valid copy of the permit must be maintained on file with the City Clerk at all times.

2. Additionally, the following items shall also be required to be submitted with the application:

- a. An Operational Plan, including: hours, days and months of operation; planned capacity of Outdoor Cafe Area; and, a lighting and signage plan.
- b. A scaled Site Plan indicating: the location and boundary of the proposed Outdoor Cafe Area; the dimension of the remaining width of the sidewalk outside the Outdoor Cafe Area; the dimension from the Outdoor Cafe Area to the curb or property line and all buildings; and, the location of awnings, and Cafe Appurtenances within the Outdoor Cafe Area. The plans shall also indicate: existing property lines; associated building(s) and entrance(s); adjacent building(s) and entrance(s); extent of sidewalk adjacent to business(es), face of curb, location of fire hydrants, bus shelters and/or stops, trees, planters, utility poles, signs, benches, light poles, waste receptacles, driveways, alleys, vaults and any other obstructions within the public right-of-way at proposed location of Outdoor Cafe Area and for an additional twenty (20') feet extending therefrom.
- c. Photograph(s), a minimum of four (4") by six (6") inches, showing the entire sidewalk, with building facade proposed for the Outdoor Cafe Area.
- d. Certificate of Liability Insurance, with Contractual Liability Endorsement, showing insurance in force and effect in the minimum amount of One Million (\$1,000,000.00) Dollar single limits, providing coverage for claims involving death, personal injury and property damage. The City of Kenosha shall be a named additional insured under the terms of this policy.
- e. Where an Outdoor Cafe Area extends beyond the frontage of the Applicant's business, a written statement signed by the owner(s) and tenant(s) of an adjacent business fronting the street approving the placement of the Outdoor Cafe Area in front of their business.
- f. Where permanent improvements are proposed, their specifications shall be attached.
- g. A detailed description of all cafe appurtenance(s) to be located within the Outdoor Cafe Area, identifying the materials with which they are constructed together with photographs. They shall be of such

CODE OF GENERAL ORDINANCES, 2021 - KENOSHA, WISCONSIN

construction and quality such that they are consistent with the business/neighborhood district.

h. If the applicant holds a Brewers permit issued by the Department of Revenue, State of Wisconsin, a valid copy of the permit must be maintained on file with the City Clerk at all times.

D. Review and Approval. The City Clerk/Treasurer shall send the application to the Department of City Development, who shall forward a copy of the application to appropriate departments for review and written comment. Following the review period, the Department of City Development shall send a copy of the application and comments from City departments to the City Clerk/Treasurer to be forwarded to the Committee on Licenses/Permits for a recommendation to the Common Council. The Common Council shall grant or deny the application. The permit may be subject to reasonable terms and conditions.

Upon initial application and renewal of an Outdoor Cafe Area Permit, an Applicant shall not have their application approved when the Applicant's business has accumulated fifty (50) or more demerit points under Section 10.063 D. of the Code of General Ordinances.

E. Fee. The fee for an Outdoor Cafe Area Permit shall be paid to the City Clerk/Treasurer at the time of application submission. There shall be an initial review fee for an Outdoor Cafe of a "Class B", Class "B" or "Class C" License of One Hundred Fifty (\$150.00) Dollars. The initial review fee shall not be prorated. In addition, there shall be an annual renewal permit fee of One Hundred Fifty (\$150.00) Dollars for the permit term. Requests for renewals shall be made before the expiration of the existing permit. Expired Outdoor Cafe Area Permits are not subject to renewal.

F. Term. The permit term shall be from July 1 through June 30.

G. Transfer/Assignment. Permits shall not be transferable or assignable.

H. Renewal Application. The Applicant shall, on an annual basis, file a City authorized renewal application with the City Clerk/Treasurer prior to the term expiration. The following items shall be filed with the renewal form:

1. The annual renewal fee.
2. A valid Certificate of Liability Insurance.
3. Where an Outdoor Cafe Area extends beyond the frontage of the Applicant's business, an updated written statement signed by the owner(s) and tenant(s) of an adjacent business fronting the street approving the continued placement of the Outdoor Cafe Area in front of their business.

Permits recommended for renewal shall be renewed by the City Clerk/Treasurer, upon satisfactory submittal of all required items.

I. Renewal, Nonrenewal, Revocation or Suspension. The City Clerk/Treasurer shall verify the number of demerit points the Applicant's business has accumulated under Section 10.063 D. of the Code of General Ordinances at the time of renewal. Businesses that have accumulated fifty (50) or more demerit points at the time of renewal shall be subject to suspension or revocation of an Outdoor Cafe Area Permit. Recommendation for nonrenewal, revocation or suspension shall be forwarded to the Committee on Licenses/Permits for action, at any time, following a hearing. The determination of the Committee may be appealed to the Common Council by filing a notice of appeal with the City Clerk/Treasurer within ten (10) days of the date of the hearing determination.

J. Conditions of Issuance of Permit.

1. Design Regulations.

a. A clear, continuous Pedestrian Path, parallel to the curb or adjacent property line, and not less than four (4') feet in width, shall be required for pedestrian circulation outside of the Outdoor Cafe Area, except where a reduction is permitted under Section M. In areas of heavy pedestrian traffic, a width greater than four

CODE OF GENERAL ORDINANCES, 2021 - KENOSHA, WISCONSIN

(4') feet may be required.

b. All Cafe Appurtenances located in an Outdoor Cafe Area shall not be permanently attached to any sidewalk, curb, building, tree, post, public bench, waste receptacle or any other fixture within the public right-of-way. Cafe Appurtenances may be permanently attached when approved as a Permanent Improvement in the Outdoor Cafe Area.

c. Fixed or retractable awnings in compliance with Section 15.06 F. of the Zoning Ordinance are permitted over Outdoor Cafe Areas.

d. All cafe appurtenances located in an Outdoor Cafe Area must be approved by the Committee on Licenses/Permits prior to use.

2. Location Regulations.

a. Locations of Outdoor Cafe Areas shall be limited to areas where the sidewalk pavement width within the public right-of-way is at least ten (10') feet from the face of the curb to the building or property line, except where a reduction is permitted under Section M. A sidewalk partially located upon private property adjacent to the public right-of-way, may be counted toward the minimum ten (10') foot sidewalk width provided the required Pedestrian Path shall be entirely located within the public right-of-way.

b. An Outdoor Cafe Area may be located directly adjacent to and abutting the associated licensed business, and/or located where it abuts the curb and is at least two (2') feet from the face of the curb. Outdoor Cafe Areas located adjacent to an approved loading zone shall not be required to be located two (2') feet from the face of the curb. In no case shall the Pedestrian Path be reduced to less than a minimum width of four (4') feet, except where a reduction is permitted under Subsection M.

c. The Outdoor Cafe Area may not include within its boundaries bus stops, fire hydrants or other facilities deemed necessary for public safety.

d. An Outdoor Cafe Area shall be located at least five (5') feet from fire hydrants, driveways, alleys, bus shelters and/or stops. In no case shall Cafe Appurtenances greater than three (3') feet in height be located within the fifteen (15') foot vision clearance triangle required under Section 2.06 of the Zoning Ordinance for the City of Kenosha, Wisconsin.

3. Operational Regulations.

a. An Outdoor Cafe Area shall be an accessory use located adjacent to a licensed business and may extend in front of an adjacent business as permitted under Section C.2.a.

b. All Cafe Appurtenances shall be movable, unless approved as a Permanent Improvement, and arranged to adequately accommodate persons with disabilities. Cafe Appurtenances shall not impede building ingress and egress or encroach into the Pedestrian Path at any time. A clear area shall be maintained from all building entrances located adjacent to an Outdoor Cafe Area to the Pedestrian Path. The clear area shall have a minimum width of three (3') feet or a width equal to the width of the entrance, whichever is greater. Cafe Appurtenances shall be permitted to remain within the Outdoor Cafe Area at the close of business each day, unless determined to be a public safety hazard.

c. Umbrellas shall have a vertical clearance of at least seven (7') feet, and be adequately secured and anchored with a heavy ballast holder to prevent displacement by the wind.

d. Amplified music or sound may be permitted in the Outdoor Cafe Area only subject to strict compliance with Chapter XXIII of the Code of General Ordinances entitled "Noise Control" and the following operational hours:

1. 10:00 A.M. to 10:00 P.M. where the Outdoor Cafe Area has a boundary within seven hundred fifty feet (750') of any residentially zoned property.

2. 10:00 A.M. to 1:00 A.M. where the Outdoor Cafe Area's boundaries are greater than seven hundred fifty feet (750') of any residentially zoned property.

e. Cabaret Licensed activities are prohibited.

f. Outdoor Cafe Areas shall provide adequate lighting in and around the designated area(s) at all times. Lighting fixtures shall be limited to fixtures attached to the building facade or upon private property. Battery operated lamps or candles placed on tables are permitted. Lighting shall not be a public or private nuisance.

g. Portable propane heaters are permitted within the Outdoor Cafe Area provided they are a minimum

CODE OF GENERAL ORDINANCES, 2021 - KENOSHA, WISCONSIN

of eighty (80') inches in height and located at least five (5') feet from a building.

h. Electrical and propane infrared heaters, or similar heating devices approved for outdoor use, are permitted to be attached to building facades and shall be installed according to the manufacturer's specifications and appropriate Building, Electrical and Mechanical Codes.

i. All food and drink preparation shall be performed in the affiliated business. No food or drink preparation or storage shall be permitted within the Outdoor Cafe Area.

j. Any Outdoor Cafe Area permitted pursuant to this Section shall be closed for business during the hours of 10:00 P.M. To 8:00 A.M. If the property on which a licensed premises is situated is zoned B-2, B-3 or B-4 and does not abut a property zoned RR-1, RR-2, RS-1, RS-2, RS-3, RD, RG-1, RG-2, RM-1, RM-2, or IP, the Common Council may, upon written application by the Licensee, limit the closing hours to 12:00 Midnight to 8:00 A.M. If the property on which a licensed premises is situated is zoned B-2, B-3 or B-4 and does not abut a property zoned RR-1, RR-2, RS-1, RS-2, RS-3, RD, AG-1, RG-2, RM-1, RM-2, or IP, and the Licensee in the previous licensing term had its outdoor hours extended pursuant to the preceding paragraph, the Common Council may, upon written application by the Licensee, limit the closing hours to 1:30 A.M. To 8:00 A.M.

k. Outdoor Consumption in Outdoor Cafe Areas shall be limited to the designated area(s) identified on the approved application.

l. The sidewalk area within and immediately surrounding the designated Outdoor Cafe Area shall be maintained in a clean, sanitary, neat and orderly appearance at all times. Litter shall be removed by the permit holder on a periodic basis during the day and at the close of business each day.

m. Outdoor Cafe Areas and Cafe Appurtenances shall be permitted to occupy sidewalks within the public right-of-way throughout the year; provided, however, snow and ice removal shall be the obligation and at the expense of the permit holder.

n. The approval of an Outdoor Cafe Area shall not be construed or deemed to create a vested interest in the public right-of-way. The permit holder shall remove or modify an Outdoor Cafe Area at their own expense whenever the City determines it necessary or desirable to modify the width of the street and/or public sidewalk.

o. Outdoor Cafe Areas shall be equipped with receptacles for cigarette waste. Cigarette waste shall be removed by the permit holder on a periodic basis during the day and at the close of business each day.

p. Server shall be within sight and sound of licensed operator.

K. Violations. Violations of this Ordinance shall subject the Licensee to any combination of the following:

1. A penalty pursuant to Section 10.076 O.
2. Written orders related to the scope and use of the Outdoor Cafe Area. Unless otherwise stated, orders are permanent, unless rescinded.
3. Imposition of demerit tracking points pursuant to Section 10.063.
4. Upon notice and after hearing before the Committee on Licenses/Permits, the Common Council may revoke the outdoor Cafe granted herein pursuant to Section 10.063 I. However, all Outdoor Appurtenances may be removed without prior notice or opportunity to be heard where it constitutes an immediate danger to the public health, safety or welfare, where it is not in conformance with representations made in the application, where the Certificate of Insurance was not provided or has expired, or where placed within any public right-of-way without a permit, contrary to the provisions of this Ordinance. In such cases, an opportunity for a post-removal hearing shall be provided following the foregoing provisions for an appeal.

L. Relocation by the City. Notwithstanding the foregoing regulations, the City, at its discretion, may relocate an approved Outdoor Cafe Area on a temporary basis to an adjacent sidewalk within a public right-of-way, partially within the public right-of-way and partially upon private property within the Major Street Setback Area, and/or upon public property, including the publicly held rights-of-way to accommodate a public works project and mitigate the interruption of the permit operation. Application for relocation shall be made in writing to the Department of Public Works at least thirty (30) days prior to the proposed date of relocation and include a written statement signed by a majority of all of the owner(s) and the tenant(s) of adjacent occupied property(ies) approving the temporary relocation. The Department of Public Works shall submit the

CODE OF GENERAL ORDINANCES, 2021 - KENOSHA, WISCONSIN

application to the Department of City Development, Fire Department, Police Department and the alderperson of the District in which the Applicant's business is located for review and recommendation, which must be returned to the Department of Public Works within seven (7) days of receipt. In such a case, the City, at the direction of the Director of Public Works, will determine the duration, the temporary location and provide the Permittee a site plan describing the temporary Outdoor Cafe Area.

M. Enforcement. The enforcement of this Ordinance shall be under the jurisdiction of the Department of City Development and Kenosha Police Department, who shall have the power to inspect Outdoor Cafe Areas to determine compliance with this Ordinance. The Department of City Development shall be primarily responsible for enforcement during regular City Hall working hours. The Kenosha Police Department shall be primarily responsible for enforcement of this Ordinance during all other hours. Violations that are enforced by the Police Department shall be communicated to the Department of City Development.

Compliance with this Ordinance shall be obtained through written orders to the applicant, issued by the Department of City Development. Except in emergency situations, a minimum of ten (10) days shall be provided for compliance. Orders which are not timely complied with shall be subject to a suspension or revocation of an Outdoor Cafe Area Permit and/or a financial penalty, as specified in this Ordinance.

N. Special Exceptions. With respect to the following items, the Department of City Development shall have the discretion to recommend approval of alternative standards to the Committee on Licenses/Permits. The exceptions shall not present any hazard or danger to the public safety, health or welfare, and shall also meet the standards listed under each item.

1. Pedestrian Paths. The Pedestrian Path, as referenced in Section J.1.a., may be reduced in width, provided the reduction meets the following standards:

- a. The Pedestrian Path shall not be reduced to less than three (3') feet in width.
- b. The location of the Outdoor Cafe Area is not located adjacent to a major street.
- c. Pedestrian traffic is minimal in the location of the proposed Outdoor Cafe Area.
- d. The Outdoor Cafe Area is enclosed by a barrier, as specified in Section J.1.e., to separate the cafe area from the required Pedestrian Path.

2. Sidewalk Width Requirement. The required sidewalk width, as referenced in Section J.2.a., maybe reduced to less than ten (10') feet, provided the reduction meets the following standards:

- a. The sidewalk shall not be reduced to less than eight (8') feet in width.
- b. The location of the Outdoor Cafe Area is not located adjacent to a major street.
- c. The strict application of the required sidewalk width would result in denial of the application.

3. Paving of Lawn Park Areas. Paving of the lawn park area may be permitted when it meets the following standards:

- a. The paving has been approved by the Committee on Public Works.
- b. The paved lawn park area is conditioned upon removal and restoration of the lawn park area to prior conditions upon discontinuance of the Outdoor Cafe Area.

O. Other Codes. Permits issued hereunder are conditioned upon compliance with the Building, Health, Fire and Zoning Codes, and inspections, licenses, approvals and permits thereunder, which may be applicable.

P. Penalty. Any person, party, firm or corporation who violates any provision of this Ordinance shall, upon conviction, forfeit not more than Five Hundred (\$500.00) Dollars, plus the cost of prosecution. Each day of violation shall be deemed a separate offense. A person may be incarcerated in the County Jail for not more than ninety (90) days for the nonpayment of their forfeiture.

10.077 UNOBSTRUCTED VIEW OF INTERIOR PREMISES

"Class B" and/or Class "B" License Holders shall, at all times, keep glass windows and doors clean and unobstructed so as to permit a view of the interior of the licensed premises from outside of the licensed premises. License Holders whose premises are without a glass window or door shall install one

CODE OF GENERAL ORDINANCES, 2021 - KENOSHA, WISCONSIN

(1) glass window of at least one (1) square foot in size prior to May 1, 1985.

10.078 COVID-19 TEMPORARY OUTDOOR EXTENSION

Findings and Purpose.

A. Findings.

1. A novel strain of the coronavirus, named COVID-19 spread throughout numerous countries including the United States during the late winter and spring of 2020 resulting in Federal, State and Local Declarations of Emergency and Emergency Orders that limited in person business transactions, closed some businesses, required changes to business operations and had for many businesses a dramatic economic impact.

2. That the Common Council by Resolution 49-20, declared a state of emergency in the City of Kenosha due to the existence of COVID-19 in the city pursuant to its authority under Wis. Stats. Sections 323.11 and 323.14.

3. There is a need to continue to prevent exposure to and spread of the COVID-19 coronavirus by increasing social distancing during the COVID-19 pandemic and recovery period.

4. That the Center for Disease Control and Prevention ("CDC") has published its Public Health Considerations for Reopening Restaurants and Bars During the COVID-19 Pandemic and has encouraged social distancing and enhanced spacing at food and beverage establishments including limiting party sizes and occupancy.

5. That the Kenosha Kickstart guideline published by the Kenosha County Health Department suggests limiting tables to 6 guests and utilizing outdoor seating to recover lost seating within an establishment due to physical distancing.

6. The restaurants, bars and taverns within the City of Kenosha may have particular difficulty providing recommended social distancing and operating profitably within the confines of their buildings and may wish to provide additional or alternative temporary seating outdoors.

7. It is in the best interest of the City of Kenosha and the City of Kenosha food and beverage industry to provide temporary relief to restaurants, bars and taverns by adjusting certain local code requirements related to such businesses during the COVID-19 pandemic and recovery period to allow those businesses to utilize parking areas, right of ways, sidewalks, open spaces and adjacent properties during this limited period to maximize their service area.

8. It is in the best interest of the City and the operating restaurants, bars and taverns to provide a temporary outdoor extension that may be issued by city staff upon the applicant meeting certain criteria and avoiding the delay of council and committee approvals for this temporary use.

B. Purpose. The City of Kenosha pursuant to the emergency powers authorized by sections 323.11 and 323.14 permit COVID-19 temporary outdoor extension to Class "B", "Class B", "Class C" licensed establishments or Permitted State Brewers which commit to practicing social distancing guidelines described within the application necessary to protect, preserve and promote the general health, safety and welfare of the public, slow the spread of COVID-19 and support the economic stability of licensed establishments.

C. Term. All COVID-19 temporary extensions issued pursuant to this section begin on May 1, 2021 and terminate on the earlier of November 1, 2021, or the date the licensee ceases to hold a Class "B", "Class B" and/or "Class C" license, whichever is earlier. Temporary extensions are not assignable or transferable. The temporary extension is effective only for the period during which the licensee has a valid temporary extension issued under this section and upon termination of the temporary extension, the licensed area reverts to the area identified and approved by the Common Council.

CODE OF GENERAL ORDINANCES, 2021 - KENOSHA, WISCONSIN

D. Application. Application for a COVID-19 temporary outdoor extension of a "Class B", Class "B", "Class C" License and/or a business which holds a Brewers permit issued by the Department of Revenue, State of Wisconsin pursuant to Wis. Stats. §125.29 must be made to the City Clerk on forms furnished by the City Clerk.

1. The application form must include:

- a. Name, address and phone number of applicant(s).
- b. Name, address and phone number of adjacent business(es).
- c. Type of alcohol license(s) held by business.
- d. Maximum number of tables and chairs proposed. Limit of 6 chairs per table. Spacing of 6 feet between proposed seating areas required.
- e. Statement of need due to COVID-19 social distance guidelines.

2. Additionally, the following items are required to be submitted with the application:

a. An Operational Plan, indicating the manner in which the applicant will be modifying its normal business operation to require social distancing recommended by the CDC, including: hours, days and months of operation; planned capacity of the temporary extension; and, a lighting and signage plan.

b. A scaled Site Plan indicating when applicable: the location and boundary of the proposed temporary extension; the dimension of the remaining width of the sidewalk outside the temporary extension; the dimension from the temporary extension to the curb or property line and all buildings; and, the location of awnings, and appurtenances within the temporary extension; existing property lines; associated building(s) and entrance(s); adjacent building(s) and entrance(s); extent of sidewalk adjacent to business(es), face of curb, location of fire hydrants, bus shelters and/or stops, trees, planters, utility poles, signs, benches, light poles, waste receptacles, driveways, alleys, vaults and any other obstructions within the public right-of-way at proposed location of temporary extension and for an additional twenty (20') feet extending therefrom.

c. Photograph(s), a minimum of four inches (4") by six (6") inches, showing the entire sidewalk, with building facade proposed for the temporary extension.

d. A detailed description of all appurtenance(s) to be located within the temporary extension, identifying the materials with which they are constructed together with photographs. Construction and quality consistent with the business/neighborhood district is preferred and the temporary use will be considered.

e. If the applicant holds a Brewers permit issued by the Department of Revenue, State of Wisconsin, a valid copy of the permit must be maintained on file with the City Clerk at all times.

f. When proposed temporary extension is **located in a public right-of-way, on a city street or on city property**, a Certificate of Liability Insurance, with Contractual Liability Endorsement, showing insurance in force and effect in the minimum amount of One Million (\$1,000,000.00) Dollar single limits, providing coverage for claims involving death, personal injury and property damage. The City of Kenosha must be a named additional insured under the terms of this policy. The policy shall also be primary and non-contributory.

g. When proposed temporary extension is **located in a public right-of-way, on a city street or on city property**, an Indemnity and Hold Harmless Agreement indicating the applicant(s), in consideration of having received a temporary extension, agrees to indemnify and hold harmless the City of Kenosha, Wisconsin, and its officers, employees and agents against any and all losses, claims, damages, costs, expenses, judgments, awards, attorney fees, or settlements which they may incur as a result of the use of the public right-of-way, city street or city property.

E. Operational Regulations. All operational regulations, design regulations and service limitations applicable to an outdoor dining permit, an outdoor cafe permit, identified in Sections 5.046/10.076 - Code of General Ordinances, are applicable to temporary extensions issued pursuant to this section located in a public right-of-way, on a city street or on city property. If located where a motor vehicle could otherwise lawfully be operated, but not for the approved temporary extension, the submitted operational plan should identify safety protocols, including whether a physical barrier will be installed to protect patrons from motor vehicles. All operational regulations, design regulations and service limitations applicable to an outdoor extension, identified in Section 10.075 – Code of General Ordinances, are applicable to temporary extensions issued pursuant to this section located on the licensee's property. Where permanent improvements may be otherwise required, temporary improvements may be approved during the temporary term of the extension granted.

F. Site Location Exception. Site locations, the area described in the application that will be the location of the temporary extension approved pursuant to this section, which would otherwise be prohibited upon application

CODE OF GENERAL ORDINANCES, 2021 - KENOSHA, WISCONSIN

made pursuant to a permanent outdoor extension application, an outdoor dining application or an outdoor cafe application, due to the location regulations, may be permitted upon the review and approval of the application due to the temporary nature of the extension and the emergent circumstances associated with COVID-19. Notwithstanding the foregoing, site locations must maintain contiguity with the license establishments.

G. Review and Approval. The City Clerk/Treasurer will send the application to city departments (Public Works, City Development, Fire, Police) for review and written comment must be returned within seven (7) days. Absent objections from any of the reviewing departments the temporary extension may be issued by the Clerk. The temporary extension may incorporate reasonable terms and conditions of the reviewing departments. An application will not be approved if the applicant's business has accumulated fifty (50) or more demerit points pursuant to Section 10.063 D. of the Code of General Ordinances.

H. Appeal. Should the Clerk deny the application for a COVID-19 temporary extension, the applicant, by filing a written Notice of Appeal with the City Clerk/Treasurer within five (5) business days following, but not including, the day of denial, may appeal said denial to the Common Council. The appeal will be heard at a scheduled Common Council meeting as soon as practicable. However, to be heard at a given Common Council meeting, the Notice of Appeal must be filed a minimum of two (2) City business days prior to said meeting, not including the day of the scheduled meeting.

I. Violations. Violations of this Ordinance subject the Licensee to any combination of the following:

1. A penalty pursuant to Section 10.08.
2. A limitation in the scope of use or time pursuant to Section 10.07 H.
3. Imposition of demerit tracking points pursuant to Section 10.063.
4. Upon notice and after hearing before the Committee on Licenses/Permits, the Common Council may revoke the temporary extension granted herein.

10.08 PENALTIES

A. Penalties for violating any provision in conformity with the Wisconsin Statutes shall be the same as provided for by said Statutes.

B. Persons violating any provision of this Chapter, authorized by Section 125.10, Wisconsin Statutes, shall not forfeit more than Five Hundred (\$500.00) Dollars per count, plus all applicable costs.

C. Each day a person is in violation may constitute a separate count.

D. A person may be incarcerated in the County Jail for not more than ninety (90) days for the nonpayment of their forfeiture.

CODE OF GENERAL ORDINANCES, 2021 - KENOSHA, WISCONSIN

APPENDIX 10.063 - DEMERIT POINT SCHEDULE

VIOLATION	STATUTE/ORDINANCE	1ST OFFENSE
Violation of an order of the Common Council	10.063, 10.064, 10.07, 10.076, 5.046	100
Non-Compliance with OWI Alcohol Assessment	343.301, 125.07(4)(d)(2)(a), 10.01	100
Conviction for a violation of State or Federal criminal law which is a felony, if the circumstances of the charge substantially relate to the circumstances of the licensed activity	Any Felony as defined by Wisconsin Statutes, including 940.09, 940.25	100
Social Host	11.025	100
OWI/BAC (Criminal)	346.63	80
OWI/BAC (Civil)	346.63	50
Synthetic Marijuana - Sale	961.41(1m)(hm), 11.147	50
Misrepresenting Age by False I.D.	125.07(4)(a)(4), 10.01	50
Failure to Appear Before Committee or Common Council	10.063, 10.064, 10.07, 10.076, 5.046	50
Non Felony - Duty Upon Striking Person or Attended or Occupied Vehicle - Hit/Run	346.67	50
Duty Upon Striking Unattended Vehicle, Duty Upon Striking Property on or Adjacent to Highway – Hit/Run	346.68 and 346.69	50
Failure to Stop for School Bus	346.48 (1)	50
Off Licensed Premises Conduct	10.064	25
Sale to Underage Person	125.07(1)(a), 10.01	25
Sale Without a License	125.32(2), 10.01, 125.68	25
Underage Procure	125.07(4)(a)(1), 10.01	25
Providing a False ID to Underage Drinker	125.085(3)(a)	25
Synthetic Marijuana - Possess	961.41(3g)(b), 11.147	25
Possession of Marijuana Misdemeanor	961.41(3g)(b), 11.146	25
Obstruction / Resisting	11.02 Q.	25
No Licensed Bartender on Premises	125.32(2), 10.01	20
Unauthorized Purchase of Alcohol - Records	125.69(6)(a), 10.01, 10.05, 139.11	20

CODE OF GENERAL ORDINANCES, 2021 - KENOSHA, WISCONSIN

VIOLATION	STATUTE/ORDINANCE	1ST OFFENSE
Unauthorized Purchase of Beer - Records	125.33(9), 10.01, 10.05, 139.11	20
Cabaret License Violations	10.07	20
Sale After Hours	125.32(3)(am), 10.01, 125.68	20
Sale to Intoxicated Person	125.07(2)(a)2., 10.01	20
Inspection and Search of Premises	10.05 B.	20
Unobstructed View of Interior Premises	10.077	20
Open After Hours	125.32(3)(a), 10.01, 125.68	20
Drive Through Regulations	10.05 J.	20
Outdoor Café	10.076	20
Outdoor Dining	5.046	20
Conviction for a violation of State criminal law which is a misdemeanor, if the circumstances of the charge substantially relate to the circumstances of the licensed activity.	Any misdemeanor as defined by Wisconsin Statutes	20
Underage Consumption/Possession	125.07(4)(b), 10.01	20
Open Intoxicants in Motor Vehicle Driver	346.935(1), 7.01	20
Cruelty to Animals	14.055	20
Permit Underage Person to Loiter on Premises	125.07(3)(b), 10.01	15
Employee Conduct	10.05	15
Underage in Premises	125.07 (4)(a)(3), 10.01	15
False Identification	125.085(3)(b)	15
Amplified Music	11.14 B.	10
Retail Theft	11.053	10
Gambling	11.04	10
Operational Requirements	10.05 G.	10
Pawnbroker/Secondhand License	13.02	10
Taxi License	13.07	10
Disorderly Conduct	11.02 M.	10
Battery	11.02 V.	10
Alcohol on Public Street	11.026	10

CODE OF GENERAL ORDINANCES, 2021 - KENOSHA, WISCONSIN

VIOLATION	STATUTE/ORDINANCE	1ST OFFENSE
Operating After Revocation	343.44(1)(b), 7.01	10
Operating After Suspension	343.44(1)(a), 7.01	10
No Valid Drivers License	343.05(3), 7.01	5
Open Intoxicants in Motor Vehicle Passenger	346.935(1), 7.01	5
License Not Posted /Proper Display	125.04(10), 10.01	5
Chapter 12 Amusement Enterprise/Device License	12.001, 12.01	5
Tobacco Violations (sale)	13.09	5
Smoking Prohibition (Bartender Only)	4.05	5
No Drivers License on Person	343.18(1), 7.01	0
Chapter 125 Violations Not Specified	Chapter 125	20 Demerit Points Unless Otherwise Assigned by Common Council
Ordinance Chapter 10 Violations Not Specified	Chapter 10	20 Demerit Points Unless Otherwise Assigned by Common Council
Ordinance Chapter 11 Violations Not Specified	Chapter 11	10 Demerit Points Unless Otherwise Assigned by Common Council
Ordinance Chapter 12 Violations Not Specified	Chapter 12	20 Demerit Points Unless Otherwise Assigned by Common Council
Ordinance Chapter 13 Violations Not Specified	Chapter 13	20 Demerit Points Unless Otherwise Assigned by Common Council
False Application	False Application	20 Demerit Points Unless Otherwise Assigned by Common Council

CODE OF GENERAL ORDINANCES, 2021 - KENOSHA, WISCONSIN

Violation of any other Federal, Out of State, State, County or Municipal offense which are substantially similar or in conformity to those violations listed herein, shall be assigned the same number of demerit points listed above unless otherwise assigned by Common Council.

The demerit points for a violation occurring on a second date within 365 consecutive days of a prior violation of the same statute/ordinance shall be assigned double the point assessment assigned herein.

CODE OF GENERAL ORDINANCES, 2021 - KENOSHA, WISCONSIN

CHAPTER XI OFFENSES AGAINST GOOD ORDER AND CONDUCT

11.02 DISORDERLY CONDUCT

No person shall within the limits of the City commit any of the following offenses, namely;

A. Firearms. Discharge or cause the discharge of any missile from any firearm, B.B. gun, pellet gun, paintball gun, slingshot, bow and arrow, when said bow has a pull of 30 pounds pressure or more, or, other dangerous weapon within the limits of the City, except at gun clubs, rifle ranges, archery ranges or shooting galleries. This Section does not apply to firearms used by law enforcement officers or to hunting by bow and arrow or by crossbow, pursuant to the regulation of Paragraph 11.02 T.2. of these Ordinances, or to the discharge of any of the aforesaid weapons within the limits of the City upon written permission from the Chief of Police which authorizes a specified person(s), for a specified purpose and period of time. Any such permission may be revoked by the Chief of Police at any time.

B. Fights. Engage in any fight, brawl, or noisy altercation on any street, alley, or other public ground.

C. Throwing Snowballs and other Objects.

1. Throw any snowball or other object at or in the direction of any moving or occupied motor vehicle, bicycle or other means of conveyance in a manner likely to cause or causing personal injury or property damage.

2. Throw any snowball or other object at or in the direction of any window or door of any building or structure in a manner likely to cause or causing personal injury or property damage.

3. Throw any snowball or other object in a manner likely to cause or causing personal injury or property damage, excluding games and sports which do not have personal injury or property damage as a goal.

The throwing of objects and snowballs is not prohibited if said objects and snowballs are of such small size and weights as not to create a danger to person or property.

"**Snowball**" is defined as a compacted mass of snow and/or ice, whether or not any foreign objects are embedded therein, which is of a size capable of being thrown.

4. Intentionally throw or drop any object of any kind or nature from any bridge, building or structure in a manner likely to cause or causing personal injury or property damage, excluding construction or demolition work done in accordance with an appropriate permit, and excluding any act involving the exercise of the police powers or duties of any unit of government.

5. Except for approved applicants which participate in the Kenosha Civic Veteran's Parade, no person shall throw or shoot any object, missile, spray or other solid, fluid or semi-fluid projectile by hand or any other means at any person or object along the route of a parade during the period from the beginning of the parade to the end of the parade. This Section shall only apply to parades held on highways and public streets.

D. Indecent Conduct. Conduct himself in a tumultuous, riotous, or indecent manner.

E. Objectionable Language. Use any profane, vile, filthy or obscene language in any public place within the hearing of other persons in such public place.

CODE OF GENERAL ORDINANCES, 2021 - KENOSHA, WISCONSIN

F. Assault. Assault another or use in reference to and in the presence of another, or in reference to and in the presence of any member of his family, abusive or obscene language, intended or naturally tending to provoke an assault or any breach of the peace.

G. Prowling About Premises of Another. Prowl about the premises of another in the night time, or peek in windows on another's premises, or do any other act intended, or naturally tending, to frighten or alarm other persons.

H. Incite Violence. Knowingly insult, provoke or disturb any person or persons by means of any gesture, language or obscene, lewd or lascivious act in a manner which does or is likely to provoke a violent response in the recipient thereof.

I.1. Obstruct or interfere with, by any means, vehicular or pedestrian traffic on any public walk, highway, street, alley or other public thoroughfare for the purpose of disrupting the orderly pattern and flow thereof.

2. Impede, intentionally or unintentionally, the flow of vehicular or pedestrian traffic on any public walk, highway, street, alley or other public thoroughfare, or in or about any governmental building or premises open to the general public, or in any parking lot or structure after having been requested to cease said activity by a peace officer or by one in charge of said premises.

J. Disturbance of Meeting. Disturb or annoy any congregation, audience, public meeting, or lawful assembly of persons of any kind, or join with others in so doing.

K. Maltreat or annoy any person in any public place.

L. Court Restraining Orders.

1. Violate the provisions of a Domestic Abuse Restraining Order issued under §813.12, Wisconsin Statutes.

2. Violate the provisions of any other Court Order restraining a person from harassing or contacting directly or indirectly any other person or place of business.

M. Disturbance of Peace. Engage in violent, abusive, indecent, profane, boisterous, unreasonably loud, or otherwise disorderly conduct under circumstances in which such conduct tends to cause or provoke a disturbance.

N. Mashing. Improperly accost, ogle, insult, follow, pursue, lay hands on, or otherwise molest any person of the opposite sex.

O. Begging. In any public place, or from place to place beg or receive alms without the written permission from the Mayor.

P. No person shall smoke, drink or consume food in any local passenger bus.

Q. Obstructing Firemen or Policemen/False Complaints of Police Misconduct.

1. It shall be unlawful for any person to willfully hinder, obstruct or otherwise interfere with the Fire or Police Department, or any member thereof, while engaged in fighting a fire or in traveling thereto or therefrom, or while otherwise engaged in the performance of his/her duty or any official function, or to willfully damage or destroy any property belonging to the Fire or Police Department, or any member thereof, while so engaged, or to commit an assault, battery, or throw any object upon a member of the Fire or Police Department while so engaged.

CODE OF GENERAL ORDINANCES, 2021 - KENOSHA, WISCONSIN

2. Any person who is reasonably suspected of having information relating to a crime, Ordinance violation, or any other matter under the jurisdiction of the Police Department, and who intentionally refuses to furnish identifying information to a law enforcement officer investigating said matter shall be deemed in violation of this Ordinance.

"**Identifying Information**" shall include: name, address, phone number, age and place of employment and/or school attended, if any. If the address provided is one that said person has not resided at for at least thirty (30) days, "**Identifying Information**" shall also include the name, address and phone number of a person, if any, who is reasonably likely to know the whereabouts of the person being questioned.

3. The provisions and definitions of Section 946.66 of the Wisconsin Statutes, and also all acts amendatory thereof and supplementary thereto, are adopted and incorporated herein. Whoever knowingly makes a false complaint regarding the conduct of a law enforcement officer shall, upon conviction, be subject to the penalties set forth in **Section 11.17** below.

R. Possession or Use of Fire Bombs and Other Similar Devices.

1. It shall be unlawful for any person to make carry, possess, sell, give, or use any type of "Molotov Cocktail" which is defined to mean a flammable liquid-filled bottle or container with a fuse, wick, or any other type of ignition or detonating device.

2. It shall be unlawful for any person to make, carry, possess, sell, give, or use any type of flammable liquid fire bomb or any other device or missile which can be ignited and cause ignition of any premises or material or which can cause damage by explosion.

S. Abuse or Interference With Kenosha Police Department Dogs. Willfully or maliciously tortures, beat, kick, strike, mutilate, injure, disable or kill any dog used by the Police Department of the City of Kenosha in the performance of the functions of such department, or to interfere with or meddle with any such dog while being used by said department or any officer or member thereof in the performance of any of the functions or duties of said department, or of such member or officer.

T.1. Hunting. Carry or have under his control any pistol, gun, or other firearm, for the purpose of hunting unless said firearm is unloaded, knocked down or enclosed in a suitable container. Subject to the exception in Subparagraph 11.02 T.2., this Ordinance shall be deemed to prohibit hunting within the City of Kenosha.

2. Shooting or Discharging a Bow and Arrow or Crossbow.

a. Subject to the regulations of this subparagraph 2., a person may hunt in the City of Kenosha while using a bow and arrow or crossbow.

b. It shall be unlawful for a person to hunt with a bow and arrow or crossbow within a distance of one hundred (100) yards from a building located on another person's land. This restriction shall not apply if the person who owns the land on which the building is located allows the hunter to hunt with a bow and arrow or crossbow within the specified distance of the building. "Building" for purposes of this subparagraph 2 means a permanent structure used for human occupancy and includes a manufactured home, as defined in §101.91 (2), Wisconsin Statutes.

c. A person who hunts with a bow and arrow or crossbow shall discharge the arrow or bolt from the weapon toward the ground.

d. No person may discharge an arrow with any bow or similar device or bolt from a crossbow where the arrow or bolt may endanger the life, limb or property of another or will traverse any part of any street, alley, public grounds or parks.

CODE OF GENERAL ORDINANCES, 2021 - KENOSHA, WISCONSIN

U. Littering. Throw, place or deposit any paper, glass, bottle, cans, containers, grass clippings, rubbish, waste, filth or other debris upon private property without consent of the owner or occupant, or upon the streets, alleys, highways, sidewalks, parks, or beaches, or into any pond, stream, river or lake.

V. Battery. Cause bodily harm to another by any act done with intent to cause bodily harm to that person or another without the consent of the person so harmed.

W. Theft. Intentionally take and carry away, use, transfer, conceal, or retain possession of movable property of another, the value of which does not exceed Three Hundred (\$300.00) Dollars without his/her consent and with intent to deprive the owner permanently of possession of such property.

No person shall aid, abet or conspire with another to intentionally take and carry away, use, transfer, conceal or retain possession of movable property of another, the value of which does not exceed Three Hundred (\$300.00) Dollars, without his/her consent, and with intent to deprive the owner permanently of possession of such property.

X. Schools.

1. It shall be unlawful, except as herein provided, for any person to remain in any public school building within the City without obtaining permission therefor immediately upon entering the building from the school principal, superintendent of schools or designee, which permission shall authorize the holder thereof to conduct official or personal business within the building or a designated portion thereof for a given period of time on the day designated within the scope of the permission. Students attending said school are exempted from this requirement as are parents of students enrolled in the school, School Board members, teachers and other employees of said school district. Permission may be denied where the need for the permission does not outweigh the disruption of school or school authorized business which would or may be caused if the permission were to be granted. This Subsection shall be applicable only in those school systems wherein the School Board or other governing body has approved the application of this Ordinance, and where notice of this Ordinance and the school system's acceptance of the same has been posted in a prominent place at all school entrances intended for the use of the public. Law enforcement officers shall be authorized to remove from the school buildings any persons who fail to comply with the terms of this Subsection and who fail to voluntarily leave the premises upon the request of the school principal, superintendent, or designee, or of any police officer. Upon conviction, violators shall be subjected to a forfeiture, and imprisonment for nonpayment thereof, pursuant to **§11.16(1)**, Ordinances, and minors shall be prosecuted through either the Juvenile Court system or the Municipal Court, whichever may be applicable.

2. It shall be unlawful, except as herein provided, for any person between the hours of 10:00 P.M. and 6:00 A.M., to enter into and remain on any public school grounds within the City without obtaining a written permit from the school principal, Superintendent of Schools, or designee, which permit shall authorize the holder thereof to conduct school or school authorized business on the school grounds for a given period of time on the day designated without the permit. The following persons are exempt from this permit requirement: School Board members, the teachers and administrators of the school, employees of the school, maintenance and construction personnel performing work for the school, and persons authorized for the conduct of said business. This Subsection shall be applicable only in those school systems wherein the School Board or other governing body has approved the applications of this Ordinance, and where notice of this Ordinance and the school system's acceptance of the same has been posted in a prominent place at all entrances to fenced in enclosures, and every three hundred (300') feet where there is no fenced in enclosure. Law enforcement officers shall be authorized to remove from the school grounds any person(s) who fail to comply with the terms of this Subsection and who fail to voluntarily leave the premises upon request. Upon conviction, violators shall be subjected to a forfeiture, and imprisonment for nonpayment thereof, pursuant to §11.16(1), Ordinances, and minors shall be prosecuted through either the Juvenile Court system or the Municipal Court, whichever may be applicable.

3. Any person who is on school grounds subject to Subsection 2. hereof, and posted as such, may

CODE OF GENERAL ORDINANCES, 2021 - KENOSHA, WISCONSIN

be asked by any school principal or designee or law enforcement officer as to his or her business for being thereon. Any person who fails to show that they are on school grounds for bona fide reasons may be asked to leave said premises forthwith. Any person who fails to leave school grounds promptly upon request shall be unlawfully upon said school grounds and shall be in violation of this Subsection, and law enforcement officers may remove said person from said school grounds. Violators shall, upon conviction thereof, be subjected to a forfeiture, and imprisonment for nonpayment thereof, pursuant to **§11.16(1)**, Ordinances and minors shall be prosecuted through either the Juvenile Court system or the Municipal Court, whichever may be applicable.

Y. Trespass, Delivery Personnel. Use other than sidewalks and areas designated as walkways by the owner or occupant while making deliveries upon private property, unless the owner or occupant provides permission to the contrary.

Z. Vandalism. Intentionally cause damage to any physical property of another, the value of which does not exceed \$300.00, without the person's consent. "Value" as used in this Subsection means the amount it would cost to repair or replace the physical property, whichever is less.

11.021 INTIMIDATION OF PUBLIC OFFICIALS

A. Definitions. In this section:

1. Employee of the County of Kenosha or City of Kenosha means an elected public official of the County of Kenosha or City of Kenosha, a former elected political official of the County of Kenosha or City of Kenosha, an appointed public official of the County of Kenosha or City of Kenosha, or a person publicly-employed by the County of Kenosha or City of Kenosha.

2. Family member means a parent, spouse, sibling, child, stepchild, or foster child.

3. Official Capacity means the status of taking action or contemplating taking action, under color of public office or public employment.

4. Threat means a communication that is made by express statement or is implied from conduct that the communicator may cause bodily harm to another.

5. Threaten means to communicate a threat.

B. Prohibition. No person may cause bodily harm or threaten to cause bodily harm to the person or family member of any employee of the County of Kenosha or City of Kenosha under all of the following circumstances.

1. At the time of the act or threat, the actor knows or should have known that the victim is an employee of the County of Kenosha or City of Kenosha or a member of his or her family; and

2. The employee of the County of Kenosha or City of Kenosha is either: (1) acting in an official capacity at the time of the act or threat or (2) the act or threat is in response to any action taken in an official capacity or (3) the act or threat is made to knowingly prevent or dissuade, or attempt to so knowingly prevent or dissuade an employee from doing his or her official duty; and

3. There is no consent by the person harmed or threatened.

C. Penalties. Any person who violates any provision of this Section shall, upon conviction thereof, be subject to a forfeiture not to exceed Ten Thousand Dollars (\$10,000.00), together with the costs of prosecution, and in default of payment thereof, shall be committed to the County jail for a period not to exceed ninety (90) days.

11.022 TRESPASS

It shall be unlawful for any person to enter or remain upon the property of another for a nonessential and/or nonauthorized purpose when such person has been informed through a posted sign, or otherwise, that such entry is prohibited during all or specified times, without the advance consent of the owner or occupant of the property to which entry is desired. Where signs are utilized to notify persons of prohibited

CODE OF GENERAL ORDINANCES, 2021 - KENOSHA, WISCONSIN

or restricted access to certain property, signs shall be conspicuously posted at the front and rear of property which is less than one (1) acre in size, and signs as to property over an acre in size shall be posted on all four (4) sides thereof, at intervals of not greater than one thousand (1,000) feet. Such signs shall be at least eleven (11) inches square (121 square inches) in size, with the wording describing the prohibited or restricted access being in letters no smaller than one-half (1/2") inch in size.

11.023 ELECTRONIC COMMUNICATION

A. Definitions for purposes of this section:

1. **"Caller Identification Information"** means a telephone number or a personal or business name associated with a telephone utility account.

2. **"Electronic Communication"** shall mean the transmission of sound, images, data or messages which includes, but is not limited to, email, text messaging, instant messaging and social networking websites by means of an Electronic Communication device.

3. **"Electronic Communication Device"** shall mean a device capable of transmitting and/or receiving Electronic Communication.

4. **"Emulate Caller Identification"** means to cause the recipient of an electronic communication to receive Caller Identification Information that is incorrect.

B. It shall be unlawful for any person to do any of the following by means of electronic communication originating within or received within the limits of the City:

1. Make any unwelcome request, suggestion or proposal which is obscene, lewd, lascivious, filthy or indecent.

2. Make contact on one or more occasions, whether or not conversation or dialogue ensues, with the intent to abuse, threaten, or harass any person.

3. Intentionally Emulate Caller Identification information.

C. It shall be unlawful for any person, party, firm or corporation to knowingly permit any Electronic Communications Device under their control to be used in a manner prohibited by this Ordinance.

D. It shall be unlawful to act in conspiracy or concert with another to do any acts contrary to this Ordinance.

11.024 CONTROL OF DOGS PURSUANT TO ORDER OF EMERGENCY PERSONNEL

Whenever any law enforcement officer, firefighter or rescue squad personnel orders a person to take specific or general action to control a dog owned, or under the care, custody or control of said person, at the scene of an emergency, at the scene of what is believed to be an emergency by any of said above listed emergency personnel giving said order, or at the scene of any law enforcement activity, so as to prevent said dog from actually or possibly hindering or obstructing an emergency or law enforcement operation, and said person fails to obey said order, this Ordinance shall be deemed to have been violated, irrespective of whether or not said dog did actually hinder or obstruct said emergency or law enforcement operation.

11.025 SOCIAL HOST

A. **Purpose and Findings.** The Common Council of the City of Kenosha intends to discourage underage possession and consumption of alcohol, even if done within the confines of a private residence, and intends to hold persons civilly responsible who host events or gatherings where persons under 21

CODE OF GENERAL ORDINANCES, 2021 - KENOSHA, WISCONSIN

years of age possess or consume alcohol regardless of whether the person hosting the event or gathering supplied the alcohol. The Common Council of the City of Kenosha finds:

1. Events and gatherings held on private or public property where alcohol is possessed or consumed by persons under the age of twenty-one are harmful to those persons and constitute a potential threat to public health requiring prevention or abatement.

2. Prohibiting underage consumption acts to protect underage persons, as well as the general public, from injuries related to alcohol consumption, such as alcohol overdose or alcohol related traffic collisions.

3. Alcohol is an addictive drug which, if used irresponsibly, could have drastic effects on those who use it as well as those who are affected by the actions of an irresponsible user.

4. Often, events or gatherings involving underage possession and consumption occur outside the presence of parents. However, there are times when the parent(s) is/are present and condone the activity, and in some circumstances, provide the alcohol.

5. A deterrent effect will be created by holding a person responsible for hosting an event or gathering where underage possession or consumption occurs.

B. Definitions. For purposes of this chapter, the following terms have the following meanings:

1. **Alcohol.** "Alcohol" means ethyl alcohol, hydrated oxide of ethyl, or spirits of wine, whiskey, rum, brandy, gin or any other distilled spirits including dilutions and mixtures thereof from whatever source or by whatever process produced.

2. **Alcoholic Beverage.** "Alcoholic beverage" means alcohol, spirits, liquor, wine, beer and every liquid or solid containing alcohol, spirits, wine or beer, and which contains one-half of one percent or more of alcohol by volume and which is fit for beverage purposes either alone or when diluted, mixed or combined with other substances.

3. **Event or Gathering.** "Event or gathering" means any group of three or more persons who have assembled or gathered together for a social occasion or other activity.

4. **Host or Allow.** "Host" or "allow" means to aid, conduct, entertain, organize, supervise, control or permit a gathering or event.

5. **Parent.** "Parent" means any person having legal custody of a juvenile:

(a) As natural, adoptive parent or step-parent;

(b) As a legal guardian; or

(c) As a person to whom legal custody has been given by order of the Court.

6. **Residence, Premises or Public or Private Property.** "Residence", "premises", or "public or private property" means any home, yard, farm, field, land, apartment, condominium, hotel or motel room or other dwelling unit, or a hall or meeting room, park or any other place of assembly, whether occupied on a temporary or permanent basis, whether occupied as a dwelling or specifically for a party or other social function, and whether owned, leased, rented or used with or without permission or compensation.

7. **Underage Person.** "Underage person" is any individual under twenty-one (21) years of age.

8. **Present.** Being at hand or in attendance.

CODE OF GENERAL ORDINANCES, 2021 - KENOSHA, WISCONSIN

9. In Control. The power to direct, manage, oversee and/or restrict the affairs, business or assets of a person or entity.

C. Prohibited Acts. It is unlawful for any person(s) to: host or allow an event or gathering at any residence, premises or on any other private or public property where alcohol or alcoholic beverages are present when the person knows that an underage person will or does consume any alcohol or alcoholic beverage; or possess any alcohol or alcoholic beverage with the intent to consume it; and the person fails to take reasonable steps to prevent possession or consumption by the underage person(s).

1. A person is responsible for violating this section if the person intentionally aids, advises, hires, counsels or conspires with or otherwise procures another to commit the prohibited act.

2. A person who hosts an event or gathering does not have to be present at the event or gathering to be responsible.

D. Exceptions.

1. This chapter does not apply to conduct solely between an underage person and his or her parents while the parent is present and in control of the underage person.

2. This chapter does not apply to legally protected religious observances.

3. This chapter does not apply to situations where underage persons are lawfully in possession of alcohol or alcoholic beverages during the course and scope of employment.

E. Penalties. A person who violates any provision of this ordinance is subject to a forfeiture of not less than \$1,000 nor more than \$5,000, together with the costs of prosecution. A person who is in default of payment is subject to imprisonment in the county jail until the forfeiture and costs are paid

11.026 PROHIBITING THE DRINKING OF INTOXICANTS ON PUBLIC STREETS AND SIDEWALKS, OR WITHIN ANY PARKED MOTOR VEHICLE

A. It shall be unlawful for any person to sell or serve or give to another person, or offer to sell or serve or give to another person any fermented malt beverage or intoxicating liquor while upon any public street or sidewalk, or within a parked motor vehicle located on any street within the City of Kenosha.

B. Unless otherwise properly licensed, It shall be unlawful for any person to consume any fermented malt beverage or intoxicating liquor or to possess the same in other than a sealed container while upon any public walk, street, public park, other public place in the City or over which the City has any lease or jurisdiction, on any parking lot open to and available to the public, or within a parked vehicle located on any street within the City of Kenosha.

However, the sale, service, giving away and consumption of fermented malt beverages, where authorized under City and State law, is permitted upon City streets and sidewalks where said areas are blocked off and in use for a street party authorized under §5.04 B., Ordinances, or where said activity is associated with a community event and where a Special Class "B" Fermented Malt Beverage License has been granted and issued, and where a permit therefor is reviewed by the Committee on Licensing/Permits and approved by the Common Council. Any permit issued must particularly describe the area in which said activity will be permitted and temporary signs must be posted within the permit area informing the public of the terms and limitations of the permit.

C. Intoxicants Permitted On City Sidewalks In An Outdoor Dining Area. The sale, service, giving away and consumption of intoxicants is permitted upon City sidewalks in an Outdoor Dining Area authorized and subject to a Permit under Section 5.046 of the Code of General Ordinances.

CODE OF GENERAL ORDINANCES, 2021 - KENOSHA, WISCONSIN

D. Underage Persons Under the Influence Prohibited.

1. No underage person as defined in Section 125.02(20m), Wisconsin Statutes, shall be under the influence of alcohol in the City of Kenosha. Such prohibition is subject to the exceptions in Section 125.07(4)(b), Wisconsin Statutes.

2. For the purpose of this section "under the influence" shall mean any underage person who exhibits one or more of the following indicators:

- (a) odor of intoxicants on the breath;
- (b) bloodshot eyes;
- (c) dilated pupils;
- (d) unstable balance;
- (e) slurred speech;
- (f) failure of Standard Field Sobriety Test; and
- (g) admission to consumption of alcohol.

11.027 SERVICE STATIONS

A. Purpose. The purpose of this Ordinance is to reduce the number of service station robberies and thereby safeguard the health, safety and welfare of service station patrons and attendants during those evening hours when such robberies are most likely to occur. The primary hours of concern to law enforcement authorities are the hours of 8:00 P.M. to 8:00 A.M.; however, the restrictions of this Ordinance include only the hours of 9:00 P.M. to 7:00 A.M., so as to impose as little burden as possible on service stations which are not open throughout the night but which may close their workday at 9:00 P.M. and open at 7:00 A.M.

B. Restriction. No service station shall be or remain open, within the City, during the hours of 9:00 P.M. through 7:00 A.M., or any portion thereof, unless said service station shall have a safety deposit box on the premises which cannot be opened by the attendant on duty, and which is permanently attached, and not readily removable from the premises, into which box cash from all sales during said hours must be deposited by the attendant on duty immediately after said sale is consummated.

C. Definition. Service stations shall be defined herein as a business involving primarily the sale of gasoline and diesel fuel for motor vehicles, and the sale of any products or services incidental to the operation of a motor vehicle, and the sale of any groceries or merchandise conducted while the station is otherwise open for business.

D. Permit. No service station shall be or remain open during the hours of 9:00 P.M. to 7:00 A.M., after May 1, 1977, without first obtaining a permit from the City Clerk which shall be issued without the payment of a fee. The City Clerk shall not issue said permit until the application which shall be upon a form supplied by the City Clerk, shall be sent to the Police Department for an inspection of the premises, and report thereon for the purpose of determining whether a proper safety deposit box has been installed as heretofore required.

E. Penalty. Any person, party, firm or corporation who shall operate a service station in a manner contrary to the provisions of this Ordinance shall be subject to a fine of \$25 per day, each day constituting a separate violation, and the payment of costs and prosecution, and in default of payment of such fine and costs, shall be committed to the County Jail for a period not to exceed thirty (30) days.

11.028 PARENTAL RESPONSIBILITY

A. Purpose. Juvenile acts causing injury to persons and damage to property are of vital concern to the citizens of Kenosha, and it is the declared policy of this City that parental responsibility must be encouraged to effectively control or eliminate juvenile offenses. The purpose of this Ordinance is to encourage parental responsibility and to penalize those that fail to exercise said responsibility.

B. Definitions.

1. "**Minor**" means a person who is above the age of seven (7) years, but not yet eighteen (18) years

CODE OF GENERAL ORDINANCES, 2021 - KENOSHA, WISCONSIN

of age.

2. "Legal Guardian" means a person appointed guardian or given custody of a minor child by a Court of record.

C. Prohibition. The parent or legal guardian of an unemancipated minor residing with such parent or legal guardian shall be presumed, in the absence of evidence to the contrary to have failed to exercise proper parental responsibility and said minor shall be deemed to have committed the acts described below with the knowledge and permission of the parent or guardian, in violation of this Ordinance, upon the occurrence of the events described in 1., 2. and 3. below:

1. An unemancipated minor residing with said parent or legal guardian shall either be adjudicated to be in violation of any Ordinances, law or statute prohibiting willful and malicious acts causing injury to a person or property, or shall have incurred nonjudicial sanctions from another official agency resulting from an admission of guilt of violation of any Ordinance, law or statute prohibiting willful and malicious acts causing injury to a person or property; and,

2. Said parent or legal guardian shall have received a written notice thereof, either by certified or registered mail, return receipt requested, or by personal service, with a certificate of personal service returned from the Police Department of the City of Kenosha, Wisconsin, following said adjudication or nonjudicial sanction; and

If at any time within one (1) year following receipt of the notice set forth in **2.** above, said minor is either adjudicated to be in violation of any Ordinance, law or statute as described in **1.** above, or shall have incurred nonjudicial sanctions from another official agency resulting from an admission of guilt of violation or any Ordinance, law or statute as described in **1.** above.

D. Penalty. Any person convicted for a violation of this Ordinance shall be fined not less than Twenty-Five (\$25.00) Dollars, nor more than Five Hundred (\$500.00) Dollars for each offense, and costs of prosecution, and in default of payment of the same, shall be committed to the County Jail for a period not to exceed ten (10) days.

11.029 FALSE POLICE ALARMS

A. Prohibition. It is unlawful for any person within the City, to knowingly call the City Police Department, or any other law enforcement agency for police assistance when there is no matter requiring official action by said City Police Department or other law enforcement agency.

B. Penalty. Any person convicted for a violation of this Ordinance shall forfeit not more than Five Hundred (\$500) Dollars for each offense, plus the costs of prosecution, and in default of payment thereof, shall be committed to the County Jail for a period not to exceed thirty (30) days.

11.03 PROVISIONS OF STATE PROSTITUTION SUBCHAPTER ADOPTED BY REFERENCE

A. State Prostitution Law Adopted. All provisions of Chapter 944, Subchapter V Prostitution, Sections 944.30 to 944.36, of the Wisconsin Statutes describing and defining regulations with respect to prostitution, exclusive of the penalties provided therein, are hereby adopted and by reference are made a part of this Section as if fully set forth herein. Any future amendments, revisions or modifications of the Statutes incorporated herein are intended to be made part of this Code.

B. Penalty. Any person found violating this section shall upon conviction be punished by a forfeiture not less than \$500.00 nor more than \$1,000.00, together with the costs of prosecution and all applicable fees and surcharges, and in default thereof shall be committed to the County Jail for a period not to exceed ninety (90) days.

11.031 GRAFFITI

A. Purpose. The purpose of this Ordinance is to reduce the potential for blight and gang violence.

B. Definitions. The following words shall, for purposes of this Ordinance, have the meanings

CODE OF GENERAL ORDINANCES, 2021 - KENOSHA, WISCONSIN

provided:

1. Deface(ing)(ment) shall mean to mar or disfigure the face or surface by cutting, engraving, inscribing, chipping, painting or otherwise marking in some permanent manner.

2. Graffiti shall mean marks, symbols, signs, letters, names, phrases, or sentences which are inscribed or placed on real property for the purpose of defacing said property or making a personal statement which is a blighting influence on the neighborhood.

3. Permanent shall mean not being capable of being removed with soap and water. Cutting, engraving, inscribing, chipping and painting shall be deemed permanent.

4. Real Property shall mean a building, structure, garage, shed, fence, deck or other improvement to a parcel of land.

5. Reasonable Time shall mean fifteen (15) days from the posting of the property, unless a greater period of time is warranted by weather conditions, in which event reasonable time shall mean as soon as possible, subject to the potential for a time extension under C.3.

6. Remove(al) shall mean to obliterate and eliminate graffiti by such means as will restore real property to its condition existing prior to defacement by graffiti.

C. Prohibition.

1. It shall be unlawful for any person to deface real property which they do not own with graffiti.

2. It shall be unlawful for any person to place graffiti or to permit graffiti to be placed upon real property which they own.

3. It shall be unlawful for the owner of real estate to fail to remove graffiti from their real property within a reasonable time, as determined by the Department of City Inspections, upon being provided a written notice thereof and order for removal by a date certain served upon them by personal service or by regular mail, sent to the address listed on their real estate tax bill, and by posting the order on the real property. Upon written request received by the Department of City Inspections prior to the expiration of the time provided for compliance, the Director of the Department of City Inspections may, for just cause, grant an extension of time for compliance. Each day of violation shall be a separate offense.

11.032 TRUANCY

Pursuant to Section 118.163, Wisconsin Statutes, as may be amended from time to time, any person under the age of 18 years of age found to be a habitual truant, as that term is defined under Section 118.16, Wisconsin Statutes, shall be subject to any of the following dispositions which are deemed to be available to the Municipal Court:

1. Suspension of the person's operating privileges for not less than thirty (30) days, nor more than one (1) year. The Court shall immediately take possession of any suspended license and forward it to the Department of Transportation, together with a notice stating the reason for and the duration of the suspension

2. An order for the person to participate in counseling or a supervised work program or other community service work as described in Section 938.34(5g), Wisconsin Statutes. The costs of any such counseling, supervised work program or other community service work may be assessed against the person, the parents or guardian of the person, or both.

CODE OF GENERAL ORDINANCES, 2021 - KENOSHA, WISCONSIN

3. An order for the person to remain at home except during hours in which the person is attending religious worship or a school program, including travel time required to get to and from the school program or place of worship. The order may permit a person to leave his or her home if the person is accompanied by a parent or guardian.

4. An order for the person to attend an educational program as described in Section 938.34(7d), Wisconsin Statutes.

5. An order for the Department of Workforce Development to revoke, under Section 103.72, Wisconsin Statutes, a permit issued under Section 103.70, Wisconsin Statutes, authorizing the employment of the person.

6. An order for the person to be placed in a teen court program as described in Section 938.342(1g)(f), Wisconsin Statutes.

7. An order for the person to attend school.

8. A forfeiture of not more than Five Hundred (\$500.00) Dollars, plus costs, subject to Section 938.37, Wisconsin Statutes. All or part of the forfeiture, plus costs, may be assessed against the person, the parents or guardian of the person, or both.

9. Any other reasonable conditions consistent with Subsection 118.163(2), Wisconsin Statutes, including a curfew, restrictions as to going to or remaining on specified premises, and restrictions on associating with other children or adults.

10. An order placing the person under formal or informal supervision, as described in Section 938.34(2), Wisconsin Statutes, for up to one (1) year.

11. An order for the person's parent, guardian or legal custodian to participate in counseling at the parent's, guardian's or legal custodian's own expense, or to attend school with the person, or both.

12. An order for the person to report to a youth report center after school, in the evening, on weekends, on other non-school days, or at any other time that the person is not under immediate adult supervision, for participation in the social, behavioral, academic, community service, and other programming of the center as described in Section 938.342 (1g)(k), Wisconsin Statutes.

11.033 SEXUAL OFFENDER RESIDENCY RESTRICTIONS

A. Findings and Intent.

1. **Findings.** Repeat sexual offenders, sexual offenders who use physical violence, and sexual offenders who prey on children are sexual predators who present an extreme threat to the public safety. Sexual offenders are extremely likely to use physical violence and to repeat their offenses; and, most sexual offenders commit many offenses, have many more victims that are never reported, and are prosecuted for only a fraction of their crimes. This makes the cost of sexual offender victimization to society at large, while incalculable, clearly exorbitant. Therefore, the City being concerned about public safety and, in particular, the safety of children finds:

a. Regulation of sex offender residency is not an issue unique to the City of Kenosha; to the contrary, virtually all, if not literally all, of the municipalities in the greater Milwaukee area regulate sex offender residency, and this is consistent with comparable regulations that, while not universally adopted, are very common throughout the State of Wisconsin and nationwide.

b. The City now intends to revisit its regulation of sex offender residency, in light of assertions which challenge the City's regulation of sex offender residency.

c. In revisiting the matter the City hereby intends to, and does, reconsider the whole issue, from its most basic premises, to ensure that the regulations are tailored to the circumstances of the City, while

CODE OF GENERAL ORDINANCES, 2021 - KENOSHA, WISCONSIN

preserving the intent to promote public safety particularly to protect children from potential recidivism of convicted child sex offenders.

d. In revisiting the matter, the City again observes the risks posed by sex offenders against children, which risks are nationally recognized in such landmark legislation as the 1994 Jacob Wetterling Crimes Against Children and Sexually Violent Offender Registration Act; 1996 Megan's Laws; and the 2006 Adam Walsh Child Protection and Safety Act; and these risks are also recognized by legislation in every State in the United States of America including Wisconsin.

e. The City finds that the data concerning child sex offenders demonstrates the need for action, including the following:

- "sex crimes are unfortunately fairly common in the United States."
- "It is estimated that one in every five girls and one in every seven boys are sexually abused by the time they reach adulthood."
- "Children are particularly vulnerable. Approximately 67% of all victims of reported sexual assaults are under the age of 18, and more than half of these victims are under the age of 12."
- "Most sexual offenses are committed by someone the victim knows ... or acquaintance."
- "No single factor or combination of factors can fully explain why someone offends sexually, though some factors may combine to increase people's tendency to offend. These factors are [physiological, sociocultural, developmental] and situational/circumstantial (e .g. having easy access to victims...)."
- "About 12% to 24% of sex offenders will reoffend."

f. The City also finds these statistics of the U.S. Department of Justice to be disturbing and a call to action.

- "Approximately 1.8 million adolescents in the United States have been victims of sexual assault."
- "An estimated 60% of perpetrators of sexual abuse are known to the child but are not family members, e .g. family friends, babysitters, child care providers, neighbors."

g. The City is not inclined to sit idly by and do nothing to protect children within the City when these most vulnerable members of our community face these documented threats from offenders who are highly prone to re-offend if given the opportunity to do so.

h. The City is aware of many studies and reports concerning recidivism of sex offenders and the effectiveness of sex offender residency restrictions.

i. The City acknowledges that literature on the subject includes studies that support the practice of imposing sex offender residency restrictions and others that are critical of the practice.

j. The City finds it significant that some key studies concluding sex offender residency restrictions have limited effectiveness have added significant qualifications to that conclusion; e.g. in "An Evaluation of Sex Offender Residency Restrictions In Michigan and Missouri," (Huebner, et al., 2013), the authors generally do not support sex offender residency restrictions, but nevertheless find that following adoption of sex offender residency restrictions "the rate of recidivism for technical violations significantly decreased for Missouri sex offenders ... " (id. at 9) and "the number of sex offense convictions did decline ... " in Missouri (id. at 10).

k. The City recognizes the merits, mentioned in some studies, of individualized consideration of the risks and benefits of residency restrictions on an offender by- offender basis, therefore the City intends to allow for individualized consideration through an exemption process.

l. The City acknowledges that many communities have an "original domicile reits own sex offenders to its community; such burdens including neighborhood and citizen concerns and responses, risks of recidivism, and potential property value impacts.

m. The City believes that absent an original domicile restriction, the City would have open doors for non-resident sex offender residency when other communities have closed doors, inviting a substantial increase in child sex offender placements, with the related adverse impacts on the health, safety and welfare of the City and its residents.

n. The City finds that is necessary and appropriate to distinguish between offenders who were residents at the time of their offense and those who were not, for numerous reasons including the following:

- Offenders who were residents of the City at the time of the offense are known to City law enforcement which allows for improved community relations, monitoring and enforcement;

CODE OF GENERAL ORDINANCES, 2021 - KENOSHA, WISCONSIN

- Offenders who were residents of the City at the time of their offense are familiar with the City and therefore are better able to know the locations within the City where children and youth are likely to congregate, to better avoid those locations and reduce the opportunities for re-offense;
 - Offenders who were residents of the City at the time of their offense have paid property taxes either directly or indirectly, and are a part of the community, and have some level of investment backed expectations of continued participation in the community; and
 - Offenders who were residents of the City at the time of their offense have a pre-established connection with the community, which provides a stronger social network reducing the risks of social isolation and making it more likely for such residents to reintegrate and become productive members of the community.
- o. The City is unaware of any circumstance where a Designated Offender who having prior to the Effective Date of this Ordinance, established a Permanent Residence or Temporary Residence that was reported and registered pursuant to Section 301.45, Wisconsin Statutes, has reoffended.
- p. The City believes that for all but the most severe offenders, this risk of adverse impact declines as time passes following the date of a Designated Offender's offense, as the offender matures, recovers and reintegrates with society over time; and if this results in the offender being removed from the State registration list, the offender is thereby automatically removed from the City residency restrictions; but even if State registration is required, once ten years has passed from the date of the most recent offense giving rise to the Designated Offender designation, provided it is not a Class A felony against a child, the City finds it is appropriate to remove the original domicile restriction and allow such reformed citizen to move into the City in compliance with this ordinance; and by opening this door the City hopes that it is establishing a precedent for its surrounding communities to open their doors as well.
- q. The City recognizes that it cannot eliminate all risk of child sex offender re-offense, and it must balance all of the competing public policies, but intends by these regulations to strike the legislative balance that is appropriate for the circumstances of the City of Kenosha.
- r. It is not the intent of this ordinance to banish sex offenders from residing within the City, and careful attention has been given to ensure that there are ample locations for sex offenders to reside within the City in compliance with the requirements of this ordinance.
- s. In reconsidering the matter, having given the matter due consideration, and having based its determination on the effect of the amendments on the health, safety and welfare of the community and the immediate neighborhoods affected and the current and future City residents who are child sex offenders, and having given due consideration to the municipal problems involved, it is determined that the amendments to the Ordinance will appropriately support the public health, safety and general welfare of the City and will not be hazardous, harmful, noxious, offensive or for any other reason cause a substantial adverse effect on the property values and general desirability of City neighborhoods.

2. Intent. It is the intent of this Ordinance not to impose a criminal penalty, but rather to service the City of Kenosha's compelling interest to promote, protect and improve the health, safety and welfare of the citizens of the City of Kenosha by creating areas around locations where children regularly congregate in concentrated numbers wherein certain sexual offenders and sexual predators are prohibited from establishing temporary or permanent residency.

B. Definitions. The following words, terms and phrases, when used in this Ordinance, shall have the meanings ascribed to them in this Section, except when the context clearly indicates a different meaning.

1. **"Child"** means a person under the age of sixteen (16) years for purposes of this Ordinance.
2. **"Designated Offender"** means any person who is required to register under Section 301.45, Wisconsin Statutes, for any sexual offense against a child, or any person who is required to register under Section 301.45, Wisconsin Statutes, and who has been designated a Special Bulletin (SBN) sex offender pursuant to Sections 301.46(2) and (2m), Wisconsin Statutes.
3. **"Minor"** means a person under the age of seventeen (17) years.

CODE OF GENERAL ORDINANCES, 2021 - KENOSHA, WISCONSIN

4. **"Permanent Residence"** means a place where the Designated Offender lodges or resides for fourteen (14) or more consecutive days.

5. **"Temporary Residence"** means either: **(a)** a place where the person abides, lodges or resides for a period of fourteen (14) or more days in the aggregate during any calendar year and which is not the person's permanent address; or, **(b)** a place where the person routinely abides, lodges or resides for a period of four (4) or more consecutive or nonconsecutive days in any month and which is not the person's Permanent Residence.

6. **"Prohibited Location"** means any school property, licensed daycare center, park, place of worship, or youth center. The City Administrator shall maintain an official map showing the prohibited locations within the City. The City Administrator shall update the map at least annually to reflect any changes in the prohibited locations. The map shall be available in the office of the City Clerk and posted on the City website.

C. Designated Offender Residence; Prohibitions and Exceptions.

1. Prohibited Location of Residence.

a. Except as otherwise provided in this Ordinance, it is unlawful for any Designated Offender to establish a Permanent Residence or Temporary Residence within one thousand (1,000) feet of a Prohibited Location.

b. Except as otherwise provided in this Ordinance it shall be unlawful for any Designated Offender to establish a Permanent Residence or Temporary Residence within the City unless the Designated Offender was legally domiciled in the City at the time of the offense resulting in the person's most recent offense that qualifies for designation as a Designated Offender. This restriction, shall not apply if the Designated Offender's most recent conviction of an offense that is within the definition of Designated Offender occurred ten (10) or more years prior to taking occupancy within the City, provided the Designated Offender has not been convicted of a Class A felony against a child.

2. **Notification.** A Designated Offender must notify the Alderman of the District a minimum of three (3) days prior to establishing either a Permanent Residence or Temporary Residence within the City of Kenosha.

3. **Prohibited Activity.** It is unlawful for any Designated Offender to participate in a holiday event involving children under eighteen (18) years of age. Holiday events in which the offender is the parent or guardian of the children involved, and no nonfamilial children are present, are exempt from this Section. "Participation" is defined as actively taking part in the event and shall include, but is not limited to, distributing candy or other items to children on Halloween, wearing a Santa Claus costume on or preceding Christmas, or wearing an Easter Bunny costume on or preceding Easter.

4. **Determination of Minimum Distance Separation.** For purposes of determining the minimum distance separation, the requirement shall be measured by following a straight line from the closest point of the outer property line of the Permanent Residence or Temporary Residence of a Designated Offender to the nearest outer property line of a Prohibited Location.

5. **Exceptions.** A Designated Offender residing within a Prohibited Location as described in Section 11.033 B.1 shall not be in violation of this Ordinance if any of the following apply:

a. The Designated Offender established the Permanent Residence or Temporary Residence and reported and registered the residence pursuant to Section 301.45, Wisconsin Statutes, before the effective date of this Ordinance.

b. The Designated Offender is a minor and is not required to register under Sections 301.45 and 301.46, Wisconsin Statutes.

c. The Prohibited Location situated within one thousand (1,000) feet of the person's Permanent Residence was opened or established after the Designated Offender established the Permanent Residence or Temporary Residence and reported and registered the residence pursuant to Section 301.45, Wisconsin Statutes.

CODE OF GENERAL ORDINANCES, 2021 - KENOSHA, WISCONSIN

d. The residence is also the primary residence of the Designated Offender's parents, grandparents, siblings, spouse or children, provided that such parent, grandparent, sibling, spouse or child established the residence at least two (2) years before the Designated Offender established residence at the location. Notwithstanding the foregoing, a Designated Offender is prohibited from residing in such location if a victim of an offense giving rise to the Designated Offender's designation also resides in the residence and is a Minor, unless the Designated Offender is on probation or parole and residing with the victim with the written approval of the Designated Offender's probation or parole officer.

e. The Sex Offender Residence Board has granted an exemption for the Designated Offender.

6. Chapter 980 Preemption. To the extent required by Section 980.135 of the Wisconsin Statutes, and notwithstanding the provisions of this Ordinance, the City hereby exempts and may not enforce any provision thereof that restricts or prohibits a Designated Offender from residing at a particular location, or that restricts or prohibits a person from providing housing to a Designated Offender against an individual who is released under Section 980.08, Wis. Stats., or against a person who provides housing to such individual, so long as the individual is subject to supervised release under Chapter 980 of the Wisconsin Statutes, the individual is residing where he or she is ordered to reside under Section 980.08, Wis. Stats., and the individual is in compliance with all court orders issued under Chapter 980 of the Wisconsin Statutes.

D. Property Owners Prohibited From Renting Real Property To Designated Offenders. It shall be unlawful for any property owner to lease or rent any place, structure, mobile home, trailer or any part thereof, with the knowledge that it will be used as a Permanent Residence or Temporary Residence by any person prohibited from establishing a Permanent Residence or Temporary Residence therein pursuant to this Ordinance, if such place, structure, or mobile home, trailer or any part thereof, is located within a Prohibited Location zone as defined in Section 11.033 B.

E. Petition for Exemption.

1. A Designated Offender may seek an exemption from this Ordinance by petitioning to the Sex Offender Residence Board ("Board").

2. The Board shall consist of three citizens residing in the City. Members shall be selected by the Mayor subject to approval by the Common Council. Members shall serve for a term of five (5) years and shall serve no more than two (2) consecutive terms. The terms for the initial members of the Board shall be staggered with one member serving one (1) year, a second serving three (3) years and the third serving five (5) years.

3. The Board shall approve an official petition form. The Designated Offender seeking an exemption must complete the petition and submit it to the City Clerk who shall forward it to the Board. The Board shall hold a hearing on each petition, during which the Board may review any pertinent information and accept oral or written statements from any person. The Board shall base its decision on factors related to the City's interest in promoting, protecting and improving the health, safety and welfare of the community. Applicable factors for the Board's consideration shall include, but are not limited to:

- a. age of offense
- b. counseling, treatment and rehabilitation history of Designated Offender
- c. remorse of Designated Offender
- d. duration of time since Designated Offender's incarceration
- e. support network of Designated Offender
- f. relationship of Designated Offender and victim(s)
- g. presence or use of force in offense(s)
- h. adherence to terms of probation/parole

4. The Board shall decide by majority vote whether to grant or deny an exemption. An exemption may be unconditional or limited to a certain address or time. The Board's decision shall be final for purposes of any appeal. A written copy of the decision shall be provided to the Designated Offender and the Kenosha Police Department.

CODE OF GENERAL ORDINANCES, 2021 - KENOSHA, WISCONSIN

F. Severability. Should any section, paragraph, sentence, clause or phrase of this Section be declared unconstitutional or invalid, or be repealed, it shall not affect the validity of this Ordinance as a whole, or any part thereof, other than the part so declared to be invalid or repealed.

G. Penalties. Any person who violates any provision of this Section shall, upon conviction thereof, be subject to a forfeiture not to exceed Five Hundred (\$500.00) Dollars, together with the costs of prosecution, and in default of payment thereof, shall be committed to the County Jail for a period not to exceed ninety (90) days. Each day such violation continues shall be considered a separate offense.

H. Injunction. If a Designated Offender or property owner violates any provision of this Ordinance the City may, in addition to all other rights and remedies allowed by law or this Ordinance, bring an action in circuit court seeking a temporary restraining order, temporary injunction or permanent injunction against such Designated Offender or property owner to prevent them from violating the terms of this Ordinance or to take any action, or prevent any action, necessary for compliance with the terms of this Ordinance.

11.034 LOITERING-ILLEGAL DRUG ACTIVITY

A. Definitions. For purposes of this Ordinance:

1. **"Illegal drug activity"** means unlawful conduct contrary to any provision of Chapter 961, Wisconsin Statutes, or any substantially similar Federal Statute, Statute of a foreign state or Ordinance of any political subdivision.

2. **"Known area of illegal drug activity"** means a public place where, within three (3) years previous to the date of arrest for violation of this Section, and within the collective knowledge of the Police Department, a person has been arrested for a violation which led to a conviction in any municipal, State or Federal Court of an offense involving illegal drug activity.

3. **"Known drug seller or purchaser"** means a person who, within three (3) years previous to the date of arrest for violation of this Section, had within the collective knowledge of the Police Department been convicted in any municipal, State or Federal Court of an offense involving illegal drug activity.

4. **"Public place"** means an area generally visible to public view and includes, but is not limited to, streets, sidewalks, bridges, alleys, plazas, parks, driveways, parking lots and buildings open to the general public, including those which serve food or drink or provide entertainment, and the doorways and entrances to buildings or dwellings and the grounds surrounding them.

B. Prohibition. Any person who loiters or drives in any public place in a manner and under circumstances manifesting the purpose of inducing, enticing, soliciting or procuring another to engage in illegal drug activity shall be in violation of this Ordinance. Among the circumstances which may be considered in determining whether such purpose is manifested are the following: that the person frequents, either on foot or in a motor vehicle, a known area of illegal drug activity; repeatedly beckons to stop or attempts to stop known drug sellers or purchasers or engages known drug sellers or purchasers in conversation; stops the motor vehicle the person is the operator of and sells or purchases or attempts to sell or purchase illegal drugs to or from a known drug seller or purchaser; transfers small objects or packages for currency in a furtive fashion or manifestly endeavors to conceal himself, herself or any object or package which reasonably could be involved in illegal drug activity; takes flight upon appearance of a police officer. The violator's conduct must be such as to demonstrate a specific intent to induce, entice, solicit or procure another to engage in illegal drug activity. No arrest may be made for a violation of this Section unless the arresting officer first affords the person an opportunity to explain the person's presence and conduct, unless flight by the person or other circumstances make it impracticable to afford such an opportunity, and no one shall be convicted of violating this Section if it appears at trial that the explanation given was true and disclosed a lawful purpose.

CODE OF GENERAL ORDINANCES, 2021 - KENOSHA, WISCONSIN

11.035 DESIGNATION OF LOCATIONS WHERE LOITERING OR STANDING IS PROHIBITED UPON STREET MEDIANS

A. Definitions.

1. "Median" means a paved or unpaved area dividing a street or highway that separates lanes of traffic traveling in opposite directions.
2. **Loitering Prohibited.** No person may stand, sit or stay upon any median less than 5 feet wide, or any median in a designated roadway or highway that is considered a safety hazard for pedestrians. This provision does not apply to:
 - a. Persons using a crosswalk to cross a street.
 - b. Law enforcement officers or public employees acting within the scope of their duties.
 - c. Fire or emergency employees providing emergency assistance.
 - d. Street or utility construction and maintenance workers performing authorized construction or maintenance work.

3. **Penalty.** Any person found violating this section shall upon conviction be punished by a forfeiture not less than \$50 nor more than \$200, together with the cost of prosecution and all applicable fees and surcharges, and in default thereof shall be imprisoned as provided by law.

11.036 TRESPASS

A. Except as otherwise provided by law, no person shall be in or on any private property, land, dwelling or business establishment without the consent, express or implied, of the owner of said private property, land, dwelling or business establishment, or his agent or representative.

B. Except as otherwise provided by law, no person shall remain in or on any private property, land, dwelling or business establishment after consent to remain has been expressly withdrawn by the owner of said private property, land, dwelling or business establishment, or by his agent or representative.

C. Except as otherwise provided by law, no person shall enter any motor vehicle without the consent, express or implied, of the owner of said motor vehicle, or his/her agent or representative.

D. Except as otherwise provided by law, no person shall remain in any motor vehicle after consent to remain has been expressly withdrawn by the owner of said motor vehicle, or by his/her agent or representative.

E. Except as otherwise provided or prohibited by law, no person shall enter or remain in any residence, non single family residence, nonresidential building, the grounds or land related to the foregoing, special event, any part of a building that is owned, occupied, or controlled by the state or any local governmental unit, or, any privately or publicly owned building on the grounds of a university or college within the meaning of § 943.13 Wis. Stats., as amended, if the owner, occupant, organizer, state or local government unit, or university or college has notified the person as required by §943.13 Wis. Stats., as amended, not to enter or remain in or on the residence, building, grounds, land or special event while carrying, possessing or controlling a weapon as defined in §175.60(1)(j) Wis. Stats., or a dangerous weapon as defined in §§ 939.22 (10) and 948.60 (1), Wis. Stats., as maybe amend from time to time.

11.04 GAMBLING

A. **Forbidden.** No person shall keep any gambling resort, or keep or use any article or device for gambling purposes, or permit any person to gamble, bet or play for money or gain, with or by means of any such article or device, in any room or place under his control; nor shall any person gamble, bet or play for money or gain with or by means of any such article or device.

No person shall bet or wager any money or other thing of value upon the result of any trick, contested

CODE OF GENERAL ORDINANCES, 2021 - KENOSHA, WISCONSIN

skill, speed or bets of endurance of man or beast, or upon the result of any political nomination, appointment or election.

B. Seizure. The members of the Police Department are hereby authorized to seize and hold all gambling articles and devices found by them, and dispose of the same in accordance with the directions of the court.

C. This Section is not violated by activities and the devices authorized under the provisions of Chapter 563 of the Wisconsin Statutes - Regulation of Bingo.

11.05 CURFEW

No minor person under eighteen (18) years of age shall be in any public place between the hours of 10:30 P.M. and 6:00 A.M., Sunday through Thursday, and 12:00 Midnight to 6:00 A.M., Friday and Saturday, unless such minor is accompanied by an adult person having legal custody of such minor, or unless such minor is in the performance of an errand or a duty directed by the adult having legal custody of such minor, or whose employment makes it necessary for such minor to be in such public place. Unless there exists a reasonable necessity therefor, no person having legal custody of such minor shall permit said minor in any public place during the hours specified in the above paragraph.

This Ordinance shall not apply to minors fifteen (15) years of age or older returning home between the hours of 12:00 Midnight and 6:00 A.M. from functions authorized by the governing body of any public or parochial school, or any charitable or religious organization when such function shall have been officially registered with the Police Department by a responsible officer of the governing body of the school or religious or charitable organization at least two (2) weeks prior to the event. The School or charitable or religious organization which has registered the function with the Police Department shall assume the responsibility to provide each student with a positive means of identification showing that said minor has attended such registered function. This Section shall, similarly, not apply in circumstances in which the minor was exercising First Amendment rights protected by the United States Constitution or the Wisconsin Constitution, including freedom of speech, the free exercise of religion and/or the right of assembly. Unless flight by the minor or other circumstances make it impracticable, a peace officer shall, prior to issuing a citation for an offense under this Section, afford the minor an opportunity to explain his or her reasons for being present in the public place. A peace officer shall not issue a citation for an offense under this Section unless the officer reasonably believes that an offense has occurred, and that none of the exceptions to the curfew restriction described herein applies. All functions registered with the Police Department pursuant to this exemption shall be held on nights which are not followed by a regular school day and no such school or organization shall be allowed to have more than five (5) such events during a calendar year.

11.051 THEFT, DESTRUCTION, DEFACEMENT AND MUTILATION OF LIBRARY MATERIALS

A. Definitions.

1. **"Archives"** means a place in which public or institutional records are systematically preserved.
2. **"Library"** means any public library, library of an educational, historical, or eleemosynary institution, organization or society; archives; or museum.
3. **"Library Material"** includes any book, plate, picture, photograph, engraving, painting, drawing, map, newspaper, magazine, pamphlet, broadside, manuscript, document, letter, public record, microfilm, sound recording, audiovisual materials in any format, magnetic or other tapes, electronic data processing records, artifacts or other documentary written or printed materials, regardless of physical form or characteristics, belonging to, on loan to or otherwise in the custody of a library.
4. **"Destroy"** means to render Library material wholly unsuitable for its intended purpose.
5. **"Deface"** means the disfiguration, marring or soiling of Library materials or any other act which lessens the value of Library material, but which does not render Library material wholly or partially unsuitable for its intended purpose.
6. **"Mutilate"** means to render Library material partially unsuitable for its intended purpose, including, but not limited to, removing pages, covers, inserts or bindings from Library material or removing or concealing Library ownership labels, tags or stamps from Library material.
7. **"Take"** means to carry away, transfer, conceal or retain possession of any Library material to

CODE OF GENERAL ORDINANCES, 2021 - KENOSHA, WISCONSIN

deprive the Library thereof.

B. Prohibition. It shall be unlawful for any person to take, destroy, deface or mutilate any Library material without the consent of a Library official, agent or employee having jurisdiction thereof. Whoever intentionally takes and carries away, transfers, conceals or retains possession of any Library material without the consent of a Library official, agent or employee, and with intent to deprive the Library of possession of the material, may be subject to a forfeiture as provided by Section **11.051 E**.

C. Evidence of Intent. The concealment of Library material beyond the last station for borrowing Library material in a Library is evidence of intent to deprive the Library of possession of the material. The discovery of Library material which has not been borrowed in accordance with the Library's procedures or taken with consent of a Library official, agent or employee, and which is concealed upon the person or among the belongings of the person, or concealed by a person upon the person or among the belongings of another is evidence of intentional concealment on the part of the person so concealing the material. The possession of Library materials past the date due issued by the Library is additional evidence of intent to deprive the Library of possession of the material.

D. Detention of Suspected Violators. An official or adult employee or agent of a Library who has probable cause for believing that a person has violated this Section in his or her presence may detain the person in a reasonable manner for a reasonable length of time to deliver the person to a peace officer, or to the person's parent or guardian in the case of a minor. The detained person shall be promptly informed of the purpose for the detention and be permitted to make phone calls, but shall not be interrogated or searched against his or her will before the arrival of a peace officer who may conduct a lawful interrogation of the accused person. Compliance with this Subsection entitles the official, agent or employee effecting the detention to the same defense in any action as is available to a peace officer making an arrest in the line of duty.

E. Penalty. Any person who violates this Ordinance, upon conviction, shall forfeit not more than Two Hundred (\$200) Dollars, plus the cost of repair or replacement of material, if necessary, in addition to the costs of prosecution; and, in default of timely payment of such forfeiture, shall be committed to the Kenosha County Jail until such forfeiture has been paid, but for a period of time not to exceed thirty (30) days.

11.052 THEFT OF CABLE SERVICE

A. Definitions.

1. "**Cable Service(s)**" has the meaning given in **Section 26.02 A.3.** of the Code of General Ordinances. "Cable Service" does not include signals received by privately owned antennas that are not connected to a cable system, whether or not the same signals are provided by a cable television company.

2. "**Private Financial Gain**" does not include the gain resulting to any individual from the private use in that individual's dwelling unit of any programming for which the individual has not obtained authorization.

B. Prohibitions. No person may intentionally do any of the following:

1. Obtain or attempt to obtain Cable Service from a company by trick, artifice, deception, use of an illegal device or illegal decoder or other fraudulent means with the intent to deprive that company of any or all lawful compensation for rendering each type of service obtained. The intent required for a violation of this Section may be inferred from the presence on the property and in the actual possession of the defendant of a device not authorized by the cable television company, the major purpose of which is to permit reception of Cable Services without payment. This inference is rebutted if the defendant demonstrates that he or she purchased that device for a legitimate use.

2. Give technical assistance or instruction to any person in obtaining or attempting to obtain any Cable Service without payment of all lawful compensation to the company providing that service. This Section does not apply if the defendant demonstrates that the technical assistance or instruction was given

CODE OF GENERAL ORDINANCES, 2021 - KENOSHA, WISCONSIN

or the installation of the connection, descrambler or receiving device was for a legitimate use.

3. Make or maintain a connection, whether physical, electrical, mechanical, acoustical or by other means, with any cables, wires, components or other devices used for the distribution of Cable Services for the purpose of distributing Cable Service to any other dwelling unit without authority from a cable television company.

4. Make or maintain a connection, whether physical, electrical, mechanical, acoustical or by other means, with any cables, wires, components or other devices used for the distribution of Cable Services for the purpose of obtaining Cable Service without payment of all lawful compensation to the company providing that service. The intent required for a violation of this Section may be inferred from proof that the Cable Service to the defendant's residence or business was connected under a service agreement with the defendant and has been disconnected by the cable television company, and that thereafter, there exists in fact a connection to the cable system at the defendant's residence or business.

5. Make or maintain any modification or alteration to any device installed with the authorization of a cable television company for the purpose of intercepting or receiving any program or other service carried by that company which that person is not authorized by that company to receive. The intent required for a violation of this Section may be inferred from proof that, as a matter of standard procedure, the cable television company places written warning labels on its converters or decoders explaining that tampering with the device is a violation of law and the converter or decoder is found to have been tampered with, altered or modified so as to allow the reception or interception of programming carried by the cable television company without authority to do so. The trier of fact may also infer that a converter or decoder has been altered or modified from proof that the cable television company, as a matter of standard procedure, seals the converters or decoders with a label or mechanical device, that the seal was shown to the customer upon delivery of the decoder, and that the seal has been removed or broken. The inferences under this Section are rebutted if the cable television company cannot demonstrate that the intact seal was shown to the customer.

6. Possess without authority any device or printed circuit board designed to receive from a Cable System any Cable System, whether or not the programming or services are encoded, filtered, scrambled or otherwise made unintelligible, or perform or facilitate the performance of any of the acts under Sections 11.52 A. 1. to 5. with the intent that such device or printed circuit be used to receive that cable television company's services without payment. Intent to violate this Section for direct or indirect commercial advantage or private financial gain may be inferred from proof of the existence on the property and in the actual possession of the defendant of a device if the totality of circumstances, including quantities or volumes, indicates possession for resale.

7. Manufacture, import into this State, distribute, publish, advertise, sell, lease or offer for sale or lease any device, printed circuit board or any plan or kit for a device or for a printed circuit designed to receive the cable television programming or services offered for sale over a Cable System from a Cable System, whether or not the programming or services are encoded, filtered, scrambled or otherwise made unintelligible, with the intent that the device, printed circuit, plan or kit be used for the reception of that company's services without payment. The intent required for a violation of this Section may be inferred from proof that the defendant has sold, leased or offered for sale or lease any device, printed circuit board, plan or kit for a device or for a printed circuit board in violation of this Section and during the course of the transaction for sale or lease, the defendant expressly states or implies to the buyer that the product will enable the buyer to obtain Cable Service without charge.

C. Penalties. The following penalties apply for violations of this Section:

1. **Residential.** Except as provided in **Section C.2.** below, any person convicted of violating any provision of this Section is subject to a forfeiture of not less than One Hundred (\$100.00) Dollars, nor more than Five Hundred (\$500.00) Dollars for each offense, together with the costs of prosecution; and, if in default thereof, shall be committed to the County Jail for a period not to exceed thirty (30) days. Each day such violation continues shall be considered a separate offense.

CODE OF GENERAL ORDINANCES, 2021 - KENOSHA, WISCONSIN

2. Commercial. Any person convicted of violating any provision of this Section for direct or indirect commercial advantage or private financial gain is subject to a forfeiture of not less than One Thousand (\$1,000.00) Dollars, nor more than Two Thousand (\$2,000.00) Dollars; and, if in default thereof, shall be committed to the County Jail for a period not to exceed sixty (60) days. Each day such violation continues shall be considered a separate offense.

3. Second Offense. Any person convicted of violating any provision of this Section for direct or indirect commercial gain as a second or subsequent violation is subject to a forfeiture of not less than Two Thousand (\$2,000.00) Dollars, nor more than Five Thousand (\$5,000.00) Dollars; and, if in default thereof, shall be committed to the County Jail for a period not to exceed ninety (90) days. Each day such violation continues shall be considered a separate offense.

11.053 RETAIL THEFT/FRAUD ON HOTEL OR RESTAURANT KEEPER OR TAXICAB OPERATOR OR GAS STATION

A. Retail Theft. No person shall intentionally alter indicia of price or value of merchandise or request a cash refund or a credit slip for merchandise which he or she has not paid for except where another has paid for said merchandise and authorized said person to request a cash refund or credit slip on their behalf, or take and carry away, transfer, conceal or retain possession of merchandise held for resale by a merchant without his/her consent and with intent to deprive the merchant permanently of possession, or full purchase price of such merchandise.

No person shall aid, abet or conspire with another to intentionally alter indicia of price or value of merchandise or to request a cash refund or a credit slip for merchandise which he or she has not paid for except where another has paid for said merchandise and authorized said person to request a cash refund or credit slip on their behalf, or take and carry away, transfer, conceal or retain possession of merchandise held for resale by a merchant without his/her consent and with intent to deprive the merchant permanently of possession, or full purchase price of such merchandise. The intentional concealment of unpurchased merchandise which continues from one floor to another or beyond the last station for receiving payments in a merchant's store is evidence of intent to deprive the merchant permanently of possession of such merchandise without paying the purchase price thereof. The discovery of unpurchased merchandise concealed upon the person or among the belongings of such person or concealed by a person upon the person or among the belongings of another is evidence of intentional concealment on the part of the person so concealing such goods.

A merchant or merchant's adult employee who has probable cause for believing that a person has violated this Section in his/her presence may detain such person in a reasonable manner for a reasonable length of time to deliver him/her to a peace officer, or to his/her parent or guardian in the case of a minor. The detained person must be promptly informed of the purpose for the detention and be permitted to make phone calls, but he/she shall not be interrogated or searched against his/her will before the arrival of a peace officer who may conduct a lawful interrogation of the accused person. Compliance with the provisions of this paragraph entitles the merchant and the merchant's employee effecting the detention to the same defense in any action as is available to a peace officer making an arrest in the line of duty.

B. Fraud on Hotel or Restaurant Keeper, Taxicab Operator or Gas Station. Whoever does any of the following shall be in violation of this Ordinance:

1. Having obtained any beverage, food, lodging or other service or accommodation at any campground, hotel, motel, boarding or lodging house, or restaurant, intentionally absconds without paying for it.

2. While a guest at any campground, hotel, motel, boarding or lodging house, or restaurant, intentionally defrauds the keeper thereof in any transaction arising out of the relationship as guest.

3. Having obtained any transportation service from a taxicab operator, intentionally absconds without paying for the service.

4. Having obtained gasoline or diesel fuel from a service station, garage, or other place where

CODE OF GENERAL ORDINANCES, 2021 - KENOSHA, WISCONSIN

gasoline or diesel fuel is sold at retail or offered for sale at retail, intentionally absconds without paying for the gasoline or diesel fuel.

C. Prima Facie Evidence.

Under Subsection B. prima facie evidence of an intent to defraud is shown by:

1. The refusal of payment upon presentation when due, and the return unpaid of any bank check or order for the payment of money, given by any guest to any campground, hotel, motel, boarding or lodging house, or restaurant, in payment of any obligation arising out of the relationship as guest. Those facts also constitute prima facie evidence of an intent to abscond without payment.

2. The failure or refusal of any guest at a campground, hotel, motel, boarding or lodging house, or restaurant, to pay, upon written demand, the established charge for any beverage, food, lodging, accommodation or other service actually rendered.

3. The giving of false information on a lodging registration form or the giving of false information or presenting of false or fictitious credentials for the purpose of obtaining any beverage or food, lodging or credit.

4. The drawing, endorsing, issuing or delivering to any campground, hotel, motel, boarding or lodging house, or restaurant, of any check, draft or order for payment of money upon any bank or other depository, in payment of established charges for any beverage, food, lodging, accommodation or other service knowing at the time that there is not sufficient credit with the drawee bank or other depository for payment in full of the instrument drawn. The refusal to pay a taxicab operator the established charge for transportation service provided by the operator constitutes prima facie evidence of an intent to abscond without payment.

5. The failure or refusal to pay the service station, garage, or other place where gasoline or diesel fuel is sold at retail or offered for sale at retail the established charge for gasoline or diesel fuel provided by the service station, garage, or other place constitutes prima facie evidence of an intent to abscond without payment.

D. Election of Remedy.

A judgment may not be entered for a violation of Subsection B. for conduct that was the subject of a judgment including exemplary damages under Section 943.212, Wisconsin Statutes, entitled "Fraud on hotel or restaurant keeper, recreational attraction, taxicab operator or gas station; civil liability." It shall be the affirmative burden of the defendant to demonstrate the existence of any such judgment to the Court.

11.055 NONPAYMENT OF FARES

A. Taxicabs. It shall be unlawful for any person to neglect, refuse or fail to immediately pay, in lawful United States currency, for the transportation he or she has received in any licensed City taxicab upon discharge therefrom, where the nonpayment for said transportation is intended to deprive the owner or operator of the taxicab of the revenue from the service provided. Each and every passenger being transported in a taxicab is personally liable for the cost of his or her individual transportation. The failure of a transported passenger to promptly pay, upon request, for the service provided, shall be prima facie evidence of the intent of said passenger to deprive the taxicab owner or operator of the fee owing for the service provided.

B. City Buses. It shall be unlawful for any person to neglect, refuse or fail to immediately pay, in lawful United States currency, the fare due and owing for the privilege of riding a bus operated by the City Transit Authority upon entering said bus, where the nonpayment of said fare is intended to deprive the City Transit Authority of the revenue from the transportation service provided or to be provided. The failure of a person entering a City bus to pay, upon request to do so, the fare due and owing, shall be prima facie evidence of the intent of said person to deprive the City Transit Authority of the revenue from the

CODE OF GENERAL ORDINANCES, 2021 - KENOSHA, WISCONSIN

transportation service provided or to be provided. All City bus fares shall be due, owing and payable in advance of receiving transportation, upon entering a City bus.

11.056 THEFT, DESTRUCTION, DEFACEMENT AND MUTILATION OF LIFE PRESERVERS

A. Definitions.

1. "Damage" means to render partially unsuitable for its intended purpose, including, but not limited to, detaching a rope from a ring buoy.
2. "Deface" means the disfiguration, marring or soiling, but which does not render the item wholly or partially unsuitable for its intended purpose.
3. "Destroy" means to render wholly unsuitable for its intended purpose.
4. "Kiosk" means a structure holding a life preserver.
5. "Life Preserver" means a lifesaving flotation device, including a ring buoy, and all associated, ancillary attachments, specifically including, but not limited to, a rope.
6. "Take" means to carry away, transfer, conceal or retain possession of any life preserver or kiosk, or to remove a life preserver from the kiosk associated with it.

B. Prohibition. It shall be unlawful for any person to take, destroy, deface or damage a life preserver or kiosk.

C. Exception. The prohibitions of this ordinance do not apply to any act reasonably taken in an attempt to save a human life, or to acts taken by employees of the City in the performance of their duties.

D. Penalty. Any person who violates this Ordinance, upon conviction, shall forfeit not more than one thousand dollars (\$1,000), plus the cost of repair or replacement of material, if necessary, in addition to the costs of prosecution; and, in default of timely payment of such forfeiture, shall be committed to the Kenosha County Jail until such forfeiture has been paid, but for a period of time not to exceed ninety (90) days.

11.06 DANGEROUS WEAPONS

A. Minors and Intoxicated Person. No minor or intoxicated person shall go armed with any gun, pistol, revolver, bow and arrow, when said bow has a 20 pound pull or more, and, iron chains, shuriken (throwing star), or any other dangerous or deadly weapon.

B. Sale Forbidden.

1. No person shall sell, loan or give away any gun, pistol, revolver, bow and arrow, when said bow has a 20 pound pull or more, and, iron chains, shuriken (throwing star), or other dangerous or deadly weapon to any minor or intoxicated person.

2. No person, except a parent or guardian shall sell directly or give away any knife with a blade of more than two (2) inches such as, but without limitation to a pen knife, pocket knife, or jack knife to a child under eleven (11) years of age.

C. Seizure. Police officers or any other public officer shall take from any minor or intoxicated person any gun, pistol, revolver, bow and arrow, when said bow has a 30 pound pull or more, and iron chains, shuriken (throwing star), or any other dangerous or deadly weapon.

D. Carrying Concealed Weapons. No person shall wear under his clothes, or conceal about his person, or display in a threatening manner any dangerous weapon, including, but not by the way of limitations any pistol, revolver, shuriken (throwing star), sling shot, bow and arrow, BB gun, pellet gun, pea shooter, knuckles of brass, lead or metal, or any bowie knife or any knife resembling a bowie knife, or any knife with a switchblade or devices whereby the blade or blades can be opened by a flick of a button,

CODE OF GENERAL ORDINANCES, 2021 - KENOSHA, WISCONSIN

pressure on the handle, other mechanical contrivance, or by gravity or by a thrust or movement, unless such actions are permitted pursuant to §175.60, Wisconsin Statutes.

11.065 CARRYING FIREARM IN PUBLIC BUILDING.

A. Prohibition. It shall be unlawful for any person to go armed with a firearm in any building owned or leased by the State or any political subdivision of the State.

B. Exception. Paragraph A shall not apply to any of the following:

1. Peace officers or armed forces or military personnel who go armed in the line of duty or to any person duly authorized by the chief of police of any city, village or town, the chief of the capitol police, or the sheriff of any county to possess a firearm in any building under Paragraph A. For purposes of this section peace officer does not include a commission warden who is not a state-certified commission warden.

2. A qualified out-of-state law enforcement officer, as defined in Section 941.23 (1) (g), Wis. Stats., to whom section 941.23 (2) (b) 1. to 3. Wis. Stats., applies.

3. A former officer, as defined in Section 941.23 (1)(c) Wis. Stats., to whom Section 941.23 (2) (c) 1. to 7. Wis. Stats., applies.

4. A licensee, as defined in Section 175.60 (1) (d) Wis. Stats., or an out-of-state licensee, as defined in Section 175.60 (1) (g) Wis. Stats.

11.07 ENDURANCE CONTESTS

No person, firm or corporation shall, within the City of Kenosha, advertise, operate, maintain, attend, participate in, promote or aid in advertising, operating, maintaining or promoting any physical endurance contest, exhibition, performance, or show in the nature of a "marathon", "walkathon", "skateathon" or any other physical endurance contest, exhibition, performance or show of a like or similar nature, whether or not an admission is charged or a prize is awarded to any person for participation in such physical endurance contest without first obtaining the permission of the Mayor of said City, it being unlawful to so proceed without said permission. However, said permission shall not authorize any person to participate in an endurance contest as herein described for a period of more than 16 hours in any 24 hours or for a period of more than 6 days in any one calendar month. It shall be a violation of this Ordinance to exceed said limitations.

Permission for said contests shall only be granted where said contest shall be conducted in such place, manner, and circumstances as will not be likely to create a public disturbance or otherwise endanger the public health, safety and welfare or promote a violation of Federal, State or local laws. Further permission shall only be granted to persons, firms or corporations which have a not for profit or gain motive in sponsoring said contest. Permission to hold said contest given to the sponsor or promoter thereof shall be implied permission to others to advertise, operate, maintain, attend, participate, in promote, or aid in advertising, operating, maintaining, or promoting said contest. Permission may also be denied for failure to disclose the full and correct facts forming the basis for said contest.

11.08 NUDITY IN A PUBLIC PLACE

A. Definition. "Nudity" means the showing of the human male or female genitals, or pubic area with less than a fully opaque covering, or the showing of the female breast with less than a fully opaque covering of any part of the nipple.

B. Prohibition. No person shall knowingly or intentionally, in a public place, appear in a state of nudity.

11.085 MINORS PROHIBITED-ADULT USES

It shall be unlawful for any person, party, firm or corporation to knowingly permit any person under the age of eighteen (18) years of age to be present upon the premises of any Adult Use, as defined in Section 12.0 B.7. of the City of Kenosha Zoning Ordinance, except where authorized under HFS 173.05, Wisconsin Administrative Code.

CODE OF GENERAL ORDINANCES, 2021 - KENOSHA, WISCONSIN

11.089 CONVERSION THERAPY

A. Definitions.

1. Conversion therapy means any practice or treatment by any person that seeks to change another individual's sexual orientation or gender identity, including efforts to change behaviors or gender expressions, or to eliminate or reduce sexual or romantic attractions or feelings toward individuals of the same gender, if such person receives monetary compensation in exchange for such practices or treatments. The previous sentence notwithstanding, the term "conversion therapy" does not include any practice or treatment that does not seek to change sexual orientation or gender identity, and that either:

(i) provides assistance to an individual undergoing a gender transition; or
(ii) provides acceptance, support, and understanding of a client or facilitation of a client's coping, social support, and identity exploration and development, including sexual orientation-neutral interventions to prevent or address unlawful conduct or unsafe sexual practices.

2. Gender identity means the gender-related identity, appearance, mannerisms, or other gender-related characteristics of an individual, regardless of the individual's designated sex at birth.

3. Person means any individual, partnership, corporation, cooperative, association, or any other entity.

4. Sexual orientation means a person's sexual identity in relation to the gender to which they are attracted, including the fact of being heterosexual, homosexual, or bisexual.

B. Prohibition.

It is unlawful for any person:

1. to provide conversion therapy to any individual under the age of eighteen years of age if such person receives compensation in exchange for such services; or

2. to knowingly assist or facilitate the provision of conversion therapy to an individual under the age of eighteen years of age if such person receives compensation from any source in connection with providing conversion therapy.

C. Penalty. Any person violating any of the provisions of this section is, upon conviction thereof, subject to a forfeiture of not less than One Hundred Dollars (\$100), nor more than One Thousand Dollars (\$1,000.00), plus the payment of the costs of prosecution, assessments, and surcharges, and in default of the timely payment thereof, either may be committed to the County Jail for a period not to exceed ninety (90) days, or the Court may suspend the person's motor vehicle operating privileges until the forfeiture, assessments, surcharges, and costs are paid, except that the suspension period may not exceed five (5) years. Every day a person is found to have practiced conversion therapy constitutes a separate violation.

11.10 TAG DAYS

A. Designation.

1. The Kenosha Chapter of Hadassah be assigned the twenty-four hour period commencing at noon the third Friday of June for the sale of its emblem, tag or other memento.

2. The following named organizations shall have the respective designated Fridays from 6 A.M. to 10 P.M. for the street sale of its particular emblem, tag, or other memento and shall be permitted to solicit merchants and manufacturers for the four days preceding each such Friday.

Polish Legion of American Veterans - Friday before Mother's Day.

American War Mothers - Friday before Mother's Day.

Local Chapter 171 of the Military Order of the Purple Heart - fourth Friday in September.

CODE OF GENERAL ORDINANCES, 2021 - KENOSHA, WISCONSIN

American Legion Post No. 21 and Post No. 429 and V.F.W. Post No. 1865 and Post No. 2751 - the Friday before Memorial Day.

The Navy Club and War Mothers of World War II - Friday before October 27th.

Lions Club of Kenosha - the first Friday and Saturday in May.

Friday preceding November 11 be assigned to the Veterans of World War I Barracks 2423 for the sale of "Remembrance Tags".

Kiwanis Peanut Day - Third Friday in September.

3. The Knights of Columbus be assigned the last Friday, Saturday and Sunday of April for "Tootsie Roll Tag Days".
4. Friday and Saturday of the third week in December is designated as "Shriners-Salvation Army Bell Ringing Days".
5. The Disabled American Veterans be assigned the second Friday and Saturday of September.
6. The CYO Band of Kenosha be assigned the fourth (4th) Saturday of September.
7. The C.Y.O. Band and Color Guard, Inc. be assigned the first Saturday of May.
8. Animal Rehabilitation Kinship, Inc. (A.R.K.) be assigned the second Saturday of May.
9. Animal Life-Line be assigned the second Saturday of April.
10. Blackwatch be assigned the third Friday and Saturday of May.
11. The Alliance for the Mentally Ill be assigned the Friday of Mental Illness Week.
12. The Kenosha County Humane Society be assigned the second Saturday in June of each year.
13. The Southeastern Wisconsin Building and Construction Trades Council be assigned the Saturday before Father's Day for its "Dollars Against Diabetes" Program.

B. No person or persons except those under the auspices of the above named organizations shall sell or offer for sale any device, trinket, emblem, or thing purporting to commemorate any particular day, and the above named organizations and persons in their behalf shall offer for sale, solicit orders, and sell such emblems, devices, trinkets, or things only during the period above assigned to them.

11.105 AUTOMATIC TELEPHONE DIALING DEVICE PROHIBITED

A. Purpose. Dispatch operations for the City Police and Fire Departments are conducted by Joint Services. It is the intent of this Ordinance that emergency telephone calls be placed with Joint Services, the dispatching agency for the City, in accordance with the rules and regulations governing such service.

B. Definition. Automatic Telephone Dialing Device shall mean any electric or mechanical unit which has the capability of automatically dialing any telephone number programmed into it to deliver either a prerecorded voice message or other signal.

C. Prohibition. It shall be unlawful for any person, firm, corporation or party to install, operate or maintain an "Automatic Telephone Dialing Device" which places emergency telephone calls into any telephone number of the City Police Department, City Fire Department or Kenosha County Safety Building. A violation of this Ordinance shall be deemed to be a public nuisance and the City Attorney, in addition to seeking forfeitures from violators, is directed to bring such Court action as is necessary to abate and enjoin said nuisance.

CODE OF GENERAL ORDINANCES, 2021 - KENOSHA, WISCONSIN

11.11 ABANDONED ICE BOXES AND REFRIGERATORS

It shall be unlawful for any person, firm, or corporation to leave or to permit to remain outside any dwelling, building or other structure, or within any unoccupied or abandoned building, dwelling or other structure under his or its control in a place accessible to children any abandoned, unattended or discarded ice box, refrigerator or other container which has an airtight door or lid, snaplock or other locking device which may not be released from the inside, without first removing said door or lid, snaplock or other locking device from said ice box, refrigerator or container.

11.135 USE OF CIGARETTES AND TOBACCO PRODUCTS PROHIBITED

A. In this Section:

1. **"Cigarette"** means any roll of tobacco wrapped in paper or any substance other than tobacco.

2. **"Law Enforcement Officer"** means any person employed by the state or any political subdivision or the state for the purpose of detecting and preventing crime and enforcing laws or Ordinances and who is authorized to make arrests for violations of the laws or Ordinances he is employed to enforce, and includes a person appointed as a conservation warden by the department under 23.10 (1), Wisconsin Statutes.

3. **"Tobacco products"** means cigars; cheroots, stogies; periques; granulated, plug cut, crimp cut, ready-rubbed, and other smoking tobacco; snuff; snuff flour; cavendish; plug and twist tobacco; fine cut and other chewing tobaccos; shorts; refuse scraps, clippings, cuttings and sweepings of tobacco and other kinds and forms of tobacco prepared in such a manner as to be suitable for chewing or smoking in a pipe or otherwise, or both for chewing and smoking; but does not include cigarettes.

B. Except as provided in Subsection C., no child may do any of the following:

1. Buy or attempt to buy any cigarette or tobacco product.
2. Falsely represent his or her age for the purpose of receiving any cigarette or tobacco product.
3. Possess any cigarette or tobacco product.

C. A child may purchase or possess cigarettes or tobacco products for the sole purpose of resale in the course of employment during his or her working hours if employed by a retailer licensed under §134.65(1), Wisconsin Statutes.

D. A law enforcement officer shall seize any cigarette or tobacco product involved in any violation of **Subsection B.** committed in his or her presence.

11.14 PROHIBITING UNNECESSARY NOISES

A. **Declaration.** It is found and declared that:

1. That making and creation of loud, unnecessary or unusual noises within the limits of the City of Kenosha is a condition which has existed for some time and the extent and volume of such noises is increasing;

2. The making, creation or maintenance of such loud, unnecessary, unnatural or unusual noises which are prolonged, unusual and unnatural in their time, place and use affect and are a detriment to public health, comfort, convenience, welfare and prosperity of the residents of the City of Kenosha; and,

3. The necessity in the public interest for the provisions and prohibitions hereinafter contained and enacted is declared as a matter of legislative determination and public policy, and it is further declared that the provisions and prohibitions hereinafter contained and enacted are in pursuance of and for the purpose of securing and promoting the public health, comfort, convenience, safety, welfare and prosperity and peace and quiet of the City of Kenosha and its inhabitants.

CODE OF GENERAL ORDINANCES, 2021 - KENOSHA, WISCONSIN

B. Generally. It shall be unlawful for any person to make or permit to be made, to continue or permit to be continued, or to cause to be made or continued any loud, unnecessary or unusual noise or any noise which either annoys, disturbs, injures or endangers the comfort, repose health, peace or safety of others within the limits of the City.

C. Specifically. The following acts, among others, are declared to be loud, disturbing and unnecessary noises in violation of this Ordinance (11.14), but said enumeration shall not be deemed to be exclusive, namely:

1. Automobiles, Motorcycles, etc. The operation of automobiles, trucks, motorcycles or other motor vehicles in such manner as to make the wheels or tires thereof squeal and screech when such operation is not necessary for the purpose of protecting life and property or avoiding an accident; the operation of the motor of an automobile, truck, motorcycle or other motor vehicle at an unnecessarily high rate of speed while the vehicle itself is not in motion; the discharge into the open air of the exhaust of any automobile, motorcycle, truck or other motor vehicle except through a muffler or other device which will effectively prevent loud or explosive noises therefrom.

2. No railroad engineer, conductor or other railroad employee, hereinafter referred to as "Operator of the Locomotive", shall blow, sound or cause to be blown or sounded, any airhorn, whistle or other warning device other than a bell, on any locomotive within any portion of the City East of Green Bay Road [Wisconsin State Highway "31"], except when, in the judgment of the Operator of the Locomotive, it is necessary to do so to prevent damage to property or injury to persons as a result of, because of a dangerous condition or circumstance existing at that place and time.

11.141 REGULATION OF ALL-TERRAIN VEHICLES, SNOWMOBILES AND DIRT BIKES ON PUBLIC PROPERTY

A. Definitions. The following phrases and terms used in this Ordinance shall have the meaning provided herein:

1. "All-Terrain Vehicle" means an engine driven device which is designed to travel on three (3) or more low pressure tires and designed especially to operate off public roads.

2. "Dirt Bike" means a small, usually lightweight motorcycle or motor bicycle designed especially to operate off public roads.

3. "Operate" means to exercise physical control over the speed or direction of, or to physically manipulate or activate any of the controls of an all-terrain vehicle, snowmobile or dirt bike necessary to put it in motion.

4. "Operation" means the exercise of physical control or the physical manipulation or activation of any of the controls of an all-terrain vehicle, snowmobile or dirt bike necessary to put it in motion.

5. "Operator" means a person who operates, who is responsible for the operation of, or who is supervising the operation of an all-terrain vehicle, snowmobile or dirt bike.

6. "Public Property" means any property owned or controlled by the City of Kenosha, or its subunits, excluding the portion of street right-of-ways designated for motor vehicle traffic, excluding park land.

7. "Snowmobile" means an engine driven vehicle that is manufactured solely for snowmobiling, that has an endless belt tread and sled-type runners or skis, to be used in contact with snow.

Other words and phrases defined in Section 340.01, Wisconsin Statutes, are incorporated herein by reference.

B. Prohibition. No operator shall operate or cause the operation of an all-terrain vehicle, snowmobile or dirt bike upon public property without the written permission of the Director of Public Works or designee,

CODE OF GENERAL ORDINANCES, 2021 - KENOSHA, WISCONSIN

except for City employees and agents of City performing work or services for or on behalf of the City of Kenosha.

11.143 REGULATION OF THE SALE, POSSESSION, TRANSFER AND USE OF TOXIC GLUES

A. Definition. Toxic glue shall mean any glue, adhesive cement, mucilage, plastic cement or any similar substance containing one or more of the following volatile substances:

Acetone, benzene, butyl alcohol, cyclohexanone, ethyl acetate, ethyl alcohol, ethylene dichloride hexane, isopropyl alcohol, methyl alcohol, methyl cellosolve, acetate methyl, ethyl ketone, isobutyl ketone, pentachlorophenol, petroleum ether, trichlorethylene, tricresyl phosphat, toluene, toluol, or any other chemical capable of producing intoxication when inhaled.

B. Inhalation of Vapors or Fumes from Toxic Glues Prohibited. No person shall inhale or otherwise introduce into his respiratory tract any toxic glue or any vapors or fumes which may be released from any toxic glue with the intent of becoming intoxicated, elated, excited, stupefied, irrational, paralyzed, or of changing, distorting or disturbing his eyesight, thinking process, judgment, balance or muscular coordination.

C. Limitations on Sales, Transfer, and Possession of Toxic Glue. No person shall, for the purpose of violating or aiding another to violate any provision of this Section, possess, buy, sell, transfer possession or receive possession of any toxic glue.

No person shall sell or transfer possession of any toxic glue to any person under 18 years of age; provided, however, that one tube or container of toxic glue may be sold or transferred to a child under 18 years of age immediately in conjunction with the sale or transfer of a model kit, if the kit requires approximately such quantity of the glue for assembly of the model, and provided, further, that nothing herein contained shall be applicable to the transfer of a tube or other container of such glue from a parent to his child or from a legal guardian to his ward.

D. Penalties. Any person, firm or corporation violating any part of this Ordinance shall upon conviction thereof be punished by a fine of not less than \$10 or more than \$100, together with the costs and disbursements of the prosecution, and in default thereof shall be imprisoned in the County Jail for a period of time not to exceed thirty (30) days. Each day that each violation continues shall be considered a separate offense.

E. Validity. Should any section, paragraph, sentence, clause or phrase of this Ordinance be declared unconstitutional or invalid or be repealed, it shall not affect the validity of the Ordinance as a whole or any part thereof other than the part so declared to be invalid or repealed.

All Ordinances, or parts of Ordinances, contravening the provisions of this Ordinance are hereby repealed.

11.144 REGULATION OF E-CIGARETTES

A. Purpose

1. The purpose of this section is to protect the public health, safety, and welfare of the property and persons in the City by prohibiting persons under eighteen years of age from possessing e-cigarette products, and prohibiting the sale of e-cigarette products to persons under eighteen years of age.

2. Persons under eighteen years of age or prohibited by law from purchasing or possessing cigarettes and other tobacco products, and retailers are prohibited from selling them to minors. There are new tobacco- less products, however, commonly referred to as "electronic cigarettes," "e-cigarettes," "e-cigars," "e-cigarillos," "e-pipes," "e-hookahs," or "electronic nicotine delivery systems," which allow the user to simulate cigarette smoking. These products may be purchased by minors and are being marketed without age restrictions or health warnings and come in different flavors that appeal to young people.

3. E-cigarettes, and similar devices, are relatively new nicotine delivery systems. While devices vary in

CODE OF GENERAL ORDINANCES, 2021 - KENOSHA, WISCONSIN

their appearance and specific methods of operation, they have a few basic elements in common. A solution (which frequently includes nicotine, and can contain lobelia, and/or flavorings, in addition to other additives) is heated with the heating element (which is usually battery-powered) until it is vaporized. The resultant vapor passes into a mouthpiece and is inhaled in a manner similar to cigarette smoking. Often, glycerol or propylene glycol is added to the solution to give the appearance of smoke when the solution is vaporized. The concentration of nicotine contained in the solution can be customized by the retailer to the buyer's specifications.

4. The production and distribution of e-cigarettes is not currently regulated by federal or state authorities, and U.S. Food and Drug Administration has not completed testing of these products. Initial studies by the FDA have determined that e-cigarettes can increase nicotine addiction among young people and that they contain chemical ingredients known to be harmful, which may expose users and the public to potential health risks.

5. The use of e-cigarettes and similar devices has increased significantly in recent years.

6. Existing studies on electronic smoking devices' vapor emissions and cartridge contents found a number of dangerous substances irrespective of the nicotine, including:

- a. Chemicals known to cause cancer such as formaldehyde, acetaldehyde, lead, nickel, and chromium;
- b. PM 2.5, acrolein, tin, toluene, and aluminum, which are associated with a range of negative health effects such as skin, eye, and respiratory irritation, neurological effects, damaged reproductive systems, and premature death from heart attacks and strokes.

7. Some electronic smoking devices use cartridges to contain the solution during vaporization. While these cartridges may initially be sold without nicotine, they may be refilled by the user with a liquid nicotine solution, creating the potential for exposure to dangerous concentrations of nicotine.

8. Clinical studies about the safety and efficacy of these products have not been submitted to the FDA for the over 400 brands of electronic smoking devices that are on the market, and for this reason, consumers have no way of knowing whether electronic smoking devices are safe, what types of potentially harmful chemicals the products contain, and what dose of nicotine the products deliver.

9. Electronic smoking devices often mimic conventional tobacco products in shape, size, and color, with the user exhaling a smoke-like vapor similar in appearance to the exhaled smoke from cigarettes and other conventional tobacco products.

10. Is the intent of the Common Council, and in enacting the ordinance codified in this section, to provide the public's health, safety, and welfare by reducing the potential for children to associate with use of electronic smoking devices with the normative or healthy lifestyle and by prohibiting the sale or distribution of electronic smoking devices to minors.

11. The Common Council determines that prohibiting the sale, giving, or furnishing of e-cigarettes to minors and prohibiting the purchase, possession, or use of e-cigarettes by minors is in the City's best interest and will promote public health, safety, and welfare.

B. Definition. "Electronic Smoking Device" has the same meaning as the same term in Paragraph 4.05 B.1. of the Code of General Ordinances.

C. Sales of Electronic Smoking Devices to Persons Under the Age of 18. No person may sell or offer for sale any Electronic Smoking Device to a person under 18 years of age.

D. Possession of Electronic Smoking Devices by Persons Under the Age of 18. No person under the age of 18 years of age may possess an Electronic Smoking Device.

11.145 DRUG PARAPHERNALIA

A. Definitions. The definitions set forth in §961.571, Wis. Stats., are hereby adopted by reference and made a part hereof.

CODE OF GENERAL ORDINANCES, 2021 - KENOSHA, WISCONSIN

B. Determination. The factors set forth in §961.572, Wis. Stats., are hereby adopted by reference and made a part hereof as factors a court or other authority shall consider in making the determinations referred to in §961.572, Wis. Stats.

C. Possession of Drug Paraphernalia. No person may use, or possess with the primary intent to use, drug paraphernalia to plant, propagate, cultivate, grow, harvest, manufacture, compound, convert, produce, process, prepare, test analyze, pack, repack, store, contain, conceal, inject, ingest, inhale or otherwise introduce into the human body a controlled substance in violation of this subsection.

D. Manufacture or Delivery of Drug Paraphernalia. No person may deliver, possess with intent to deliver or manufacture with intent to deliver drug paraphernalia, knowing that it will be primarily used to plant, propagate, cultivate, grow, harvest, manufacture, compound, convert, produce, process, prepare, test, analyze, pack, repack, store, contain, conceal, inject, ingest, inhale or otherwise introduce into the human body a controlled substance in violation of this subsection.

E. Penalty.

1. Any person, firm, party or corporation convicted for a violation of the above Ordinance shall forfeit from \$10.00 to \$750.00 for each offense, plus the cost of prosecution, and in default thereof shall be imprisoned to the County Jail or House of Correction for a period not to exceed ninety (90) days.

2. Any drug paraphernalia used in violation of this section shall be forfeited and seized by the City. Any drug paraphernalia forfeited and seized shall be destroyed in accordance with the standard operating procedures established by the Kenosha Police Department.

11.146 POSSESSION OF MARIJUANA

A. Intent. It is the intent of the Common Council of the City of Kenosha to effectively control and regulate the possession and use of small amounts of marijuana (1 ounce or 28 grams or less of marijuana). It is intended that this Ordinance will promote, encourage and expedite law enforcement and prosecution for such violations. Possession of amounts of marijuana exceeding 1 ounce or 28 grams and/or subsequent violations for such offenses will continue to be referred to the District Attorney's office for State criminal prosecution.

B. It shall be unlawful for any person to use or carry, or for any person, firm, party or corporation to possess marijuana as that substance is defined in Section 961.01(14), Wisconsin Statutes (2006), except as otherwise authorized by Chapter 961 of the Wisconsin Statutes (2006).

Penalty. Any person, firm, party or corporation convicted for a violation of the above Ordinance shall forfeit from \$10.00 to \$750.00 for each offense, plus the costs of prosecution, and in default thereof shall be committed to the County Jail for a period not to exceed ninety (90) days.

11.147 SYNTHETIC MARIJUANA - SYNTHETIC CANNABINOID

A. Possession, Sale and Use Prohibited. No person shall possess, purchase, display for sale, attempt to sell, sell, give back or use any chemical derivative of marijuana, or any other substance, designed to mimic the physical, psychological, intoxicating, narcotic or other effects of marijuana. Common street or trade names of said substances which are prohibited include, but are not limited to, "Spice", "K-2", "Genie", "Yucatan Fire", "Blaze", "Red Dawn X", "Zohia", "Dancing Monkey", "Spike Diamond", "Route 69", "Smoke XXXX" and "fake" or "new" marijuana, or by any other name, label or description:

1. (6aR, 10aR)-9-(hydroxymethyl)-6, 6dimethyl-3-(2methyloctan-2-yl)-6a,7,10 10a-tetrahydrobenzo[c]chromen-1-ol - some trade or other names: HU-210;

2. 1-Pentyl-3-(1-naphthoyl) indole - some trade or other names: JWH-018\spice;

CODE OF GENERAL ORDINANCES, 2021 - KENOSHA, WISCONSIN

3. 1-Butyl-3-(1-naphthoyl) indole - some trade or other names: JWH-073;
4. 1-(3(trifluoromethylphenyl)) piperazine - some trade or other names: TFMPP;
5. 2-(3-hydroxycyclohexyl)-5-(2-methyloctan-2-yl)phenol - some trade or other names: CP 47, 497;
6. 1-(2-(4-(morpholinyl)ethyl))-3-(1-naphthoyl) indole - some trade or other names: JWH-200;
7. 1-hexyl-3-(1-naphthoyl)indole - some trade or other names: JWH-019;
8. 1-pentyl-3-(2-methoxyphenylacetyl)indole - some trade or other names: JWH-250;
9. 1-pentyl-3-(4-chloro-1-naphthoyl)indole - some trade or other names: JWH-398;
10. (2-methyl-1-propyl-1H-indol-3-yl)-1-naphthalenyl-methanone - or some trade or other names: JWH-015;
11. Dexanabinol, (6aS,10aS)-9-(hydroxymethyl)-6, 6-dimethyl-3- (2-methyloctan-2-yl) -6a, 7, 10, 10a-tetrahydrobenzo[c]chromen-1-ol - or some trade or other names: HU-211;
12. or any similar structural analogs.

B. Medical and Dental Use Allowed. Acts prohibited under sub A. shall not be unlawful if done by or under the direction or prescription of a licensed physician, dentist, or other health professional authorized to direct or prescribe such acts, provided use is permitted under state and federal laws.

C. Penalties. Persons violating this section shall forfeit not less than \$100.00 nor more than \$750.00 for each offense, plus the cost of prosecution, and upon default shall be imprisoned in the county jail or house of correction for a period not to exceed ninety (90) days.

11.148 SPRAY PAINTING

A. Definitions.

1. Spray Paint(ing) shall mean the spraying of paint, lacquer, varnish, shellac, solvent, or similar substance, accomplished through means of an aerosol container, compressor or electrical device.

2. Commercial Spray Painting shall mean spray painting undertaken or any gain or profit, whether or not money is paid as consideration therefor.

3. Motor Vehicle shall include mobile home, moped, motor bicycle, motorbus, motorcycle, motor driven cycle, motor home, motor truck and motor vehicle, as defined in Chapter 340, Wisconsin Statutes.

B. Prohibition.

1. Spray Painting. No person shall engage in spray painting under circumstances wherein spray painting results in hazardous excess emissions which may be injurious to health or wherein excess spray particles could damage the property of another.

2. Commercial Spray Painting Insurance. No person shall engage in commercial spray painting who is not covered by a liability insurance policy which is in full force and effect and issued by an insurance company licensed to do business in the State of Wisconsin covering death, personal injury and property damage in an amount of not less than Three Hundred Thousand (\$300,000) Dollars per occurrence.

3. Painting - Residentially Zoned Property. No person shall, upon any residentially zoned property, spray paint a motor vehicle, snowmobile, boat or trailer, unless said motor vehicle, snowmobile, boat or trailer is licensed and registered in the name of the person or persons who reside on the property.

CODE OF GENERAL ORDINANCES, 2021 - KENOSHA, WISCONSIN

C. Separate Offense. Each day or violation of any provision of this Ordinance shall be deemed a separate offense.

11.149 RUMMAGE/GARAGE SALES

A. Definitions.

1. **Rummage/Garage Sale** shall mean any sale of personal property conducted on any residentially zoned property, as defined by the Kenosha Zoning Ordinance, within the City, irrespective of what the sale is designated as by the seller.

2. **Personal Property** shall mean and include any property, other than real estate, which is acquired in the course of living in or maintaining a dwelling unit.

B. Prohibition.

1. It shall be unlawful for any person or party to sell other than personal property at a Rummage/Garage Sale.

2. It shall be unlawful for any person or party to hold or permit to be held a Rummage/Garage Sale on more than six (6) calendar days, whether or not consecutive, within any calendar year.

3. It shall be unlawful for any person or party to hold or permit to be held a Rummage/Garage Sale during the hours of 9:00 P.M. to 8:00 A.M. on any day.

C. Enforcement. The City Departments of City Inspections and Police shall have the authority to enforce the provisions of this section.

11.15 PARKING PROHIBITED IN LOTS USED FOR RESIDENTIAL PURPOSES

A. Definitions.

1. **"Back Yard"** shall mean that area of the yard located directly behind the principal physical structure which extends up to the rear lot line.

2. **"Driveway Apron"** shall mean that surface paved or graveled located on private property which extends from the street right-of-way to the accessory building or its termination, whose intended use is egressing and ingressing the property with motor driven vehicles.

B. Parking Prohibited. Off-street parking of motor vehicles, watercraft or recreational vehicles on lots used for residential purposes is prohibited except in the back yard or driveway apron of such lot. This prohibition shall not apply for periods of a declared snow emergency.

11.16 HIRING OF PROFESSIONAL STRIKEBREAKERS PROHIBITED

A. Title and Purpose. It is hereby declared that the employment of those individuals commonly known as professional strikebreakers within the community during the course of a labor dispute substantially contributes to prolonged industrial strife and to the danger of violent activity endangering the lives and property of the residents of this City, thereby necessitating the prohibitions established by this Section, which shall be deemed an exercise of the police powers for the protection of the peace, dignity, health and welfare of the people of the City of Kenosha.

B. Definitions. When used in these sections:

1. The term **"person"** shall include one or more individuals, partnerships, corporations, associations or firms and shall include any officer, employee or agent thereof.

2. The term **"labor dispute"** shall mean a controversy between employer and his employees which results in a strike or a lockout.

a. The term **"professional strikebreaker"** shall mean any person who customarily and repeatedly secures or seeks to secure gainful occupation by offering to take the place or replacing any employee absent from his position of

CODE OF GENERAL ORDINANCES, 2021 - KENOSHA, WISCONSIN

employment because of a labor dispute.

C. General Provisions.

1. No person shall recruit, procure, supply, or refer for purposes of employment any professional strikebreaker in place of any employee involved in a labor dispute in which such person is not directly involved.

2. No person involved in a labor dispute shall either directly or indirectly:

a. Employ in the place of any employee involved in such labor dispute any professional strikebreaker during the course of the labor dispute.

b. Contract or arrange with any other person to recruit, procure, supply, or refer for the purposes of employment any professional strikebreaker in place of employees involved in such labor dispute.

3. No professional strikebreaker shall take or offer to take the place of any employee involved in a labor dispute during the course of such labor dispute.

D. Exceptions. Nothing in this Section other than the employment of any professional strikebreaker shall be construed to prevent or prohibit a person involved in a labor dispute from conducting business operations during the course of such labor dispute.

E. Severability. Should any section, paragraph, sentence, clause or phrase of this Section be declared unconstitutional or invalid, or be repealed, it shall not effect the validity of this Ordinance as a whole or any part thereof other than the part so declared to be invalid or repealed.

F. Penalties. Any person who shall violate the provisions of this Section shall upon conviction thereof be subject to a fine of not less than Fifty (\$50.00) Dollars nor more than Five Hundred (\$500.00) Dollars, or by imprisonment in the County Jail for not more than sixty (60) days in default of payment.

11.17 PENALTIES

A. Except as hereinafter provided, anyone violating any of the provisions of this Chapter, upon conviction thereof, shall be subject to a forfeiture not to exceed One Thousand (\$1,000.00) Dollars, plus the payment of the costs of prosecution, assessments and surcharges, and in default of the timely payment thereof, shall either be committed to the County Jail for a period not to exceed ninety (90) days, or the Court may suspend the Defendant's motor vehicle operating privileges until the forfeiture, assessment, surcharges and costs are paid, except that the suspension period may not exceed five (5) years.

B. Anyone violating any of the provisions of §§11.02 Q. or 11.02 R. of this Chapter shall, upon conviction thereof, be subject to a forfeiture of not less than One Hundred (\$100) Dollars, nor more than One Thousand (\$1,000.00) Dollars, plus the payment of the costs of prosecution, assessments, and surcharges, and in default of the timely payment thereof, shall either be committed to the County Jail for a period not to exceed ninety (90) days, or the Court may suspend the Defendant's motor vehicle operating privileges until the forfeiture, assessments, surcharges, and costs are paid, except that the suspension period may not exceed five (5) years.

C. Except as hereinafter provided, anyone violating §11.13 of this Chapter, upon conviction thereof, shall be subject to the following:

1. In this paragraph violation means a violation of §11.13, Code of General Ordinances.

2. A person who commits a violation is subject to a forfeiture of:

a. Not more than Five Hundred (\$500.00) Dollars if the person has not committed a previous violation within twelve (12) months of the violation; or,

b. Not less than Two Hundred (\$200.00) Dollars nor more than Five Hundred (\$500.00) Dollars if the person has committed a previous violation within twelve (12) months of the violation.

CODE OF GENERAL ORDINANCES, 2021 - KENOSHA, WISCONSIN

3. A court shall suspend any license or permit issued under §§134.65, 139.34 or 139.79, Wisconsin Statutes, to a person for:

a. Not more than three (3) days, if the Court finds that the person committed a violation within twelve (12) months after committing one previous violation;

b. Not less than three (3) days nor more than ten (10) days, if the Court finds that the person committed a violation within twelve (12) months after committing two other violations; or,

c. Not less than fifteen (15) days nor more than thirty (30) days, if the Court finds that said person committed the violation within twelve (12) months after committing three or more other violations.

4. The Court shall promptly mail notice of suspension under Subsection **C.3.** to the Department of Revenue and to the clerk of each municipality which has issued a license or permit to the person.

5. Whoever violates Section 11.13 B.2.a. or **b.**, upon conviction thereof, shall forfeit not more than Twenty-five (\$25) Dollars.

D. Anyone violating Section 11.135 B.1., 2., or **3.**, upon conviction thereof, shall forfeit not more than Twenty-five (\$25) Dollars.

E. A person who commits a violation of Section **11.034**, upon conviction, is subject to a forfeiture of not less than Five Hundred (\$500.00) Dollars and not more than Five Thousand (\$5,000.00) Dollars, plus the costs of prosecution.

CODE OF GENERAL ORDINANCES, 2021 - KENOSHA, WISCONSIN

CHAPTER XII AMUSEMENTS

12.001 AMUSEMENT DEVICE LICENSE

A. Definition(s).

1. "**Amusement Device**" means any machine, game, or similar device whether or not operated by coins, slugs, tokens, or similar items which permits a person or operator to use the device as a game or contest of skill or amusement, whether or not the device registers a score, which may cause a person or operator of the same to secure some amusement, enjoyment, or entertainment, and which is not a gambling machine as defined by Wis. Stats. §945.01(3). The term shall include, but not be limited to because of enumeration, jukebox, electronic, video, or mechanical game machines, pinball machines, shuffleboard, dart boards, and pool or billiard tables.

B. License Required.

1. **Amusement Device License.** No person, corporation or other legal entity which has possessory control of any commercial premises, shall permit, keep, or maintain an amusement device(s) as herein defined without first obtaining an "amusement device" license to be issued by the City Clerk. The annual fee for such license shall be Sixty (\$60.00) Dollars for the first device and Sixty (\$60.00) Dollars for each additional device located on the premises. Any location where there are ten (10) or more amusement devices on the premises shall also be subject to the licensing requirements of §12.01 of the Code of General Ordinances. In the event that the Licensee shall add additional devices during the licensing period it shall be the licensee's responsibility to advise the City Clerk of any increase in the number of such devices and pay the appropriate fee prior to installing the additional device. The Clerk shall issue an updated license in the event additional devices are added during the license term. All licenses shall expire on the Thirtieth (30th) day of June each year and there shall be no pro-ratio or adjustment of a license fee for less than one (1) year. The license shall not be transferable. Upon written notice to the City Clerk by the Licensee, devices added for the purpose of conducting a state or city tournament shall be exempt from this provision. Notice shall be filed with the City Clerk seven (7) days prior to the start of the tournament. Upon completion of the tournament, the devices shall be removed from the premises or be subject to licensing.

2. **Applications** for an amusement device license shall be made to the City Clerk on forms furnished by the City Clerk accompanied by the required fee.

3. **Review.** Licenses will be reviewed by the City Clerk. If the City Clerk is satisfied that the applicant should be entitled to a license the Clerk shall issue a license. However, any applicant desiring to appeal the City Clerk's or designee's ruling to the Common Council may do so by filing a written Notice of Appeal with the City Clerk. Appeals may be acted upon by the Council following the review and recommendation made by the Committee on Licenses/Permits.

4. License Display, Posted.

a. **Frame.** An amusement device license shall be enclosed in a frame having a transparent front which allows the license to be clearly read.

b. **Display.** An amusement device license shall be conspicuously displayed for public inspection at all times.

5. Exemptions From License Fee.

The following are not required to pay the required license fee:

a. A charitable organization registered and in good standing with the State of Wisconsin Department of Financial Institutions upon submission of a copy of their proof of registration.

b. An organization that is described in Section 501(c)(3) of the internal revenue code upon submission of a copy of their 501(c) tax exemption letter issued by the Internal Revenue Service.

CODE OF GENERAL ORDINANCES, 2021 - KENOSHA, WISCONSIN

C. Revocation of License.

The violation of this section and any regulations set forth herein for the violation by the licensee of any city, county, state or federal laws, rules and regulations, or permitting others to violate such ordinances, laws, rules and regulations on the premises shall be sufficient grounds for revocation of license.

D. Penalties.

In addition to the revocation of said license any person violating the provisions of this section shall, upon conviction thereof, pay a forfeiture of not less than One Hundred (\$100.00) Dollars not more than Two Hundred (\$200.00) Dollars for the first offense and not less than Two Hundred (200.00) Dollars or more than Five Hundred (\$500.00) Dollars for the second conviction within one (1) year, and penalties and costs of prosecution. If such forfeiture and costs are not paid as directed by the Court, the Court may direct imprisonment in the Kenosha County Jail for a period of not more than ninety (90) days.

12.01 AMUSEMENT AND RECREATION ENTERPRISE LICENSE

A. Definitions.

1. Amusement And Recreation Enterprise shall mean a place, whether indoor or outdoor, where amusement or recreational activities are furnished upon payment of a charge or membership fee, to include, but not limited to, Bowling Alleys, Pool Halls, Skating Rinks, Shooting Galleries and Public Dances. Amusement and Recreation Enterprise shall not include any such facility operated by a unit of government or agency thereof, or by any accredited school, school system or college.

2. Amusement Or Recreational Activities shall include games of chance or skill, children's rides, pinball machines, mechanical games, video games and other amusement devices where there are fifteen (15) or a combination of fifteen (15) or more thereof on the premises, irrespective of whether or not coin or token operated. Amusement or recreational activities shall also include eleven (11) of any such devices or combination thereof when combined with four (4) pool tables, or twelve (12) of any such devices or combination thereof when combined with three (3) pool tables, or thirteen (13) of such devices or any combination thereof combined with two (2) pool tables or fourteen (14) of any such devices or any combination thereof, when combined with one (1) pool table.

3. Good Moral Character shall mean to be law abiding, to conduct regulated activity in accordance with licensing and permitting regulations, to honor lawful contractual obligations, and to be honest and trustworthy.

4. Pool Table shall mean any table or structure used for the playing of pool, bumper pool or billiards, irrespective of table size.

5. Pool Hall shall mean any building, structure, room, space or area having five (5) or more pool tables.

6. Skating Rink shall mean any building, structure, room, space, or area in which skating is featured.

7. Skating shall include roller skating, roller blading, skateboarding, ice skating or any similar activity.

8. Public Dance shall mean recreational dancing and shall exclude dance lessons through professional instruction or dances held on premises holding a Cabaret License under Chapter 10 of the Code of General Ordinances.

B. Licenses Required.

1. No person, party, firm or corporation shall operate or maintain an Amusement and Recreation Enterprise without first obtaining from the Common Council a license so to do. If the applicant be a firm or corporation, it shall appoint an agent, named in the application, who shall be subject to approval by the Common Council and who shall have all the qualifications of a person applying for a license. The fee for such a license, shall be One Hundred Fifty (\$150.00) Dollars. For the license term commencing June 1, 2003, the fee for such a license shall be Two Hundred (\$200.00) Dollars. The license period shall be June

CODE OF GENERAL ORDINANCES, 2021 - KENOSHA, WISCONSIN

1st through the following May 31st. Licensees and agents must be persons, eighteen (18) years of age or older, and of good moral character.

a. Application. Application for such a license shall be made to the City Clerk in writing, accompanied by the required fee. Such application shall be fully completed on City forms, and shall define all areas and rooms to be licensed.

b. Inspection and Recommendation. Upon receipt of any application, the City Clerk shall send copies thereof to the Department of City Inspections, County Health Department, and Fire Department who, within ten (10) days of receiving such copies, shall make a report, in writing, as to whether the premises meet the requirements in Subsection "C". with any other pertinent information. The City Clerk shall also send a copy of the application to the Police Department, who shall report, in writing, to the City Attorney, as to any police record of applicant which may reflect upon good moral character. The City Attorney, or designee thereof, shall examine said record and make a recommendation based thereon as to whether or not the license should be granted or agent status approved. A recommendation for denial shall consider only such portions of the record as are materially related to the licensed activity. Such reports shall be delivered to the City Clerk who, in turn, shall deliver them, with the application, to the Committee on Licenses/Permits. Such Committee shall recommend to the Common Council either the granting or denial of the application.

2. Supervisor License. No person, other than the licensee, or an agent of a corporate licensee, shall assume or be permitted to assume the charge of supervision of a licensed premises without a license from the Common Council so to do. The fee for such a license shall be Fifteen (\$15) Dollars. For the license term commencing June 1, 2003, the fee for such a license shall be Twenty-five (\$25.00) Dollars. The license period shall be June 1st through the following May 31st. No person shall be so licensed unless he or she be a person eighteen (18) years of age or older and of good moral character.

a. Application. Application for a supervisor license shall be made to the City Clerk in writing accompanied by the required fee. Such application shall be fully completed on City forms.

b. Inspection and Recommendation of Licenses. The procedure set forth for the review of the police record of a Licensee or agent in Subsection B.1.b. of this Ordinance shall be applicable.

3. Revocation, NonRenewal and Suspension of Licenses. The Common Council, for just cause, may suspend, revoke, or not renew any license or agent status herein provided, upon serving upon such party written notice of the charges forming a basis for the proposed penalty, in the same manner as that for the service of a Summons in a civil action. Service upon an appointed agent shall be deemed service upon a corporation. Said notice shall provide for a hearing upon a written request therefor being filed with the City Clerk within ten (10) days of service. Absent a timely request for a hearing, the City Clerk shall administratively impose the penalty set forth in said notice.

a. Criteria For License Revocation, NonRenewal Or Suspension. Any Licensee who, within a 730 day period, equals or exceeds a total of one hundred (100) demerit points for the below described conduct committed by Licensee, or employee or agent thereof, whether or not charged and/or convicted, shall have their License subject to revocation, nonrenewal, or suspension, within the discretion of the Common Council.

(1) Twenty-five (25) Demerit Points (except as provided in Subsection a.(2):

(a) Violation of Chapter 125, Wisconsin Statutes.

(b) Violation of Chapters X, XI, XII, of the Code of General Ordinances.

(c) Violation of any City or County Gambling Ordinances or knowingly permitting any person to commit such violation.

(d) File an untrue, incorrect and/or incomplete application in violation of §1.22 A. of the Code of General Ordinances.

CODE OF GENERAL ORDINANCES, 2021 - KENOSHA, WISCONSIN

(2) Thirty-five (35) Demerit Points:

(a) Violation of a State or Federal misdemeanor criminal gambling law or knowingly permitting any such violation.

(b) Violation of any State misdemeanor criminal law or City Ordinance prohibiting the use of marijuana or possession thereof without intent to sell or knowingly permitting any person to commit such violation.

(3) Fifty (50) Demerit Points:

(a) Obstruction of any law enforcement officer or knowingly permitting any person to engage in such conduct.

(b) Failing to appear before the Committee or Common Council when ordered to do so by either such body.

(c) Violation of a State or Federal misdemeanor or knowingly permitting any such violation.

(d) Violation of an Order of the Common Council.

(4) One Hundred (100) Demerit Points:

(a) Violation of any State or Federal criminal law prohibiting the sale, trafficking in, or possessing with intent to sell marijuana or any controlled substance, or knowingly permitting any person to commit such violation.

(b) A conviction for a violation of State or Federal criminal law which is a felony, if the circumstances of the charge substantially relate to the circumstances of the licensed activity.

(c) Violation of any State misdemeanor criminal law or City Ordinance prohibiting the use of marijuana or possession thereof with or without intent to sell or knowingly permitting any person to commit such violation.

(5) Discretionary Demerit Points. Nonscheduled offenses shall be the subject of such number of demerit points as designated by the Common Council, within its discretion.

b. Discretion Upon Review. The Common Council is not mandated to revoke, not renew or suspend a License which is subject to revocation, nonrenewal or suspension based upon the criteria in Subsection A. therefor, but may take such action as the circumstances warrant with due consideration for mitigating factors.

A dismissal of a criminal charge or civil forfeiture case which is also the subject of demerit points, shall not, as a matter of law, nullify said charge for the purpose of review herein due to the differing burdens of proof and procedural requirements.

c. Disciplinary, NonRenewal, Suspension and Revocation Hearings. Disciplinary hearings, including nonrenewal, suspension and revocation hearings, shall be held before the Committee on Licenses/Permits, which shall submit a report to the Common Council, including Findings of Fact, Conclusions of Law and a recommendation as to what action, if any, the Common Council should take with respect to the License. The Committee on Licenses/Permits shall provide the Complainant and the Licensee with a copy of the report. Either the Complainant or Licensee may make an objection, orally or in writing, to the report and shall have the opportunity to present arguments supporting the objection to the Common Council. The Common Council shall determine whether the arguments shall be presented orally or in writing, or both. If the Common Council, after considering the Committee on Licenses/Permits' report and any arguments presented by the Complainant and Licensee, finds the complaint to be true, or if there is no objection to a report recommending a suspension, revocation or nonrenewal, the Licensee shall be suspended, revoked or not renewed as provided by law. If the Common Council finds the complaint untrue, the proceedings shall be dismissed without cost to the accused. The City Clerk shall give notice of each suspension, revocation or nonrenewal to the party whose License is affected.

CODE OF GENERAL ORDINANCES, 2021 - KENOSHA, WISCONSIN

The judgment of conviction of any Licensee, or employee or agent thereof, in any Municipal, State or Federal Court, irrespective of whether obtained following trial, plea agreement, or bond forfeiture, shall be prima facie proof of said violation for purposes of this Ordinance. However, in the instance of any judgment of conviction entered pursuant to a no contest plea, or considered in law to be rendered pursuant to a no contest plea, said judgment of conviction as a prima facie case may be rebutted. Further, mitigating circumstances may be introduced with respect to any judgment of conviction.

d. Application for Determination of Demerit Points. Any Licensee or the City Clerk, or his/her designee, or the City Attorney, or his/her designee, may, at any time, request the Common Council to determine whether or not conduct which has occurred constitutes a basis for demerit points, and, if so, how many demerit points. The Common Council, in making this determination, shall have before it the recommendation of the Committee and of the City Attorney's Office.

e. Commencement of Penalties. Penalties shall commence the day after they have been imposed by the Common Council. Days of suspension shall run consecutively.

f. Periodic Reports by Police Chief. The Police Chief shall file periodic reports with the City Attorney advising said City Attorney of conduct by any Licensee, or employees thereof, which may constitute a basis for disciplinary action. The City Attorney, at Licensee renewal time, or at any earlier time deemed appropriate, shall bring such matters to the attention of the Committee and make a recommendation on disciplinary action.

g. Off Premises Conduct of Patrons as a Basis for Disciplinary Actions. The off premises conduct of patrons of any premises licensed by this Chapter may be a basis for disciplinary action against such license subject to the following procedures:

(1) Initial Meeting. The Licenses/Permits Committee shall direct the Licensee to appear before it to discuss complaints and potential solutions. If mutual agreements are arrived at, the matter shall be held in abeyance to provide Licensee an opportunity to comply with such mutual agreements, which shall be reduced to writing and served upon Licensee.

(2) Committee Hearing on Proposed Order. In the event the initial meeting does not result in a mutual agreement to resolve complaints, the City Attorney shall draft a tentative order which mandates certain specific corrective action, and Licensee shall be served with a copy thereof and directed to appear before the Licenses/Permits Committee to discuss the proposed order. Following Licensee being heard, or being provided with an opportunity to be heard, the Finance Committee shall determine the proposed form of such order.

(3) Common Council Hearing on Proposed Order. Licensee shall be served with the proposed order of the Licenses/Permits Committee and be directed to appear before the Common Council to discuss the proposed order. Following Licensee being provided with an opportunity to be heard, the Common Council shall determine the final form of such order, which shall be served on Licensee.

(4) Violations. Violations of the final order of the Common Council, following service upon Licensee, shall constitute grounds for revocation in and of itself, or such other action as the Common Council deems appropriate.

h. Time For Action. Disciplinary action need not be commenced and completed in the same License year as of the offense occurred. Where disciplinary actions are not commenced and completed within a License term, a License shall be granted subject to a "NonRenewal Revocation Hearing", to be held as soon as practicable.

C. Regulations Respecting Premises. The premises to be used for an Amusement and Recreation Enterprise shall:

1. Where in a building or structure, have at least one (1) window having a pane of transparent glass no less than one (1) square foot in size at a point of public access from which the interior of the licensed premises may be viewed. The base of said window shall be no higher than sixty-eight (68") inches from the viewing floor.

CODE OF GENERAL ORDINANCES, 2021 - KENOSHA, WISCONSIN

2. Have a minimum of two (2) easily available, marked and useful exits from the building.
3. During hours of operation, have unlocked entrances and exits.
4. Have separate, clean, adequate and immediately accessible washrooms and toilets for each sex on the licensed premises.
5. Be in compliance with the City's Zoning Ordinance and Code of General Ordinances.

Subsections 1. and 2. shall not apply if the premises to be licensed are within an enclosed mall. If said premises to be licensed are located in an enclosed mall, the Director of City Inspections may waive Subsection 4., where separate, clean, adequate and immediately accessible washrooms and toilets for each sex are located within the mall for general public use, unless the premises are the subject of a Restaurant Permit and has seating for dining.

D. Regulations Respecting Premises.

1. No licensee, agent, supervisor or employee of licensee shall permit any person under the age of eighteen (18) years to be present on the licensed premises between the hours of 8:00 A.M. and 2:30 P.M. on days which said minors are scheduled to be in school. Licensee shall post notice of this prohibition at the entrance of the licensed premises.

2. While open for business, all licensed premises shall be under the direct supervision of either the licensee, agent or licensed supervisor.

3. The holding of a license hereunder does not negate the requirement to hold other licenses or permits which may be applicable.

4. No gambling shall be permitted on the licensed premises.

5. No alcoholic beverages shall be served, consumed, or permitted on the licensed premises without an appropriate license.

6. No person who is visibly under the influence of alcoholic beverages or controlled substances shall be allowed to enter or remain on the licensed premises.

7. No person shall be permitted to conduct themselves in a disorderly manner on the licensed premises and the licensee shall obey any reasonable order of the Police Department to terminate or prevent such disorderly conduct.

8. There shall be compliance with State and County Obscenity laws.

9. Frequenters of the licensed premises shall not be permitted to congregate on the parking lot or public walks and thoroughfares adjacent to said premises.

10. There shall be no controlled substances permitted on the licensed premises.

11. Licensee shall comply with City, County, State or Federal laws, rules and regulations which are applicable to the licensed premises.

12. The licensee shall notify the Police Department of the hours of operation.

13. Chapter XXIII of the Code of General Ordinances, "NOISE CONTROL", shall be strictly complied with.

14. Licensee shall maintain the same closing hours as govern Retail Class "B" Licenses under Chapter 125, Wisconsin Statutes.

15. No Licensee, agent, supervisor or employee of Licensee shall permit any minor person to be on the licensed premises in violation of §11.05 of the Code of General Ordinances, entitled "Curfew", as said Ordinance now exists or may be amended in the future.

CODE OF GENERAL ORDINANCES, 2021 - KENOSHA, WISCONSIN

E. Safe Design And Operation. The purpose of this Ordinance is to provide an opportunity for City Code inspection and enforcement and to promote the orderly operation of the licensed premises. The Licensee is solely responsible for the safe design and operation of the licensed premises.

F. Liability Insurance. Any Licensee who does not maintain a policy of liability insurance shall conspicuously post notice of such lack of insurance at every entrance to the licensed premises.

G. Off Premises Conduct Of Patrons As A Basis For Disciplinary Actions. The off premises conduct of patrons of any Licensee may be a basis for disciplinary action against such Licensee subject to the following procedures:

1. Initial Meeting. The Committee on Licenses/Permits shall direct the Licensee to appear before it to discuss complaints and potential solutions. If mutual agreements are arrived at, the matter shall be held in abeyance to provide Licensee an opportunity to comply with such mutual agreements, which shall be reduced to writing and served upon Licensee.

2. Committee Hearing On Proposed Order. In the event the initial meeting does not result in a mutual agreement to resolve complaints, the City Attorney, or designee thereof, shall draft a tentative order which mandates certain specific corrective action, and Licensee shall be served with a copy thereof and directed to appear before the Committee on Licenses/Permits to discuss the proposed order. Following Licensee being heard, or being provided with an opportunity to be heard, the Committee on Licenses/Permits shall determine the proposed form of such order.

3. Common Council Hearing On Proposed Order. Licensee shall be served with the proposed order of the Committee on Licenses/Permits and be directed to appear before the Common Council to discuss the proposed order. Following Licensee being provided with an opportunity to be heard, the Common Council shall determine the final form of such order, which shall be served on Licensee.

4. Violations. Violations of the final order of the Common Council, following service upon Licensee, shall constitute grounds for disciplinary action.

H. Violations. Each calendar day of a violation of this Ordinance continues shall be considered a separate offense.

12.02 CIRCUS, MENAGERIE, ETC.

A. Granting License. The Mayor, in his discretion and upon conditions he deems advisable, may grant a license to any person, firm, or corporation to conduct for gain any circus, menagerie, or other entertainment given in open air, or partially or wholly under canvas. He may likewise grant a permit for a parade to be given in connection with any such entertainment. When an activity would otherwise require a license pursuant to this Ordinance, it is exempt from the licensing requirements described herein when the activity has been permitted pursuant to a Special Event Permit issued pursuant to Section 12.06 of the Code of General Ordinances.

B. License Fees.

1. For circus or kindred entertainment which uses Twenty-five Dollars or less in transportation, the sum of One Hundred (\$100) Dollars per day; an additional fee of Two (\$2.00) Dollars shall be charged for each railroad car above twenty-five.

2. For mobile petting zoos (10 (ten) animals or less), dog and pony shows, animal rides or similar events, Twenty-five (\$25.00) Dollars per day.

3. For theatrical, variety, vaudeville, burlesque, operatic or other performance given under a tent and every open air show, not less than Five (\$5.00) Dollars nor more than Twenty-five (\$25.00) Dollars per day.

4. Parades.

a. No fee shall be charged for a parade where the entertainment has been licensed above.

CODE OF GENERAL ORDINANCES, 2021 - KENOSHA, WISCONSIN

b. Where entertainment has not been licensed, the parade fee for circus shall be Fifty (\$50.00) Dollars per parade; for dog and pony show, Twenty-five (\$25.00) Dollars per parade.

C. Miscellaneous. Residents, local societies and local organizations may give musical entertainments without license charge.

12.03 CARNIVALS

A. Definitions. Carnival is defined as a place of amusement conducted for less than thirty (30) days upon property not owned by the provider of said amusement, where said amusement is in the nature of more than two (2) rides, and/or games of skill or chance, and/or incidental live entertainment.

B. Prohibition. No person, party, firm or corporation shall operate or maintain a carnival within the City limits without a permit issued pursuant to this Section, without a Special Event Permit issued pursuant to Section 12.06 of this Code, or contrary to the terms of this Ordinance.

C. Application and Fee. Applications for a carnival license shall be made on forms provided by the City Clerk. There shall be a Fifty (\$50.00) Dollar license fee, payable in advance. Applications shall be approved by the Common Council, following review by the Committee on Public Safety & Welfare. However, in the event that there is not a Council meeting from the time an application is submitted and prior to the event, the permit may be approved by the Mayor after consultation with the alderman of the district in which the carnival is to operate.

D. Requirements.

1. A condition of such license shall be the furnishing of a Certificate of Insurance, containing a provision that the City Clerk shall be notified twenty (20) days in advance of the effective date of any termination or cancellation thereof, which Certificate shall indicate that there is, in full force and effect, a policy of public liability insurance and motor vehicle liability insurance for each motor vehicle used in conjunction with the licensed activity, issued by an insurance company licensed to do business in the State of Wisconsin, in the amount of Two Million (\$2,000,000.00) Dollars protecting against claims involving death and personal injury, and One Hundred Thousand (\$100,000.00) Dollars protecting against claims involving property damage.

2. License holders must obey all laws, rules and regulations of the State of Wisconsin and the City of Kenosha.

3. License holders shall not create or maintain a private, public or attractive nuisance.

4. License holders must maintain safe equipment and operate same in a sanitary and safe environment and take this license with the understanding that the Mayor, Director of City Inspections, Health Administrator or Fire Chief may suspend operation thereof for twenty-four (24) hours pending an investigation of any unsafe condition. A longer suspension or license termination shall require notice and a hearing, with decisions appealable to the Common Council.

E. Separate Offense. Each day of violation of this Ordinance shall be deemed as a separate offense.

12.04 THEATERS

A. Definitions.

1. **Good Moral Character** shall mean to be law abiding, to conduct regulated activity in accordance with licensing and permitting regulations, to honor lawful contractual obligations, and to be honest and trustworthy.

2. **Motion Pictures** shall mean a sequence of pictures, each different from the last, photographed for projection on a screen. The term shall specifically include but not be limited to the projection of 8mm or other sized films, the playing of prerecorded videotapes, or the projection of a series of slides of transparent film. The term shall be independent of the size, shape, composition, or function of the screen upon which the motion picture is viewed. The term motion picture shall specifically exclude interactive video

CODE OF GENERAL ORDINANCES, 2021 - KENOSHA, WISCONSIN

games as might otherwise be subject to regulation under Section 12.01 of the Code of General Ordinances.

3. Theaters shall mean a place, whether indoor or outdoor, used for the showing of motion pictures, the performance of plays, concerts, shows or live entertainment.

B. Licenses Required.

1. License and Fee. No person, party, firm or corporation shall operate or maintain any premises as a theater without first obtaining from the Common Council a license for the purpose. If the applicant be a firm or corporation, it shall appoint an agent, named in the application, who shall be subject to approval by the Common Council and who shall have all the qualifications of a person applying for a license. The fee for such a license, which shall be for a period of one (1) year, shall be Five Hundred (\$500) Dollars. The license period shall be June 1st through the following May 31st. Licensees and agents must be persons, eighteen (18) years of age or older, and of good moral character. The license shall be valid only with respect to the premises described in the application, as approved by the Common Council.

a. Application. Application for such a license shall be made to the City Clerk in writing, accompanied by the required fee. Such application shall be fully completed on City forms, and shall define all areas and rooms of premises designated to be licensed.

b. Inspection and Recommendation. Upon receipt of any application, the City Clerk shall send copies thereof to the Department of City Inspections, County Health Department, and Fire Department who, within ten (10) days of receiving such copies, shall make a report, in writing, as to whether the premises upon which a licensed activity will be conducted meet the requirements in Subsection "C". with any other pertinent information. The Fire Department shall determine the seating or holding capacity of the premises to be licensed. The City Clerk shall also send a copy of the application to the Police Department, who shall report, in writing, to the City Attorney, as to any police record of applicant which may reflect upon good moral character. The City Attorney, or designee thereof, shall examine said record and make a recommendation based thereon as to whether or not the license should be granted or agent status approved. A recommendation for denial shall consider only such portions of the record as are materially related to the licensed activity. Such reports shall be delivered to the City Clerk who, in turn, shall deliver them, with the application, to the Committee on Licenses/Permits. Such Committee shall recommend to the Common Council either the granting or denial of the application.

c. Application for Fee Waiver. Not for profit corporations operating as a community theatre for the purpose of promoting art and culture may apply to the Common Council for a waiver of the license fee for the year covered by the license application.

d. Exemptions from Licensing Requirement. The following shall be exempt from the licensing provisions of this Ordinance:

(i) Premises operated or activities sponsored by a unit of government upon submission of written confirmation by the unit of government.

(ii) Premises operated or activities sponsored by any accredited school, school system or college.

(iii) Premises zoned and used for residential purposes.

(iv) Premises of churches, synagogues, mosques, or other bona fide religious institutions where shows, motion pictures, skits, pageants, or plays are periodically performed or shown with or without charge to the public.

(v) Premises licensed under Section 12.01 of the Code of General Ordinances entitled "Amusement and Recreation Enterprise".

(vi) Premises where the only activity subject to this Ordinance is a live lecture illustrated with projected transparent sheets or slides.

(vii) Premises which may be entered without charge upon which the only activity subject to this

CODE OF GENERAL ORDINANCES, 2021 - KENOSHA, WISCONSIN

Ordinance is the exhibition of motion pictures on a television monitor regardless of whether the motion pictures were received contemporaneously through electromagnetic signals or where from a prerecorded videotape.

(viii) Premises having and maintaining a Cabaret License under **Section 10.07** of the Code of General Ordinances where the capacity of the premises is less than five hundred (500) persons.

(ix) Premises used by a business for business presentations to employees and business affiliates.

(x) Premises operated pursuant to a Special Event Permit issued pursuant to Section 12.06 of the Code of General Ordinances

e. Temporary License. The Common Council may issue a Temporary License for a period not to exceed thirty (30) calendar days in any year and waive any regulations respecting premises which are not applicable due to the nature of the event and/or premises. The fee shall be Fifty (\$50.00) Dollars for any period of consecutive days within the thirty (30) day limit for such license. The Common Council may waive the fee in accordance with Subsection B.1.c. The license may be conditioned in accordance with recommendations made by departments conducting inspections and making recommendations to the Committee on Licenses and Permits, and the Common Council.

2. Revocation, NonRenewal and Suspension of Licenses. The Common Council, for just cause, may suspend, revoke, or not renew any license or agent status herein provided, upon serving upon such party written notice of the charges forming a basis for the proposed penalty, in the same manner as that for the service of a Summons in a civil action. Service upon an appointed agent shall be deemed service upon a corporation. Said notice shall provide for a hearing upon a written request therefor being filed with the City Clerk within ten (10) days of service. Absent a timely request for a hearing, the City Clerk shall administratively impose the penalty set forth in said notice.

3. Disciplinary, NonRenewal, Suspension and Revocation Hearings. Disciplinary hearings, including nonrenewal, suspension and revocation hearings, shall be held before the Committee on Licenses/Permits, which shall submit a report to the Common Council, including Findings of Fact, Conclusions of Law and a recommendation as to what action, if any, the Common Council should take with respect to the License. The Committee on Licenses/Permits shall provide the Complainant and the Licensee with a copy of the report. Either the Complainant or Licensee may make an objection, orally or in writing, to the report and shall have the opportunity to present arguments supporting the objection to the Common Council. The Common Council shall determine whether the arguments shall be presented orally or in writing, or both. If the Common Council, after considering the Committee on Licenses/Permits' report and any arguments presented by the Complainant and Licensee, finds the complaint to be true, or if there is no objection to a report recommending a suspension, revocation or nonrenewal, the Licensee shall be suspended, revoked or not renewed as provided by law. If the Common Council finds the complaint untrue, the proceedings shall be dismissed without cost to the accused. The City Clerk shall give notice of each suspension, revocation or nonrenewal to the party whose License is affected.

The judgment of conviction of any Licensee, or employee or agent thereof, in any Municipal, State or Federal Court, irrespective of whether obtained following trial, plea agreement, or bond forfeiture, shall be prima facie proof of said violation for purposes of this Ordinance. However, in the instance of any judgment of conviction entered pursuant to a no contest plea, or considered in law to be rendered pursuant to a no contest plea, said judgment of conviction as a prima facie case may be rebutted. Further mitigating circumstances may be introduced with respect to any judgment of conviction.

4. Commencement Of Penalties. Penalties shall commence the day after they have been imposed by the Common Council. Days of suspension shall run consecutively.

5. Periodic Reports By Police Chief. The Police Chief shall file periodic reports with the City Attorney advising said City Attorney of conduct by any Licensee, or employees thereof, which may constitute a basis for disciplinary action. The City Attorney, at License renewal time, or at any earlier time deemed appropriate, shall bring such matters to the attention of the Committee and make a recommendation on disciplinary action.

CODE OF GENERAL ORDINANCES, 2021 - KENOSHA, WISCONSIN

6. Off Premises Conduct Of Patrons As A Basis For Disciplinary Actions. The off premises conduct of patrons of any premises licensed by this Chapter may be a basis for disciplinary action against such license, subject to the following procedures:

a. Initial Meeting. The Licenses/Permits Committee shall direct the Licensee to appear before it to discuss complaints and potential solutions. If mutual agreements are arrived at, the matter shall be held in abeyance to provide Licensee an opportunity to comply with such mutual agreements, which shall be reduced to writing and served upon Licensee.

b. Committee Hearing On Proposed Order. In the event the initial meeting does not result in a mutual agreement to resolve complaints, the City Attorney shall draft a tentative order which mandates certain specific corrective action, and Licensee shall be served with a copy thereof and directed to appear before the Licenses/Permits Committee to discuss the proposed order. Following Licensee being heard, or being provided with an opportunity to be heard, the Finance Committee shall determine the proposed form of such order.

c. Common Council Hearing On Proposed Order. Licensee shall be served with the proposed order of the Licenses/Permits Committee and be directed to appear before the Common Council to discuss the proposed order. Following Licensee being provided with an opportunity to be heard, the Common Council shall determine the final form of such order, which shall be served on Licensee.

d. Violations. Violations of the final order of the Common Council, following service upon Licensee, shall constitute grounds for revocation in and of itself, or such other action as the Common Council deems appropriate.

7. Time For Action. Disciplinary action need not be commenced and completed in the same License year as of the offense occurred. Where disciplinary actions are not commenced and completed within a License term, a License shall be granted subject to a "NonRenewal Revocation Hearing", to be held as soon as practicable.

C. Regulations Respecting Premises. The premises to be used for a theater shall:

1. Have a minimum of two (2) easily available, marked and useful exits from the building.
2. During hours of operation, have unlocked entrances and exits.
3. Have separate, clean, adequate and immediately accessible washrooms and toilets for each sex on the licensed premises.
4. Be in compliance with the City's Zoning Ordinance and Code of General Ordinances.

D. Regulations Respecting Operation of Premises.

1. No licensee, agent, or employee of licensee shall permit any person under the age of eighteen (18) years to be present on the licensed premises between the hours of 8:00 A.M. and 2:30 P.M. on days which said minors are scheduled to be in school, unless the students' school has authorized an absence from school for a specified date and time. Licensee shall post notice of this prohibition at the entrance of the licensed premises.

2. The holding of a license hereunder does not negate the requirement to hold other licenses or permits which may be applicable.

3. No gambling shall be permitted on the licensed premises.

4. No alcoholic beverages shall be served, consumed, or permitted on the licensed premises without an appropriate license.

5. No person who is visibly under the influence of alcoholic beverages or controlled substances shall be allowed to enter or remain on the licensed premises.

6. No person on the licensed premises shall be permitted to conduct themselves in a manner as to

CODE OF GENERAL ORDINANCES, 2021 - KENOSHA, WISCONSIN

interfere with the peaceful enjoyment of the premises by other patrons or in an otherwise disorderly manner. The licensee shall obey any reasonable order of the Police Department to terminate or prevent such conduct.

7. There shall be compliance with State and County Obscenity laws.
8. Frequenters of the licensed premises shall not be permitted to congregate on the parking lot or public walks and thoroughfares adjacent to said premises, unless standing in line for admission.
9. There shall be no controlled substances permitted on the licensed premises.
10. Licensee shall comply with City, County, State or Federal laws, rules and regulations which are applicable to the licensed premises.
11. The licensee shall conspicuously post the hours of operation of the licensed premises at the main entrance.
12. **Chapter XXIII** of the Code of General Ordinances, "NOISE CONTROL", shall be strictly complied with.
13. Licensee shall maintain the same closing hours as govern Retail Class "B" Licenses under Chapter 125, Wisconsin Statutes.
14. No Licensee, agent, supervisor or employee of Licensee shall permit any minor person to be on the licensed premises in violation of **§11.05** of the Code of General Ordinances, entitled "Curfew", as said Ordinance now exists or may be amended in the future.
15. Licensee shall post the seating or holding capacity of the premises, as determined by the Fire Department, at or near the main entrance to the premises. Licensee shall not permit patrons on the licensed premises beyond the seating or holding capacity as determined by the City Fire Department, and shall not obstruct or permit the obstruction of aisles, fire exits and doorways.
16. Licensee shall maintain licensed premises in accordance with section entitled "Regulations Respecting Premises".

E. Safe Design And Operation. The purpose of this Ordinance is to provide an opportunity for City Code inspection and enforcement and to promote the orderly operation of the licensed premises. The Licensee is solely responsible for the safe design and operation of the licensed premises.

F. Liability Insurance. Any Licensee who does not maintain a policy of liability insurance shall conspicuously post notice of such lack of insurance at every entrance to the licensed premises.

G. Violations. Each calendar day of a violation of this Ordinance continues shall be considered a separate offense.

12.05 PUBLIC ENTERTAINMENT LICENSE

A. License Required. No commercial enterprise shall perform, engage in, or permit, the following activity by employees, patrons, or hired performers upon the business premises without first having obtained a Public Entertainment License from the City Clerk:

1. Live music performances;
2. Live entertainment, including, but not limited to, the performance of any act, play or stunt, dramatic reading, monologue, amateur talent contest, or disc jockey show.

B. Application. Upon application to the City Clerk and the payment of the fee therefor, a Public Entertainment License will be issued subject to the conditions and regulations set forth in this Section. An application for a license provided for in this Section shall be made to the City Clerk in writing, accompanied by the required fee. Applications shall be on City forms and shall be true, correct and complete in all respects. No application for such license shall be accepted unless accompanied by the appropriate fee. In

CODE OF GENERAL ORDINANCES, 2021 - KENOSHA, WISCONSIN

determining whether a Public Entertainment License should be granted, the Common Council shall consider the following factors, giving to each whatever weight is appropriate in the particular factual circumstances:

1. Whether the proposed license will have a substantial negative impact upon the surrounding properties or the neighborhood within 5,280 feet of the licensed premises, in terms of increasing noise, as defined in Chapter 23 of the Code of General Ordinances, and/or traffic congestion.
2. The availability and type of parking on or off the proposed licensed premises.
3. The existing or planned character of the neighborhood.
4. Applicant's compliance and past performance with any/all licensing laws.

C. License Term.

1. Annual License. The Annual License shall expire on June 30th following its issuance. The Annual License is a one (1) term license which is nonrenewable. A new Annual License application shall be filed for review for each subsequent license term.

2. One (1) Day License. A One Day License may be issued for one (1) day only. The One (1) Day License application shall designate the date the One (1) Day License will be utilized.

D. License Fees.

1. Annual License. The Annual License Fee shall be Three Hundred (\$300.00) Dollars.

2. One (1) Day License. The One (1) Day License fee shall be Fifty (\$50.00) Dollars.

E. License Application Review and Recommendation. Applications shall be referred by the City Clerk to the Police Department. The Police Department shall make a report, in writing, to the City Attorney as to any police record of the applicant, which may reflect upon good moral character or business responsibility. The City Attorney shall examine said record and make a recommendation to the Committee on Licenses/Permits based thereon as to whether the license shall be granted. The Committee on Licenses/Permits shall review all applications, any reports, the recommendation of the City Attorney and all other information before it. Said Committee shall recommend to the Common Council either the granting or denial of each application.

F. Exemptions from Licensing Requirement. The following shall be exempt from the licensing provisions of this Ordinance:

1. Premises operated or activities sponsored by a unit of government upon submission of written confirmation by the unit of government.
2. Premises operated or activities sponsored by any accredited school, school system or college.
3. Premises zoned and used exclusively for residential purposes.
4. Premises of churches, synagogues, mosques, or other bona fide religious institutions where shows, motion pictures, skits, pageants, or plays are periodically performed or shown with or without charge to the public.
5. Premises licensed under Section 12.01 of the Code of General Ordinances entitled "Amusement and Recreation Enterprise."
6. Premises where the only activity subject to this Ordinance is a live lecture illustrated with projected transparent sheets or slides.
7. Premises having and maintaining a Cabaret License under Section 10.07 of the Code of General Ordinances.

CODE OF GENERAL ORDINANCES, 2021 - KENOSHA, WISCONSIN

8. Premises used by a business for business presentations to employees.
9. Premises licensed under Section 12.04 of the Code of General Ordinances entitled "Theaters".
10. Premises operated pursuant to a Special Event Permit issued pursuant to Section 12.06 of the Code of General Ordinances.

G. Regulations.

1. Good order shall be maintained at all times.
2. The management shall obey all reasonable orders or directions of any police officer.
3. Adequate parking accommodations may be deemed necessary by the Police Department and/or Licensing/Permit Committee for safety reasons; lighted parking facilities may be maintained so as to accommodate anticipated capacities.
4. No license holder personally or through his agent or employee shall permit any patron to participate in any performance with performers who are under the auspices or furnished by the management.
5. No patron shall participate in any performance by performers who appear under the auspices of the management.
6. No Licensee, agent, or employee of the licensee shall permit any person under the age of eighteen (18) years to be present on the licensed premises between the hours of 8:00 A.M. and 2:30 P.M. on days which said minors are scheduled to be in school, unless the school has authorized an absence from school for a specified date and time. The Licensee shall post notice of this prohibition at the entrance of the licensed premises.
7. No alcoholic beverages shall be served, consumed, or permitted on the licensed premises without an appropriate license.
8. There shall be compliance with local, County and State obscenity laws.
9. There shall be no controlled substances permitted on the licensed premises.
10. The Licensee shall comply with City, County, State or Federal laws, rules and regulations which are applicable to the licensed premises.
11. Strict compliance with Chapter XXIII of the Code of General Ordinances, "NOISE CONTROL", shall be required.
12. No Licensee, agent, supervisor or employee of the Licensee shall permit any minor person to be on the licensed premises in violation of §11.05 of the Code of General Ordinances, entitled "Curfew", as said Ordinance now exists or may be amended in the future.

13. Annual License Framed, Posted.

- a. Frame. An Annual License shall be enclosed in a frame having a transparent front which allows the license to be clearly read.
- b. Display. All Annual Licenses under Paragraph a. shall be conspicuously displayed for public inspection at all times in the room or place where the activity subject to licensure is carried on.

H. Administrative Suspension. Upon written request made and filed with the City Clerk/Treasurer of the City of Kenosha by the Chief of Police, the Mayor may immediately suspend any license issued under this Section. A written order of administrative suspension shall be served upon the Licensee. All licensed activities shall remain suspended until completion of an administrative review hearing. Upon administrative suspension, an administrative review hearing shall be scheduled for license review within ten (10) days pursuant to the terms of Subsection 12.05 H. of this Ordinance.

CODE OF GENERAL ORDINANCES, 2021 - KENOSHA, WISCONSIN

I. Revocation of License.

1. Upon written charges made and filed with the City Clerk/Treasurer of Kenosha by the Chief of Police or any citizen, the Common Council may after a public hearing thereof revoke any license issued under this Section.

2. Conviction for the violation of any provision of the Wisconsin State Statutes materially related to the licensed activity, City of Kenosha Code of General Ordinances, Zoning Ordinance or sanitary codes shall be sufficient for the Common Council to revoke or suspend such license. In the event the license is revoked, no other Public Entertainment License shall be granted to such person for said location within twelve (12) months of the date of its revocation. A suspension shall not be for less than ten (10) days, nor more than ninety (90) days from the date of suspension. Any part of the money paid for any license revoked or suspended shall be forfeited and not refunded.

3. The Common Council may, after the hearing described in Subsection I., revoke the Public Entertainment License upon sufficient proof that the Licensee has permitted or suffered the licensed premises to be conducted by himself, his employees, patrons or others in violation of health regulations or in a disorderly or improper manner, or in violation of the laws of the State, or rules and regulations of the Common Council, or for any reasons set forth in Subsection 12.05 H.2.

J. Severability. Should any section, paragraph, sentence, clause or phrase of this Section be declared unconstitutional or invalid, or be repealed, it shall not effect the validity of the Ordinance as a whole or any part thereof other than the part so declared to be invalid or repealed.

12.06 SPECIAL EVENT PERMIT

A. Purpose. This ordinance is enacted to regulate and control Special Events and activities incidental to Special Events within the City of Kenosha to the extent that the health, safety, and general welfare of the public and the good order of the City can be protected and maintained. It is recognized that Special Events may include multiple activities which are subject to multiple municipal city licensing requirements. A permit issued pursuant to this section shall authorize all activities which would otherwise require a separate license to be issued pursuant to one or more of Sections 5.04, 6.05, 12.02, 12.03, 12.04, 12.05, 13.03, 13.035 or 14.025 of the Code of General Ordinances.

B. Definitions.

1. **Permit Term.** A period of time up to five (5) consecutive days or an approved number of reoccurring nonconsecutive dates authorized in a calendar year.

2. **Special Event.** An event, program or activity occurring on a scheduled date requiring one or more licenses issued pursuant to Sections 5.04, 6.05, 12.02, 12.03, 12.04, 12.05, 13.03, 13.035, or 14.025 of the Code of General Ordinances, lasting no longer than five (5) consecutive days or consisting of reoccurring nonconsecutive days, to which the general public is solicited or otherwise encouraged to attend and requiring authorized use of any City-owned or City-controlled property including streets, parking lots, lands, select public facilities or City parks that may or may not require City services. Types of Special Events include, but are not limited to, concerts, parades, festivals, athletic events, marches, ceremonies, tournaments, exhibitions, expositions, fairs, markets, or shows.

3. **Special Event Organizer.** An approved applicant for a Special Event.

4. **Reviewing Authority.** The Reviewing Authority for Special Events located in City parks shall be the Board of Park Commissioners. The Reviewing Authority for Special Events located on all other City owned property shall be the Board of Public Works.

5. **Vendor.** A person, firm, party or business entity who as part of a Special Event, offers anything for sale, trade, use or reuse, including but not limited to, articles, food, produce, beverage, goods, service, art, craft or product; or interacts with potential customers in or around the Special Event, taking names for the purpose of making future sales, offering applications or materials for future sales, or in any other participating operation or attempting to publicly sell or offer for sale any such article or service.

CODE OF GENERAL ORDINANCES, 2021 - KENOSHA, WISCONSIN

C. Permit Required. A Special Event Permit shall be required under this Ordinance prior to and as a condition of any person, party, firm or corporation undertaking a Special Event. A Special Event Permit shall be issued in the name of the Special Event Organizer, who shall be responsible for the conduct and supervision of all activities authorized under the Special Event Permit, whether or not said Special Event Organizer is present at the Special Event location. However, this does not preclude enforcement of statutory or ordinance violations against individuals conducting the activities under such permit. A Special Event Permit issued pursuant to this section shall authorize all activities which would otherwise require a separate License or Permit to be issued pursuant to Sections 5.04, 6.05, 12.02, 12.03, 12.04, 12.05, 13.03, 13.035 or 14.025 of the Code of General Ordinances.

D. Exceptions.

1. A Special Event organized and approved pursuant to a contract between the Special Event Organizer and the City of Kenosha, which requires compliance with the Standards For Permit Issuance and the Permit Conditions of this ordinance, which operates subject to the terms and conditions of the approved contract.

2. Activities which would otherwise be described as a Special Event which have been organized and approved pursuant to a lease agreement between an Event Organizer and the City of Kenosha.

3. An event operated pursuant to City Licenses issued pursuant to the Code of General Ordinances which will permit all planned activities upon written permission of the Reviewing Authority responsible for use of the City Property.

E. Application. Application for a Special Event Permit shall be fully completed, properly executed, and filed not more than three hundred sixty-five (365) days and not less than thirty (30) days prior to the Special Event with the Department of Administration on a form designed for that purpose. The application shall:

1. Identify the Special Event Organizer's name, address and telephone number(s);

2. Set forth the exact dates and times of the Special Event;

3. Describe the specific location of the premises for which a Special Event Permit is sought, including a scaled site plan, detailing locations for vending, entertainment, stages, portable restrooms, tents, parking, garbage collection, etc.;

4. Include an operational plan describing the Special Event and detailing actions the Special Event Organizer will take to support the objectives of this Ordinance. The operational plan must address the Permit Standards (Section H) and Permit Conditions (Section I) of this Ordinance;

5. Describe all City Services required;

6. Any other relevant information requested on the application form which is reasonably necessary to a fair determination as to whether the Special Event Permit should be issued.

F. Permit Application Fee. If filed forty-five (45) days or more prior to the Special Event, the non-refundable permit fee shall be one hundred dollars (\$100.00) per event application. If filed less than forty-five (45) days, but at least thirty (30) days prior to the Special Event, the non-refundable permit fee shall be five hundred dollars (\$500.00) per event application. The following types of Special Events are exempt from paying the licensing fee if the application is filed forty-five (45) days or more prior to the date of the Special Event:

1. A Special Event presented by the City of Kenosha pursuant to designated City funding in the annual budget or an authorizing Resolution approved by the Common Council shall be deemed to be a Permitted Special Event.

2. Activities sponsored and organized by an accredited school, school system, college, bonafide youth organizations, bonafide veteran's organization, church or bonafide religious organization upon authorization of the Reviewing Authority responsible for use of the City Property.

CODE OF GENERAL ORDINANCES, 2021 - KENOSHA, WISCONSIN

G. Review and Appeal. Applications for Special Event Permits shall be referred by the Department of Administration to the Department of Public Works, Department of Community Development and Inspection, Police Department, Fire Department, and the Kenosha County Health Department and any other affected City Department for review and written comment. Within ten (10) days of receiving the application the Department of Public Works, the Department of City Development, Department of City Inspections, Police Department, Fire Department and any other affected City Department shall send their comments to the Department of Administration to be forwarded to the Reviewing Authority for consideration. Upon the conclusion of the ten (10) day Departmental review period, the Reviewing Authority shall complete its review and grant, grant with conditions or deny the application within twenty-eight (28) days. An application not granted or denied by the Reviewing Authority within twenty-eight (28) days shall be deemed granted. Whenever a permit application is denied, a statement of the reason(s) for denial shall be provided to the applicant in writing. The decision of the Reviewing Authority may be appealed to the Common Council by filing a written notice of appeal with the City Clerk within five (5) business days following, but not including, the date of the written denial. The appeal will be heard at a regularly scheduled meeting of the Common Council as soon as practicable. However, to be heard at a given Common Council meeting, the notice of appeal must be filed a minimum of two (2) business days prior to said meeting, not including the day of the scheduled meeting.

H. Standards For Permit Issuance. The Reviewing Authority shall consider the following standards for permit issuance and grant a permit only upon finding that:

1. The proposed Special Event is incidental to an appropriate recreational or cultural use of the location.
2. The operational plans submitted by the Special Event Organizer will promote the health, safety and general welfare of the public and the good order of the City.
3. The activity or use will be in compliance with applicable Federal, State, County and City laws, rules and regulations.
4. The activity or use will not create an unreasonable risk of loss of life, personal injury or property loss or damage or otherwise threaten the public health, safety or welfare.
5. The activity or use will not unreasonably interfere with the use of the location by the general public.
6. The activity or use will not entail an unusual, extraordinary or burdensome expense to the City which is not recovered in the permit fees or charges.
7. The area which is the subject of the application is not reserved for another use on the date(s) requested.

I. Permit Conditions. Because all Special Events are unique and independent in terms of type, purpose, location, size, duration and participation, presenting unique issues and circumstances and challenges with regard to the health, safety and general welfare of the public, the Reviewing Authority, as a condition of issuance, may adopt reasonable operational rules, regulations and requirements for the Special Event. Notwithstanding the foregoing, the following Permit Conditions are applicable to all Special Events:

1. Compliance with applicable Federal, State, County and City laws, rules and regulations including licensing conditions and operational requirements contained within Sections 5.04, 6.05, 12.02, 12.03, 12.04, 12.05, 13.03, 13.035 and 14.025 when a Special Event activity would otherwise require a License or Permit issued pursuant to one of those Sections by the Special Event Organizer and vendors.
2. Execution of an Indemnity and Hold Harmless Agreement.
3. Provide private security for traffic, parking and/or crowd control.
4. Clean up area immediately following use.
5. Supervise all persons using the location under authority of the Special Event Permit to ensure

CODE OF GENERAL ORDINANCES, 2021 - KENOSHA, WISCONSIN

compliance with the Permit Conditions.

6. Reimbursement to the City of costs incurred in enforcing Permit Standards and Conditions.
7. Procure and maintain one (1) or more liability insurance policy(ies) written by one (1) or more insurance company(ies) licensed to do business in the State of Wisconsin as required by paragraph L of this Ordinance.
8. Procure any other license or permit required for the activity.
9. No later than fourteen (14) days prior to the event, submit a list of all vendors who will be vending during the Special Event. If a Special Event consists of reoccurring non-consecutive days, the vendor list must be amended to reflect additions when applicable.

J. City Services. Special Events provide recreational programs which are an enhancement to the quality of life for the residents of the City to which the City may contribute City Services. If the Special Event will require the use of City equipment or services, exclusive of a showmobile or snow fencing, the Special Event Organizer shall pay the cost, as determined by the City Staff, for the use of such equipment or services as follows:

1. Actual costs up to \$500.00 for a Special Event lasting ten (10) days or more.
2. Actual costs up to \$250.00 for a Special Event lasting five (5) to nine (9) days.
3. Actual costs up to \$150.00 for a Special Event lasting up to four (4) days.

This may include, but is not limited to, equipment rental; equipment installation; personnel costs for set up and tear down; and waste removal. As a condition of approval of an application, the applicant shall pay, at the time the application is filed, the cost of any City Services identified. The cost for use of City Venues with regularly established fees, for a showmobile, for snow fencing, for Protective Services provided by the Kenosha Police Department and the Kenosha Fire Department, as well as costs paid to third parties, even if charged by the City, such as utility charges and insurance premiums, shall be the sole responsibility of the Special Event Organizer. All charges shall be paid in full within thirty (30) days of billing.

A Special Event presented by the City of Kenosha pursuant to designated City funding in the annual budget or an authorizing Resolution approved by the Common Council shall be exempt from paying the costs described herein.

K. Issuance. To assure that conditions and insurances are in place throughout the Special Event, proof of insurances required pursuant to paragraph L., shall be a condition of issuance.

L. Insurance.

1. The Special Event Organizer shall, at a minimum, procure and maintain during the term of the Special Event occurrence based insurance policies, hereinafter specified insuring the Special Event and all associated Special Event activities. The Reviewing Authority may require additional coverages and/or increased coverage when deemed necessary.

a. Commercial General Liability:

General Aggregate - Two Million Dollars (\$2,000,000.00)
Each Occurrence - One Million Dollars (\$1,000,000.00)

b. Automobile Liability: (When required as a permit condition)

Combined single limit coverage for bodily injury and property damage per accident in the amount of One Million Dollars (\$1,000,000.00).

c. Liquor Liability Coverage (When alcohol is approved for the Special Event)

General Aggregate - One Million Dollars (\$1,000,000.00)

CODE OF GENERAL ORDINANCES, 2021 - KENOSHA, WISCONSIN

Each Occurrence - One Million Dollars (\$1,000,000.00)

Umbrella Liability in the following amounts over the Commercial General Liability and Automobile Liability amounts listed herein: (When required as a permit condition)

Two Million Dollars (\$2,000,000.00) per person

Two Million Dollars (\$2,000,000.00) aggregate

The Commercial General Liability coverages required herein may be subject to a deductible or self-insured retention. If the Commercial General Liability insurance coverage policy has a deductible or self-insured retention, said deductible or self-insured retention cannot exceed \$5,000.00. The Umbrella Liability policy shall not contain exclusions or exceptions not present in the General Liability insurance policy.

2. Certificate of Insurance. The insurance coverages listed above shall be verified by a Certificate of Insurance issued to the City and shall provide that should any of the described policies be canceled before the expiration date thereof, the issuing company will mail ten (10) days written notice to the certificate holder.

3. Additional Named Insured Endorsement. City and the Reviewing Authority must be named as additional insureds on the Commercial General Liability, Automobile Liability, Liquor Liability and the Umbrella Liability. The Special Event Organizer shall provide the City with a copy of the Endorsement(s) naming the City and the Reviewing Authority as additional insureds.

4. Cancellation Endorsement. All insurance policies maintained pursuant to this section will provide by endorsement that they may not be terminated nor may coverage be reduced except after (10) days' prior written notice to the City and the Reviewing Authority. The Special Event Organizer shall provide the City and the Reviewing Authority with a copy of the Cancellation Endorsement.

5. Primary Insurance Endorsement. All policies maintained pursuant to this section will provide by endorsement that said policies are primary, not contributing with and not supplemental to the coverage that the City or Reviewing Authority may carry. The Special Event Organizer shall provide the City and the Reviewing Authority with a copy of the Primary Coverage Endorsement.

6. Waiver of Subrogation Endorsement. All policies maintained pursuant to this section shall by endorsement, waive all claims of subrogation and/or contribution against the City or the Reviewing Authority the Insurer may have arising out of the Special Event. The Special Event Organizer shall provide the City and the Reviewing Authority with a copy of the Waiver of Subrogation Endorsement.

M. Laws. There must be strict compliance with all applicable laws, specifically including the Fire Prevention Code and related permit requirements embodied in Chapter 3, Good Order and Conduct Ordinances embodied in Chapter 11, the Noise Ordinances embodied in Chapter 23, and when alcohol is served obtaining State required licenses embodied in Chapter 10 of the Code of General Ordinances.

N. Safety. The Special Event Organizer shall assure the safety of vendors and attendees of the Special Event by periodically each day inspecting the event location, said inspection specifically including but not limited to, reviewing electrical connections, reviewing the condition of electrical conductors and cables, and mitigating potential trip hazards.

O. Protective Service Accessibility. At any time during the application review process or during the operation or maintenance of the Special Event, the Special Event Organizer and every affected Vendor shall comply with the orders or directives of members of the Police Department or Fire Department regarding the keeping of accessibility lanes open for potential and actual emergency response. Failure to comply with such lawful orders or directives is a violation of this Ordinance, which may result in the closure of a portion of the Special Event, closure of the entire Special Event, and/or citations appropriate under the Code of General Ordinances.

P. Operational Regulation. A Special Event must be operated in strict compliance with the terms of

CODE OF GENERAL ORDINANCES, 2021 - KENOSHA, WISCONSIN

this Ordinance, the approved application and supporting documentation and all permit conditions adopted by the Reviewing Authority. Failure to do so shall be subject to an order to suspend and terminate the Special Event or Event activities at the sole discretion of the enforcement authorities in furtherance of this Ordinance.

Q. Enforcement. The enforcement of this Ordinance shall be under the jurisdiction of the Public Works Department and Kenosha Police Department, who shall have the authority to inspect a Special Event to determine compliance with this Ordinance.

R. Suspension or Revocation of Permit. The Reviewing Authority may suspend or revoke any Permit issued hereunder which is operated contrary to the terms of a Permit issued under this Ordinance, upon providing Permit holder with a reasonable time, not to exceed ten (10) days, in which to file a written request with the City Clerk/Treasurer to be heard in said matter, and show cause why the proposed action should not be taken. However, a Permit may be administratively suspended by an Enforcing Authority identified in paragraph Q without prior notice or opportunity to be heard where it constitutes an immediate danger to the public health, safety or welfare, where the Special Event is not operated in conformance with representations made in the application and the approved permit contrary to the provisions of this Ordinance. In such cases, an opportunity for a post-removal hearing shall be provided following the foregoing provisions for an appeal.

S. Penalty. Any person, firm, corporation or permittee who violates any provision of this Ordinance, shall, upon conviction, forfeit not less than Two Hundred Dollars (\$200.00) and not more than Five Hundred Dollars (\$500.00), plus costs of prosecution, in addition to all applicable surcharges and assessments. A person may be incarcerated in the County Jail for not more than ninety (90) days for nonpayment of their forfeiture.

12.07 PENALTIES

Anyone violating any of the provisions of this Chapter, upon conviction thereof, shall be subject to a forfeiture not to exceed Five Hundred (\$500) Dollars, plus the payment of the costs of prosecution, and in default of the timely payment thereof, shall be committed to the County Jail until such forfeiture has been paid, but for a period not to exceed sixty (60) days.

CODE OF GENERAL ORDINANCES, 2021 - KENOSHA, WISCONSIN

CHAPTER XIII BUSINESS LICENSES

13.01 SCRAP SALVAGE DEALERS AND SCRAP SALVAGE COLLECTORS

A. Purpose. The Common Council of the City of Kenosha, Wisconsin makes the following findings:

1. "**Scrap Salvage**", as defined herein, is, or in the future may be, stored in a dangerous or unsanitary manner in yards, open areas or in other places within the City; and,
2. The places in which "Scrap Salvage", as defined herein, is stored, or in the future may be stored, tend to become overgrown with weeds, littered with rubbish and debris; and infested with rats, mice, insects, reptiles, and other vermin; and,
3. Such conditions tend to attract children and endanger their lives and health; spread disease; invite plundering; attract vagrants; create fire hazards and other safety and health hazards; create, extend, and aggravate urban blight; interfere with the enjoyment of and reduce the value of private property; and interfere with the comfort and well-being of the public; and,
4. Thieves and receivers of stolen property frequently attempt to dispose of stolen property by representing it to be legitimately acquired Scrap Salvage.

Based upon said findings, it is determined that adequate protection of the public health, safety, and welfare requires that the business of handling and dealing in Scrap Salvage be regulated and controlled, and such is the purpose of this Ordinance.

B. Definitions. Except where otherwise indicated by the context, the following definitions shall apply in the interpretation and enforcement of this Ordinance:

1. "**Exterior Premises**" has the definition given to the term in Chapter 16.
2. "**Fire Lane**" means a roadway that is accessible year round and of sufficient size, configuration and location so as to permit firefighting and emergency equipment access to all acres of the Scrap Salvage Yard.
3. "**Licensed Premises**" means the area of a Scrap Salvage Yard as described in a Scrap Salvage Dealer's license granted by the Common Council. The term "Licensed Premises" also means the area described in an application filed with the City Clerk for a Scrap Salvage Yard license before such application has been finally considered by the Common Council.
4. "**Person**" means any person, firm, partnership, association, corporation, company, or organization of any kind.
5. "**Scrap Salvage**" means any of the following or combination thereof: old iron, steel, brass, copper, tin, lead or other base metals; used lumber, used conveyor belts, used barrels, used appliances not intended for resale as such; old cordage, ropes, rags, fibers or fabrics; old tires or rubber; old bottles or other glass; bones; wastepaper and other waste or discarded material which might be prepared to be used again in some other form; and motor vehicles, no longer used as such, to be used for scrap metal or for the stripping of parts. Scrap Salvage shall not include materials or objects accumulated by a manufacturer as by-products, waste, or scraps from their own manufacturing process or used as an integral part of its own manufacturing process when stored upon manufacturer's premises, when Scrap Salvage is shielded from view by a fence meeting the requirements of Subsection K.1.o. of this Ordinance as to size and construction. Scrap Salvage shall not include used household furniture, used appliances taken in trade and held for less than thirty (30) days, used wearing apparel, railroad ties intended for landscaping purposes,

CODE OF GENERAL ORDINANCES, 2021 - KENOSHA, WISCONSIN

used brick and tile which is stacked and bound, used plumbing fixtures, excluding pipes, used precious metal or metals, used jewelry, used tools and other used articles or personal property, which are bought and sold, without substantial alteration, as secondhand property to be used for the purpose for which originally manufactured or produced. Scrap Salvage shall not include aluminum cans collected for the purpose of recycling or returnable glass bottles collected for the purpose of refilling when either is stored in a wholly enclosed building or structure.

6. "Scrap Salvage Collector" means a person who buys, sells, collects, or delivers Scrap Salvage which is acquired from another person as a business or employment within the City, but who is not an operator of a Scrap Salvage Yard within the City or an employee of such an operator.

7. "Scrap Salvage Dealer" means a person who operates a Scrap Salvage Yard, as defined above, within the City.

8. "Scrap Salvage Yard" means a yard, lot, or place, covered or uncovered, outdoors or in an enclosed building or structure, containing Scrap Salvage, as defined above, upon which occurs one or more acts of buying, keeping, dismantling, crushing, recycling, chipping, reducing, stripping, reusing, processing, selling, or offering for sale any Scrap Salvage, in whole units or by parts, for a business or commercial purpose, whether or not the proceeds from such act or acts are to be used for charitable purposes.

C. License Requirements/ Prohibitions/ Exceptions.

1. License Required. It shall be unlawful for any person to act as a Scrap Salvage Dealer or Scrap Salvage Collector within the City whether personally, by agents or employees, singly, or along with some other business or enterprise, without first having obtained a license therefor from the Common Council in accordance with the provisions of this Ordinance.

2. Separate Licenses. A Scrap Salvage Dealer who operates more than one (1) Scrap Salvage Yard within the City shall be required to have in effect a separate license for each Scrap Salvage Yard.

3. Other Licenses And Permits. A license issued hereunder shall not exempt the holder thereof from obtaining such other licenses and permits as may be relevant and otherwise required by the City or by any other governmental agency.

4. Compliance With Order Of City Enforcing Departments. It shall be unlawful for any licensee to fail to obey any final order of any enforcing department which was issued under the authority hereof.

5. Compliance With License Requirements. It shall be unlawful for any licensee to perform a licensed activity contrary to the terms of this Ordinance.

6. Exceptions to the Requirements of this Section.

a. Returnable Glass Bottles. No Scrap Salvage Collector or Scrap Salvage Dealer License is required for the collection of returnable glass bottles for the purpose of the refilling thereof, when they are stored in a wholly enclosed building or structure.

b. Aluminum Cans. No Scrap Salvage Collector or Scrap Salvage Dealer License is required hereunder for the collection of aluminum cans for the purpose of recycling thereof, as authorized by the Zoning Ordinance, where they are stored in a wholly enclosed building or structure.

c. City Licensed Towers. No Scrap Salvage Collector or Scrap Salvage Dealer License is required for a Tower licensed under §13.12 of the Code of General Ordinances while engaged in a licensed activity thereunder.

CODE OF GENERAL ORDINANCES, 2021 - KENOSHA, WISCONSIN

d. Nonprofit And Charitable Entities. Nonprofit and charitable entities and persons acting on behalf thereof need not obtain a license hereunder where old newspapers, cardboard, aluminum cans or returnable glass bottles are collected solely for the purpose of fund raising and sold directly to a Scrap Salvage Dealer or Scrap Salvage Collector, and where such activity is conducted for no more than thirty (30) days, individually or consecutively, within any calendar year, and where Scrap Salvage is stored within a building or enclosed structure, and secured so as not to become litter.

It shall be unlawful for any unlicensed nonprofit or charitable entities or persons acting on behalf thereof to act in the capacity of a Scrap Salvage Dealer or Scrap Salvage Collector, except within the limitations above provided.

e. City. The City of Kenosha is excluded from the licensing requirements hereof.

D. Enforcement. The Director of the Department of City Development, Department of City Inspections, or designee thereof, and the Police Chief, or designee thereof, shall share the responsibility to enforce this Ordinance.

Citizens may file complaints with any Department having enforcement powers. It shall be the duty of each Department to investigate complaints when the Department has enforcement authority. Further, it shall be the duty of any Department receiving a complaint which is not within their jurisdiction to take the complaint and refer it to the Department having proper jurisdiction. After normal City Municipal Building working hours, all complaints shall be made to the Police Department, who, where the complaint is outside of its jurisdiction, shall take the complaint and refer it to the Department having proper jurisdiction.

The Director of the Department of City Development, Department of City Inspections, or designee thereof, and the Police Chief, or designee thereof, shall share the responsibility of investigating complaints and/or activities to the effect that some person is engaged in an activity requiring a license hereunder without first having obtained said license.

This Ordinance shall be enforced by the following City Departments (enforcing departments) as follows:

1. By the Director of the Department of City Development, Department of City Inspections or designee thereof, with respect to the Building (Chapter IX), Sign (Chapter XV) and Property Maintenance (Chapter XVI) Codes, the Zoning Code, and with respect to provisions of this Ordinance regulating fences and height of Scrap Salvage piles.

2. By the Fire Chief, or designee thereof with respect to the Fire (Chapter III) Code and with respect to the provisions of this Ordinance related to Fire Lanes and fire control, fire prevention and fire fighting.

3. By the Police Chief, or designee thereof, with respect to Traffic Regulations (Chapter VII), Good Order and Conduct (Chapter XI) and with respect to the crime prevention and detection provisions of this Ordinance.

4. By the Health Administrator, or designee thereof, with respect to the Health (Chapter IV) and Noise (Chapter XXIII) Codes, and with respect to the health and sanitation provisions of this Ordinance.

E. Inspections.

1. Scrap Salvage Dealers. Applicants and Licensees shall permit authorized representatives of any Department of the City having enforcement powers hereunder to inspect the Licensed Premises, with or without advance notice, as often as may be required to permit said Departments to perform their duties and assure compliance with this Ordinance. Inspections shall be made during normal hours of business operation in the absence of emergency circumstances that require prompt action to protect the public

CODE OF GENERAL ORDINANCES, 2021 - KENOSHA, WISCONSIN

health, safety or welfare or to preserve evidence of noncompliance with this Ordinance. The failure to permit inspections is grounds for license denial, nonrenewal, suspension or revocation.

Applicants and Licensees shall permit authorized representatives of any Department of the City having enforcement powers hereunder to inspect the equipment associated with the operations of the Scrap Salvage Dealer or proposed to be used by an applicant for a Scrap Salvage Dealer license, with or without advance notice, as often as may be required to permit said Departments to perform their duties and assure compliance with this Ordinance.

2. Scrap Salvage Collectors. Applicants and Licensees shall permit authorized representatives of any Department of the City having enforcement powers hereunder to inspect the portions of the Exterior Premises of the residence of the licensee/ applicant to which the licensee/applicant has legal authority to enter, with or without advance notice, as often as may be required to permit said Departments to perform their duties and assure compliance with this Ordinance, without the necessity of the authorized representative first obtaining a special inspection warrant. Inspections shall be made during daylight in the absence of emergency circumstances that require prompt action to protect the public health, safety or welfare or to preserve evidence of noncompliance with this Ordinance. The unreasonable failure to permit inspections is grounds for license denial, nonrenewal, suspension or revocation.

Applicants and Licensees shall permit authorized representatives of any Department of the City having enforcement powers hereunder to inspect the equipment associated with the operations of the Scrap Salvage Collector or proposed to be used by an applicant for a Scrap Salvage Collector license, with or without advance notice, as often as may be required to permit said Departments to perform their duties and assure compliance with this Ordinance.

F. Application. An applicant for a license under this Ordinance shall file with the City Clerk a written application, which is true, correct and complete, signed by himself, if an individual, by all partners if a partnership, and by the president or chief officer of a corporation or other organization, upon forms provided by the City Clerk, together with a fee as hereinafter prescribed. The application shall be sworn to by each of its signers before a notary public or other officer authorized by law to administer oaths and shall include the following information or material:

1. With respect to Scrap Salvage Dealers:

a. Exact address or location of the place where the business is or is proposed to be carried on, plus a sketch of the actual premises to be used in connection with the business, giving distances in feet and showing fire lanes, property lines, buildings, and abutting roads.

b. A description of the type of construction of any building and structure to be used in connection with the licensed business; a sketch showing the location of such buildings or structures on the business premises, with respect to their distance from roads and fire lanes and a diagram or plan giving distances and heights, showing floors, exits, entrances, windows, ventilators, and walls.

c. A description of any equipment or machinery which will be utilized to process Scrap Salvage and a description of motor vehicles which will be used to collect or haul Scrap Salvage in the operation of the licensed business, including their I.D., D.M.V. and L.C. numbers, where applicable.

d. Such other information as is reasonably necessary to effectuate the purposes of this Ordinance and to arrive at a fair determination of whether the terms of this Ordinance have been complied with.

e. Proof of insurance/financial responsibility for all motor vehicles which will be utilized in the operation of the licensed business, in accordance with the requirements of State law.

f. Proof that licensee's name is conspicuously and legibly printed on all motor vehicles to be used in the operation of the licensed business.

CODE OF GENERAL ORDINANCES, 2021 - KENOSHA, WISCONSIN

g. Proof of current registration of all motor vehicles to be used in the course of performing licensed activities.

h. A list of all persons who will operate motor vehicles in the course of performing licensed activities and proof of their possessing a valid and appropriate Wisconsin Driver's License.

2. With respect to Scrap Salvage Collectors:

a. A photograph of all persons required to sign the application, taken within sixty (60) days immediately prior to the date of the filing of the application, which shall be at least 2" by 2", showing their head and shoulders in a clear and distinguishing manner.

b. A description of motor vehicles which will be used to collect or haul Scrap Salvage in the operation of the licensed business, including I.D., M.V.D. and L.C. numbers, where applicable.

c. Such other information as is reasonably necessary to effectuate the purposes of this Ordinance and to arrive at a fair determination of whether the terms of this Ordinance have been complied with.

d. Proof of insurance/financial responsibility for all motor vehicles which will be utilized in the operation of the licensed business, in accordance with the requirements of State law.

e. Proof that licensee's name is conspicuously and legibly printed on all motor vehicles to be used in the operation of the licensed business.

f. Proof of current registration of all motor vehicles to be used in the course of performing licensed activities.

g. A list of all persons who will operate motor vehicles in the course of performing licensed activities and proof of their possessing a valid and appropriate Wisconsin Driver's License.

h. The address of the residence of the applicant.

G. Recommendation. Upon receipt of any application, the City Clerk shall send copies thereof to the Department of City Development, Department of City Inspections, Fire Department, Health Department and Police Department. The Department of City Development, Department of City Inspections, Fire Department and Health Department, either jointly or severally, within ten (10) days of receiving such copies, shall make a report, in writing, as to whether the premises meet the requirements hereof, along with any other pertinent information. The Police Department shall report in writing, to the City Attorney, as to any police record of applicant which may reflect upon their good moral character or business responsibility. The City Attorney shall examine said record and make a recommendation based thereon as to whether or not the license should be granted. Such reports shall be delivered to the City Clerk or clerk for the Committee on Licensing who, in turn, shall deliver them with the application, to the Committee on Licensing. Such Committee shall recommend to the Common Council either the granting or denial of the application or such other action as may be appropriate.

H. License.

1. Form. The Scrap Salvage Dealer's License as issued, shall bear the following language on its face: "IMPORTANT - This license applies only to the described premises approved by the Common Council and authorizes the Licensee to operate a Scrap Salvage Yard in a lawful place and manner only; it is not a substitute for any Certificate of Occupancy, Building Permit, Conditional Use Permit or other licenses, certificates, or permits that might be required by law of the Licensee, and it does not relieve the Licensee of the responsibility of having all such required licenses, permits or certificates at all times and complying with all other laws, rules and regulations affecting the business premises".

CODE OF GENERAL ORDINANCES, 2021 - KENOSHA, WISCONSIN

2. Fee

- a. Scrap Salvage Dealer: \$350
- b. Scrap Salvage Collector: \$75

3. Term.

- a. Scrap Salvage Dealer: May 1 through April 30.
- b. Scrap Salvage Collector: May 1 through April 30.

4. Renewal. License renewal applications shall be the same as new license applications, except that Licensee's report of police record need only be updated, and except that renewal applications must be filed with the City Clerk by March 15th in order to provide for continuous licensing.

5. Transfer/Assignment. Licenses are not transferable or assignable, and may not be utilized and approved by the Common Council.

I. Amendment/Correction. Applicants and Licensees shall have the duty to amend and correct their application within ten (10) days of such time as any information stated therein is known by Applicant/Licensee to be untrue, incorrect or incomplete. However, no material change in personnel, scope of operation, or site of operation shall be effective without the advance approval thereof by the Common Council based upon a specific request for such approval.

K. General Operating Requirements.

1. Scrap Salvage Dealers. The following general operating requirements shall apply to all Scrap Salvage Dealers licensed in accordance with the provisions of this Ordinance:

- a. The license issued pursuant to this Ordinance shall be plainly displayed on the business premises.
- b. The Scrap Salvage Yard shall, at all times be maintained in as clean, sanitary and neat of a condition as such premises will reasonably permit.
- c. An area which is not described in the approved license application shall not be used in the conduct of licensed business.
- d. No water shall be allowed to stand on the premises in such manner as to, in the opinion of the Health Administrator, constitutes a breeding place for insects or disease which may endanger health.
- e. Grass and other ground cover on the premises shall be kept at a height of not more than eight (8) inches. The premises shall be substantially free of noxious weeds.
- f. No garbage, refuse or other waste liable to give off a foul odor or attract vermin shall be kept on the premises, except for domestic garbage which shall be kept in containers which are, in the opinion of the Health Administrator, rodentproof, and removed from the premises as often as is necessary to provide a sanitary environment, but at no less an interval than on a weekly basis.
- g. No Scrap Salvage which is stored on the premises shall be allowed to rest upon or protrude over any public street, walkway, or curb or become scattered about or blown off the premises.
- h. Scrap Salvage on the premises, which is not stored in racks or containers, shall be stored in piles not exceeding thirty (30) feet in height, at an angle of forty (40°) degrees or less from the ground, and shall be arranged so as to permit access to all such Scrap Salvage for firefighting purposes. Scrap Salvage which is stored in racks or containers shall not be stored at a height in excess of twenty-five (25) feet.

CODE OF GENERAL ORDINANCES, 2021 - KENOSHA, WISCONSIN

i. No combustible material of any kind not necessary for the operation of the licensed business, whether within or without a building or structure, shall be kept on the premises, except with the written permission of the Fire Department. The premises shall not be allowed to become a fire hazard.

j. Scrap Salvage may not be broken into smaller pieces on the premises through the use of a ball or object dropped from a crane or apparatus, without Licensee first obtaining a permit therefor from the Common Council which may be granted and issued only upon a showing by Licensee that such activity will be conducted in a manner which is safe and lawful and which will not injure the public health, safety or welfare. Licensee may be requested, as part of the application process, to conduct or arrange for a demonstration, on site if possible, of the acts which are subject to this permit requirement before the Director of City Inspections or other designee of the Common Council who may make appropriate observations and cause noise, vibration and other tests to be conducted. The Common Council may place reasonable restrictions on the permitted activity, regulating the time, place and manner of operation.

k. Licensee shall not directly or indirectly purchase Scrap Salvage from any person that they know, or should know, cannot rightfully or lawfully sell it or deliver clear title thereto.

m. No process shall be utilized to reduce Scrap Salvage in size which causes vibrations which may damage the property of another or which may be injurious to the public health, safety and welfare. Complaints in this regard shall be processed by the Health Department, which may issue abatement orders, following notice and an opportunity to be heard.

n. **Chapter XXIII** of the Code of General Ordinances, Noise Control, shall be strictly complied with.

o. The Exterior Premises of the Licensed Premises whereupon Scrap Salvage is stored shall be enclosed with a solid, vertical wall or fence of a minimum height of six (6) feet measured from ground level, except where Scrap Salvage is shielded from view by an earthen berm of a minimum height of six (6) feet in which event the required fence need not shield Scrap Salvage from view. Entrances and exits shall not be wider or more numerous than reasonably necessary for the conduct of the licensed business. Fences must be sturdily constructed, safe vertical straight, well maintained and must shield Scrap Salvage from view. Fences must be protected with paint or other preservatives. Fences must not create an appearance of patchwork which is indicative of a state of disrepair. Fences shall be of uniform color which will not detract from the value of abutting and neighboring real estate. No signs may be painted on or attached to any fence, except for a sign of not more than eight (8) square feet, located at an entranceway thereto which provides the name of the business. Fences must be constructed in such a fashion and of such materials and color as are approved by the Director of City Inspections prior to fence construction, repair or replacement. Chainlink fencing shall be appropriate where opaque strips are inserted in the fence. No fence may be constructed or replaced without the approval of the Director of City Inspections, or designee thereof, which approval may be denied if the above standards have not been complied with or if the construction of a proposed new fence or replacement fence would violate any other provision of law. No Scrap Salvage may be stored outside of said fence or may be stored so as to rest against said fence, protrude through it, or hang over it. Fence gates shall be kept closed when not required to be open for ingress or egress, except where a buffer fence is constructed in the vicinity of fence gates within the Scrap Salvage Yard which shields Scrap Salvage from view when the gates are open. In all other respects, fences shall be installed and constructed in accordance with City Ordinances.

p. No Scrap Salvage Dealer licensed hereunder or his agent or employee shall, except for aluminum cans, purchase or receive any Scrap Salvage for use in the licensed business from any person under the age of eighteen (18) years without the written consent of a parent or guardian of such person. Such writing shall be held available for inspection by any member, or representative, of the Police Department for one (1) year.

q. Each acquisition of such Scrap Salvage as is capable of being used for its original and intended purpose without repair or alteration, including all motor vehicle parts, except for bulk purchases from industrial and commercial concerns, shall be recorded in English in a permanent type register kept on the business premises, giving the name and residence address of the person from whom the acquisition was

CODE OF GENERAL ORDINANCES, 2021 - KENOSHA, WISCONSIN

made, a description of the Scrap Salvage acquired, any identification or serial number, and the date of the transaction. Such data shall be held available for inspection by any member, or representative, of the Police Department for one (1) year. The identification of each seller of a motor vehicle or motor vehicle part shall be checked and the type of identification checked noted, except where the purchase is from a licensed motor vehicle dealer, an insurance company, a City licensed tower or an auction.

r. No Scrap Salvage Yard shall be allowed to become a public or attractive nuisance; nor shall any Scrap Salvage Yard be operated in such manner as to adversely affect the public health, safety, or welfare.

s. There shall be full compliance with the City Building, Fire and Health Codes and with all other City, County, State and Federal laws, rules or regulations which may be applicable.

t. The Fire Department may order Licensees to install fire lanes, following notice and opportunity to be heard, and upon providing a reasonable time for compliance.

u. The terms of a Conditional Use Permit which are not inconsistent with this Ordinance, shall be complied with at all times as a condition of license maintenance.

v. No Scrap Salvage shall be collected which is placed on a City right-of-way for City collection and no Scrap Salvage shall be deposited or sorted on a City right-of-way or removed from the property of any nonconsenting person or party.

w. The licensed premises must possess appropriate zoning for the licensed business or constitute a lawful nonconforming use.

x. Motor vehicles which are used in the licensed business shall hold and display an L.C. and M.V.D. number where such number is required by State law, rule or regulation, shall be insured or financially responsible in accordance with State law, shall be properly and currently registered with the State Motor Vehicle Department, and shall have the licensee's name conspicuously and legibly printed thereon.

2. Scrap Salvage Collectors. The following general operating requirements shall apply to all Scrap Salvage Collectors licensed in accordance with this Ordinance:

a. Licensees shall have the license issued to them under this Ordinance in their immediate possession at all times when acting as a Scrap Salvage Collector in the City and shall exhibit it to any person upon request.

b. Licensee, except for aluminum cans, shall not purchase or receive any Scrap Salvage from any person under the age of eighteen (18) years without the written consent of a parent or guardian of such person. Licensee shall retain such writing for a period of at least one (1) year, and shall produce it within a reasonable time upon the request of any member, or representative of a member of the Police Department.

c. Licensee shall record in English, in a permanent type register, each acquisition of such Scrap Salvage as is capable of being used for its original and intended purpose, including all motor vehicle parts, except for bulk purchases from industrial and commercial concerns, within the City, giving the name and residence address of the person from whom the acquisition was made, a description of the Scrap Salvage acquired, any identification or serial number, and the date of the transaction. Licensee shall retain such data for a period of at least one (1) year, and shall produce them within a reasonable time upon the request of any member or representative of the Police Department. The identification of each seller of a motor vehicle or motor vehicle part shall be checked, and the type of identification checked, noted, except where the purchase is from a licensed motor vehicle dealer, an insurance company, a City licensed tower or an auction.

d. Licensee shall not directly or indirectly purchase Scrap Salvage from any person that they know, or should know, cannot rightfully or lawfully sell it or deliver clear title thereto.

CODE OF GENERAL ORDINANCES, 2021 - KENOSHA, WISCONSIN

e. No Scrap Salvage shall be collected which is placed on a City right-of-way for City collection and no Scrap Salvage shall be deposited or sorted on a City right-of-way or removed from the property of any nonconsenting person or party.

f. Motor vehicles which are used in the licensed business shall hold and display an L.C. and M.V.D. number where such number is required by State law rule or regulation, shall be insured or financially responsible in accordance with State law, shall be properly and currently registered with the State Motor Vehicle Department, and shall have the licensee's name conspicuously and legibly printed thereon.

g. Scrap Salvage Collectors must notify the City Clerk in writing of any changes to the residence of the licensee or the equipment being used by the licensee, as soon as practicable.

L. Licensees/Responsibility. Scrap Salvage Dealers and Scrap Salvage Collectors shall, with respect to the conduct of their business, have a duty to supervise their agents and employees and shall be responsible for the acts thereof.

M. Suspected Stolen and Evidentiary Scrap Salvage. The Police Department may order any licensee hereunder to retain any Scrap Salvage which is suspected to be stolen, for a period not to exceed thirty (30) days pending an investigation. The Police Department, at any time, may seize as evidence, any Scrap Salvage that they have probable cause to believe is stolen. Any enforcing department may order a Licensee to retain Scrap Salvage upon the premises which is suspected of being held in violation of this Ordinance for a period not to exceed thirty (30) days during which an investigation can be conducted. Any enforcing department may take samples of Scrap Salvage for purposes of testing or arrange for any other governmental agency to do so.

N. Conditional Use Permits. Conditional Use Permits, as required by the Zoning Ordinance, shall be required prior to any unlicensed premises being licensed and prior to the expansion of any existing licensed premises, and each license shall be conditioned upon obtaining and complying with the provisions of a Conditional Use Permit, where required. A Conditional Use Permit may contain requirements over and above the requirements of this Ordinance, but may not negate any of the requirements of this Ordinance, and if it would do so, any conflicting provisions thereof shall be null and void.

O. Appeals From Orders. A Licensee, where the public health, safety and welfare is not in immediate jeopardy, may appeal to the Common Council any order issued by any enforcing Department under authority of this Ordinance by filing a written Notice of Appeal with said Department within ten (10) days of receipt of said order, or within the compliance period, whichever is shorter. The Common Council may direct that the appeal be heard by a Committee thereof.

P. Revocation and Suspension Of Licenses. The Common Council may, for just cause, suspend, revoke or not renew any license herein provided, upon serving such party written notice of the charges forming a basis for the proposed penalty, in the same manner as that for the service of a Summons in a civil action. Just cause shall include, but not be limited to:

1. Failing to maintain a status of good moral character and business responsibility.
2. Obtaining the license through fraud or misrepresentation.
3. Operating contrary to the terms of this Ordinance.
4. Failing to commence doing business within ninety (90) days of being granted a license or within ninety (90) days of the first day of the license term, whichever is longer, unless an extension of time is applied for and granted by the Licensing/Permit Committee.
5. Suspending doing business for a period of ninety (90) consecutive days, unless permission is

CODE OF GENERAL ORDINANCES, 2021 - KENOSHA, WISCONSIN

applied for and granted by the Licensing/Permit Committee.

Q. Disciplinary Hearings. Disciplinary hearings, including nonrenewal, suspension and revocation hearings, may be held before the Common Council or before the Committee charged with license review responsibilities.

The Committee on Licensing, when it conducts a hearing, shall submit a report to the City Common Council, including findings of fact, conclusions of law and a recommendation as to what action, if any, the City Common Council should take with respect to the license. Said Committee shall provide the complainant and the licensee with a copy of the report. Either the complainant or Licensee may file an objection to the report and shall have the opportunity to present arguments supporting the objection to the Common Council. The City Common Council shall determine whether the arguments shall be presented orally or in writing, or both. If the City Common Council, after considering the Committee's report and any arguments presented by complainant or Licensee, finds the complaint to be true, or if there is no objection to a report recommending a suspension, revocation or nonrenewal of the license, it shall be suspended, revoked or not renewed as provided by law. If the City Common Council finds the complaint untrue, the proceedings shall be dismissed without cost to the accused. The City Clerk shall give notice of each suspension, revocation or nonrenewal to the party whose license is affected. The Common Council may also order corrective action to be taken within a specified time as a condition of license maintenance, at any time, following notice and an opportunity to be heard.

R. Penalty. Any person who shall violate any of the terms and conditions of this Ordinance shall, upon conviction thereof, forfeit not more than Five Hundred (\$500) Dollars, plus the costs of prosecution, and in default of the timely payment thereof be confined in the County Jail for a period not to exceed (30) days.

S. Violations. Each day of a violation of this Ordinance shall be considered a separate offense.

13.011 RECYCLING CENTER ACTIVITY LICENSE

A. Definitions

1. Hazardous Waste: has the meaning of the term used in 40 CFR §261.3 unless excluded in §261.4.
2. Person: person, firm, partnership, association, corporation, company, or organization of any kind.
3. Recycling Center: Place upon which Recycling Center Activity conducted by a Licensee under this section takes place.
4. Recycling Center Activity: The commercial collecting of Recycling-Center Material, storing of Recycling-Center-Material, or engaging in Recycling-Center-Material Processing.
5. Recycling-Center Material: Recycling-Center Metals, batteries, catalytic converters, electronic scrap or stainless steel.
6. Recycling-Center-Material Processing: The crushing of metal items or the reduction of the volume of metal items by shredding, chipping, melting, or any other means.
7. Recycling-Center Metal: Aluminum, copper, tin, and all alloys of aluminum, copper, or tin provided that said alloys do not include gold, silver, platinum, palladium, iridium, rhodium, ruthenium, iron, arsenic, mercury, lead, cadmium, antimony, barium, beryllium, osmium, thallium, vanadium, chromium (IV), or radioactive metals.
8. Recycling-Center Yard: The exterior portions of any building associated with a Recycling Center Activity where Recycling-Center Materials are stored.

CODE OF GENERAL ORDINANCES, 2021 - KENOSHA, WISCONSIN

B. License Required

1. Licenses. It shall be unlawful for any person to conduct Recycling Center Activity within the City, whether personally, by agents or employees, singly, or along with some other business or enterprises without first having obtained a license therefor from the Common Council in accordance with the provisions of this ordinance.

2. Other Licenses and Permits. A license issued hereunder shall not exempt the holder thereof from obtaining such other licenses and permits as may otherwise be required by the City or by any other governmental agency.

C. Application. An applicant for a license under this Ordinance shall file with the City Clerk a written application, which is true, correct and complete, signed by himself, if an individual, by all partners if a partnership, and by the president or chief officer of a corporation or other organization, upon forms provided by the City Clerk, together with a fee as hereinafter prescribed. The application shall be sworn to by each of its signers before a notary public or other officer authorized by law to administer oaths and shall include the following information or material:

a. Exact address or location of the place where the business is or is proposed to be carried on, plus a sketch of the actual premises to be used in connection with the business, giving distances in feet and showing fire lanes, property lines, buildings, and abutting roads, particularly identifying the Recycling-Center Yard.

b. A description of the type of construction of any building and structure to be used in connection with the licensed business; a sketch showing the location of such buildings or structures on the business premises, with respect to their distance from roads and fire lanes and a diagram or plan giving distances and heights, showing floors, exits, entrances, windows, ventilators, and walls.

c. A description of any equipment or machinery which will be utilized to process Recycling Center Material and a description of motor vehicles which will be used to collect or haul Recycling Center Material in the operation of the licensed business, including their Vehicle Identification Number, and any D.M.V. or L.C. numbers, where applicable.

d. Such other information as is reasonably necessary to effectuate the purposes of this Ordinance and to arrive at a fair determination of whether the terms of this Ordinance have been complied with.

e. Proof of insurance/financial responsibility for all motor vehicles which will be utilized in the operation of the licensed business, in accordance with the requirements of State law.

f. Proof of current registration of all motor vehicles to be used in the course of performing licensed activities.

g. A list of all persons who will operate motor vehicles in the course of performing licensed activities and proof of their possessing a valid and appropriate Wisconsin Driver's License.

D. Application Review. Upon receipt of any application, the City Clerk shall send copies thereof to the Department of City Development, Department of City Inspections, Fire Department, Health Department and Police Department. The Department of City Development, Department of City Inspections, Fire Department and Health Department, either jointly or severally, within ten (10) days of receiving such copies, shall make a report, in writing, as to whether the premises meet the requirements hereof, along with any other pertinent information. The Police Department shall report in writing, to the City Attorney, as to any police record of applicant which may reflect upon their good moral character or business responsibility. The City Attorney shall examine said record and make a recommendation based thereon as to whether or not the license should be granted. Such reports shall be delivered to the City Clerk or clerk for the Committee on Licensing who, in turn, shall deliver them with the application, to the

CODE OF GENERAL ORDINANCES, 2021 - KENOSHA, WISCONSIN

Committee on Licensing. Such Committee shall recommend to the Common council either the granting or denial of the application or such other action as may be appropriate.

E. Fee. The annual fee for a Recycling Center Activity license is \$350, which shall not be pro-rated.

F. License Form. The Recycling Center Activity license shall bear the following language on its face: "IMPORTANT - This license applies only to the described premises approved by the Common Council and authorizes the Licensee to operate a Recycling Center Activity in a lawful place and manner only; it is not a substitute for any Certificate of Occupancy, Building Permit, Conditional Use Permit, or other licenses, certificates, or permits that might be required by law of the Licensee, and it does not relieve the Licensee of the responsibility of having all such required licenses, permits, or certificates at all times and of complying with all other laws, rules and regulations affecting the business premises."

G. Term/Renewal.

1. The term for a Recycling Center Activity licensee is one year, from May 1 or the date of first issue through the ensuing April 30.

2. License renewal applications shall be the same as new license applications, except that Licensee's report of police record need only be updated.

3. Renewal applications must be filed with the City Clerk by March 15th in order to provide for continuous licensing.

H. Non-Transferability. Licenses are not transferable or assignable.

I. Corrections. Applicants and Licensees shall have the duty to amend and correct their application within ten (10) days of such time as any information stated therein is known by Applicant/Licensee to be untrue, incorrect or incomplete. No material change in personnel, scope of operation, or site of operation shall be effective without the advance approval thereof by the Common Council based upon a specific request for such approval.

J. Exemption. The following are exempted from the provisions of this section:

1. Fund raising efforts by not-for-profit organizations;
2. Community clean up efforts by not-for-profit organizations;
3. Community clean up efforts conducted under the auspices of state Adopt-a-Highway program;
4. Licensed scrap salvage dealers or licensed scrap salvage collectors when operating within the operational limitations of the respective licenses; and
5. The City.

K. General Operating Requirements.

1. Recycling Center Activity licensees. The following general operating requirements shall apply to all Recycling Center Activity licensees licensed in accordance with the provisions of this Section:

- a. The license issued pursuant to this Section shall be plainly displayed on the business premises.
- b. The Recycling-Center Yard shall, at all times be maintained in as clean, sanitary and neat of a

CODE OF GENERAL ORDINANCES, 2021 - KENOSHA, WISCONSIN

condition as such premises will reasonably permit.

c. An area which is not described in the approved license application shall not be used in the conduct of licensed business.

d. No water shall be allowed to stand on the premises in such manner as to, in the opinion of the Health Administrator, constitutes a breeding place for insects or disease that may endanger health.

e. Grass and other ground cover on the premises shall be kept at a height of not more than eight (8) inches. The premises shall be substantially free of noxious weeds.

f. No garbage, refuse or other waste liable to give off a foul odor or attract vermin shall be kept on the premises, except for domestic garbage which shall be kept in containers which are, in the opinion of the Health Administrator, rodentproof, and removed from the premises as often as is necessary to provide a sanitary environment, but at no less an interval than on a weekly basis.

g. No Recycling Center Material which is stored on the premises shall be allowed to rest upon or protrude over any public street, walkway, or curb or become scattered about or blown off the premises.

h. Recycling Center Material on the premises, which is not stored in racks or containers, shall be stored in piles not exceeding ten feet (10') in height, at an angle of forty degrees (40°) or less from the ground, and shall be arranged so as to permit access to all such Recycling Center Material for firefighting purposes. Recycling Center Material which is stored in racks or containers shall not be stored at a height in excess of ten feet (10').

i. No combustible material of any kind not necessary for the operation of the licensed business, whether within or without a building or structure, shall be kept on the premises, except with the written permission of the Fire Department. The premises shall not be allowed to become a fire hazard.

j. Recycling Center Material may not be reduced in volume on the premises through the use of a any apparatus, without Licensee first obtaining a permission therefor from the Common Council which may be granted and issued only upon a showing by Licensee that such activity will be conducted in a manner which is safe and lawful and which will not injure the public health, safety or welfare. Licensee may be requested, as part of the application process, to conduct or arrange for a demonstration, on site if possible, of the acts which are subject to this permit requirement before the Director of City Inspections or other designee of the Common Council who may make appropriate observations and cause noise, vibration and other tests to be conducted. The Common Council may place reasonable restrictions on the permitted volume-reducing activity, regulating the time, place and manner of operation.

k. Licensee may not store or process any elemental metal or alloy of metal on a Recycling Center, unless it is a Recycling-center material.

l. Even if volume-reducing apparatus has been otherwise permitted by the Common Council, no process shall be utilized to reduce the volume of Recycling Center Material in a manner that causes vibrations which may damage the property of another or which may be injurious to the public health, safety and welfare. Complaints in this regard shall be processed by the Health Department, which may issue abatement orders, following notice and an opportunity to be heard.

m. Licensee shall not directly or indirectly purchase Recycling Center Material from any person that they know, or should know, cannot rightfully or lawfully sell it or deliver clear title thereto.

n. Chapter XXIII of the Code of General Ordinances, "Noise Control", shall be strictly complied with.

o. The open area of the premises whereupon Recycling Center Material is stored shall be enclosed

CODE OF GENERAL ORDINANCES, 2021 - KENOSHA, WISCONSIN

with a solid, vertical wall or fence of a minimum height of six feet (6') measured from ground level, except where Recycling Center Material is shielded from view by an earthen berm of a minimum height of six feet (6') in which event the required fence need not shield Recycling Center Material from view. Entrances and exits shall not be wider or more numerous than reasonably necessary for the conduct of the licensed business. Fences must be sturdily constructed, safe vertical straight, well maintained and must shield Recycling Center Material from view. Fences must be protected with paint or other preservatives. Fences must not create an appearance of patchwork which is indicative of a state of disrepair. Fences shall be of uniform color which will not detract from the value of abutting and neighboring real estate. No signs may be painted on or attached to any fence, except for a sign of not more than eight square feet (8 ft²), located at an entranceway thereto which provides the name of the business. Fences must be constructed in such a fashion and of such materials and color as are approved by the Director of City Inspections prior to fence construction, repair or replacement. Chain link fencing shall be appropriate where opaque strips are inserted in the fence. No fence may be constructed or replaced without the approval of the Director of City Inspections, or designee thereof, which approval may be denied if the above standards have not been complied with or if the construction of a proposed new fence or replacement fence would violate any other provision of law. No Recycling Center Material may be stored outside of said fence or may be stored so as to rest against said fence, protrude through it, or hang over it. Fence gates shall be kept closed when not required to be open for ingress or egress, except where a buffer fence is constructed in the vicinity of fence gates within the Recycling-Center Yard which shields Recycling Center Material from view when the gates are open. In all other respects, fences shall be installed and constructed in accordance with City Ordinances.

p. No Recycling Center Activity licensee or his or her agent or employee shall, except for aluminum cans, purchase or receive any Recycling Center Material for use in the licensed business from any person under the age of eighteen (18) years without the written consent of a parent or guardian of such person. Such writing shall be held available for inspection by any member, or representative, of the Police Department for one (1) year.

q. Each acquisition of such Recycling Center Material as is capable of being used for its original and intended purpose without repair or alteration, including all motor vehicle parts, except for bulk purchases from industrial and commercial concerns, shall be recorded in English in a permanent type register kept on the business premises, giving the name and residence address of the person from whom the acquisition was made, a description of the Recycling Center Material acquired, any identification or serial number, and the date of the transaction. Such data shall be held available for inspection by any member, or representative, of the Police Department for one (1) year. The identification of each seller of a motor vehicle or motor vehicle part shall be checked and the type of identification checked noted, except where the purchase is from a licensed motor vehicle dealer, an insurance company, a City licensed tower or an auction.

r. No Recycling-Center Yard shall be allowed to become a public or attractive nuisance; nor shall any Recycling-Center Yard be operated in such manner as to adversely affect the public health, safety, or welfare.

s. There shall be full compliance with the City Building, Fire, and Health Codes and with all other City, County, State and Federal laws, rules or regulations which may be applicable.

t. The Fire Department may order Licensees to install fire lanes, following notice and opportunity to be heard, and upon providing a reasonable time for compliance.

u. The terms of a Conditional Use Permit which are not inconsistent with this Ordinance, shall be complied with at all times as a condition of license maintenance.

v. No Recycling Center Material shall be collected which is placed on a City right-of-way for City collection and no Recycling Center Material shall be deposited or sorted on a City right-of-way or removed from the property of any nonconsenting person or party.

CODE OF GENERAL ORDINANCES, 2021 - KENOSHA, WISCONSIN

w. The licensed premises must possess appropriate zoning for the licensed business or constitute a lawful nonconforming use.

x. Motor vehicles which are used in the licensed business shall hold and display an L.C. and M.V.D. number where such number is required by State law, rule or regulation, shall be insured or financially responsible in accordance with State law, shall be properly and currently registered with the State Motor Vehicle Department, and shall have the licensee's name conspicuously and legibly printed thereon.

y. Hazardous Waste may not be collected, stored, or processed on the business premises.

L. Licensees/Responsibility. Recycling Center Activity licensees shall, with respect to the conduct of their business, have a duty to supervise their agents and employees and shall be responsible for the acts thereof.

M. Suspected Stolen and Evidentiary Recycling Center Material. The Police Department may order any licensee hereunder to retain any Recycling Center Material upon the premises which is suspected to be stolen for a period not to exceed thirty (30) days pending an investigation. The Police Department, at any time, may seize from the premises, as evidence, any Recycling Center Material which they have probable cause to believe is stolen, and may hold said Recycling Center Material for so long as it shall have evidentiary value. Any seized item shall be released within a reasonable time upon prosecution being denied by any prosecuting attorney. Any enforcing department may order a Licensee to retain Recycling Center Material upon the premises which is suspected of being held in violation of this Ordinance for a period not to exceed thirty (30) days during which an investigation can be conducted. Any enforcing department may take samples of Recycling Center Material for purposes of testing or arrange for any other governmental agency to do so.

N. Conditional Use Permits. Conditional Use Permits, as required by the Zoning Ordinance, shall be required prior to any unlicensed premises being licensed and prior to the expansion of any existing licensed premises, and each license shall be conditioned upon obtaining and complying with the provisions of a Conditional Use Permit, where required. A Conditional Use Permit may contain requirements over and above the requirements of this Ordinance, but may not negate any of the requirements of this Ordinance, and if it would do so, any conflicting provisions thereof shall be null and void.

O. Appeals From Orders. A Licensee, where the public health, safety and welfare is not in immediate jeopardy, may appeal to the Common Council any order issued by any enforcing Department under authority of this Ordinance by filing a written Notice of Appeal with said Department within ten (10) days of receipt of said order, or within the compliance period, whichever is shorter. The Common Council may direct that the appeal be heard by a Committee thereof.

P. Revocation and Suspension Of Licenses. The Common Council may, for just cause, suspend, revoke or not renew any license herein provided, upon serving such party written notice of the charges forming a basis for the proposed penalty, in the same manner as that for the service of a Summons in a civil action. Just cause shall include, but not be limited to:

1. Failing to maintain a status of good moral character and business responsibility.
2. Obtaining the license through fraud or misrepresentation.
3. Operating contrary to the terms of this Ordinance.
4. Failing to commence doing business within ninety (90) days of being granted a license or within ninety (90) days of the first day of the license term, whichever is longer, unless an extension of time is applied for and granted by the Committee on Licenses and Permits.

CODE OF GENERAL ORDINANCES, 2021 - KENOSHA, WISCONSIN

5. Suspending doing business for a period of ninety (90) consecutive days, unless permission is applied for and granted by the Committee on Licenses and Permits.

Q. Disciplinary Hearings. Disciplinary hearings, including nonrenewal, suspension and revocation hearings, may be held before the Common Council or before the Committee charged with license review responsibilities.

The Committee on Licenses and Permits, when it conducts a hearing, shall submit a report to the City Common Council, including findings of fact, conclusions of law and a recommendation as to what action, if any, the City Common Council should take with respect to the license. Said Committee shall provide the complainant and the licensee with a copy of the report. Either the complainant or Licensee may file an objection to the report and shall have the opportunity to present arguments supporting the objection to the Common Council. The City Common Council shall determine whether the arguments shall be presented orally or in writing, or both. If the City Common Council, after considering the Committee's report and any arguments presented by complainant or Licensee, finds the complaint to be true, or if there is no objection to a report recommending a suspension, revocation or nonrenewal of the license, it shall be suspended, revoked or not renewed as provided by law. If the City Common Council finds the complaint untrue, the proceedings shall be dismissed without cost to the accused. The City Clerk shall give notice of each suspension, revocation or nonrenewal to the party whose license is affected. The Common Council may also order corrective action to be taken within a specified time as a condition of license maintenance, at any time, following notice and an opportunity to be heard.

R. Penalty. Any person who shall violate any of the terms and conditions of this Ordinance shall, upon conviction thereof, forfeit not more than Five Hundred (\$500) Dollars, plus the costs of prosecution, and in default of the timely payment thereof be confined in the County Jail for a period not to exceed (30) days.

S. Violations. Each day of a violation of this Ordinance shall be considered a separate offense.

13.0112 NON-STRUCTURAL DEMOLITION

A. Definitions.

Code Official. The Director of Department of City Inspections or his/her designee.

Salvage. To remove salvageable material from a vacated building for other than personal re-use by the owner of the real estate from which it was removed, without immediate functional replacement thereof. The phrase "immediate functional replacement thereof" includes without limitation functional replacement that occurs as a part of a remodeling process over time pursuant to a valid and subsisting building permit.

Salvageable Material. Real or tangible personal property that:

1. was man-made;
2. was affixed with respect to real property;
3. is detachable from real property; and
4. has a resale value, either for re-use or as scrap.

Vacated Building. A building or structure having occupiable space of over fifty thousand square feet (50,000 sq. ft.) that had a principal industrial use as its most recent use allowed by law, which principal industrial use has ceased.

B. Permit. No person may salvage from a Vacated Building unless pursuant to a permit therefor granted by the Common Council and issued to the applicant.

CODE OF GENERAL ORDINANCES, 2021 - KENOSHA, WISCONSIN

C. Permit Application.

1. The applicant may be the owner of the real estate, or the Contractor hired by the owner. Under all circumstances, the applicant, if other than the owner, and the owner, shall be jointly and severally responsible for compliance with the terms of this Ordinance.

2. **Form.** Application for a permit, whether initial or renewal, shall be filed with the City Clerk on forms created by the Code Official and provided by the City. The application for a permit shall at a minimum comply with Section 9.05 of the Code of General Ordinances for the City of Kenosha. The Code Official may require additional information of a specific applicant.

3. **Fees.** A permit fee must accompany the application. Permit fees shall be established by the Kenosha Common Council by resolution.

D. Permit Grant.

The Common Council may consider the permit application only after receiving the recommendation of the Public Safety and Welfare Committee.

Prior to making its recommendation to grant or deny the application, the Public Safety and Welfare Committee shall consider: the application; the report, if any, of the Code Official; the expertise of the applicant; the effect of the proposed operation on the surrounding neighborhood; the effect on the City of having a stripped structure remain if the structure is not proposed to be immediately razed or immediately renovated; the presentation, if any, of the applicant; the comments of the public; and such other matters germane to the decision.

In making a recommendation to grant, the Public Safety and Welfare Committee shall address the following matters: the amount of the Irrevocable Letter of Credit to be required by the Common Council of the permittee as a condition of issuance of the permit and as a requirement of operation; other State or local permits as required by law, rule, or regulation that must be obtained as a condition of issuance of the permit or as a condition of operation; reasonable special operating requirements to be required of the permittee in addition to those listed in subsection D, herein; and such other matters or limitations as the Public Safety and Welfare Committee determines is necessary to protect the public interest.

After grant and after all conditions of issuance have been satisfied, the Code Official shall issue the permit to the applicant, who may then be referred to herein as permittee or permit holder.

E. Irrevocable Letter of Credit.

As a condition of issuance by the City Clerk of the permit, the permittee shall post a Irrevocable Letter of Credit with the City in an amount required by the Common Council and in a form approved by the City Attorney. The Irrevocable Letter of Credit shall guarantee of performance by permittee. The Irrevocable Letter of Credit must be issued by a financial institution certified by the state to conduct such business within the state of Wisconsin, allowing for direct draw by the City on demand without court action and without approval by permittee, to complete work or to repair damage that was the obligation of the permittee. The Irrevocable Letter of Credit must contain as a part of its provisions that it remains as an obligation to the City for no less than one year after completion of the last act by permittee of salvage or after the expiration of a permit issued under this section to the permittee, whichever is later. In considering the amount of the Irrevocable Letter of Credit, the Common Council shall consider: the recommendation, if any, of the Code Official; the expertise of the applicant; the longevity of the applicant; the capitalization of the applicant; the scope of the proposed project; the possible environmental hazards that could be created; the effect of the proposed operation on the surrounding neighborhood; the cost of remediation on the City should the City have to address any matter due to the unwillingness or inability of the permittee to complete its obligations. Under extraordinary circumstances under which the Common Council determines that the requirement to obtain a Letter of Credit is unreasonable, the Common Council may in the exercise of its

CODE OF GENERAL ORDINANCES, 2021 - KENOSHA, WISCONSIN

discretion authorize alternate security

F. Permit Term.

1. Initial term. The initial term for permits issued under this section shall be valid for a period of one hundred eighty (180) days from the date of issue.

2. Renewal term. A permit issued to the applicant is personal to the applicant and limited to the term granted. The permittee may not have an expectation in the renewal of the permit. The permits may be renewed at the discretion of the Common Council upon application of a permit holder, filed with the City Clerk prior to expiration of the initial term or any renewal terms. Each renewal may be granted for up to sixty (60) additional days.

G. General Operating Requirements. The following general operating requirements shall apply to all permittees or those working for permittee subject to terms of the permit in accordance with the provisions of the ordinance.

1. The permit issued pursuant to this ordinance shall be plainly displayed on the premises upon which the building is located.

2. The building and premises shall, at all times be maintained in as clean, neat, and sanitary of a condition as such premises will reasonably permit.

3. No garbage, refuse, or other waste liable to give off a foul odor or attract vermin shall be kept on the premises, except for domestic garbage which shall be kept in containers which are, in the opinion of the Code Official or the Health Administrator, rodent-proof, and removed from the premises as often as is necessary to provide a sanitary environment.

4. Work done under this permit is subject to inspection by the Code Official.

5. Permittees shall have the responsibility to maintain proof of insurance policies in the following minimum amounts, naming the City as an additional insured for all entities or natural persons doing work on the property or associated with the work under the permit:

a. Commercial General Liability:

- 1.** General Aggregate:
One Million Dollars (\$1,000,000);
- 2.** Each Occurrence:
One Million Dollars (\$1,000,000.00).

b. Automobile Liability (Owned, non-owned, leased)

- 1.** Bodily Injury:
One Million Dollars (\$1,000,000) each occurrence
- 2.** Property Damage:
One Million Dollars (\$1,000,000) each occurrence.

c. Pollution Legal Liability:

\$5,000,000.00 each loss where asbestos removal, environmental process, abatement, remediation, or dumping/disposal in a Federal or State regulated facility is required; the Common Council may require a greater or lesser minimum amount down to and including zero (0) of Pollution Legal Liability insurance policy, depending on the circumstances of the project that is the subject of the permit.

d. Workers" Compensation: Statutory Limits

CODE OF GENERAL ORDINANCES, 2021 - KENOSHA, WISCONSIN

e. Umbrella Liability:

\$2,000,000.00 over the primary Commercial General Liability and Automobile Liability insurance coverages listed above.

6. No scrap salvage or debris which is temporarily stored on the premises shall be allowed to rest or protrude over any public street, walkway, or curb or become scattered about or blown off the premises.

7. No mechanized process whatsoever shall be utilized on premises to reduce salvageable material or debris in volume after such salvageable material has been detached from the real property, unless a special exception is provided therefore. Such prohibited mechanized processes include, but are not limited to, crushers or shredders.

8. There shall be strict compliance with Chapter XXII of the Code of General Ordinances, "Noise Control".

9. No premises or building subject to a permit shall be allowed to become a public nuisance or be operated in such a manner as to adversely affect the public health, safety, or welfare.

10. There shall be full compliance with City Building, Fire and Health Codes and with all other City, County, State and Federal laws, rules or regulations which may be applicable.

11. The permit holder shall, during the salvage process, maintain the work site in a safe and secure condition.

12. The permit holder shall dispose of building debris in a licensed landfill, except for salvaged materials. At any time, the permit holder shall produce to the Code Official receipts and/or an itemized list of debris disposed of by dumping or salvage.

13. The permit holder shall be responsible for disconnections of utilities, including plumbing and electrical, necessary for the salvaging process, and shall provide evidence that the necessary disconnections have been accomplished.

14. The Irrevocable Letter of Credit imposed as a condition of issuance of the permit shall be maintained.

15. Permittee shall comply with all orders of the Common Council imposed at the granting of the permit or at any other time.

16. Permittee must provide to the City, and must maintain current, a list of contractors doing work that is subject to a permit issued pursuant to this Section, which list of contractors shall include proof of valid and subsisting policies of insurance in satisfaction of the General Operating Requirements specified herein. As used herein, the phrase "maintain current" means that the list filed with the City is updated by the permittee prior to the contractor commencing work pursuant to the permit.

H. Inspections. Permit holders and property owners shall permit authorized representatives of any Department of the City having enforcement powers to inspect the premises proposed to be permitted, with or without advanced notice, as often as may be required to permit said Departments to perform their duties and assure compliance with this ordinance, without first obtaining a special inspection warrant. Inspections shall be made during normal hours of business operation in the absence of emergency circumstances which require prompt action to protect the public health, safety and welfare or to preserve evidence of noncompliance with this ordinance. The unreasonable failure to permit inspections shall be grounds for permit denial, suspension or revocation.

CODE OF GENERAL ORDINANCES, 2021 - KENOSHA, WISCONSIN

I. Summary Suspension.

If in the opinion of the Code Official, the public is subject to imminent danger due to the violation by the permittee of any one or combination of more than one of the General Operating Requirements, the Code Official shall issue an order to the permittee requiring immediate cessation of those operations implicating the imminent danger. Pursuant to such order, the permittee shall cause such operations to cease as directed by the Code Official. Failure to maintain insurance as required, to maintain the Irrevocable Letter of Credit as required, or to permit inspection as required are each per se violations implicating imminent danger to the public necessitating an order to cease all operations.

In the event that an order to the permittee requiring immediate cessation is issued by the Code Official, such order shall be considered by the Public Safety and Welfare Committee of the Common Council no later than at its next regular meeting. The Public Safety and Welfare Committee, after hearing from the Code Official, the permittee, and the public, shall affirm the order, reverse the order, or modify the order. The decision of the Public Safety and Welfare Committee may be appealed to the Common Council by either the Code Official or the permittee.

J. Non-renewal or Revocation Disciplinary Hearings. Disciplinary hearings, including nonrenewal, suspension and revocation hearings, shall be held before the Public Safety and Welfare Committee, which shall submit a report to the Common Council, including Findings of Fact, Conclusions of Law and a recommendation as to what action, if any, the Common Council should take with respect to the Permit. The Public Safety and Welfare Committee shall provide the Code Official and the permittee with a copy of the report. Either the Code Official or permittee may make an objection, orally or in writing, to the report and shall have the opportunity to present arguments supporting the objection to the Common Council. The Common Council shall determine whether the arguments shall be presented orally or in writing, or both. If the Common Council, after considering the Committee's report and any arguments presented by the Code Official and permittee, finds the complaint to be true, or if there is no objection to a report recommending a suspension, revocation or nonrenewal, the permittee shall be suspended, revoked or not renewed as provided by law. If the Common Council finds the complaint untrue, the proceedings shall be dismissed without cost to the accused. The City Clerk shall give notice of each suspension, revocation or nonrenewal to the party whose Permit is affected.

K. Transferability. Permits issued hereunder are personal to the applicant and are not transferable from person to person. Permits issued hereunder are issued to a particular site and are not transferable from place to place.

L. Enforcement. The Director of the Department of City Inspections shall have the primary responsibility to enforce this ordinance.

13.015 TEMPORARY CEMENT BATCH PLANTS

A. License Required. No person, party, firm or corporation shall operate a Temporary Cement Batch Plant, as herein defined, within the City without first obtaining a license therefor.

B. Definition. A Temporary Cement Batch Plant shall be defined as a place or facility which is not permanent in character and which is not intended to operate on a year round basis where cement is mixed with such as sand, stone, limestone, water or other substances for the purpose of forming concrete, which concrete will be used on or at premises other than the premises constituting the Temporary Cement Batch Plant.

C. Fee and Term. The license fee shall be Fifty (\$50.00) Dollars per license year, which fee shall not be prorated. The license term shall be from January 1 through December 31 of each year.

D. Application. Application for a license hereunder shall be to the Office of the City Clerk, on forms prescribed by the City Clerk, accompanied with the license fee.

CODE OF GENERAL ORDINANCES, 2021 - KENOSHA, WISCONSIN

E. Issuance. Licenses hereunder shall be issued by the Common Council following an investigation and report by the Health Department and Department of City Development to the Committee on Licenses/Permits and following a report and recommendation of the Committee on Licenses/Permits to the Common Council, to all applicants complying with the following criteria.

1. Applicants must conduct its operation in accordance with all applicable City, State and Federal Laws, rules and regulations in an area properly zoned for such activity.

2. Applicants must either conduct the licensed operation in a fully enclosed facility, or in the alternative, conduct its operation situated in a manner and on a lot of such a size so that dust from the operation will not cause air or water pollution, cause personal injury or property damage, be a public or private nuisance or be a basis for annoyance or discomfort to the general public or to abutting property owners or occupiers.

F. Notice to Aldermen. Notice of all license applications shall be sent to the Alderman of the District wherein the licensed facility will be located.

G. Prohibition and Penalty. Any person, party, firm or corporation who operates a temporary cement batch plant without a proper and valid license or who operates or permits to be operated a licensed temporary cement batch plant in a manner which causes air or water pollution, causes personal injury or property damage, which is a public or a private nuisance, or which is a basis for annoyance or discomfort to the general public or to abutting property owners or occupiers, shall upon conviction, forfeit an amount of money not less than Twenty-Five (\$25.00) Dollars nor more than Five Hundred (\$500.00) Dollars per day of violation, each day of violation constituting a separate offense, together with the costs of the action, and in default of payment of such forfeiture and costs, shall be committed to the County Jail for a period not to exceed thirty (30) days.

H. Revocation and Suspension. The license may be revoked or suspended by the Common Council for violations of §E.1. and 2., hereof, for supplying false information resulting in the granting of this license, or for other just cause, following a public due process hearing to be held by the Committee on Finance.

13.02 PAWNBROKERS AND SECONDHAND ARTICLE AND JEWELRY DEALERS

A. Definitions. In this Section:

1. "**Article**" means any of the following articles except jewelry:

- a. Audiovisual equipment.
- b. Bicycles.
- c. China.
- d. Computers, printers, software and computer supplies.
- e. Computer toys and games.
- f. Crystal.
- g. Electronic equipment.
- h. Fur coats and other fur clothing.
- i. Ammunition and knives.
- j. Microwave ovens.
- k. Office equipment.
- l. Pianos, organs, guitars and other musical instruments.
- m. Silverware and flatware.
- n. Small electrical appliances.
- o. Telephones.

CODE OF GENERAL ORDINANCES, 2021 - KENOSHA, WISCONSIN

- p. Furniture.
- q. Clothing.
- r. Video tapes or discs, audio tape or discs, and other optical media.

2. **"Charitable organization"** means a corporation, trust or community chest, fund or foundation, organized and operated exclusively for religious, charitable, scientific, literary or educational purposes or for the prevention of cruelty to children or animals, no part of the net earnings of which inures to the benefit of any private shareholder or individual.

3. **"Customer"** means a person with whom a pawnbroker, secondhand article dealer or secondhand jewelry dealer or an agent thereof engages in a transaction of purchase, sale, receipt or exchange of any secondhand article or secondhand jewelry.

4. **"Jewelry"** means any tangible personal property ordinarily wearable on the person and consisting in whole or in part of any metal, mineral or gem customarily regarded as precious or semiprecious.

5. **"Pawnbroker"** means any person who engages in the business of lending money on the deposit or pledge of any article or jewelry, or purchasing any article or jewelry with an expressed or implied agreement or understanding to sell it back at a subsequent time at a stipulated price.

6. **"Person"** means any person, firm, partnership, association, corporation, company or organization of any kind.

7. **"Secondhand"** means owned by any person, except a wholesaler, retailer or secondhand article dealer or secondhand jewelry dealer licensed under this Section, immediately before the transaction at hand.

8. **"Secondhand Article Dealer"** means any person who primarily engages in the business of purchasing or selling secondhand articles, except when engaging in any of the following:

a. Any transaction at an occasional garage or yard sale, an estate sale, a gun, knife, gem or antique show, a convention or an auction.

b. Any transaction entered into by a person while engaged in a business for which the person is licensed under Sub. B. or D. or while engaged in the business of junk collector, junk dealer, auctioneer or scrap processor as described in §70.995(2)(x), Wisconsin Statutes.

c. Any transaction while operating as a charitable organization or conducting a sale the proceeds of which are donated to a charitable organization.

d. Any transaction between a buyer of a new article and the person who sold the article when new which involves any of the following:

(1) The return of the article.

(2) The exchange of the article for a different, new article.

e. Any transaction as a purchaser of a secondhand article from a charitable organization if the secondhand article was a gift to the charitable organization.

f. Any transaction as a seller of a secondhand article which the person bought from a charitable organization if the secondhand article was a gift to the charitable organization.

CODE OF GENERAL ORDINANCES, 2021 - KENOSHA, WISCONSIN

9. "Secondhand Jewelry Dealer" means any person who engages in the business of any transaction consisting of purchasing, selling, receiving or exchanging secondhand jewelry, except for the following:

a. Any transaction at an occasional garage or yard sale, an estate sale, a gun, knife, gem or antique show, a convention or an auction.

b. Any transaction with a licensed secondhand jewelry dealer.

c. Any transaction entered into by a person while engaged in a business of smelting, refining, assaying or manufacturing precious metals, gems or valuable articles if the person has no retail operation open to the public.

d. Any transaction between a buyer of new jewelry and the person who sold the jewelry when new which involves any of the following:

(1) The return of the jewelry.

(2) The exchange of the jewelry for different, new jewelry.

e. Any transaction as a purchaser of secondhand jewelry from a charitable organization if the secondhand jewelry was a gift to the charitable organization.

f. Any transaction as a seller of secondhand jewelry which the person bought from a charitable organization if the secondhand jewelry was a gift to the charitable organization.

B. License For Pawnbroker. No person may operate as a pawnbroker unless the person first obtains a pawnbroker's license under this Section.

C. License For Secondhand Article Dealer.

1. Except as provided in §2., no person may operate as a secondhand article dealer unless the person first obtains a secondhand article dealer's license under this Section.

2. A person who operates as a secondhand article dealer only on premises or land owned by a person having a secondhand dealer mall or flea market license under §K. need not obtain a secondhand article dealer's license.

D. License For Secondhand Jewelry Dealer. No person may operate as a secondhand jewelry dealer unless the person first obtains a secondhand jewelry dealer's license under this Section.

E. License Application. A person wishing to operate as a pawnbroker, secondhand article dealer or secondhand jewelry dealer in the City of Kenosha shall make application to the City Clerk for a license, accompanied by the required fee. The City Clerk shall furnish application forms, which shall require the following:

1. The applicant's name, place and date of birth and residence address.

2. The names and addresses of the business and of the owner of the business premises.

3. A statement as to whether the applicant has been convicted within the preceding ten (10) years of a felony or within the preceding five (5) years of a misdemeanor, statutory violation punishable by forfeiture or county or municipal Ordinance violation in which the circumstances of the felony, misdemeanor or other

CODE OF GENERAL ORDINANCES, 2021 - KENOSHA, WISCONSIN

offense substantially relate to the circumstances of the licensed activity and, if so, the nature and date of the offense and the penalty assessed.

4. Whether the applicant is a natural person, corporation or partnership, and:

a. If the applicant is a corporation, the state where incorporated and the names and addresses of all officers and directors.

b. If the applicant is a partnership, the names and addresses of all partners.

4. The name of the manager or proprietor of the business.

5. Any other information that the Police Department or City Clerk may reasonably require.

F. Investigation Of License Applicant. Upon receipt of an application, the City Clerk shall send copies thereof to the Department of City Development, Department of City Inspections and the Kenosha Police Department. The Department of City Development, Department of City Inspections, within ten (10) days of receiving such copy, shall make a report, in writing, to the Committee on Licenses/Permits as to whether the premises meet the requirements of this Chapter and the Building and Zoning Codes. The Kenosha Police Department shall investigate each applicant for a pawnbroker's, secondhand article dealer's or secondhand jewelry dealer's license to determine whether the applicant has been convicted within the preceding ten (10) years of a felony or within the preceding five (5) years of a misdemeanor, statutory violation punishable by forfeiture or county or municipal Ordinance violation described under **E.3.** and, if so, the nature and date of the offense and the penalty assessed. The Kenosha Police Department shall furnish the information derived from that investigation in writing to the City Attorney. The City Attorney, or his or her designee, shall examine said record and make a recommendation based thereon as to whether or not the license should be granted. Such reports shall be delivered to the City Clerk or Clerk for the Committee on Licenses/Permits who, in turn shall deliver them, with the application, to the Committee on Licenses/Permits. Such Committee shall recommend to the Common Council either the granting or denial of the application, or such other action as may be appropriate.

G. License Issuance.

1. The Common Council shall grant the license if all of the following apply:

a. The applicant, including an individual, a partner or an officer, director or agent of any corporate applicant, has not been convicted within the preceding ten (10) years of a felony or within the preceding five (5) years of a misdemeanor, statutory violation punishable by forfeiture or county or municipal Ordinance violation in which the circumstances of the felony, misdemeanor or other offense substantially relate to the circumstances of being a pawnbroker, secondhand jewelry dealer, secondhand article dealer or secondhand article dealer mall or flea market owner.

b. With respect to an applicant for a pawnbroker's license, the applicant provides the City Clerk with a Five Hundred (\$500) Dollar bond, with at least two (2) sureties, for the observation of all City of Kenosha Ordinances relating to pawnbrokers.

2. No license issued under this Subsection shall be transferred.

3.a. Each license for a pawnbroker, secondhand article dealer or secondhand jewelry dealer is valid from January 1 until the following December 31.

b. Each license for a secondhand article dealer mall or flea market is valid for two (2) years, from May 1 of an odd numbered year until April 30 of the next odd numbered year.

CODE OF GENERAL ORDINANCES, 2021 - KENOSHA, WISCONSIN

H. Fees. The license fees under this Section are:

1. For a Pawnbroker's License, \$1,000
2. For a Secondhand Article Dealer's License, \$100
3. For a Secondhand Jewelry Dealer's License, \$500
4. For a Secondhand Article Dealer Mall or Flea Market License, \$165.

I. License Revocation. The Common Council of the City of Kenosha may revoke any license issued by it under this Section for fraud, misrepresentation or false statement contained in the application for a license or for any violation of this Section or §§943.34 (receiving stolen property), 948.62 (receiving stolen property from a child) or 948.63 (receiving property from a child), Wisconsin Statutes.

J. Pawnbroker And Dealer Requirements.

1. Identification. No pawnbroker, secondhand article dealer or secondhand jewelry dealer may engage in a transaction of purchase, receipt or exchange of any secondhand article or secondhand jewelry from a customer without first securing adequate identification from the customer. At the time of the transaction, the pawnbroker, secondhand article dealer or secondhand jewelry dealer shall require the customer to present one of the following types of identification:

- a. A County identification card.
- b. A State identification card.
- c. A valid Wisconsin motor vehicle operator's license.
- d. A valid motor vehicle operator's license, containing a picture, issued by another state.
- e. A military identification card.
- f. A valid passport.
- g. An alien registration card.
- h. A senior citizen's identification card containing a photograph.
- i. Any identification document issued by a state or federal government, whether or not containing a picture, if the pawnbroker, secondhand article dealer or secondhand jewelry dealer obtains a clear imprint of the customer's right index finger.

2. Transactions With Minors.

a. Except as provided in §b., no pawnbroker, secondhand article dealer or secondhand jewelry dealer may engage in a transaction of purchase, receipt or exchange of any secondhand article or secondhand jewelry from any minor.

b. A pawnbroker, secondhand article dealer or secondhand jewelry dealer may engage in a transaction described under §a., if the minor is accompanied by his or her parent or guardian at the time of the transaction or if the minor provides the pawnbroker, secondhand article dealer or secondhand jewelry dealer with the parent's or guardian's written and notarized consent to engage in the particular transaction.

3. Records.

a. Except as provided in §b., for each transaction of purchase, receipt or exchange of any secondhand article or secondhand jewelry from a customer, a pawnbroker, secondhand article dealer or secondhand jewelry dealer shall:

(1) Require the customer to complete and sign, in ink, the appropriate form provided by the City of Kenosha or the Department of Agriculture. No entry on such form may be erased, mutilated or changed. The pawnbroker, secondhand article dealer or secondhand jewelry dealer shall retain an original and a duplicate of each form for not less than one (1) year after the date of the transaction except as provided in

CODE OF GENERAL ORDINANCES, 2021 - KENOSHA, WISCONSIN

¶15, and during that period shall make the duplicate available to any law enforcement officer for inspection at any reasonable time.

- (2) Take a color photograph, a digital image or a video recording of:
 - (a) Each customer involved in a billable transaction.
 - (b) Every item pawned or sold.

If a photograph is taken, it must be at least two inches in length by two inches in width and must be maintained in such a manner that the photograph can be readily matched and correlated with all other records of the transaction to which they relate. Such photographs must be available to the Chief of Police, or the Chief's designee, upon request. The major portion of the photograph must include an identifiable facial image of the person who pawned or sold the item. Items photographed must be accurately depicted.

If a digital image is taken, it must be in a format specified by the police department, electronically cross-referenced to the reportable transaction they are associated with. Such images must be available to the Chief of Police, or the Chief's designee, upon request. The major portion of the image must include an identifiable facial image of the person who pawned or sold the item. Items recorded by digital image must be accurately depicted.

If a video photograph is taken, the video camera must focus on the person pawning or selling the item so as to include an identifiable image of that person's face. Video recordings must be available to the Chief of Police, or the Chief's designee, upon request. Items photographed by video must be accurately depicted. Video photographs must be electronically referenced by time and date so they can be readily matched and correlated with all other records of the transaction to which they relate.

Photographs, digital images and video recordings shall be retained by the pawnbroker, secondhand article dealer or secondhand jewelry dealer for not less than one (1) year after the date of the transaction.

The Licensee must inform the person that he or she is being photographed and/or videotaped by displaying a sign of sufficient size in a conspicuous place on the premises.

b. For every secondhand article consigned to the secondhand article dealer for sale on the secondhand article dealer's premises, the secondhand article dealer shall keep a written inventory. In this inventory the secondhand article dealer shall record the name and address of each customer, the date, time and place of the transaction and a detailed description of the article which is the subject of the transaction. The customer shall sign his or her name, address and telephone number on a declaration of ownership of the secondhand article identified in the inventory and shall state that he or she owns the secondhand article. The secondhand article dealer shall retain an original and a duplicate of each entry and declaration of ownership relating to the purchase, receipt or exchange of any secondhand article for not less than one (1) year after the date of the transaction except as provided for in ¶15., and shall make duplicates of the inventory and declarations of ownership available to any law enforcement officer for inspection at any reasonable time.

4. Holding Period.

a. Except as provided in §d. and f., any secondhand article or secondhand jewelry purchased or received by a pawnbroker shall be kept on the pawnbroker's premises or other place for safekeeping for not less than thirty (30) days after the date of purchase or receipt, unless the person known by the pawnbroker to be the lawful owner of the secondhand article or secondhand jewelry recovers it.

b. Except as provided in §d. and f., any secondhand article purchased or received by a secondhand article dealer shall be kept on the secondhand article dealer's premises or other place for safekeeping for not less than twenty-one (21) days after the date of purchase or receipt.

c. Except as provided in §d. and f., any secondhand jewelry purchased or received by a secondhand jewelry dealer shall be kept on the secondhand jewelry dealer's premises or other place for safekeeping for

CODE OF GENERAL ORDINANCES, 2021 - KENOSHA, WISCONSIN

not less than twenty-one (21) days after the date of purchase or receipt.

d. If a pawnbroker, secondhand article dealer, or secondhand jewelry dealer is required to submit a report under par. (5) concerning a secondhand article or secondhand jewelry purchased or received by the pawnbroker, secondhand article dealer, or secondhand jewelry dealer and the report is required to be submitted in an electronic format, the secondhand article or secondhand jewelry shall be kept on the pawnbroker's, secondhand article dealer's or secondhand jewelry dealer's premises or other place for safekeeping for not less than ten (10) days after the report is submitted.

e. During the period set forth in §§a., b., c. or d., the secondhand article or secondhand jewelry shall be held separate and apart and may not be altered in any manner. The pawnbroker, secondhand article dealer or secondhand jewelry dealer shall permit any law enforcement officer to inspect the secondhand article or secondhand jewelry during this period. Within twenty-four (24) hours after a written request of a law enforcement officer during this period, a pawnbroker, secondhand article dealer or secondhand jewelry dealer shall make available for inspection any secondhand article or secondhand jewelry which is kept off the premises for safekeeping. Any law enforcement officer who has reason to believe any secondhand article or secondhand jewelry was not sold or exchanged by the lawful owner may direct a pawnbroker, secondhand article dealer or secondhand jewelry dealer to hold that secondhand article or secondhand jewelry for a reasonable length of time which the law enforcement officer considers necessary to identify it.

f. Sections a. to d. do not apply to any to any of the following:

- (1) A coin of the United States, any gold or silver coin or gold or silver bullion.
- (2) A secondhand article or secondhand jewelry consigned to a pawnbroker, secondhand article dealer or secondhand jewelry dealer.

5. Report To Law Enforcement Agency.

a. Within twenty-four (24) hours after purchasing or receiving a secondhand article or secondhand jewelry, a pawnbroker, secondhand article dealer or secondhand jewelry dealer shall make available, for inspection by a law enforcement officer, the original form completed under ¶3.a. or the inventory under ¶3.b., whichever is appropriate.

b. Every pawnbroker, secondhand article dealer or secondhand jewelry dealer shall, within seven (7) days after receiving the secondhand article or secondhand jewelry, send to the Chief of Police a photocopy of the original form completed under ¶3.a.

c. Notwithstanding §19.35(1), Wisconsin Statutes, a law enforcement agency receiving the original form or inventory or a declaration of ownership may disclose it only to another law enforcement agency.

d. Effective no later than sixty (60) days after the police department provides a pawnbroker, secondhand article dealer, or secondhand jewelry dealer with the current version of the software utilized by the police department, a pawnbroker, secondhand article dealer, or secondhand jewelry dealer must submit every reportable transaction to the police department daily by transferring it electronically to the police department in the manner designated by the Kenosha Police Department. All required records must be transmitted completely and accurately after the close of business each day in accordance with the standards and procedures established by the police department.

(1) The pawnbroker, secondhand article dealer or secondhand jewelry dealer must display a sign of sufficient size in a conspicuous place on the premises, which informs all patrons that all transactions are reported daily to the police department.

(2) If a pawnbroker, secondhand article dealer or secondhand jewelry dealer is unable to successfully transfer the required reports electronically, the pawnbroker, secondhand article dealer or secondhand jewelry dealer must provide the police department with printed copies of all reportable transactions by 12:00 noon the

CODE OF GENERAL ORDINANCES, 2021 - KENOSHA, WISCONSIN

next business day.

(3) If the problem is determined to be in the pawnbroker's, secondhand article dealer's or secondhand jewelry dealer's system and is not corrected by the close of the first business day following the failure, the pawnbroker, secondhand article dealer or secondhand jewelry dealer must provide the required reports as required by this Ordinance, and shall be charged a daily reporting failure fee of \$10.00 until the error is corrected; or, if the problem is determined to be outside the pawnbroker's, secondhand article dealer's or secondhand jewelry dealer's system, the pawnbroker, secondhand article dealer or secondhand jewelry dealer must provide the required reports pursuant to the Ordinance and resubmit all such transactions electronically when the error is corrected.

(4) Regardless of the cause or origin of the technical problems that prevented the pawnbroker, secondhand article dealer or secondhand jewelry dealer from uploading the reportable transactions, upon correction of the problem, the pawnbroker, secondhand article dealer or secondhand jewelry dealer shall upload every reportable transaction from every business day the problem has existed.

(5) The provisions of this section notwithstanding, the police department may, upon presentation of extenuating circumstances, delay the implementation of the daily reporting penalty.

6. Exception For Customer Return Or Exchange. Nothing in this Subsection applies to the return or exchange, from a customer to a secondhand article dealer or secondhand jewelry dealer, of any secondhand article or secondhand jewelry purchased from the secondhand article dealer or secondhand jewelry dealer.

7. Altered Serial Number. No pawnbroker, secondhand article dealer or secondhand jewelry dealer may receive any item of property that possesses an altered or obliterated serial number or operation identification number or any item of property that has had its serial number removed.

8. Business at Only One Place. A License under this chapter authorizes the Licensee to carry on its business only at the permanent place of business designated in the License. However, upon written request, the Chief of Police, or the Chief's designee, may approve an off-site locked and secured storage facility. The Licensee shall permit an inspection of the facility in accordance with this Chapter. All provisions of this Chapter regarding record keeping and reporting apply to the facility and its contents. Property shall be stored in compliance with all provisions of the city code. The Licensee must either own the building in which the business is conducted, and any approved off-site storage facility, or have a lease on the business premises that extends for more than six (6) months.

9. Payment.

a. All payments made by a pawnbroker who lends money on the deposit or pledge of any article or jewelry or who purchases any article or jewelry shall be made by check or automated clearing house.

b. All payments of more than Twenty-Five Dollars (\$25.00) made by a secondhand article dealer for the purchase of any secondhand article shall be made by check or automated clearing house.

c. All payments made by a secondhand jewelry dealer for the purchase of any jewelry shall be made by check or automated clearing house.

K. Secondhand Article Dealer Mall Or Flea Market.

1. The owner of any premises or land upon which two (2) or more persons operate as secondhand article dealers may obtain a secondhand article dealer mall or flea market license for the premises or land if the following conditions are met:

a. Each secondhand article dealer occupies a separate sales location and identifies himself or herself to the public as a separate secondhand article dealer.

CODE OF GENERAL ORDINANCES, 2021 - KENOSHA, WISCONSIN

b. The secondhand article dealer mall or flea market is operated under one (1) name and at one (1) address, and is under the control of the secondhand article dealer mall or flea market license holder.

c. All sales are completed at a central location under the control of the secondhand article dealer mall or flea market license holder, who maintains a record of all sales.

2. The secondhand article dealer license holder or flea market licensed holder and each secondhand article dealer operating upon the premises or land shall comply with §J.

L. Penalty.

1. Upon conviction for a first offense under this Section, a person shall forfeit not less than Fifty (\$50) Dollars nor more than One Thousand (\$1,000) Dollars.

2. Upon conviction for a second or subsequent offense under this Section, a person shall forfeit not less than Five Hundred (\$500) Dollars nor more than Two Thousand (\$2,000) Dollars.

M. Severability. Should any section, paragraph, sentence, clause or phrase of this Ordinance be declared unconstitutional or invalid or be repealed, it shall not affect the validity of the Ordinance as a whole or any part thereof, other than the part so declared to be invalid or repealed.

13.025 CHARITABLE, RELIGIOUS AND POLITICAL SOLICITATIONS

It shall be unlawful for any person, firm or corporation to solicit or cause to be solicited contributions of money, goods or services to be utilized for a charitable, religious or political purpose in a residentially zoned area without a prearranged appointment during the hours of 8:00 P.M. to 8:00 A.M.

In the event that it is determined by a Court of law that the City cannot constitutionally prohibit such solicitation during the hours of 8:00 P.M. to 9:00 P.M., then the hours of prohibited solicitation shall be the hours of 9:00 P.M. to 8:00 A.M.

13.03 PEDDLERS

A. Purpose. The purpose and intent of this Ordinance is to regulate unsolicited contacts with the citizens of this City designed to influence the citizen to buy or accept periodicals, goods, merchandise or services.

B. License Required. It shall be unlawful for any person to engage in the business of a "Peddler" or perform the act of "Peddling", as herein defined, within the City, without first having obtained a license from the City Clerk.

C. License Not Required. The following shall be excluded herefrom:

1. Persons selling to or taking orders from any retail or wholesale business establishment.
2. Persons selling or taking orders for agricultural products grown by said persons within the State of Wisconsin.
3. Persons under the age of 18 who sell or take orders for a newspaper which said persons deliver within the City where said sale of order occurs in the normal course of delivering said newspaper.
4. Persons who under the state license engage in the real estate or insurance business.
5. Persons selling or taking orders by prearranged appointment.

CODE OF GENERAL ORDINANCES, 2021 - KENOSHA, WISCONSIN

6. Persons selling at art, craft, and antique shows, at rummage fairs, and at trade shows.

Persons herein excluded are not excused from complying with any other Ordinances, laws, rules or regulations of the City.

D. Definitions.

1. **"Peddler"** shall be defined as any natural person who for personal profit or gain sells or takes orders for periodicals, goods, food, beverage, merchandise or services within the City, irrespective of the delivery or performance date where the sale or order occurs within the City, upon premises which are not owned or which are not rented or leased for a period of thirty (30) or more consecutive days by said person, or from any vehicle as defined by Section 340.01(74), Wisconsin Statutes.

2. A person of **"good moral character"** shall be defined as one who has:

- a. Conducted himself in an honest, law abiding and truthful manner,
- b. Honored his oral and written promises, guarantees and warranties,
- c. Filed a full, complete and accurate application for a license,
- d. Abided by local, state and federal laws governing the activity herein licensed.
- e. Not been convicted of a felony or of a misdemeanor involving violence or moral turpitude during the license period or two years prior to the date of application for a license, unless pardoned therefore.

E. Application. Application for said license shall be made to the City Clerk on forms supplied by the City Clerk. The application shall contain a statement of the periodicals, goods, food, beverage, merchandise or service which will be sold, or for which orders will be taken, a statement of the manner in which said activity or business will be conducted, and a list of the last three (3) municipalities in which a similar business or activity, as herein regulated, was conducted by the applicant. There shall be a waiting period of seventy-two (72) hours, not including weekends and holidays commencing at 8:00 A.M. of the day following the date at which a properly completed application was filed with the City Clerk during which period of time the application, at the request of the City Clerk, shall be investigated by the Police Department and by the Health Department where food, drinks, or produce is involved; and, in appropriate circumstances, the State of Wisconsin Department of Agriculture, Trade and Consumer Protection. Should the investigation indicate that the applicant appears to be of good moral character, the City Clerk shall issue a license. Should the investigation indicate that the individual is not of good moral character, the license shall be denied in writing, with a special statement or the reasons for a denial. The applicant shall be given an opportunity to appeal the City Clerk's denial of said license to the Committee on Finance by filing a written request for such a hearing with the City Clerk. Should the individual fail to appear at said hearing, the License shall be denied. Should the individual appear, the Committee on Finance will determine the propriety of granting or denying of a license by a specific finding of fact and conclusion.

F. Photographs. With every application, applicant shall submit two (2) identical color photographs of applicant alone, sufficiently recent to be a good likeness of applicant (taken within the last six (6) months), and 2 inches x 2 inches in size. The image size, measured from the bottom of applicant's chin to the top of his/her head (including hair), should not be less than one (1") inch and not more than 1-3/8 inches. The photographs must be color, clear, with a full front view of applicant's face, and printed on thin paper with plain light (white or off-white) background. The photographs must be taken in normal street attire, without a hat, head covering, or dark glasses, unless a signed statement is submitted by the applicant verifying the item is worn daily for religious purposes, or a signed doctor's statement is submitted verifying the item is used daily for medical purposes. Photographs retouched so that applicant's appearance is changed are unacceptable. Snapshots, most vending machine prints, and magazine or full length photographs are unacceptable. Digitized photographs must meet the previously stated qualifications and will be accepted for use at the discretion of the City Clerk.

G. License Fee. The license fee shall be Two Hundred Fifty (\$250.00) Dollars per person, per license period, or any portion thereof. The full license fee must be submitted with the application in reasonable

CODE OF GENERAL ORDINANCES, 2021 - KENOSHA, WISCONSIN

denominations of lawful United States tender.

H. License Period. The License period shall be for a one (1) year period from October 1 to September 30th of each year with no proration of the License fee.

I. Insurance Requirement. All licensees who will use a motor vehicle in the performance of activities herein licensed must present to the City Clerk, with his or her application, proof of automobile liability insurance which meets the minimum requirements of the State Financial Responsibility Law.

J. Motor Vehicle Inspection, Report, and Identification. All licensees who use a motor vehicle in the performance of activities herein licensed are subject to the inspection and reporting requirements hereinafter set forth:

1. Motor vehicles shall, at the cost and expense of applicant/permit holder, be inspected by an Automotive Service Excellence (A.S.E.) Certified Technician, certified in the areas of "brakes" and "suspension and steering", who shall fill out, date and sign a Safety and Maintenance Inspection Report and provide a copy of their certification. The Report shall verify that the motor vehicle inspected is safe for operation on City streets. The Report shall be filed with the City Clerk/Treasurer with the permit application/renewal or at any time prior to which a motor vehicle will be utilized, or at any time directed by the Police Chief or designee thereof, based upon personal observation of a police officer indicating a lack of required maintenance. A copy of the Report shall be kept in the motor vehicle at all times used in the performance of activities herein licensed and shall be made available for review at any time directed by the Police Chief or designee thereof.

2. Every motor vehicle shall be conspicuously and legibly marked on both sides of the vehicle with the name of the owner in letters not less than two and one-half (2-1/2") inches in height and in a color contrasting with the color of the vehicle.

K. Driver's License. All licensees who will use a motor vehicle in the performance of activities herein licensed shall hold a valid driver's license, a copy of which shall be filed with the City Clerk/Treasurer.

L. Identification. All licensees shall conspicuously wear their license on their person while engaged in the licensed business or activity and shall produce the same upon the demand of any law enforcement officer. It shall be a violation of this Ordinance to fail to comply with this Subsection even though a person may be otherwise validly licensed hereunder.

M. Limitation. It shall be unlawful for any person, firm or corporation to engage in peddling in a residentially zoned area without a prearranged appointment during the hours of 8:00 P.M. and 8:00 A.M.

N. NonTransferable. Each license issued shall be individual and nontransferable.

O. Enforcement. The Police Department, and where food or produce is involved, the Health Department, shall have the responsibility for enforcing this Ordinance.

P. Suspension, Revocation or NonRenewal of License. This license may be suspended, revoked or not renewed upon a ten (10) day advance written notice being furnished to the licensee by the City Attorney or City Clerk charging the licensee with a failure to be of good moral character as herein defined, or with a failure to comply with the terms of this Ordinance, or with pursuing licensed activities in a manner injurious or threatening to be injurious to the public health, safety, welfare and tranquility of the City. Hearing upon said notice shall be before the Finance Committee or the Common Council. There shall be a written Findings of Fact and Conclusions of Law which shall, if possible, be mailed to the licensee at the address given at the hearing, within 5 working days following the date of the hearing.

Q. Restriction. Peddling may not be engaged in within the right of way of the Kenosha Civic Veterans Parade route during the Kenosha Civic Veterans Parade. Peddling may not be engaged in within eight hundred (800') feet of any permanent business retailing similar or competing products located in a permanent building or structure, except:

CODE OF GENERAL ORDINANCES, 2021 - KENOSHA, WISCONSIN

1. For food vendors possessing all required licenses and permits who are temporarily and incidentally in the vicinity of a permanent business retailing similar or competing products.
2. Sidewalk sales.
3. Organizations not licensed under this Ordinance.

13.031 USE OF UNLICENSED PEDDLERS PROHIBITED

It shall be unlawful for any person, party, firm or corporation to hire, contract with, or otherwise utilize the service of a peddler, as defined in §13.03 of the Code of General Ordinances, who is not licensed when and as required by said Ordinance. Each day an unlicensed peddler performs such services shall constitute a separate violation hereof.

13.035 PEDDLER'S STANDS AND OTHER STRUCTURES AS OBSTRUCTIONS

No person, firm, party or corporation shall place or maintain a stand or structure from which peddling, as defined in §13.03, Ordinances, is engaged in or which are used for any other purposes, upon any City property, including parks, street right-of-ways, sidewalks and lawn park areas, without first having obtained permission of the Common Council therefor. A peddler stand may be established either in a peddler zone or in conjunction with a public event. Peddler's stands shall not be authorized within eight hundred (800') feet of any permanent business retailing similar or competing products located in a permanent building or structure and peddler's stands and other structures shall not be authorized where likely to create a public or private nuisance, or otherwise disturb the peace or obstruct vehicular or pedestrian traffic.

A person shall be deemed to have a "stand", although there is no structure associated therewith, whenever a person remains in any one location for more than fifteen (15) minutes within an eight (8) hour period of time. A "peddler zone" shall be defined as an area within the City approved by the City of Kenosha Common Council or the City of Kenosha Board of Park Commissioners for the specific operation of approved Peddler Stands upon any City Property, including parks, streets, right-of-ways, sidewalks and lawn park areas. Peddler zones will be established by resolution of the Common Council or the Board of Park Commissioners. A list of established peddler zones will remain on file with the City Clerk. A "location" shall be defined as any City property including parks, street rights-of-way, sidewalks and lawn park areas. A "right-of-way" shall be defined as being within one hundred fifty (150') feet of any street or highway intersection measured from the center point thereof and shall also be defined as being within a right-of-way on either side of a street or highway from intersection to intersection.

Applications for permits shall be filed with the City Clerk on forms approved by the City Clerk, accompanied by a location map drawn (specificity/to scale) identifying the proposed location of the stand and the required fee. Annual permits shall be for the period of October 1 through September 30 of each year. The fee for an annual permit is One Hundred Dollars (\$100.00) and shall be nonproratable. A one (1) day permit may be issued for one (1) day designated by the applicant. The fee for a one (1) day permit is Twenty-five Dollars (\$25.00). A separate permit shall be required for each "stand".

Person(s) peddling from a stand as defined herein shall not be required to hold an individual peddler's license as required by §13.03.

A. Review. In reviewing a peddler stand permit application, the Common Council shall consider whether the proposed stand transactions are:

- (1) Customarily associated with public use and enjoyment of the location proposed for the stand.
- (2) In furtherance of public use and enjoyment of the location proposed for the stand.

CODE OF GENERAL ORDINANCES, 2021 - KENOSHA, WISCONSIN

(3) Incidental to an appropriate recreational or cultural use of the location proposed for the stand.

B. Operation. Peddler stands issued a permit pursuant to Subsection A shall be subject to the following operations requirements:

(1) **Location.** The stand location shall be limited to the area described in the permit application and approved by the Council. The Director of Public Works may, upon written notice, relocate a stand location situated within the perimeter of a public event approved by the Public Works Committee or the Parks Commission as necessary so as to avoid interference with activities and equipment which are part of the public event.

(2) **Probationary Term.** An approved location shall be subject to a probationary period of thirty (30) consecutive days. If no written complaints or objections with respect to the approved location are received by the Clerk during the probationary period, the location shall be the "location" of the stand for the remainder of the licensing period. If a complaint or objection is received, it shall be forwarded to the Common Council for further consideration of the stand location. The probationary period shall be extended as long as the location remains under Council consideration. The Council shall either confirm or amend the location. Each stand may be relocated subject to the filing of a new permit application during the term of the permit and upon Common Council approval. This section is not applicable to a one (1) day permit issued pursuant to this section.

(3) **Hours of Operation.** Peddling is permitted at a stand location between the hours of 9:00 a.m. and 8:00 p.m.

(4) **Special Events.** Vendors associated with special events which have received the required approval to be located on City Property shall not be required to obtain a peddler stand permit for the special event.

(5) **Utilities.** Vendors which require use of public utilities shall pay utility charges as designated by Superintendent of Parks.

(6) **Noise.** Noise levels emanating from the stand shall be kept to a minimum and shall be reasonable so as not to disturb the peace and quiet of those in the vicinity, including but not limited to residents, merchants and customers. Vendors shall be subject to all applicable City ordinances regarding noise and amplification and this ordinance shall not be interpreted to expand or contradict those other ordinances. In the event of a conflict, the more strict regulation or ordinance shall apply.

13.036 TRESPASS FOR COMMERCIAL PURPOSES

It shall be unlawful for any person, party, firm or corporation to sell or take orders for or to permit the sale or the taking of orders for any merchandise, goods or service from any private property where the owner or lessee having jurisdiction thereover has not provided written permission for said activities.

13.037 TRESPASS-PEDDLERS AND SOLICITORS

It shall be unlawful for any person, party, firm or corporation to peddle, within the meaning of §13.03 of the Code of General Ordinances, or to solicit within the meaning of §13.025 of the Code of General Ordinances, upon any private property which is posted with a sign, in a manner sufficient to provide notice, prohibiting either or both of said activities.

CODE OF GENERAL ORDINANCES, 2021 - KENOSHA, WISCONSIN

13.04 CONVENIENT CASH BUSINESSES

A. Intent and Purpose. It is the purpose of this Ordinance to regulate the hours of operation of all Convenient Cash Businesses. The majority of existing Convenient Cash Businesses, as defined in Subsection B. below, are located near residential areas where business hours may impact the residents of the area. Convenient Cash Businesses, like other financial businesses, do not provide services that must be available twenty-four (24) hours per day. The Ordinance is deemed for the benefit of the health, safety and welfare of the public.

B. Definition. "Convenient Cash Business(es)", also referred to as "payday loan business", "title for cash business", "check cashing business", or any similar enterprise, shall mean any business licensed pursuant to Sections 138.09 or 218.05, Wisconsin Statutes, which provides nontraditional, short-term consumer loans by accepting a check or title, holding the check or title for a period of time before negotiating or presenting the check or title for payment, and paying to the issuer an agreed upon amount of cash, or refinancing or consolidating such a transaction.

C. Hours of Operation.

1. No physical premises [as defined by its Occupancy Permit] in which a Convenient Cash Business holding a license issued pursuant to Section 138.09, Wisconsin Statutes, is operated may be open between the hours of 7:00 P.M. and 8:00 A.M.

2. No physical premises [as defined by its Occupancy Permit] in which a Convenient Cash Business holding a license issued pursuant to Section 218.05, Wisconsin Statutes, is operated may be open between the hours of Midnight (12:00 A.M.) And 5:00 A.M.

3. Any Convenient Cash Business holding a license issued pursuant to Section 138.09, Wisconsin Statutes, and a license issued pursuant to Section 218.05, Wisconsin Statutes, that operates under both licenses at the same physical premises [as defined by its Occupancy Permit] shall be subject to the hours of operation set forth in Subsection C.1. above.

13.06 NATURAL GAS

The Wisconsin Electric Power Company is authorized to occupy the streets, highways, and thoroughfares of the City for purposes of installing and maintaining natural gas lines and supplying natural gas.

13.07 TAXICABS AND DRIVERS

A. Definitions. The term taxicab as used herein shall include all vehicles carrying passengers for hire, except such vehicles as operate on established routes and regulated by the Public Service Commission of Wisconsin; and excepting also such vehicles as are rented to be driven by the renter or his agent, and except vehicles operated solely as funeral cars and except ambulance services licensed by the State, and excepting limousine services which charge on the basis of an hourly rate for the use of a car and driver and which require the reservation of a car and driver at least twenty-four (24) hours in advance of use, and excepting a private trolley service, utilizing no more than one (1) motor vehicle which runs on standard tires, which is used for tours, and which is insured in accordance with the minimum limits of the State's Motor Vehicle Financial Responsibility Laws, and vehicles licensed and operating as Handicapped-Elderly Vehicles, as defined in Section 13.09 A.2. of the Code of General Ordinances.

B. Permit Fees and Term. Every person, firm or corporation who shall engage in taxicab business

CODE OF GENERAL ORDINANCES, 2021 - KENOSHA, WISCONSIN

shall pay a permit fee of Seventy-five (\$75.00) Dollars per vehicle operated in such business.

All permits issued shall expire on the 30th day of June following their issue and may be renewed upon payment of the above fees.

C. Issuance of Permits.

1. Application. Any person, firm, association or corporation wishing to obtain a permit to engage in the business of conveyance of persons for hire within the City of Kenosha, shall present to the City Clerk a written application therefor, stating the name and address of applicant and number and type of vehicles proposed to be operated.

The City Clerk shall present all applications to the Common Council, together with all necessary reports and documents, who shall either grant or deny the applicant's request.

2. Insurance. No permit to operate a taxicab shall be issued unless:

a. The owner shall have filed with the City Clerk an insurance policy, by an insurance company licensed to do business in the State of Wisconsin, providing coverage for liability of a minimum of Twenty-Five Thousand Dollars (\$25,000.00) for injury or death to any one person, and subject to the same limit per person, a maximum liability of Fifty Thousand Dollars (\$50,000.00) for the injury or death of any number of persons in any one accident and a maximum liability of Ten Thousand (\$10,000) Dollars for property damage in any one accident, containing the provision for Fifty Dollars (\$50.00) deductible insurance on the property damage only; or,

b. A certificate of insurance acceptable to the State of Wisconsin.

c. Said policy or certificate shall further provide that the same cannot be cancelled until thirty (30) days notice of such cancellation shall be given to the City Clerk. The cancellation or other termination of any insurance policy or above mentioned certificate shall automatically revoke and terminate all permits issued for the taxicab covered by such insurance policy.

3. City Clerk to Issue. Before any such permit shall be issued, the applicant therefor shall pay to the City Clerk of the City of Kenosha the amount of money fixed by this Ordinance for such permit. The applicant shall, upon complying with all the provisions herein continued, be entitled to and shall receive from the City Clerk a written permit signed by such Clerk and countersigned by the Mayor, and attested by the seal of the City of Kenosha, authorizing such person, firm, association or corporation to carry on this business of conveying passengers for hire, and shall in addition thereto receive from the City Clerk the permit plate or plates hereinafter provided for.

4. Plates.

a. Issuance. Upon approval of the application and payment of the fee, the City Clerk shall issue a permit for each vehicle entitled thereto.

b. Transfer From Car to Car by Same Owner. Upon proof to the City Clerk that a vehicle for which a permit has been issued will not be used as a taxicab, the Clerk, without fee, may by the proper notation on said permit, transfer the same to any other taxicab owned by the permit holder, provided that the taxicabs to which the permit is to be transferred meets all requirements of inspection as hereinafter provided.

CODE OF GENERAL ORDINANCES, 2021 - KENOSHA, WISCONSIN

In the event a taxicab becomes unsafe or temporarily inoperative for need of repairs or lubrication the owner may transfer with the approval of the Police Department the card mentioned in ¶3. of C. above to another taxicab for a period of not exceeding thirty (30) days; and provided the substitute vehicle has received police inspection and found safe within 30 days prior to the substitution.

D. Regulations.

1. Inspection and Reports. Taxicabs are subject to the inspection and reporting requirements hereinafter set forth.

Taxicabs shall, at the cost and expense of applicant/permit holder, be inspected by an Automotive Service Excellence (A.S.E.) Certified Technician, who shall fill out, date and sign a Safety and Maintenance Inspection Checklist found in **Appendix 13.07 D.1.** of this Ordinance and provide a copy of their certification. The report shall be filed with the City Clerk/Treasurer at the following intervals: with the permit application, six (6) months after the permit was issued; after the taxicab was involved in an accident and damaged to any extent and prior to the taxicab being placed back into service; and at any time directed by the Police Chief or designee thereof, based upon personal observation of a police officer indicating a lack of required maintenance.

The permit holder must provide written notice to the City Clerk/Treasurer of any of the following occurrences within three (3) working days of having knowledge of the occurrence:

- A conviction of a permit holder for a violation of any State law or local Ordinance arising out of taxicab operation;
- Any driver's license suspension, revocation or restriction on a permit holder, whether or not related to taxicab operation;
- Any death or personal injury, or property damage caused by a permit holder and arising out of taxicab violation;
- Any death or personal injury, or damage or theft of personal property to a passenger in a taxicab operated by a permit holder;
- Any violation of a State law or local Ordinance by a permit holder, whether or not arising out of the operation of a taxicab, involving an offense against person or property, or an offense involving alcohol beverages, controlled substances, prostitution or gambling.

A taxicab may not be put in service until the required Safety and Maintenance Inspection has been completed, the taxicab has been rated as satisfactory, and the report has been timely filed with the City Clerk/Treasurer. Each day of noncompliance shall be a separate violation of this Ordinance, and shall subject the permit to revocation, nonrenewal or suspension.

The permit holder, for the full period of operation of each taxicab, shall keep a written record, with invoices, dated and signed, documenting work, respecting all maintenance work and accident repair work. These written records shall be made immediately available by the permit holder for inspection and copying upon request of the Kenosha Police Department or City Attorney's Office.

The Police Department may placard and order taken out of service any taxicab which has not been timely inspected, satisfactorily passed the safety inspection, and been documented as such with documents filed in the office of the City Clerk/Treasurer.

2. Identification. Every taxicab shall be conspicuously and legibly marked on both sides of the vehicle with the name of the owner, together with the owner's cab number in letters and numbers not less than two and one-half (2-1/2) inches in height and in color contrasting with the color of the vehicle.

CODE OF GENERAL ORDINANCES, 2021 - KENOSHA, WISCONSIN

E. Expiration, Renewal Lapse, Transfer of Permits, Surrender, and Cancellation.

1. All permits issued hereunder shall expire on the 30th day of June following their issue, and may be renewed upon payment of the fees hereinafter prescribed.

2. **Lapse of Permits.** Sixty-five (65%) percent of all Taxicab Permits must be in use as of June 30th of each year; 100 percent of all permits must be in use as of December 31st of each year. The Police Department shall ascertain on each of the above mentioned dates how many of such vehicles are in use or usable, and report the same to the Council at its next regular meeting. The Council without notice may revoke sufficient permits so that the above percentages will be met.

3. **Transfer of Permits.** No Taxicab Permit shall be transferred unless the permit holder is selling his entire taxicab business and all his or its taxicabs, and then only upon application to and with the permission of the City Council. If the Council permits the transfer, the purchaser shall pay to the City a fee of Twenty (\$20.00) Dollars per cab.

F. Revocation of Permits. The City Clerk shall revoke any permit upon notification from the Police Department that the vehicle is unfit and unsafe for use as a vehicle. Council may for cause revoke any permit hereunder.

G. Driver's License.

1. **Qualifications.** Every person driving a taxicab shall be licensed as such. Each applicant for a driver's license must:

- a. Be 18 years of age or over.
- b. Be able to read and write the English language.
- c. Be neat and not addicted to the use of intoxicating liquors.
- d. Give such information in writing as may be required by the Police Department, all of which shall be filed with the City Clerk as a permanent record.
- e. Have a valid Wisconsin Driver's License except in the case of an applicant who is a member of a branch of the Armed Services; then said applicant must have a valid Driver's License from the State which he declares as his residence, and must be residing within Kenosha County while in service.

It shall be a violation of this Ordinance for any individual to drive a taxicab without possessing a State issued driver's license, in good standing, valid in the State of Wisconsin, even if such individual is licensed by the City, and each day of operating a vehicle without a State issued driver's license, in good standing, valid in the State of Wisconsin shall be deemed to be a separate violation. It shall further be a violation of this Ordinance for any taxicab company to employ or lease a cab to a driver who does not possess, in good standing, a State issued driver's license valid in the State of Wisconsin and each day that a taxicab company shall permit a taxicab to be driven by a driver who does not have, in good standing, a State issued driver's license valid in the State of Wisconsin shall be deemed to be a separate violation.

2. Issuance of License.

- a. The City Clerk shall present all applications together with a report and recommendation of the Police

CODE OF GENERAL ORDINANCES, 2021 - KENOSHA, WISCONSIN

Department to the Council who shall either grant or deny the license. If the Council shall grant the license, the City Clerk shall issue a license along with a copy of this Ordinance to the applicant. The license shall bear the name, address, age, signature and photograph of the applicant. Every driver licensed under this Ordinance shall post his driver's license in such a place as to be in full view of all passengers while such driver is operating a taxicab. In the event of the revocation or other termination of the license, the license shall be returned to the City Clerk.

b. Upon the applicant's request, the City Clerk may issue a temporary taxi driver's license to any applicant who has been a resident of Kenosha County for five (5) years immediately prior to filing their application, who qualifies under Section 13.07 G.1. of this Ordinance, and who has two (2) or fewer convictions for Speeding 1-10 miles per hour over the limit within five (5) years of the date of the application. Any other convictions for traffic or nontraffic violations shall disqualify the applicant for a temporary taxi driver's license.

3. Fee and Term. The fee for such drivers license shall be Twenty (\$20) Dollars for the original license and Fifteen (\$15) Dollars for each annual renewal thereafter. For the license term commencing May 1, 2003, the fee for such drivers license shall be Thirty (\$30.00) Dollars for the original license and Thirty (\$30.00) Dollars for each annual renewal thereafter. The license shall expire on the April 30th next following its issuance. To renew a license, the same procedure shall be required as is required for the original license.

4. Regulation of Drivers and Rates of Fares.

a. **License, Ordinance Exhibited.** Each licensed driver shall upon demand of a police officer exhibit his/her license and a copy of this Ordinance for inspection.

b. **Obstructing Traffic.** No driver shall operate his vehicle in such manner as to unduly obstruct traffic or to constitute a nuisance to other vehicles and pedestrians.

c. **Attendance on Vehicles.** Every driver shall remain in his cab or immediately adjacent to his cab while the same is parked or standing on stand.

d. **Solicitation.** No driver shall solicit passengers at the usual stopping place of trackless trolleys and gasoline buses.

e. **Paratransit Service.** Drivers shall not be obligated to give individual service to the patron who first engages the taxicab. Drivers are permitted to provide paratransit service to as many passengers as the taxicab will safely allow.

f. **Disputed Fares.** Drivers shall submit all disputes as to fares to the officer in charge of the police station. The City Council, may, in their discretion, revoke the license of any driver found guilty of overcharging passengers.

g. **Refusal to Carry Passengers.** No driver shall refuse to convey a passenger to any destination requested by said passenger within the City Limits of Kenosha, Wisconsin.

h. **Rates and Fares.** No person, firm or corporation holding a Taxicab Permit shall charge for passengers picked up from and/or delivered to a location within the City of Kenosha, more than the advertised and posted rates established by the Permit holder. Rates shall be calculated by taking a base or "curb fare", for each zone on the Zone Map, which shall be a minimum fare established by the Permit holder, and adding a "zone fare", which shall be a consistent amount, also to be determined by the Permit holder, to be added for **each new zone entered**, after leaving the point of origin (pickup). Fare zones are established as shown and depicted on the Zone Map of the City of Kenosha appended to this Section, a copy of which is on file in the Office of the City Clerk/Treasurer. Permit holders shall charge for trips beyond the above described zones

CODE OF GENERAL ORDINANCES, 2021 - KENOSHA, WISCONSIN

according to a schedule of rates which shall also be on file with the City Clerk/Treasurer's Office.

Extra passengers, picked up and discharged at same location, may be charged according to the following schedule:

- 12 years of age and older. \$1.00
- Under 12 years of age. \$0.75
- Infants - Nil

Permit holders shall be authorized to charge an additional One (\$1.00) Dollar for an extra stop for a passenger not over one block off the direct route and not over three minutes waiting time.

There may be an added charge of Two (\$2.00) Dollars by the driver for parcel pickup. An added charge of Two (\$2.00) Dollars may be charged for delivery. An additional One (\$1.00) Dollar may be charged if the passenger requests the parcels, bundles or groceries to be carried beyond the door.

Permit holders shall be authorized to charge not in excess of Twenty (\$20.00) Dollars per hour or \$0.25 per minute after the first three minutes of waiting.

Areas annexed to the City after the passage of this Ordinance not located within one of the zones shall retain the "County Rates", fare amounts filed with the City Clerk/Treasurer.

All rates specified above are the maximum rates which shall be charged, and there shall be no minimum rates established by this Ordinance. Permit holders may provide the City Clerk/Treasurer with a minimum of two (2) working days notice of any proposed change in rates of fare for "curb" fare and/or for each zone entered.

Rates of fare shall be posted in all vehicles used to provide taxi services in a conspicuous place and manner. Passengers calling to request taxicab service shall be quoted a maximum rate for the requested service at the time of the call. All passengers shall be provided with a written or printed receipt for taxicab services upon demand. Permit holders may have a policy requiring prepayment.

The rate structure established under this Section shall not apply to contract health care providers (i.e., specialized medical vehicles), or service providers operating under any program of the Federal, State or local government to provide transportation services to persons with impaired driving ability.

5. Policy & Procedure For Disciplinary Actions Relative To Taxi Driver's License.

a. Definitions.

- (1) **LICENSE** means a Taxi Driver's License authorized under this Section 13.07.
- (2) **LICENSEE** shall mean the holder of a License.
- (3) **COMMITTEE** shall mean the Committee on Licenses/Permits.

b. License Investigations. The following may initiate requests for investigations before the Committee which may result in orders, suspensions, nonrenewals, delays in License issuance or revocation:

The Mayor;
The Common Council;
The Committee;
The State of Wisconsin;
An Alderman;

CODE OF GENERAL ORDINANCES, 2021 - KENOSHA, WISCONSIN

The Police Chief;
The City Attorney; and,
Any resident of the City of Kenosha.

Requests for investigations shall contain a brief statement of the alleged misconduct. The request shall be forwarded by the requesting party to the City Clerk who shall place said request on the Common Council Agenda for referral to the Committee or directly on the Committee Agenda with the permission of the Committee Chairperson. The City Clerk or the Committee Secretary shall order the Licensee to attend the Committee meeting at which said matter will be reviewed. Documents which form a basis for a request for an investigation shall be available for the inspection of the Licensee.

The Committee may reconsider any evidence or argument presented or made before it, whether or not obtained in or related to the written request for an investigation.

The Committee, upon requesting and receiving a recommendation from the City Attorney's Office, shall recommend to the Common Council:

- (1) That no action be taken;
- (2) That the License shall be suspended, not renewed or revoked following Statutory notice and opportunity to be heard, where the criteria for such action in Subsection D. is met;
- (3) That an order be issued and served upon the Licensee requiring that certain action be taken as a condition of maintaining said License and providing notice that revocation may be the penalty for failure to strictly comply with the letter and spirit thereof.

The Committee shall have the obligation of notifying the Licensee of any further proceedings before the Common Council.

The Common Council may affirm, deny or modify any recommendations of the Committee.

c. License Review Upon Renewal Application. Any License which is the subject of renewal shall, prior to License expiration, be reviewed in accordance with the procedure for License investigation contained in Subsection B., and in accordance with such additional procedures as the Committee may require. License renewal applications which are granted, shall be granted subject to applicable demerit points, if any.

d. Criteria For License Revocation, NonRenewal Or Suspension. Any Licensee who within any 730 day period, equals or exceeds a total of one hundred (100) demerit points for the below described conduct committed by Licensee, whether or not charged and/or convicted, shall have their License subject to revocation, nonrenewal or suspension, within the discretion of the Common Council.

- (1) **Ten (10) Points.** Violations of Chapter 347, Wisconsin Statutes, except for violations of §§347.35, 347.36, 347.486 through 347.489.
- (2) **Twenty (20) Points.**
 - (a) Violations of Chapter 343, Wisconsin Statutes, except for §343.44.
 - (b) Violations of Chapter 346, Wisconsin Statutes, except for §§346.62 through 346.73 or 346.57 where it is alleged that Licensee exceeded the speed limit by greater than ten (10) miles per hour.

CODE OF GENERAL ORDINANCES, 2021 - KENOSHA, WISCONSIN

- (c) Violations of Chapters 7, 11, 13, or 23 of the Code of General Ordinances for the City of Kenosha, not specifically scheduled elsewhere in this demerit scale.
 - (d) Violations of Administrative Code MVD-5.
 - (e) Violations of §943.24, 943.50 or Chapter 947, Wisconsin Statutes.
- (3) **Forty (40) Points.** Violations of §346.57, Wisconsin Statutes, where it is alleged that the Licensee exceeded the speed limit by more than ten (10) miles per hour, but less than twenty (20) miles per hour.
- (4) **Fifty (50) Points.**
- (a) Violations of §343.44, Wisconsin Statutes.
 - (b) Violations of §346.57, Wisconsin Statutes, where it is alleged that the Licensee exceeding the speed limit by more than twenty (20) miles per hour.
 - (c) Violations of §§346.68, 346.69, and 346.70, Wisconsin Statutes.
 - (d) Violations of Chapter 943, other than those specifically listed elsewhere in this schedule, or §§943.215, 943.25, 943.55, 943.60, 943.61, 943.62 and 943.70, Wisconsin Statutes.
- (5) **Seventy-five (75) Points.**
- (a) Violations of §346.63(1), Wisconsin Statutes, [1st offense in five (5) years.]
 - (b) Violations of §346.04(3), Wisconsin Statutes, [Fleeing].
- (6) **One Hundred (100) Points.**
- (a) Violations of §346.63(1), Wisconsin Statutes, [2d or subsequent offense with a five (5) year period as calculated by statute.]
 - (b) Violations of §346.63(2), Wisconsin Statutes, [Causing Injury by Intoxicated Use].
 - (c) Violations of §346.67, Wisconsin Statutes, [Hit and Run to an Attended Vehicle].
 - (d) Violations of Chapter 940, Wisconsin Statutes, except §§940.04, 940.07, 940.12 and 940.15.
 - (e) Violations of Chapter 941, Wisconsin Statutes, except §941.34.
 - (f) Violations of Chapter 943, Wisconsin Statutes, except §§943.012, 943.02-943.06, 943.10 and 943.34.
 - (g) Violations of Chapter 161, Wisconsin Statutes.
 - (h) Violations of Federal criminal law circumstances of which the charge substantially relates to the licensed activity.
- (7) Any points which are assessed or assessable above shall be doubled if the violation occurred during the course of their employment.
- (8) **Discretionary Demerit Points.** Nonscheduled offenses shall be the subject of such number of demerit points as designed by the Common Council, within its discretion.
- (9) **Offenses Not Considered.** No offenses will be considered respecting new applications for demerit points if the date of the violation is more than five (5) years prior to the date of application, except a felony which is material to the licensed activity.
- (10) **Out-of-State Traffic Offenses.** Reported violations of companion statutes for out-of-state traffic offenses, which are substantially similar to those violations listed above, shall be assigned the same number of demerit points.
- e. Discretion Upon Review.** The Common Council is not mandated to revoke, not renew or suspend a License which is subject to revocation, nonrenewal or suspension based upon the criteria in

CODE OF GENERAL ORDINANCES, 2021 - KENOSHA, WISCONSIN

Subsection d. therefor, but may take such action as the circumstances warrant with due consideration for mitigating factors.

A dismissal of a criminal charge or civil forfeiture case which is also the subject of demerit points, shall not, as a matter of law, nullify said charge for the purpose of review herein due to the differing burdens of proof and procedural requirements.

f. Delay In License Issuance. Any person or party who performs a licensed activity without first having obtained a proper License, or who, during a period of license suspension, or who, after License revocation or nonrenewal, unlawfully engages in a licensed activity, shall be barred from applying for the required License for a period of six (6) months from the date of such offense.

g. New Licenses Granted Subject To Demerit Points. New Licenses may be granted subject to such number of demerit points as the Common Council, in its discretion, may deem appropriate, irrespective of the nature of the offense, where the Common Council has concern as to the moral character and business responsibility of the applicant, which is insufficient for License denial.

New Licenses, if granted, shall be subject to twenty-five (25) demerit points in the event a License application is filed in violation of §1.22 A. of the Code of General Ordinances respecting untrue, incorrect and/or incomplete application.

h. Time For Action. Disciplinary action need not be commenced and completed in the same License year as the offense occurred. Where disciplinary actions are not commenced and completed within a License term, a License shall be granted subject to a "NonRenewal Revocation Hearing", to be held as soon as practicable.

i. Disciplinary Hearings. Disciplinary hearings, including nonrenewal, suspension and revocation hearings, shall be held before the Committee, which shall submit a report to the Common Council, including Findings of Fact, Conclusions of Law and a recommendation as to what action, if any, the Common Council should take with respect to the License. The Committee shall provide complainant and the Licensee with a copy of the report. Either the Complainant or Licensee may make an objection, orally or in writing, to the report and shall have the opportunity to present arguments supporting the objection to the Common Council. The Common Council shall determine whether the arguments shall be presented orally or in writing, or both. If the Common Council, after considering the Committee's report and any arguments presented by the Complainant and Licensee, finds the complaint to be true, or if there is no objection to a report recommending a suspension, revocation or nonrenewal, the Licensee shall be suspended, revoked or not renewed as provided by law. If the Common Council finds the complaint untrue, the proceedings shall be dismissed without cost to the accused. The City Clerk shall give notice of each suspension, revocation or nonrenewal to the party whose License is affected.

j. Judgment Of Conviction, As Prima Facie Proof Of Violation. The judgment of conviction of any Licensee, or employee or agent thereof, in any Municipal, State or Federal Court, irrespective of whether obtained following trial, plea agreement, or bond forfeiture, shall be prima facie proof of said violation for purposes of this Ordinance. However, in the instance of any judgment of conviction entered pursuant to a no contest plea, or considered in law to be rendered pursuant to a no contest plea, said judgment of conviction as a prima facie case may be rebutted. Further, mitigating circumstances may be introduced with respect to any judgment of conviction.

k. Application For Determination Of Demerit Points. Any Licensee or party entitled to initiate a request for an investigation under Subsection B. hereof, may, at any time, request the Common Council to determine whether or not conduct which has occurred constitutes a basis for demerit points, and, if so, how many demerit

CODE OF GENERAL ORDINANCES, 2021 - KENOSHA, WISCONSIN

points. The Common Council, in making this determination, shall have before it the recommendation of the Committee and of the City Attorney's Office.

I. Commencement Of Penalties. Penalties shall commence the day after they have been imposed by the Common Council. Days of suspension shall run consecutively.

m. Periodic Reports By Police Chief. The Police Chief shall file periodic reports with the City Attorney advising said City Attorney of conduct by any Licensee, or employees thereof, which may constitute a basis for disciplinary action. The City Attorney, at Licensee renewal time, or at any earlier time deemed appropriate, shall bring such matters to the attention of the Committee and make a recommendation on disciplinary action.

H. Hours of Service. All persons, firms, associations or corporations holding a Taxicab Permit shall offer continuous telephone service for twenty-four (24) hours each day.

13.08 TAXICABS FROM OTHER JURISDICTIONS

A. Prohibition. No taxicab, as defined in §13.07 A., of the Code of General Ordinances, not licensed by the City of Kenosha under §13.07 of the Code of General Ordinances shall:

1. Solicit taxicab passengers on a fee basis within the City or;
2. Accept for transportation, on a fee basis, any passengers destined to the municipality in which such taxicab is licensed and then only when such transportation has been arranged for in advance by telephone or written order.

B. Nothing in this Ordinance shall be construed to prohibit any taxicab licensed by another municipality from coming into the City to discharge passengers accepted for transportation outside of the City limits. However, while said taxicab, licensed by another municipality, is in the City, no light or sign shall be used to indicate that said taxicab is subject for hire within the City. Further, while in the City said taxicab shall have displayed at or near the vehicle's windshield a sign printed in English, in block letters not less than two (2) inches in height, indicating "Not for Hire".

13.09 TOBACCO SALES

A. Definitions in this Section:

"Cigarette" - "Cigarette" means any roll of tobacco wrapped in paper or any substance other than tobacco.

"Distributor" - "Distributor" means any of the following:

1. Any person who acquires unstamped cigarettes from the manufacturer thereof, affixes stamps to the packages or other containers, stores them and sells them to other permittees or to retailers for resale. He or she may also acquire stamped cigarettes from another permittee for such sales;
 2. Any person engaged in the business of selling tobacco products in this State who brings, or causes to be brought into this State from outside the State any tobacco products for sale;
 3. Any person who makes, manufactures or fabricates tobacco products in this State for sale in this State;
- or,

CODE OF GENERAL ORDINANCES, 2021 - KENOSHA, WISCONSIN

4. Any person engaged in the business of selling tobacco products outside this State who ships or transports tobacco products to retailers in this State to be sold by those retailers.

"Identification Card" - "Identification Card" means any of the following:

1. A license containing a photograph issued under Chapter 343, Wisconsin Statutes; or,
2. An identification card issued under §343.50, Wisconsin Statutes; or,
3. An identification card issued under §125.08, Wisconsin Statutes.

"Jobber" - "Jobber" means any person who acquires stamped cigarettes from manufacturers or distributors, stores them and sells them to retailers for resale.

"Manufacturer" - "Manufacturer" means any of the following:

1. Any person who manufactures cigarettes for the purpose of sale; or,
2. Any person who manufactures and sells tobacco products.

"Retailer" - "Retailer" means any person licensed pursuant to Subsection B. herein.

"School" - "School" has the meaning given in §118.257(1) (c), Wisconsin Statutes.

"Subjobber" - "Subjobber" means any person other than a manufacturer or distributor, who buys tobacco products from a distributor and sells them to a person other than the ultimate consumers.

"Tobacco Products" - "Tobacco Products" means cigars; cheroots; stories; periques; granulated, plug cut, crimp cut, ready-rubbed and other smoking tobacco; snuff; snuff flour; cavendish; plug and twist tobacco; fine cut and other chewing tobaccos; shorts; refuse scraps, clippings, cuttings and sweepings of tobacco and other kinds and forms of tobacco prepared in such manner as to be suitable for chewing or smoking in a pipe or otherwise, or both for chewing and smoking; but "tobacco products" does not include cigarette as defined under "cigarette".

"Vending Machine" - "Vending Machine" is any mechanical device which automatically dispenses cigarettes upon the deposit therein of specified coins in payment for such cigarettes.

"Vending Machine Operator" - "Vending Machine Operator" means a person who acquires stamped cigarettes from manufacturers or permittees, stores them and sells them through the medium of vending machines which he or she owns, operates or services and which are located on premises which are owned or under the control of other persons.

B. Cigarette and Tobacco Products Retailer License.

1. No person shall in any manner, or upon any pretense, or by any device, directly or indirectly sell, expose for sale, possess with intent to sell, exchange, barter, dispose of or give away any cigarettes or tobacco products to any person not holding a license as herein provided or a permit under Sections 139.30 to 139.41 or 139.79, Wisconsin Statutes, without first obtaining a license from the City of Kenosha or being employed by a Cigarette and Tobacco Products Retailer Licensee while on the licensed premises.

2. Upon filing of a proper written application, a license shall be issued on July 1 of each year or when applied for and continue in force until the following June 30, unless sooner revoked.

3. Each such license shall name the licensee and specifically describe the premises where such business

CODE OF GENERAL ORDINANCES, 2021 - KENOSHA, WISCONSIN

is to be conducted. Such licenses shall not be transferable from one person to another, nor from one premises to another.

4. The annual license fee shall be One Hundred (\$100.00) Dollars per license year or part of a license year. The fee is not prorated.

5. Every licensed retailer shall keep complete and accurate records of all purchases and receipts of cigarettes and tobacco products. Such records shall be preserved on the licensed premises for two (2) years in such a manner as to insure permanency and accessibility for inspection and shall be subject to inspection at all reasonable hours by authorized State and local law enforcement officials.

C. Restrictions.

1. No retailer, manufacturer, distributor, jobber or subjobber, no agent, employee or independent contractor of a retailer, manufacturer, distributor, jobber or subjobber and no agent or employee of an independent contractor may sell or provide for nominal or no consideration cigarettes or tobacco products to any person under the age of eighteen (18), except as provided in Section 938.983(3), Wisconsin Statutes. A vending machine operator is not liable under this paragraph for the purchase of cigarettes or tobacco products from his or her vending machine by a person under the age of eighteen (18) if the vending machine operator was unaware of the purchase.

2. No retailer, manufacturer, distributor, jobber, subjobber, no agent, employee or independent contractor of a retailer, manufacturer, distributor, jobber or subjobber and no agent or employee of an independent contractor may provide for nominal or no consideration cigarettes or tobacco products to any person except in a place where no person younger than eighteen (18) years of age is present or permitted to enter unless the person who is younger than eighteen (18) years of age is accompanied by his or her parent or guardian or by his or her spouse who has attained the age of eighteen (18) years.

3.a. A retailer shall post a sign in areas within his or her premises where cigarettes or tobacco products are sold to consumers stating that the sale of any cigarette or tobacco product to a person under the age of eighteen (18) is unlawful under this Section and Section 938.983, Wisconsin Statutes.

b. A vending machine operator shall attach a notice in a conspicuous place on the front of his or her vending machines stating that the purchase of any cigarette or tobacco product by a person under the age of eighteen (18) is unlawful under this Section and Section 938.983, Wisconsin Statutes, and that the purchaser is subject to a forfeiture of not to exceed Twenty-five (\$25.00) Dollars.

4.a. A retailer or vending machine operator may not sell cigarettes or tobacco products from a vending machine unless the vending machine is located in a place where the retailer or vending machine operator ensures that no person younger than eighteen (18) years of age is present or permitted to enter unless he or she is accompanied by his or her parent or guardian or by his or her spouse who has attained the age of eighteen (18) years.

b. Notwithstanding Subsection 4.a., no retailer may place a vending machine within five hundred (500') feet of a school.

5. No manufacturer, distributor, jobber, subjobber or retailer, or their employees or agents, may provide cigarettes or tobacco products for nominal or no consideration to any person under the age of eighteen (18).

6. No retailer may sell cigarettes in a form other than as a package or container on which a stamp is affixed under Section 139.32(1), Wisconsin Statutes.

CODE OF GENERAL ORDINANCES, 2021 - KENOSHA, WISCONSIN

D. Defense of Retailer, Manufacturer and Distributor. Proof of all of the following facts by a retailer, manufacturer or distributor who sells cigarettes or tobacco products to a person under the age of eighteen (18) is a defense to any prosecution for a violation of Subsection C.1.:

1. That the purchaser falsely represented that he or she had attained the age of eighteen (18) and presented an identification card.
2. That the appearance of the purchaser was such that an ordinary and prudent person would believe that the purchaser had attained the age of eighteen (18).
3. That the sale was made in good faith, in reasonable reliance on the identification card and appearance of the purchaser and in the belief that the purchaser had attained the age of eighteen (18).

E. Possession of Cigarettes or Tobacco Products By Minors.

1. Except as permitted in Subsection C.2., no person under eighteen (18) years of age may do any of the following:
 - a. Buy or attempt to buy any cigarette or tobacco product.
 - b. Falsely represent his or her age for the purpose of receiving any cigarette or tobacco product.
 - c. Possess any cigarette or tobacco product.
2. A child may purchase or possess cigarettes or tobacco products for the sole purpose of resale in the course of employment during his or her working hours if employed by a retailer licensed herein.
3. A law enforcement officer shall seize any cigarette or tobacco product involved in any violation of Subsection E. committed in his or her presence.

13.10 CHRISTMAS TREES

A. License. No person, firm, or corporation shall open, maintain, operate or conduct any place for the purpose of storing, selling or displaying for sale any Christmas trees until he first shall have applied for and secured a license so to do at the location specified in such license.

B. Definitions. For the purpose of this Ordinance, words and phrases shall remain as follows: **Christmas Trees** shall mean those trees of the varieties and kinds used for decorative purposes, usually during the Christmas season, and which have been cut and no longer attached to the soil; **public street** shall mean all that property set aside for street purposes or street right-of-ways, and shall include sidewalks, curbs, shoulders, parking strips and alleys.

C. License Fee. The license fee shall be the sum of Fifty (\$50.00) Dollars. Said license shall be valid only to the 3rd day of January following its issue. Each location at which Christmas Trees are stored, displayed or sold shall require a separate license. No license shall be transferable either to person or person or place to place.

D. Application. Applications for license shall not be received by the City Clerk after December 1 in any year, and shall be made upon forms furnished by the City Clerk and give applicants name, residence, usual business, and the name of the owner of the premises for which a license is sought. The license fee and deposit required in Paragraph F. below shall accompany the application. No license shall be issued except upon the approval of the Fire Department.

CODE OF GENERAL ORDINANCES, 2021 - KENOSHA, WISCONSIN

E. Regulations.

1. The license shall be prominently and at all times displayed on the premises licensed.
2. No Christmas trees shall be displayed, stored or sold on any public street.
3. All licensed premises shall be maintained in such manner as to eliminate, in so far as possible, any fire hazard.
4. No trees which have become dried out shall be kept on the premises.
5. At the expiration of the license or whenever the premises shall cease to be used further for the storage or sale of Christmas trees, the licensee shall cause all trimmings, cuttings, trees, and debris to be removed from said premises and disposed of in a lawful manner.

F. Deposit. As a condition precedent to the granting of a license the applicant shall deposit with the City Clerk the sum of \$40.00, which amount shall be returned to the licensee upon the expiration of such license and after the inspection of the premises by the Fire Department and certification by said department that the premises have been left in a clean condition and that no fire hazard exists thereon by reason of Christmas trees or parts thereof. If the licensee fails to properly clean the premises upon removal or fails to maintain the premises in a manner eliminating any fire hazard as necessary in the opinion of the Chief of the Fire Department, the Fire Department is authorized to enter upon said premises and remove or destroy or cause to be removed or destroyed such Christmas trees or parts thereof as may create a fire hazard and the cost of such removal shall be deducted from the amount placed on deposit with the City Clerk.

If the applicant is engaged in an established and permanent business in Kenosha and has paid personal property taxes due in the year of his application, the Mayor may waive the above mentioned deposit. Such waiver, however, shall not relieve the licensee from compliance with other provisions of this Ordinance, and he shall be obligated to reimburse the City for all cost in cleaning the premises and removing fire hazards as hereinbefore provided.

G. Revocation. The Mayor may cancel or revoke any license if, in his opinion, any of the provisions of this Ordinance have been violated. Any licensee, whose license has been revoked, shall have the right to a hearing before the City Council by application therefor within five days after notice that such license has been revoked.

13.11 FARMER MARKETS

A. Establishment of Farmer Markets. Farmer Markets for the City of Kenosha shall be and are hereby established at such public places as may be determined by the Council, during the period of June 1 through November 30.

B. Use of Market. By Whom. No person shall sublet or transfer his space or stall so rented to such person to any other party, and no person shall have any use whatever of any such stall or space except the party purchasing the same or his employees; and no person shall use any of the public streets, alleys, or other public places in said City as standing places for teams, wagons, or automobiles, for the sale of fruits, vegetables or other products usually disposed of in market places, except those portions of streets, or alleys that the Committee on Public Welfare may designate. Nothing herein contained however shall prohibit licensed hucksters from peddling from house to house within the City. No person shall have a right to use said markets without complying with the provisions of this Chapter and with the rules and regulations that may from time to time be made in relation to the same as in this Chapter provided for.

CODE OF GENERAL ORDINANCES, 2021 - KENOSHA, WISCONSIN

C. Superintendent of Markets. The City Sealer shall be the Superintendent of Markets and as such shall have full administrative jurisdiction and control of Farmer Markets and full authority to enforce this Section (13.11).

D. Rental Fee For Stalls. The rental fee for each eight (8) foot stall shall be at the rate of Four (\$4) Dollars per diem and shall be limited to three (3) stalls per family at each of the market places.

E. Assignment of Stalls. All farmers wishing to rent a stall at any of the market places from June 1 through October 31 must make application therefor to the Superintendent of Markets. The rental fee for a term from June 1 through October 31 shall be Fifty (\$50) Dollars per stall to be paid between January 1 and June 1. The rental fee from October 31 through November 30 shall be One (\$1) Dollar per diem.

All renewals for stalls must be made by May 1 after which stalls will be declared vacant and available for rent to others.

All stalls not designated by an (X) may be rented for the daily fee.

Any leased stall not occupied by 9 A.M. may be sublet for the balance of the day to regular or seasonal renters as the Superintendent of Markets may decide.

F. Market Hours. The starting time shall be 6:00 A.M. and the closing time shall be 12:00 noon except on Saturdays the closing time shall be 1:00 P.M. No person shall display any wares or produce before said opening hour nor after the hour set for closing.

G. Cleaning of Stalls. The littering of the grounds at said market is hereby prohibited and the owner or seller of each load is required to pick up and remove from the ground all paper, refuse or anything whatsoever lying upon the ground as the result of his use thereof before he leaves the market. The Superintendent shall have the right to expel anyone from said market providing he finds that said person is attempting to sell produce which is not fit for use, or if said person is trying to wrongfully influence prices while on said markets.

H. Scales. All scales used by occupants of market stalls must be inspected and sealed by the City Sealer before put in use at any of the City markets.

I. Relocation of Permit or Denial of Use of Market. For the violation of any of the provisions of this Ordinance, the Superintendent may revoke the permit to use any stall or may deny the issuance of any future permit for one (1) year from date of violation. An appeal from such revocation or denial of permit may be had to the Committee on Public Welfare upon payment of Five (\$5) Dollars. Upon such appeal the Market Committee shall hold a public hearing thereon at which time all parties in interest may appear and give evidence.

J. Rules and Regulations. The Committee on Public Welfare together with the Superintendent shall from time to time make such necessary rules and regulations for the daily working and care of the markets as in their judgment may from time to time be necessary.

13.12 TOWING SERVICE

A. Purpose. Motor vehicles must, of necessity, be removed from public or private property at the request of the City Police Department without the owner's permission, where said vehicles: are disabled, are abandoned, constitute a public or private nuisance, are illegally parked, are evidence, are stolen, or are or were in the ownership or control of a prisoner or dead or disabled person who is unable to personally arrange for towing. The above service shall be known as "Class I Tows". Other motor vehicles which become disabled may

CODE OF GENERAL ORDINANCES, 2021 - KENOSHA, WISCONSIN

be operated by parties who need to have their vehicle towed but who have no preference for a tower. In such cases, the public convenience requires the Police Department to arrange for towing services. Such service shall be known as "Class II Tows". Further, the convenience of the City requires that disabled City vehicles be towed promptly upon request for a reasonable fee. Such service shall be known as "Class III Tows".

In order to effectuate the above, it is necessary for towers who tow at the request of the City Police Department to be licensed by the City to insure that all tows will be made by adequately insured towers, who operate safe and efficient tow trucks, and who possess sufficient equipment to be able to respond to the vast majority of all Police Department calls for towing service, irrespective of the degree of difficulty of the call. Licensing will insure that towers have a sufficient amount of equipment as will enable City licensed towers to service City interest concurrently with the service of private sector customers. Licensing will also insure that towers are in a position to and will accept all calls for service in order to provide efficient services and in order to prohibit any tower from skimming off only the most desirable business and that towers have adequate and reasonably safe storage areas which are conveniently accessible to City residents. Licensing will insure tower responsiveness to the needs of the City and of City residents.

B. Definitions. The following words, as used herein, shall mean:

1. **"Person"** shall be any party, person, firm, corporation, partnership, association or other legal entity.
2. **"Preference Tow"** shall mean any motor vehicle accident or disablement where a motor vehicle operator, requiring towing service, expresses a preference as to a named wrecker.
3. **"No Preference Tow"** shall mean any motor vehicle accident or disablement where a motor vehicle operator, requiring towing service, expresses no preference as to a named wrecker.
4. **"Wrecker"** shall mean one engaged in the business of or offering the services of a motor vehicle tower.
5. **"Licensee"** shall be one who has been issued a license by the Common Council under this Ordinance to perform towing services for or at the request of the City of Kenosha or its Police Department.
6. **"Tow"** shall mean to remove a motor vehicle from a given place, whether temporarily or permanently disabled, by use of a vehicle designed or customarily used for that purpose, to a place of storage pending the repair, salvage, recovery, sale or disposal of said vehicle.
7. **"Assignment"** shall mean a call or referral by or from the City or its Police Department to a wrecker requesting towing services hereunder licensed.
8. **"Storage lot"** shall mean premises which are subject to use, in accordance with local and state laws, rules and regulations, as a place to temporarily keep towed vehicles pending the final disposition thereof. Storage lots must be completely enclosed with a six (6) foot high fence which is of such a nature as will offer reasonable protection for vehicles and their contents against theft and or vandalism. Any side of the enclosing fence which is viewable from a public thoroughfare must be constructed in such a manner as will screen from view the vehicles stored within the fenced enclosure. The storage lot shall provide outside storage for a minimum of thirty (30) vehicles and inside storage for a minimum of two (2) vehicles. The storage lot shall be located at the wrecker's (licensee's) principal place of business.
9. **"Principal place of business"** shall mean the address which is listed in the telephone book or with the telephone company as the location at which business telephones are located, and it shall mean the place at which tow trucks are routinely kept when not in operation, and the location of the central business office.

CODE OF GENERAL ORDINANCES, 2021 - KENOSHA, WISCONSIN

10. "Class I, II and III Tows" - See Subsection A. of this Ordinance.

C. License Required. No person or wrecker shall engage in Class I, II and III tows within the City or at the request of the City, or its Police Department, without first having obtained a license therefor from the Common Council. Further, no person shall be assigned no preference tows without first being licensed hereunder. The acceptance of a license shall constitute a declaration and agreement of the licensee to perform licensed activities subject to the terms and conditions of this Ordinance. The acceptance of a license constitutes a commitment of the licensee to perform towing services hereunder and shall not be deemed a means of or authorize the business or practice of a designated licensee referring assignments to another license. A licensed tower may not relocate his principal place of business or storage lot without first obtaining the permission of the Common Council following review thereof by the Public Safety & Welfare Committee. City towing licenses may not be transferred or assigned without prior approval of the Common Council following review thereof by the Public Safety & Welfare and Finance Committees.

D. Application. Application for such license shall be made, in writing, to the City Clerk upon such forms as shall be prescribed by the City Clerk. The City Clerk, when the application is completed as herein specified, shall refer said application to the Finance Committee for recommendation, as soon as such referral is practicable. The applicant must provide the following information as a condition of said application being considered for approval: Name, legal existence if other than an individual; names of partners or associates, if a partnership or association; names of officers if a corporation; place of incorporation if a corporation; address of principal place of business and business phone number; distance from City limits proper of principal place of business if address is outside of the City limits; description of security for storage lot; number of vehicles which can be kept on storage lot; number of towing vehicles in service at time of application with their description, including gross vehicle weight, winch capacity and equipment, vehicle identification number and state motor vehicle license number of all towing vehicles. The application shall also contain a copy of any leases or agreements applicant may have for the use of a storage lot where applicant does not own such a lot and a copy of any leases for tow trucks. The applicant shall have the continuing responsibility to update all information herein requested as a condition of maintaining this license.

E. Standards for License Issuance. The Common Council and its licensing committee may not consider or grant a license to an applicant who does not meet the following minimum requirements:

1. Own or exclusively lease for the license period two (2) tow trucks - one (1) of which shall have a minimum four (4) ton winch capacity and one (1) of which shall have a minimum GVW of 12,000 pounds and a minimum eight (8) ton winch. As an alternative for the tow truck with a minimum GVW of 12,000 pounds and a minimum eight (8) ton winch a flat bed truck with a minimum GVW of 20,000 pounds and a minimum four (4) ton winch, with a compatible hydraulic combination of eight (8) tons, may be substituted. Each truck shall be equipped with a two-way commercial radio, lights and such other safety devices as will comply with Chapter 347, Wisconsin Statutes, a rubber tow sling, a dolly, 100 feet of tow cable, and equipment for cleaning up glass and debris at an accident scene. City assignments must be given top priority as a condition of holding a license.

2. Ownership of or exclusive lease for the license period of a storage lot as herein defined.

3. The principal place of business and storage lot must be within the City, or if outside of the City, within one (1) air mile of the City limits proper, excluding any City islands.

4. Execution of an indemnity and hold harmless agreement protecting the City from the payment of any claims for property damage, personal injury or death, and from all expenses, attorneys fees and court costs associated with said claims resulting from or arising out of the licensees operation under this Chapter, including, but not limited to, the towing and storage of vehicles.

CODE OF GENERAL ORDINANCES, 2021 - KENOSHA, WISCONSIN

5. An inspection certificate from the Chief of Police indicating that the applicant's storage lot meets the requirements of this Ordinance.

6. A licensed carrier authority from the State of Wisconsin.

7. Towing equipment which is adequate to perform towing services in a reasonable and workmanlike manner.

8. Certificates of insurance providing a minimum of ten (10) days written notice to the City before any such policy is amended or cancelled, which shows statutory worker's compensation for employees, insurance on the tow trucks written in comprehensive form, providing minimum limits of bodily injury liability and property damage liability, as required by the State of Wisconsin for obtaining carrier authority, and which shows protection of the City and the licensee against all claims arising from injuries to persons or damage to property of others arising out of any act or omission of the licensee or its agents, relative to performance of work for which the license is granted.

9. Proof of law enforcement authority from the State of Wisconsin, should said authority be provided for by the State.

F. Inspection. All towing vehicles shall be inspected, at the cost and expense of the applicant/license holder, by an Automotive Service Excellence (A.S.E.) Certified Technician, who shall fill out, date and sign a Safety Maintenance Certification in the form found in Appendix 13.12 F. of this Ordinance. Such inspection shall be completed not more than forty-five (45) days prior to the date of review of the license application by the Finance Committee. Proof of correction of all discrepancies noted in the Safety Maintenance Certification shall be submitted with the application. The license shall not be issued until all such discrepancies are corrected. The Police Department shall have authority to inspect any towing vehicle and/or towed vehicle at licensee's storage lot without notice during regular business hours and with reasonable notice at other times.

G. Employment Prohibition. Licensees shall not employ on a full or part time basis any law enforcement officer or any civilian employee of any law enforcement agency.

H. License Fee. The license fee shall be One Hundred (\$100) Dollars per year, paid at the time of application. License fees shall not be prorated.

I. License Year. All licenses shall expire on the 30th day of June of each year.

J. Standard Rate Schedule. Licensees shall maintain records of the amounts charged for tows and shall charge no more than the following rates for their services while towing for or at the request of the City:

1. Towing vehicles under 7,000 pounds: 8:00 A.M. to 6:00 P.M., Monday through Saturday, \$75; 8:00 A.M. to 6 P.M., Sundays and Holidays, \$85; 6:00 P.M. to 8:00 A.M., Monday through Saturday, \$85; 6:00 P.M. to 8:00 A.M. Sundays and Holidays, \$85. Towing vehicles over 7,000 pounds, the rate shall be the prevailing rate in the community.

2. Dollies, if required: \$25; **Flatbeds,** the base rate specified in Subsection 1. above, plus \$25.

3. Labor per man per hour, other than driver, 8:00 A.M. to 6:00 P.M., Monday through Saturday, \$30 with a \$15 minimum; 6:00 P.M. to 8:00 A.M., Sundays and Holidays, \$40 per hour with a \$20 minimum.

4. Winching, up-righting, shoveling, sweeping, waiting, 8:00 A.M. to 6:00 P.M., Monday through

CODE OF GENERAL ORDINANCES, 2021 - KENOSHA, WISCONSIN

Saturday, \$30 per hour with a \$15 minimum; 6:00 P.M. to 8:00 A.M., Sundays and Holidays, \$40 with a \$20 minimum.

5. Towing of City owned vehicles, 8:00 A.M. to 6:00 P.M., \$15; 6:00 P.M. to 8:00 A.M., and on Sundays and Holidays, \$25 without any additional charges.

6. Remove and replace transmission linkage, \$15.

7. For indoor storage, \$25 per day; **for outdoor storage**, \$20 per day, with a one (1) day minimum.

8. No charge to the City for towing junked or abandoned vehicles.

9. Vehicles which are towed pursuant to this Ordinance may be claimed at the storage lot upon which they are stored during regular business office hours, Monday through Saturday.

The vehicle owner or other party contracting or benefitting from said towing services shall be responsible to the tower for the charges specified in Subsections 1., 2., 3., 4., 6. and 7. above, and the City, or its employees or officers, shall not be charged or liable for said services, except as provided in Subsection 5. above.

K. Maintenance of Vehicles and Equipment. Vehicles used in towing operations shall be maintained in a safe and roadworthy condition and shall be equipped with well maintained towing equipment which is adequate to perform towing services in a reasonable and workmanlike manner.

L. Twenty-Four Hour Service. Towing service must be provided twenty-four (24) hours a day, each and every day of the year. The failure of a licensee to perform licensed services shall be grounds for revocation or suspension of this license. Any licensee who fails to respond to or accept three (3) calls during any license year shall be called before the Finance Committee and Common Council to explain said failure. If said failure is not justified, the licensee shall be put on probation for the balance of the license year. Any further failure to perform services during the same license year shall be grounds for suspension or revocation of this license.

M. Assignment by Rotation. Towing service, herein relevant, shall be on a rotation basis based upon three separate lists, one list for each Class of Tows: Class I, Class II and Class III. Each list shall contain the names of all licensees and assignments therefrom shall be administered by the City of Kenosha Police Department. Assignments shall be deemed waived by non-response or nonacceptance. Licensees may, under extraordinary circumstances, arrange for another licensee to fulfill their assignment.

N. Violations. Any wrecker who attempts to or who does influence the orderly rotation of assignments, or who otherwise violates the provisions of this Ordinance, shall be subject to revocation, termination or suspension of their license, following written notice of a hearing containing a statement of the complaint made against the licensee and the name of the party requesting the hearing, and a hearing before the Finance Committee, with the recommendation of the Finance Committee being submitted to the Common Council for final action thereon. A hearing shall be held upon the request of the Chief of Police, City Attorney, Chairman of the Finance Committee or Chairman of the Public Safety & Welfare Committee following a preliminary investigation by either of them indicating that a complaint which has been brought to their attention has merit or is worthy of a full investigation.

O. Hours of Towing for City. Licensees shall not be required to move junked or abandoned vehicles from public or private property except during daylight working hours, 7:00 a.m. to 5:00 p.m., Monday through Saturday, unless such vehicle is creating an immediate hazard.

CODE OF GENERAL ORDINANCES, 2021 - KENOSHA, WISCONSIN

P. Personal Belongings in Towed Vehicle. Section 349.13 (5)(b), Wisconsin Statutes, is incorporated herein by reference.

Q. Supervision. The Committee on Public Safety & Welfare shall have jurisdiction to adjust disputes and promulgate rules and regulations which will effect the efficient and just operation of this Ordinance. A copy of any rules and regulations promulgated hereunder shall be open to public inspection at the Office of the City Clerk and at the Police Department.

R. Temporary Licenses. In the event of emergency circumstances requiring temporary towing capacity over and above the towing capacity available through existing licensed "wreckers", the Chairman of Safety & Welfare may grant one or more temporary licenses, for a period not to exceed ten (10) days, for "Class I" and "Class III Tows". The fee for such a license shall be Ten (\$10) Dollars. The provisions of this Ordinance shall apply to such temporary licenses, however, the Chairman of Safety & Welfare may waive the storage lot requirement of this Ordinance, the requirement of this Ordinance providing for a minimum number of tow trucks, and the requirement of this Ordinance providing that the principal place of business and storage lot be within the City, or if outside of the City, within one (1) air mile of the City limits proper, excluding any City islands, when said waiver is required in order to obtain adequate temporary towing capacity. When temporary licenses are issued, they shall be filed with the City Clerk and a notice of the issuance thereof shall be sent to the Mayor and Common Council.

S. Determination of Need.

1. Finding. The Common Council of the City of Kenosha finds that on the effective date of this Ordinance that:

- a. Towing services are being adequately performed in the City by the City licensed wreckers.
- b. The granting of towing licenses over and above the actual need therefor will result in a deterioration of towing services in the City as a given volume of towing business is required to enable licensees to finance the high quality of equipment, facilities and services required under this Ordinance.
- c. The licensing of wreckers over and above need will create problems in the administration and enforcement of this Ordinance, creating unnecessary expense for the City and providing a potential for a deterioration of towing services in the City.

2. Additional Licenses. No towing license applications will be accepted or processed under this Ordinance unless the Common Council first finds and determines that the then licensed towers are unable or unwilling to provide for the quantity and quality of towing service which is required to serve the needs of the City. Any wrecker who is otherwise able to comply with this Ordinance may request the Common Council to hold a hearing on the requirement of "need". However, such a hearing will not be held unless the wrecker requesting such a hearing alleges that the factors dictating need on the effective date of this Ordinance have materially and substantially changed thereafter.

This Ordinance shall become effective upon passage and publication. Existing licensees need not be relicensed prior to July 1, 1983. Existing licensees will have until July 1, 1983, to meet equipment and storage lot requirements hereunder. New licensees will have until July 1, 1983, to fence their storage lot.

13.125 MESSAGE ESTABLISHMENTS

A. It shall be unlawful for any person, corporation or other legal entity to suffer, cause or permit the operation of a massage establishment or for a person to engage in the practice of massage therapy or

CODE OF GENERAL ORDINANCES, 2021 - KENOSHA, WISCONSIN

body work or perform massage therapy of body work for gain as a massage therapist, bodywork therapist, agent, manager or employee, except in strict compliance with this section.

1. Definitions. For the purposes of this section:

a. **"Massage"** or **"bodywork"** means the science and healing art that uses manual actions and adjunctive therapies to palpate and manipulate the soft tissue of the human body in order to improve circulation, reduce tension, relieve soft tissue pain, or increase flexibility. "Massage therapy" or "bodywork therapy" includes determining whether manual actions and adjunctive therapies are appropriate or contraindicated, or whether a referral to another health care practitioner is appropriate. "Massage therapy" or "bodywork therapy" does not include making a medical, physical therapy, or chiropractic diagnosis.

b. **"Intimate parts"** shall mean the breasts, buttocks, anus, groin, scrotum, penis, vagina, or pubic mound of a human being.

c. **"Massage establishment"** means a place of business having a permanent location wherein private massage or bodywork is practiced, used or made available.

d. **"Massage therapist"** or **"bodywork therapist"** means a person licensed by the State of Wisconsin pursuant to Wisconsin State Statute, who practices, administers or uses or offers to practice, administer or use massage or bodywork for a consideration.

e. **"Patron"** means any person who receives a massage or bodywork under such circumstances that it is reasonably expected that he or she will pay money or give any consideration therefore.

f. **"Operator"** means any person, association, firm, partnership or corporation licensed by the City to operate a massage establishment.

g. **"Manager"** means the operator or an agent licensed under this section who shall not be licensed as a massage or bodywork technician.

h. **"Waiting area"** means an area adjacent to the main entrance that is separate from any area where massages or bodywork are given.

i. **"Massage room"** means the area where private massage or bodywork is performed.

B. Massage Establishment License.

1. **License Required.** No person, corporation, or other legal entity shall suffer, cause or permit the conduct of a massage establishment without having first obtained a license therefore from the Common Council. A separate license shall be acquired for each such establishment.

2. **Term.** The license term shall be January 1, through December 31.

3. **Fee.** The license fee shall be \$100.00. License fees shall be nonrefundable and shall be prorated for the license term. The application must be accompanied by payment of the License fee or upon such portion of the fee as the number of months, or fraction of a month, remaining until December 31st of each year.

4. No license shall be granted for any establishment, the main entrance to which is within seventy-five (75) feet of the main entrance to a residence or of the common entry hall to residences, nor for any room or rooms in any hotel or motel, unless the establishment occupancy predates the creation of this ordinance.

5. Applications shall be made in writing on forms supplied by the City Clerk. If application is made for a location not previously licensed, the City Clerk shall, by regular mail, notify all property owners and registered electors within two hundred fifty (250) feet of the proposed location. Said notice shall inform the addressee of dates, times and locations of the License/Permit Committee meeting and Common Council meeting where the matter of the application shall be discussed.

CODE OF GENERAL ORDINANCES, 2021 - KENOSHA, WISCONSIN

6. All applications shall include:
- a. The License fee.
 - b. The location and mailing address of the proposed establishment;
 - c. For an individual or for each person of a partnership or joint venture or agent of a corporation:
 - 1) Name and present address;
 - 2) The two immediately previous addresses, and dates of residence at each;
 - 3) Height, weight, color of hair and eyes, written proof of age, full set of fingerprints and two (2) photographs not more than thirty (30) days old, and at least 2" x 2";
 - 4) The business or occupation for the two (2) years immediately preceding the date of application;
 - 5) Whether a similar license had been revoked or suspended and, if so, the reason therefore and the location thereof;
 - 6) Whether convicted of any crime or ordinance violation other than traffic offenses within the past three (3) years and, if so, a listing of the same and the locations thereof;
 - d. If the applicant is a corporation, the names and addresses of each officer and director and of the stockholders of such corporation, together with the extent of the ownership of each, and a statement whether such officer, director or stockholder holds office or stock in any other corporation conducting a similar business in the State of Wisconsin. Such application shall be made by an agent registered as such who shall have been a resident of the City of Kenosha for at least ninety (90) days;
 - e. All phone numbers of the proposed establishment;
 - f. The names, addresses, state license number and two (2) photographs not more than thirty (30) days old, phone numbers of all persons employed as massage therapist or bodywork therapist by the applicant at the proposed establishment at the time of application;
 - g. The names, addresses, state license number and two (2) photographs not more than thirty (30) days old, phone numbers of any massage therapist or bodywork therapist other than those employed by the applicant, who may by virtue of any arrangement with the Licensee who practices, administers or offers to practice or administer massage or bodywork at the Licensed premises.
 - h. A floor plan of the establishment which details with particularity the rooms in which massage or bodywork will be practiced, the reception area, the restrooms and any other areas accessible to clientele.
 - i. Certification of compliance of the proposed premises with the Building Code and Fire Code, or in the alternative, applicant shall file a bond assuring that any work required to be done to bring the premises into compliance therewith shall be accomplished prior to the opening of business. Compliance with such Codes shall be conditions precedent to the opening of business.
 - j. The application shall contain a statement signed by the applicant and each individual of a partnership or joint venture that all information contained therein is true and correct;

C. Registry of Massage Therapists and Body Workers.

No person or entity shall engage in the practice of massage therapy or bodywork or perform massage therapy or bodywork for gain, unless such person has previously been issued and holds a valid license of registration pursuant to Wisconsin State Statutes. A licensed massage therapist or bodywork therapist may perform massage or bodywork therapy at a massage establishment licensed pursuant to this ordinance, appropriately zoned for the business and possessing a valid Occupancy Permit from the City Department of City Inspections, or at the place of residence or business of a client receiving massage or bodywork therapy. Massage or bodywork therapy shall not be performed as a home occupation in a residentially zoned district.

D. Granting of Licenses.

1. **Recommendation.** The City Clerk shall send a copy of the application to the Police Department,

CODE OF GENERAL ORDINANCES, 2021 - KENOSHA, WISCONSIN

who shall report, in writing, to the City Clerk, as to the arrest and conviction record of the applicant. The City Attorney, or designee thereof, shall examine said record and make a recommendation based thereon as to whether or not the applicant should be licensed. A recommendation for denial shall consider only such portions of the record as are materially related to the licensed activity as referenced in paragraph D.3. herein. Such reports shall be delivered to the City Clerk, who, in turn, shall deliver them, with the application, to the Committee on Licenses/Permits. Such Committee shall recommend to the Common Council either granting or denial of the application.

2. Licenses may be granted by the Common Council after a hearing at which the applicant may be heard at applicant's option.

3. The Common Council shall grant a license unless it is shown, for a massage establishment license, that the operation as proposed by the applicant does not comply with all applicable State Laws and City Ordinances, and that the applicant or any partner or any officer, director or stockholder of a corporate applicant has been convicted in a court of competent jurisdiction of an offense under Wis. Stat. ch. 944, or involving substances included in Wis. Stat. ch. 961, sub. II, or of an offense against the person or property of another within the past three (3) years; has been convicted of a violation of this ordinance or has been convicted of any other Federal, State, County or Municipal offense which are substantially similar or in conformity to those listed herein; that the information required on the application is incomplete or that any applicant has knowingly or with the intent to deceive make any false, misleading or fraudulent statement of fact in the application or any other document required by the City in conjunction therewith; or that the applicant has not resided in the City for at least ninety (90) days prior to date of application.

4. In the event of denial, the applicant shall receive written notification thereof setting forth the reasons for the denial within ten (10) days after such denial.

5. All licenses and permits granted by the Council shall expire on the thirty-first (31st) day of December following their issuance. Reapplication therefore shall be not less than sixty (60) days prior to such expiration date and shall be the sole responsibility of the applicant.

6. No license shall be transferred between locations or persons and no massage establishment license shall be sold or be subject to transfer of corporate assets or change of corporate officers or directors.

E. Regulations of Operations and Licenses.

1. Each establishment shall at all times maintain and comply with the following regulations:

a. Operational Regulations:

- 1) The establishment shall comply with all City Codes;
- 2) Only one (1) non-flashing business sign clearly identifying the establishment as a massage establishment shall be posted at the main entrance.
- 3) No establishment shall be open for business between the hours of 10:00 p.m. and 8:00 a.m.;
- 4) Only massage therapists or bodywork therapists licensed pursuant to Wisconsin State Statutes shall be employed as massage therapists or bodywork therapists by the establishment;
- 5) No person under the age of eighteen (18) years shall be permitted on the premises unless accompanied by his or her parent, guardian, or spouse or upon written authorization executed by the underage person's parent, guardian, or spouse;
- 6) No intoxicating beverages or substance included in Wis. Stat. ch. 961, sub. II, shall be permitted in the licensed establishment. Food shall be permitted only when there is no charge therefor and when a food preparation area, including sink with hot and cold running water, is a part of the establishment;
- 7) The establishment shall provide a waiting area for patrons separate from any area wherein

CODE OF GENERAL ORDINANCES, 2021 - KENOSHA, WISCONSIN

massages or bodywork are given. There shall be direct access to this area from the main entrance or from the hallway connected only to the main entrance;

8) A licensed massage therapist or bodywork therapists shall be present on the premises at all times during hours of operation, shall administer all massages or bodywork at the establishment and shall be responsible for the operation of the establishment;

9) The establishment shall permit inspections of the premises at any time during business hours by Director of City Inspections, Fire Inspectors, Health Inspectors, or personnel of any law enforcement agency for purpose of ascertaining compliance with this Section and conducting routine inspections. Any such inspection shall include areas let, subleased or subject to any other business management;

10) The establishment shall keep current records of the names, addresses and proof of State Licensure of its massage therapists or bodywork therapists, as well as the names and addresses of its agents, managers and employees and the date of employment and termination of each. Such records shall be open to inspection by any of the personnel listed in Subparagraph 9 above;

11) The establishment shall keep current records of the names, addresses and proof of State Licensure of any massage therapist or bodywork therapists, other than those employed by the Licensee, who may by virtue of any arrangement with the Licensee, practices, administers or offers to practice or administer massage or bodywork at the establishment. Such records shall be open to inspection by any of the personnel listed in Subparagraph 9 above;

12) The establishment shall report any change of fact required on the application form and all personnel changes to the City Clerk within ten (10) days after such change;

13) The establishment shall have and maintain in full force and effect during the license term a policy of malpractice insurance written by an insurance company licensed to do business in the State of Wisconsin, and verified by a certificate of insurance, in an amount of no less than One Million Dollars (\$1,000,000.00) in coverage per person;

14) Rooms in which massage or bodywork is to be practiced or administered shall have at least seventy (70) square feet of clear floor area and shall maintain a light level of no less than 40 foot candles as measured at three (3) feet above the floor. Lighting in colors other than white shall be prohibited. Such rooms shall not be locked during business hours or during massage or bodywork therapy sessions;

15) Massage or bodywork tables shall have a surface which is impervious to liquids and shall be furnished with linen, either disposable or washable, which are changed for each client;

16) Massage establishments shall prominently display on the premises their licenses during all hours of operation;

17) Massage establishments shall at all times be equipped with an adequate supply of clean sanitary towels, covering and linens. Clean towels, covering and linens shall be stored in cabinets or other appropriate facilities. Towels and linens shall not be used on more than one patron, unless they have first been laundered and disinfected. Soiled linens and paper towels shall be deposited in approved receptacles.

b. Prohibitions:

1) It shall be unlawful for any person, in a massage establishment, to engage in sexual contact as defined by Wisconsin Statutes § 939.22 (34) or sexual intercourse as defined by Wisconsin Statutes § 939.22 (36).

2) It shall be unlawful for any person, in a massage establishment, to expose his or her intimate parts, or any portion thereof, to any other person. It shall also be unlawful to expose the intimate parts, or any portion thereof, of any other person if done for the purpose of sexual humiliation, degradation, arousal, or gratification.

3) It shall be unlawful for any person, while in the presence of any other person in a massage establishment, to fail to conceal with a fully opaque covering, the intimate parts of his or her body if done for the purpose of sexual humiliation, degradation, arousal, or gratification.

4) It shall be unlawful for any person owning or operating a massage establishment, knowingly to cause, allow or permit in or about such massage establishment, any agent, employee, or any other person

CODE OF GENERAL ORDINANCES, 2021 - KENOSHA, WISCONSIN

under her/his control or supervision to perform such acts prohibited in Subparagraphs a. or b. of this section.

5) It shall be unlawful for any person in a massage establishment, for a consideration, to offer to perform or to make available, permit or in any way participate in the performance of any act prohibited by Subparagraphs a. or b. hereof.

F. Revocation, NonRenewal and Suspension of License. The Common Council, for just cause, may suspend, revoke, or not renew the license herein provided, upon serving upon Licensee written notice of the charges forming a basis for the proposed penalty, in the same manner as that for the service of a Summons in a civil action. Said notice shall provide for a hearing upon a written request therefor being filed with the City Clerk within ten (10) days of service. Absent a timely request for a hearing, the City Clerk shall administratively impose the penalty set forth in said notice.

1. Criteria For License Revocation, NonRenewal or Suspension. The license granted herein may not be renewed, may be revoked or may be suspended for up to six (6) months by the Common Council.

a. If the applicant has made or recorded any statement required by this section knowing it to be false or fraudulent or intentionally deceptive;

b. For the violation of any provision of this section, except for establishment license matters involving violations of City Codes, in which case the license shall be revoked after the second conviction thereof in any license year;

c. If an establishment license, after one (1) conviction of any establishment personnel of an offense under Wis. Stat. ch. 944, or of an offense against the person or property of a patron or of an offense involving substances in Wis. Stat. ch. 961, sub. II, where there is shown the participation or knowledge of any other establishment personnel or of any individual within the business structure of the applicant.

2. Disciplinary, NonRenewal, Suspension and Revocation Hearings. Disciplinary hearings, including nonrenewal, suspension and revocation hearings, shall be held before the Committee on Licenses/Permits, which shall submit a report to the Common Council, including Findings of Fact, Conclusions of Law and a recommendation as to what action, if any, the Common Council should take with respect to the License. The Committee on Licenses/Permits shall provide the Complainant and the Licensee with a copy of the report. Either the Complainant or Licensee may make an objection, orally or in writing, to the report and shall have the opportunity to present arguments supporting the objection to the Common Council. The Common Council shall determine whether the arguments shall be presented orally or in writing, or both. If the Common Council, after considering the Committee on Licenses/ Permits' report and any arguments presented by the Complainant and Licensee, finds the complaint to be true, or if there is no objection to a report recommending a suspension, revocation or nonrenewal, the Licensee shall be suspended, revoked or not renewed as provided by the Common Council. If the Common Council finds the complaint untrue, the proceedings shall be dismissed without cost to the accused. The City Clerk shall give notice of each suspension, revocation or nonrenewal to the party whose License is affected.

The judgment of conviction of any Licensee, or employee or agent thereof, in any Municipal, State or Federal Court, irrespective of whether obtained following trial, plea agreement, or bond forfeiture, shall be prima facie proof of said violation for purposes of this Ordinance. However, in the instance of any judgment of conviction entered pursuant to a no contest plea, or considered in law to be rendered pursuant to a no contest plea, said judgment of conviction as a prima facie case may be rebutted. Further mitigating circumstances may be introduced with respect to any judgment of conviction.

3. Commencement Of Penalties. Penalties shall commence the day after they have been imposed by the Common Council. Days of suspension shall run consecutively.

4. Reports By Police Chief. The Police Chief shall file reports with the City Attorney advising said City

CODE OF GENERAL ORDINANCES, 2021 - KENOSHA, WISCONSIN

Attorney of conduct by a Licensee, or employees thereof, which may constitute a basis for disciplinary action. The City Attorney, at License renewal time, or at any earlier time deemed appropriate, shall bring such matters to the attention of the Committee and make a recommendation on disciplinary action.

G. Exceptions. This section shall not apply to the businesses or professional establishments:

1. Offices, clinics, or establishments of physicians, surgeons, chiropractors, osteopaths, nurses, or physical therapists, licensed or registered to practice their respective professions under the laws of the State of Wisconsin, existing for the provision of such occupational services.

2. Barber shops and beauty parlors, which employ barbers and beauticians licensed under the laws of the State of Wisconsin, provided that such massage or bodywork as is practiced is limited to the head and scalp or where massage or bodywork is an ancillary service offered which accounts for less than 25% percent of the business's gross receipts.

H. Operation Without a License a Public Nuisance. The operation of a massage establishment without a license or the activity of an individual as a massage therapist or bodywork therapist without a license is deemed a public nuisance and may be enjoined by the City.

I. Penalty. Any person violating any provision of this section shall be subject to a forfeiture of not less than one hundred dollars (\$100) nor more than five hundred dollars (\$500). Each day of violation of operating without required licenses or permits and each violation of any provision hereof shall constitute a separate offense.

J. Severability. The provisions of any part of this ordinance are severable. If any provision or subsection hereof or the application thereof to any person or circumstances, is held invalid, the other provisions, subsections and applications of such ordinance to other persons or circumstances shall not be affected thereby. It is declared to be the intent of this ordinance that the same would have been adopted had such invalid provisions, if any, not been included herein.

K. Effective Date. This ordinance shall be effective upon publication except that establishments in full operation on such date shall comply with its provisions not later than sixty (60) days unless the Committee on Licenses/Permits, upon good cause shown, extends the sixty (60) days upon written request by an effected establishment.

13.13 REFUGE CENTERS

A. Purpose. The purpose of this ordinance is to insure that homeless persons in the City of Kenosha are able to obtain supportive services in safe and structured locations.

B. Definitions.

1. **Lodging:** Accommodations at which persons are allowed to sleep on mattresses, cots, sleeping bags, or other furnishings primarily designed for the sleeping of persons.

2. **Refuge Center:** A facility that provides accommodation principally for homeless persons, where the accommodation may include the provision of food, clothing, employment, or other support services, but shall exclude lodging.

3. **Staff:** Persons, whether paid or unpaid, who regularly and directly assist in the operation of the Refuge

CODE OF GENERAL ORDINANCES, 2021 - KENOSHA, WISCONSIN

Center. The term excludes volunteers who directly assist in the operation of the Refuge Center on an interim basis, but no more than any part of two days in any four-month period.

C. License Required.

1. Unless exempted from the licensing requirement pursuant to paragraph B 2., herein, no person whether personally, by agents or employees, singly, or with another business or enterprise may operate a Refuge Center within the City of Kenosha, and no person whether personally, by agents or employees, singly, or with another business or enterprise may allow the operation of a Refuge Center, without a license therefore from the Common Council in accordance with the provisions of this Ordinance.

2. The following are exempt from the regulation of this Section 13.13: A facility otherwise within the definition of "Refuge Center" that satisfies all of the following conditions:

a. is operated as a Shelter Facility, as that term is defined in the the Zoning Ordinance for the City of Kenosha;

b. is subject to a conditional use permit as a Shelter Facility and is operating under the terms of that conditional use permit.

3. Separate Licenses. A licensee hereunder who operates more than one (1) "Refuge Center" within the City shall be required to have in effect a separate license for each "Refuge Center".

4. Other Licenses And Permits. A license issued hereunder shall not exempt the holder thereof from obtaining such other licenses and permits as may be relevant and otherwise required by the City or by any other governmental agency.

D. Transfer/Assignment.

Licenses are not transferable or assignable from either person-to-person or from place-to-place.

E. License Term.

Licenses are for up to one year, expiring on the April 30th ensuing the grant of the license by the Common Council.

F. License Application.

1. Name, address, telephone number and e-mail address of Refuge Center license applicant, including all partners, if the applicant is a partnership.

2. Name, address, telephone number and e-mail address of Refuge Center manager, if different from the license applicant.

3. Current list of Board of Directors and Officers, if a corporation; current list of members if a limited liability company.

4. Organizational Chart listing supervisory personnel by name.

5. Complete list of the services and programs provided at the Refuge Center, whether delivered by agency

CODE OF GENERAL ORDINANCES, 2021 - KENOSHA, WISCONSIN

personnel or by outside organizations.

6. Floor plan identifying size and location of all Refuge Center areas.

7. Hours of operation including any periodic or seasonal schedule modifications.

8. Code of Conduct Plan which addresses the expectations and accountability of the clientele, including while on the Refuge Center premises and while off-site.

G. Annual Inspection.

Compliance monitoring by City departments shall occur annually, before action by the Common Council on the license application for each year.

H. Amendment/Correction.

Applicants and Licensees shall have the duty to amend and correct their application within ten (10) days of such time as any information stated therein is known by Applicant/Licensee to be untrue, incorrect or incomplete. No material change in scope of operation or site of operation shall be effective without the advance approval thereof by the Common Council.

I. Recommendation.

Upon receipt of an application for a license under this Section, the City Clerk shall send copies thereof to the Department of City Development, Department of City Inspections, Fire Department, Health Department, and Police Department. The Department of City Development, Department of City Inspections, Fire Department, and Health Department, either jointly or severally, within ten (10) days of receiving such copies, shall make a report, in writing, as to whether the premises meet the requirements hereof, along with any other pertinent information. The Police Department shall report in writing, to the City Attorney, as to any police record of applicant which may reflect upon their good moral character or business responsibility. The City Attorney shall examine said record and make a recommendation based thereon as to whether or not the license should be granted. Such reports shall be delivered to the City Clerk or clerk for the Licensing/Permit Committee who, in turn, shall deliver them with the application, to the Licensing/Permit Committee. Such Committee shall recommend to the Common Council either the granting or denial of the application or such other action as may be appropriate.

J. Conditions of Operation.

1. All supervision, whether paid or unpaid, must be trained in the requirements of this ordinance and in the policies of the Refuge Center.

2. During all operating hours, trained supervisory staff must be on premises and actively providing supervision to other staff, volunteers, and clientele.

a. Staffing provided must be adequate to serve the program needs of the clientele. Adequate staffing shall be determined based upon the professionally accepted standards to address the mental, physical and social needs of the clientele.

b. All staff must be at least 18 years old. Volunteers who assist in the operation of the Refuge Center on an interim basis, but no more than any part of two days in any four-month period may be under 18 years of age.

CODE OF GENERAL ORDINANCES, 2021 - KENOSHA, WISCONSIN

c. At least one member of staff holding current certification from the American Heart Association or the American Red Cross in first aid must be on premises at all times that the Refuge Center is open for business. A copy of the certification card for each staff member shall be on file at the licensed Refuge Center and subject to inspection.

d. All staff must be trained in fire/emergency procedures including the proper use of fire extinguishers.

e. All staff must have orientation training for the special needs of individuals who are homeless, experience mental health issues, chemical abuse issues, or intimate partner/domestic violence issues.

3. The Refuge Center must operate in compliance with the Fire Prevention Code, the Property Maintenance Code, and all other City ordinances.

4. Provide restrooms in compliance with the federal Americans with Disabilities Act with an adequate number of fixtures for the number of occupants.

5. Allow clientele access for restroom privileges during all hours of operation.

6. If the clientele of the Refuge Center will include minors, all staff shall have a criminal background check conducted annually by the Refuge Center licensee which shall be subject to inspection.

7. If the clientele of the Refuge Center will include minors, the Refuge Center licensee must have procedures in place that assure that no individual minor will be alone in any enclosed space with any one adult who is not the minor's parent, guardian, spouse, or sibling.

8. Adequate external lighting shall be provided for security purposes. The lighting shall be stationary, directed away from adjacent properties and public right-of-way, and of an intensity compatible with the neighborhood. The light shall be positioned and maintained in a manner that does not unreasonably provide annoyance to residents of neighboring properties.

K. Enforcement.

The Director of the Department of City Development, Department of City Inspections, the Fire Chief, the Chief of Police, and the Director of Environmental Health for the County of Kenosha shall have the primary responsibility to enforce this Ordinance within their jurisdiction. In the event that any of the aforementioned directors or chiefs receive a complaint outside of their jurisdiction, they shall refer it to the Department having proper jurisdiction. After normal City Municipal Building working hours, all complaints shall be made to the Police Department, who, where the complaint is outside of its jurisdiction, shall take the complaint and refer it to the Department having proper jurisdiction. This Ordinance shall be enforced by the following City Departments (Enforcing Departments) as follows:

1. By the Director of the Department of City Development, Department of City Inspections or designee thereof, with respect to the Building Code (Chapter IX of the Code of General Ordinances for the City of Kenosha) the Sign Code (Chapter XV), the Property Maintenance Code (Chapter XVI), the Zoning Ordinance, and other provisions of the Code of General Ordinances not otherwise enforced by other Enforcing Departments, along with the responsibility of investigating complaints to the effect that a person is engaged in an activity requiring a license hereunder without first having obtained said license.

2. By the Fire Chief, or designee thereof, with respect to the Fire Prevention Code (Chapter III).

CODE OF GENERAL ORDINANCES, 2021 - KENOSHA, WISCONSIN

3. By the Chief of Police or designee thereof, with respect to Good Order and Conduct Code (Chapter XI) and Noise Control Code (Chapter XXIII).

4. By the Health Director or designee thereof, with respect to the Health Code (Chapter IV) and Noise Control Code (Chapter XXIII).

L. Inspections.

Applicants and Licensees shall permit authorized representatives of any Department of the City or County having enforcement powers hereunder to inspect the premises proposed to be licensed or licensed, with or without advanced notice, as often as may be required to permit said Departments to perform their duties and assure compliance with this Ordinance, without first obtaining a special inspection warrant. Inspections shall be made during normal hours of business operation unless emergency circumstances require prompt action to protect the public health, safety, or welfare, or to preserve evidence of noncompliance with this Ordinance. The unreasonable failure to permit inspections shall be grounds for license denial, suspension, or revocation. Upon notice of application by the City Clerk to the Enforcing Departments, they shall inspect the premises/equipment of each license applicant and licensee seeking license renewal, where they have duties with respect thereto, as part of the application/license renewal process and prior to application review. The Fire Chief, or designee thereof, shall make periodic inspections of Licensee premises/equipment during the license period and report apparent violations of this Ordinance over which it does not have jurisdiction to any Enforcing Department having jurisdiction thereover. Enforcing Departments may also inspect the premises/equipment of any Licensee upon a complaint being made with respect thereto by any person.

M. Orders.

It shall be unlawful for any licensee to fail to obey any final order of any Enforcing Department which was issued under the authority hereof.

N. Appeals From Orders.

A Licensee, where the public health, safety or welfare is not in immediate jeopardy, may appeal to the Common Council any order issued by any Enforcing Department under authority of this Ordinance. Orders issued pursuant to ordinances subject to specific appeal procedure must be appealed through that specific appeal procedure. All other orders issued pursuant to ordinances that are not subject to a specific appeal procedure, may be appealed to the Common Council by filing a written Notice of Appeal with the Enforcing Department that issued the order within ten (10) days of receipt of said order, or within the compliance period, whichever is shorter. The Common Council may direct that an appeal to it be heard by a Committee thereof.

O. Licensees/Responsibility.

Licensee shall, with respect to the conduct of their operation, have a duty to supervise their employees and clientele, and for purposes of license discipline proceedings, shall be responsible for the acts thereof.

P. Revocation and Suspension Of Licenses.

The Common Council may, for just cause, suspend or revoke any license herein provided, upon serving such party written notice of the charges forming a basis for the proposed penalty, in the same manner as that for the service of a Summons in a civil action. Just cause shall include, but not be limited to:

1. Failing to maintain a status of good moral character and business responsibility.
2. Obtaining the license through fraud or misrepresentation.

CODE OF GENERAL ORDINANCES, 2021 - KENOSHA, WISCONSIN

3. Operating contrary to the terms of this Ordinance.
4. Failing to commence doing business within ninety (90) days of being granted a license.

Q. Disciplinary Hearings.

Disciplinary hearings, including suspension and revocation hearings, may be held before the Common Council or before the Committee charged with license review responsibilities. The Licensing/Permit Committee, when it conducts a hearing, shall submit a report to the Common Council, including findings of fact, conclusions of law and a recommendation as to what action, if any, the Common Council should take with respect to the license. Said Committee shall provide the complainant and the licensee with a copy of the report. Either the complainant or Licensee may file an objection to the report and shall have the opportunity to present arguments supporting the objection to the Common Council. The Common Council shall determine whether the arguments shall be presented orally or in writing, or both. If the Common Council, after considering the Committee's report and any arguments presented by complainant or Licensee, finds the complaint to be true, or if there is no objection to a report recommending a suspension or revocation of the license, it shall be suspended, revoked, or not renewed as provided by law. If the Common Council finds the complaint untrue, the proceedings shall be dismissed without cost to the accused. The City Clerk shall give notice of each suspension or revocation to the party whose license is affected. The Common Council may also order corrective action to be taken within a specified time as a condition of license maintenance, at any time, following notice and an opportunity to be heard.

R. Penalty.

Any person who shall violate any of the terms and conditions of this Ordinance shall, upon conviction thereof, forfeit not more than Five Hundred (\$500) Dollars, plus the costs of prosecution, in addition to all applicable surcharges and assessments, and in default of the timely payment thereof be confined in the County Jail for a period not to exceed thirty (30) days.

13.14 COMMERCIAL QUADRICYCLE LICENSING

A. Definitions.

1. Applicant means the individual applying for a license under this section or any person who is an officer of a corporation that is applying for a license under this section.
2. Commercial quadricycle means a vehicle with fully operative pedals for propulsion entirely by human power that:
 - a. Has four wheels and is operated in a manner similar to a bicycle;
 - b. Is equipped with at least 12 seats for passengers;
 - c. Is designed to be occupied by a driver and by passengers providing pedal power to the drive train of the vehicle;
 - d. Is used for commercial purposes; and
 - e. Is operated by the vehicle owner or an employee of the owner.
3. Commercial quadricycle business means any enterprise that owns a commercial quadricycle or manages the operation of a commercial quadricycle.
4. Commercial quadricycle operator's license means an operator's license as described in section D below.

CODE OF GENERAL ORDINANCES, 2021 - KENOSHA, WISCONSIN

5. Public commercial quadricycle operator means any person who operates a commercial quadricycle or commercial quadricycle which transport passengers for hire or compensation.

B. Licenses Required.

1. **Commercial Quadricycle Business License.** No person may engage in a commercial quadricycle business unless each commercial quadricycle used in the business is licensed. A commercial quadricycle business license shall expire on December 31 of each year.

2. **Operator's License.** No person may operate a commercial quadricycle for purposes upon a highway or public road unless the person is licensed as a public commercial quadricycle operator. The public commercial quadricycle operator's license shall expire on December 31 of each year.

C. Commercial Quadricycle Business Application Process.

1. **Application.** A person wishing to operate a commercial quadricycle business shall apply to the City Clerk for a business license pursuant to this ordinance using forms furnished by the City Clerk and pay the Clerk a \$25.00 license fee for each commercial quadricycle managed by the person. The Clerk shall forward the application to the police department for review. If the police department approves the application, it shall forward its recommendation to the City Clerk. The police department shall deny the application if any of the following applies:

a. The circumstances of a pending criminal charge against the applicant substantially relate to the licensed activity.

b. The applicant has been convicted of any felony, misdemeanor or other offense, the circumstances of which substantially relate to the particular job or licensed activity.

c. The applicant made a false statement on the application.

d. The applicant is under 18 years old.

2. **Licensed Route Approval.** Should the investigation by the police department indicate that the applicant is eligible for a commercial quadricycle business license, the City Clerk shall forward the application to the Committee on Public Works for the Committee recommendation to approve, deny, or amend the proposed route and license. The Common Council shall affirm, reverse, or modify the Committee's recommendation. Operation of a commercial quadricycle business is permitted only on an approved route.

3. **Appeal.** If the police department denies an application for a commercial quadricycle business license, the applicant may appeal within 15 days after the City Clerk mails a notice of denial to the applicant. If the applicant files a timely appeal with the Clerk, the Clerk shall schedule an appeal hearing before the Committee on Public Works.

4. **Hearing Before Committee.** The Committee on Public Works may recommend to the Common Council either the approval of any application placed on its agenda only if the applicant is qualified under this section and may place conditions upon approval, or may recommend the denial of the application. The Common Council shall affirm, reverse or modify the Committee's decision.

5. **Issuance.** The Clerk shall issue the commercial quadricycle business license if the applicant has been approved by the Common Council and has satisfied all other provisions of this section.

6. **Insurance.** Maintain liability insurance coverage for the commercial quadricycle containing the limits of not less than \$1,000,000.00 per occurrence combined single limit bodily injury and property damage,

CODE OF GENERAL ORDINANCES, 2021 - KENOSHA, WISCONSIN

issued by a company authorized to do business in the state. A certificate of insurance coverage specific to each commercial quadricycle shall be filed with the City Clerk.

7. Documents Available For Review. At all times of operation of a commercial quadricycle, the following documentation must be available upon a commercial quadricycle for inspection and review upon request by the police department:

- a. The commercial quadricycle license.
- b. The operator's license of the quadricycle operator.
- c. Proof of liability insurance.
- d. The name or trade name of the commercial quadricycle business and the 24-hour contact phone number of the operator.

D. Commercial Quadricycle Operator's License Application Process.

1. Application. A person wishing to obtain a commercial quadricycle operator's license shall apply to the City Clerk using forms furnished by the City Clerk and pay to the Clerk a \$25.00 license fee and submit an acceptable passport-sized photo. The Clerk shall forward the application to the police department for review. If the police department approves the application, it shall forward its recommendation to the Clerk. The police department shall deny the application if any of the following applies:

- a. The circumstances of a pending criminal charge against the applicant substantially relate to the licensed activity.
- b. The applicant has been convicted of any felony, misdemeanor or other offense the circumstances of which substantially relate to the particular job or licensed activity.
- c. The applicant made a false statement on the application.
- d. The applicant is under 18 years old.
- e. The applicant does not hold a valid Wisconsin driver's license or a valid driver's license issued by any other State in the United States.

2. Appeal. If the police department denies an application for a commercial quadricycle operator's license, the applicant may appeal within 15 days after the City Clerk mails a notice of denial to the applicant. If the applicant files a timely appeal with the Clerk, the Clerk shall schedule an appeal hearing before the Committee of Public Works. The Committee on Public Works may recommend to the Common Council the approval of the application only if the applicant is qualified under this section and may place conditions upon approval, or may recommend the denial of the application. The Common Council shall affirm, reverse or modify the Committee's recommendation.

3. Issuance. The Clerk shall issue a commercial quadricycle operator's license if the applicant has been approved by the police department or the Common Council and has satisfied all other provisions of this section.

E. Commercial Quadricycle Regulations. The owner and operator of a commercial quadricycle are both responsible for ensuring compliance with this subsection.

1. Licensees must adhere to the routes specified in their submitted application. New routes must be applied for and approved by the Common Council before a licensee may use the new routes. No licensee shall operate a commercial quadricycle on a street closed off to public traffic regardless of whether the street

CODE OF GENERAL ORDINANCES, 2021 - KENOSHA, WISCONSIN

is included in an approved route. Any deviation from an approved route without approval shall be a violation of this section.

2. Commercial quadricycle operation is permitted between the hours of 10:00 am and 10:30 pm. Commercial quadricycle operation does not include the use of a commercial quadricycle for maintenance, inspection, or without passengers. Operation of a commercial quadricycle beyond permitted hours is prohibited.

3. It is unlawful for any person to operate or to permit another to operate a commercial quadricycle at other times or in other locations than those approved by the Common Council or the chief of police or his or her designee.

4. No public commercial quadricycle operator shall drive, or be permitted by a public commercial quadricycle operator to drive, a commercial quadricycle without a valid Wisconsin driver's license or a valid driver's license issued by any other state in the United States.

5. Passengers on a commercial quadricycle may possess on or carry onto the commercial quadricycle no more than 36 ounces of fermented malt beverages as defined in Wis. Stat. § 125.02(6). No other alcohol beverages, as defined in ch. 125, Wis. Stats., may be possessed on, carried upon, or consumed upon a commercial quadricycle.

6. No glass containers may be carried on a commercial quadricycle.

7. Restrictions on possession, transportation and consumption of alcohol beverages in the operation of commercial quadricycles upon city highways and public places shall apply to operation of commercial quadricycles when used for non-revenue producing events or transportation in addition to regular commercial activities.

8. No driver of a commercial quadricycle may consume alcohol while the commercial quadricycle is occupied by passengers:

9. No person may drive a commercial quadricycle with an alcohol concentration of more than 0.02.

10. No person may drive a commercial quadricycle on which any alcohol beverages are carried or consumed other than fermented malt beverages under this section.

11. No person may drive a commercial quadricycle on which alcohol beverages are sold and may not transport alcohol beverages on a commercial quadricycle for the purposes of sale or delivery upon sale.

12. Passengers shall be advised by the operator, driver or other person responsible for the operation of the commercial quadricycle that no alcohol beverages shall be possessed on, carried upon, or consumed on a commercial quadricycle in violation of city ordinance or state statute, and shall conspicuously post a notice of these restrictions upon the commercial quadricycle in a form and manner approved by the city.

13. The operator of the commercial quadricycle shall hold a valid commercial quadricycle operator's license issued pursuant to this ordinance.

14. The operator of the commercial quadricycle shall operate the vehicle at all times in compliance with applicable local and state traffic and parking laws.

15. The operator of a commercial quadricycle shall remain with the quadricycle at all times fermented malt beverages are on board the quadricycle.

16. Failure of a person to comply with the regulations of this section or to operate in accordance with

CODE OF GENERAL ORDINANCES, 2021 - KENOSHA, WISCONSIN

the approved plan of operation shall constitute grounds for nonrenewal suspension or revocation.

17. The Common Council may adopt and from time to time amend the regulations relating to commercial quadricycles and their operations, including, but not limited to, hours of operations, routes, vehicle markings and safety equipment.

F. Revocation, NonRenewal, and Suspension of License. The Common Council, for just cause may suspend, revoke, or not renew the license herein provided, upon serving upon Licensee written notice of the charges forming a basis for the proposed penalty, in the same manner as that for the service of a Summons in a civil action.

1. Criteria For License Revocation, NonRenewal or Suspension. The license granted herein may not be renewed, may be revoked or may be suspended for up to six (6) months by the Common Council.

a. If the applicant has made or recorded any statement required by this section knowing it to be false or fraudulent or intentionally deceptive;

b. For the violation of any provision of this ordinance.

2. Disciplinary, NonRenewal, Suspension and Revocation Hearings. Disciplinary hearings, including nonrenewal, suspension and revocation hearings, shall be held before the Committee on Public Works, which shall submit a report to the Common Council, including Findings of Fact, Conclusions of Law and a recommendation as to what action, if any, the Common Council should take with respect to the License. The Committee on Public Works shall provide the Complainant and the Licensee with a copy of the report. Either the Complainant or Licensee may make an objection, orally or in writing, to the report and shall have the opportunity to present arguments supporting the objection to the Common Council. The Common Council shall determine whether the arguments shall be presented orally or in writing, or both. If the Common Council, after considering the Committee on Licenses/ Permits' report and any arguments presented by the Complainant and Licensee, finds the complaint to be true, or if there is no objection to a report recommending a suspension, revocation or nonrenewal, the Licensee shall be suspended, revoked or not renewed as provided by the Common Council. If the Common Council finds the complaint untrue, the proceedings shall be dismissed without cost to the accused. The City Clerk shall give notice of each suspension, revocation or nonrenewal to the party whose License is affected.

The judgment of conviction of any Licensee, or employee or agent thereof, in any Municipal, State or Federal Court, irrespective of whether obtained following trial, plea agreement, or bond forfeiture, shall be prima facie proof of said violation for purposes of this Ordinance. However, in the instance of any judgment of conviction entered pursuant to a no contest plea, or considered in law to be rendered pursuant to a no contest plea, said judgment of conviction as a prima facie case may be rebutted. Further mitigating circumstances may be introduced with respect to any judgment of conviction.

3. Commencement Of Penalties. Penalties shall commence the day after they have been imposed by the Common Council. Days of suspension shall run consecutively.

4. Reports By Police Chief. The Police Chief shall file reports with the City Attorney advising said City Attorney of conduct by a Licensee, or employees thereof, which may constitute a basis for disciplinary action. The City Attorney, at License renewal time, or at any earlier time deemed appropriate, shall bring such matters to the attention of the Committee and made a recommendation on disciplinary action.

G. Penalty. Any person violating any provision of this section shall be subject to a forfeiture of not less than one hundred dollars (\$100) nor more than five hundred dollars (\$500). Each day of violation of operating without required licenses or permits and each violation of any provision hereof shall constitute a separate offense.

CODE OF GENERAL ORDINANCES, 2021 - KENOSHA, WISCONSIN

H. Severability. The provisions of any part of this ordinance are severable. If any provision or subsection hereof or the application thereof to any person or circumstances, is held invalid, the other provisions, subsections and applications of such ordinance to other persons or circumstances shall not be affected thereby. It is declared to be the intent of this ordinance that the same would have been adopted had such invalid provisions, if any, not been included herein.

13.15 FEES

Any person, firm or corporation who shall violate the provisions of this Chapter, shall upon conviction thereof, be punished by a fine of not more than Two Hundred (\$200.00) Dollars and costs of prosecution and in default of payment thereof shall be imprisoned in the County Jail not to exceed thirty (30) days.

CODE OF GENERAL ORDINANCES, 2021 - KENOSHA, WISCONSIN

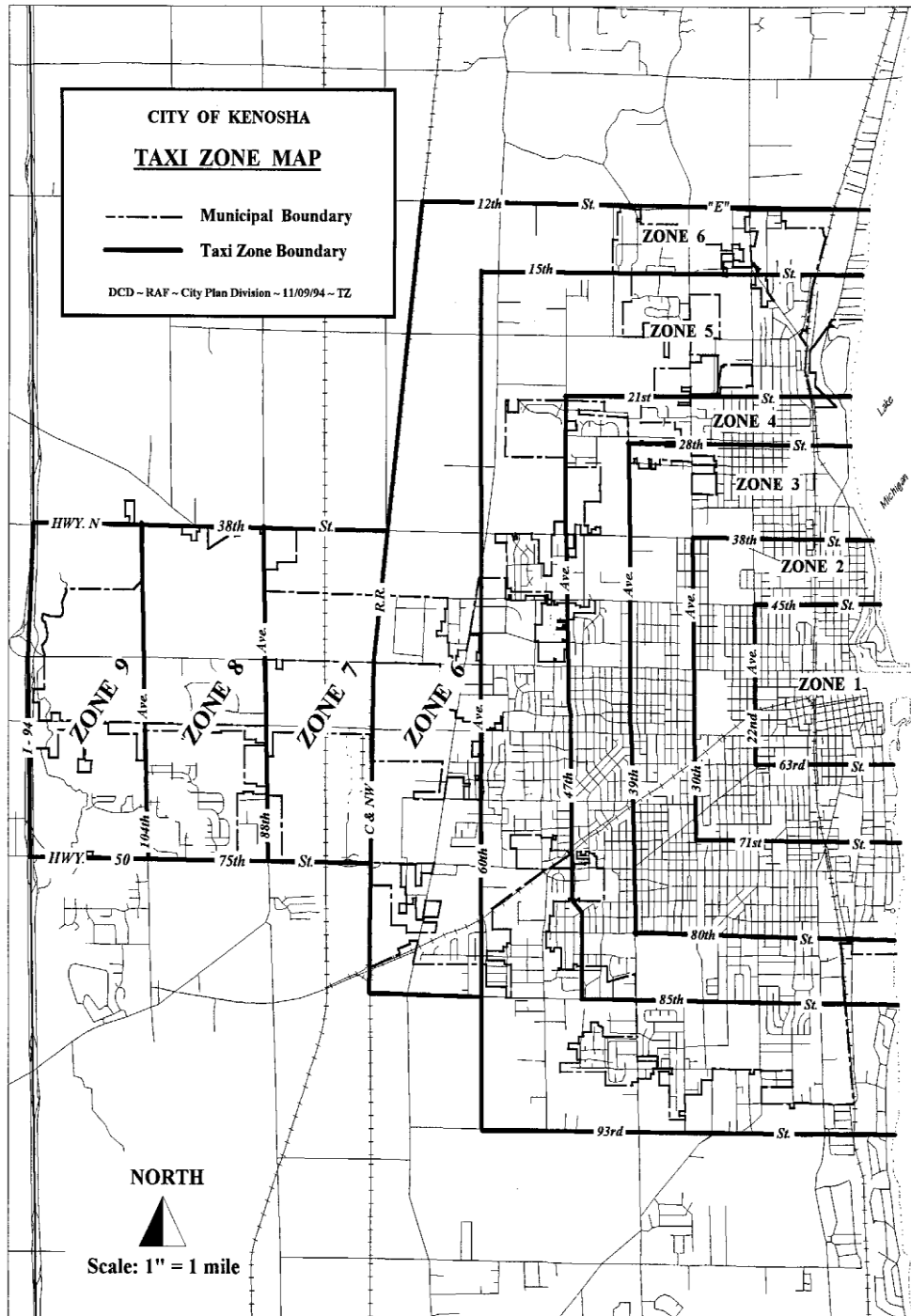

CODE OF GENERAL ORDINANCES, 2021 - KENOSHA, WISCONSIN

APPENDIX 13.07 D.1.

CITY OF KENOSHA TAXICAB SAFETY AND PERFORMANCE CHECKLIST

WALK AROUND INSPECTION	UNDER HOOD	
Operation of all exterior lights.	Check radiator for leaks/looseness.	Transmission/transaxle mounts.
All reflectors and lenses.	Check nonelectric cooling fan for play.	Driveline/U-joints/support bearings.
Mirror mounts and glass.	Pressure test cooling system.	Engine exhaust system.
Vehicle body/paint.	Coolant hoses/recovery system.	Inspect rear axle for oil leaks (if applicable).
Bumpers.	Record coolant protection level.	Rear suspension.
Hood/door/truck hatch hinges.	Pressure test radiator cap.	Rear brakes and hydraulic lines.
Windshield/windows.	Tension/Condition of all belts.	Parking brake cables/operation.
Roof.	Power steering fluid level/hoses.	Record rear brake lining thickness
INTERIOR	All accessory mounts/brackets.	Inspect rear brake drum/rotor condition.
Seats/seatbelts/shoulder harness.	Fuel throttle linkage/cables.	Fuel tank/supports/lines/cap.
Door locks/latches/releases.	Check engine for major oil leaks.	DRIVE TEST
Floorboard and covering.	Integrity of air intake system.	Operation of vehicle systems at normal operating temperature.
Interior lighting.	Wiring/connections to electrical devices.	Engine throttle response & performance
Instrument panel warning lights/gauges.	Battery area.	Observe exhaust for excessive smoke emissions.
Engine operation.	Check/record battery state of charge & load test.	Transmission/clutch operation.
Horn operation.	Ignition/distributor system.	Operation of all gauges & indicators.
Heater-A/C-Defroster controls.	Emissions related component-visual.	Steering wheel travel or bind.
Rear view mirror/sun visors.	Check all fluid levels.	Observe road handling.
Parking brake operation.	UNDER CAR/CHASSIS	Test brake operation at various road speeds.
Windshield, door and rear glass.	Steering gear/rack & pinion mounts.	Parking brake operation.
Switches & accessories operation.	Steering shaft and linkage.	Listen for any unusual noises.
Steering wheel free travel.	Check ball joints for wear.	
Clutch pedal free travel (if applicable)	Check struts/shocks for leaks.	
TIRES/WHEELS	Front wheel bearing adjustment.	
Irregular wear (alignment).	C.V. shafts and boots.	
Cuts and sidewall damage.	Front brakes and hydraulic lines.	
Inspect valve caps.	Front brake drum/rotor condition.	Wear limits, out of service criteria, and specifications are obtained by the vehicle or component manufacturer. Accepted Industry standards, practices and methods should be followed while performing the inspections.
Inspect thread depth at 3 location - 2/32"min.	Record front brake lining thickness.	
Record thread depth for each tire.	Record front brake rotor thickness.	
Check/record tire pressures. Include spare tire.	Brake vacuum/hydroboost operation.	
Wheel nut torque.	Front springs and mounts	
Missing or damaged axle studs.	Engine supports/cushions	
Bent/damaged wheels.	Starter and cables.	
Check for spare & jack/lug wrench.	Check for under car fluid leaks.	

CODE OF GENERAL ORDINANCES, 2021 - KENOSHA, WISCONSIN

APPENDIX 13.12 CITY OF KENOSHA TOW TRUCK SAFETY MAINTENANCE CERTIFICATION

WALK AROUND INSPECTION	UNDER HOOD	
Operation of all exterior lights.	Check radiator for leaks/looseness.	Transmission/transaxle mounts.
All reflectors and lenses.	Check nonelectric cooling fan for play.	Driveline/U-joints/support bearings.
Mirror mounts and glass.	Pressure test cooling system.	Engine exhaust system.
Vehicle body/paint.	Coolant hoses/recovery system.	Inspect rear axle for oil leaks (if applicable).
Bumpers.	Record coolant protection level.	Rear suspension.
Hood/door/truck hatch hinges.	Pressure test radiator cap.	Rear brakes and hydraulic lines.
Windshield/windows.	Tension/Condition of all belts.	Parking brake cables/operation.
Roof.	Power steering fluid level/hoses.	Record rear brake lining thickness.
INTERIOR	All accessory mounts/brackets.	Inspect rear brake drum/rotor condition.
Seats/seatbelts/shoulder harness.	Fuel throttle linkage/cables.	Fuel tank/supports/lines/cap.
Door locks/latches/releases.	Check engine for major oil leaks.	DRIVE TEST
Floorboard and covering.	Integrity of air intake system.	Operation of vehicle systems at normal operating temperature.
Interior lighting.	Wiring/connections to electrical devices.	Engine throttle response & performance
Instrument panel warning lights/gauges.	Battery area.	Observe exhaust for excessive smoke emissions.
Engine operation.	Check/record battery state of charge and I oad test.	Transmission/clutch operation.
Horn operation.	Ignition/distributor system.	Operation of all gauges & indicators.
Heater-A/C-Defroster controls.	Emissions related component-visual.	Steering wheel travel or bind.
Rear view mirror/sun visors.	Check all fluid levels.	Observe road handling.
Parking brake operation.	UNDER CHASSIS	Test brake operation at various road speeds.
Windshield, door and rear glass.	Steering gear/rack & pinion mounts.	Parking brake operation.
Switches & accessories operation.	Steering shaft and linkage.	Listen for any unusual noises.
Steering wheel free travel.	Check ball joints for wear.	HOIST OPERATION
Clutch pedal free travel (if applicable)	Check struts/shocks for leaks.	Check condition & operation of hoist.
TIRES/WHEELS	Front wheel bearing adjustment.	Wear limits, out of service criteria, and specifications are obtained by the vehicle or component manufacturer. Accepted Industry standards, practices and methods should be followed while performing the inspections
Irregular wear (alignment).	C.V. shafts and boots.	
Cuts and sidewall damage.	Front brakes and hydraulic lines.	
Inspect valve caps.	Front brake drum/rotor condition.	
Inspect thread depth at three locations - 2/32" min.	Record front brake lining thickness.	
Record thread depth for each tire.	Record front brake rotor thickness.	
Check/record tire pressures. Include spare tire.	Brake vacuum/hydroboost operation.	
Wheelnut torque.	Front springs and mounts	
Missing or damaged axle studs.	Engine supports/cushions.	
Bent/damaged wheels.	Starter and cables.	
	Check for fluid leaks.	

CODE OF GENERAL ORDINANCES, 2021 - KENOSHA, WISCONSIN

CHAPTER XIV ANIMALS, BIRDS AND FOWL

14.001 DEFINITIONS

For the purpose of this Chapter, the following definitions shall apply in the interpretation and enforcement of this Chapter.

A. Abandoned Cat. The term "abandoned cat" shall apply to any domesticated cat that an owner has forsaken entirely or neglected or refused to provide care and support.

B. Animal. The term "animal" shall apply to any living thing that is not human or a plant, and generally capable of voluntary motion or sensation.

C. Bitten. The term "bitten" shall mean seizure of any portion of a human being or another animal's anatomy by the teeth or jaws of an animal or contact of saliva from an animal with any break or abrasion of the skin of another animal or person.

D. Cat. The term "cat" shall apply to any feline animal, male or female, sexed or neutered.

E. Collecting Official. The term "collecting official" shall mean anyone designated pursuant to Wis. Stats. §174.065.D.

F. Community Cat. The term "community cat" shall mean a feral cat that does not have an Owner.

G. Community Cat Caretaker. The term "community cat caretaker" shall mean any Feral Cat Caretaker who is approved by a Sponsor to care for a Feral Cat.

H. Community Service Officer (CSO). The term "Community Service Officer (CSO)" shall mean any person employed or appointed by Kenosha or a municipality who is authorized to investigate violations of laws and regulations concerning animals, and to issue citations in accordance with Wisconsin law.

I. Department. The term Department shall mean any person employed with the Kenosha Police Department.

J. Dog. The term "dog" shall apply to any canine animal, male or female, sexed or neutered.

K. Domesticated Cat. The term "domesticated cat" shall apply to any cat that is socialized to humans and is appropriate as a companion for humans.

L. Ear Tipping. The term "ear tipping" shall mean a straight-line cutting of the tip of the left ear of a cat while the cat is anesthetized.

M. Feral Cat. The term "feral cat" shall apply to any cat that (i) is born in the wild or is the offspring of an owned or feral cat and is not socialized or (ii) is a formerly owned cat that has been abandoned and is no longer socialized.

N. Feral Cat Caretaker. The term "feral cat caretaker" shall mean any person other than an owner who provides food, water or shelter to, or otherwise cares for, a feral cat.

O. Humane Society. The term "Humane society" shall mean any organization that promulgates best practices for animal sheltering, provides assistance to shelter and sheltering programs, and provides veterinary services for animals in impoverished communities.

P. Micro-Chipping. The term "micro-chipping" shall mean, for the purpose of this Ordinance, to implant an EAID (electronic animal identification device) in an animal.

Q. Nuisance. The term "nuisance" shall mean, for the purpose of this Ordinance, conduct by stray or

CODE OF GENERAL ORDINANCES, 2021 - KENOSHA, WISCONSIN

feral cats that disturb the peace. Stray or feral cats may create a nuisance by (a) habitually or continually howling, crying or screaming, or (b) habitually and significantly destroying, defiling or soiling property against the wishes of the owner of the property, or (c) loitering against the permission of the property owner.

R. Own. The term "own", unless otherwise specified, shall be deemed to mean keep, harbor, or have control, charge or custody of an animal, or permit to be kept, harbored or fed upon or within premises owned, leased, rented or occupied by a person and does not require actual legal title or right to the animal.

S. Owner. The term "owner" shall mean any person having a right of property in an animal or who keeps or harbors an animal, or who has it in his or her care, or acts as its custodian, or who knowingly permits an animal to remain on any premises occupied by him or her. This term does not include a Community Cat Caretaker.

T. Person. The term "person" shall mean any natural person, partnership or corporation.

U. Scratched. The term "scratched" shall mean the scraping or clawing of any portion of another animal or a human being's anatomy by an animal.

V. Sponsor. The term "sponsor" shall mean any animal humane society that agrees to comply with the requirements of this Ordinance.

W. Stray Cat. The term "stray cat" shall mean a cat that is regularly off the property of the owner, is not under the physical control and restraint of the owner, and is not regularly provided with food by its owner.

X. Tether. The term "tether" shall mean something by which an animal is fastened so that it can range only within a set range.

Y. TNR. The term "TNR" shall mean Trap, Neuter and Return.

Z. TNR Program. The term "TNR Program" shall mean a program pursuant to which feral and stray cats are trapped, neutered or spayed, micro-chipped, vaccinated against rabies, and returned to the location where they congregate, in accordance with this Ordinance.

aa. Veterinarian. The term "veterinarian" shall mean a natural person duly licensed to practice veterinary medicine in the State of Wisconsin and possessing a doctor's degree in veterinary medicine.

14.01 DOGS AND CATS

A.1. Dog License Tax. Every person who owns, harbors or keeps a dog within the limits of the City of Kenosha, which is more than five (5) months of age on January 1 of any year or which becomes five (5) months of age within the license year, shall annually, or on or before the date the dog becomes five (5) months of age, pay to the City Clerk or collecting official his/her dog license tax and obtain a license.

2. Collar Tag. Following issuance of a license, the City Clerk or collecting official shall deliver to the owner a tag bearing the same serial number as designated on the license, the name of the County in which license was issued, and the license year. The owner shall securely attach the tag to a collar which shall be kept on the licensed dog at all times. This requirement to wear a tag and collar does not apply to a dog during competition or training, a dog securely confined indoors, or to a dog while hunting.

3. Fee. For the license term commencing January 1, 2003, the dog license tax shall be Four (\$4.00) Dollars for a neutered male dog or spayed female dog, upon presentation of evidence that the dog is neutered or spayed, and Ten (\$10.00) Dollars for an unneutered male dog or unspayed female dog, or one-half (1/2) of these amounts if the dog became five (5) months of age after July 1 of the license year. For the license term commencing January 1, 2013, the dog license tax shall be Ten (\$10.00) Dollars for a neutered male dog or spayed female dog, upon presentation of evidence that the dog is neutered or spayed, and Twenty-Five (\$25.00) Dollars for an unneutered male dog or unspayed female dog. Effective July 1, 2013, the dog license tax shall be Fifteen Dollars (\$15.00) for a neutered male or spayed female dog, upon presentation of evidence that the dog is neutered or spayed, and Thirty-five Dollars (\$35.00) for an unneutered male dog or unspayed

CODE OF GENERAL ORDINANCES, 2021 - KENOSHA, WISCONSIN

female dog, or one-half (½) of these amounts if the dog became five (5) months of age after July 1 of the license year.

4. Late Fee. A late fee of Five (\$5.00) Dollars shall be paid to the City Clerk or collecting official by every owner of a dog five (5) months of age or over, if the owner failed to obtain a license prior to April 1st of each year, or within thirty (30) days of acquiring ownership of a licensable dog or if the owner failed to obtain a license on or before the dog reached licensable age.

B.1. Cat License Required for Cats. Every person who owns, harbors or keeps a cat within the limits of the City of Kenosha, which is more than five (5) months of age on January 1 of any year or which becomes five (5) months of age within the license year, shall annually, on or before the date the cat becomes five (5) months of age, pay to the City Clerk or collecting official his/her cat license fee and obtain a license.

2. Collar Tag or Computer Microchip. Following issuance of a license, the City Clerk shall deliver to the owner a tag bearing the same serial number as designated on the license, the name of the City of Kenosha, and the license expiration date. The owner shall securely attach the tag to a collar which shall be kept on the licensed cat at all times. This requirement to wear a tag and collar does not apply to a cat during competition or training, or a cat securely confined indoors.

A collar tag shall not be required to be worn by any cat which is licensed during the year that the license is valid, if the cat has a computer microchip encoded with identifying information which has been subcutaneously inserted within the cat. Said chip must be registered with a national registry and be easily read with magnetic scanners. Said identifying information shall include the name and current address of the owner, as that term is defined herein, who licensed the cat.

3. License Fee. For the license term commencing January 1, 2003, the cat license fee shall be Four (\$4.00) Dollars per year for each year of the license term for a neutered male cat or spayed female cat, upon presentation of evidence that the cat is neutered or spayed, and Ten (\$10.00) Dollars per year for each year of the license term for an unneutered male cat or unspayed female cat. For the license term commencing January 1, 2013, the cat license fee shall be Ten (\$10.00) Dollars per year of each year of the license term for a neutered male cat or spayed female cat, upon presentation of evidence that the cat is neutered or spayed, and Twenty-Five (\$25.00) Dollars per year for each year of the license term for an unneutered male cat or unspayed female cat. Effective July 1, 2013, the cat license tax shall be Fifteen Dollars (\$15.00) for a neutered male or spayed female cat, upon presentation of evidence that the cat is neutered or spayed, and Thirty-five Dollars (\$35.00) for an unneutered male cat or unspayed female cat. License fees shall not be prorated or refunded when the license was effective for a portion of a license year.

4. Late Fee. A late fee of Five (\$5.00) Dollars shall be paid to the City Clerk or collecting official by every owner of a cat five (5) months of age or over, if the owner failed to obtain a license prior to April 1st of each year, or within thirty (30) days of acquiring ownership of a licensable cat or if the owner failed to obtain a license on or before the cat reached licensable age.

5. Special Revenue Fund. The Finance Director shall create a special revenue fund for the purposes of depositing the licensing and/or late fees collected. The special revenue fund shall be used to further the purpose of this Chapter and support the canine unit(s) of the Kenosha Police Department. Requests for funds shall be reviewed and approved by the Finance Committee.

C. Nuisance. No person shall keep or harbor within the City any dog which by loud or frequent or habitual barking, yelping, or howling shall cause serious annoyance to the neighborhood or to persons passing to and from upon the streets. No owner or a person harboring a fierce or vicious dog shall suffer the same to run at large at any time within the City.

D.1. Run at Large. It shall be unlawful for any person owning or possessing any dog or cat to permit it to run at large. "Run at Large" shall mean the presence of an animal which is not on a secured leash of six (6') feet or less on any public property or thoroughfare or on any private property without the permission of the property owner or occupier. Dogs and cats which are not leashed in vehicles are not deemed to "run at large" if

CODE OF GENERAL ORDINANCES, 2021 - KENOSHA, WISCONSIN

they are secured in a manner as will prevent their escape therefrom. This requirement does not apply to dogs utilized for law enforcement purposes.

2. Impounding. Whenever a City Humane Agent or any police officer or other person designated by the Chief of Police shall find any dog or cat running at large as defined, he/she shall, if possible, pick up and impound such animal in such place as the Chief of Police may direct; provided, however, that if any such dog or cat is dangerous, it may be disposed of forthwith. Whenever the owner of any impounded animal shall be identifiable through a collar or license tag or microchip, the owner shall be notified by the impoundment facility.

Any animal impounded shall be held for a period of four (4) days to permit the owner to reclaim it. At the end of such period, the animal may be disposed of in the manner as provided by Wisconsin Statutes.

3. Public Dog Runs. Persons owning or possessing a dog may permit it to run without it being on a secured leash of six (6) feet or less on Retaining Basins located on the west side of 39th Avenue between Bradford High School and Bullen Junior High School and on the south side of 18th Street between 26th Avenue and 24th Avenue, in said persons presence, daily, between the hours of 6:00 A.M. and 10:00 A.M. and between the hours of 5:00 P.M. and 8:00 P.M. It shall be unlawful for any person to permit a dog to be present upon either of said Retention Basins at any other time.

14.012 MANAGED CARE OF FERAL CATS

A. Responsibilities of Owners of Domesticated Cats.

1. Owners of domesticated cats shall provide appropriate and adequate food, water and shelter for their cats.

2. The owner of a domesticated cat shall exercise reasonable care to guard against the cat creating a nuisance.

3. Owners of domesticated cats shall not permit their cats to roam unsupervised off their property.

4. An owner shall not abandon a domesticated cat.

B. Community Cat.

1. Community Cats shall be permitted and Feral Cat Caretakers shall be entitled to maintain and care for Feral Cats by providing food, water, shelter and other forms of sustenance, provided that the Community Cats are registered with a Department approved Sponsor, and that the Community Cat Caretaker takes all appropriate and available steps to meet the terms and conditions of this Ordinance.

2. Sponsorship of TNR Programs. Any animal Humane Society that agrees to comply with the requirements of this Ordinance for Sponsors shall be eligible to act as a Sponsor. Any Humane Society intending to undertake the responsibilities of Sponsor shall so advise the Department in writing and provide its address and telephone number, and electronic mail address if applicable.

3. Sponsor Requirements. It shall be the duty of the Sponsor to:

(a) Review and, in its discretion, approve of Community Cat Caretakers.

(b) Help to resolve any complaints over the conduct of a Community Cat Caretaker or the cat.

(c) Maintain records provided by Community Cat Caretakers on the location as well as the vaccination, micro-chipping, and spay and neuter records of Community Cats.

(d) Provide, at a minimum, written educational training for all Caretakers addressing uniform standards and procedures for cat maintenance.

(e) Use due consideration to prevent Community Cats from being maintained on lands managed for wildlife or other natural resources where the presence of Community Cats is a proven threat, and to avoid the taking of rare, threatened or endangered species under the Wisconsin Endangered Species Protection Act of 1972.

CODE OF GENERAL ORDINANCES, 2021 - KENOSHA, WISCONSIN

(f) Provide any forms or other documentation necessary to allow Community Cat Caretakers to receive any public or private subsidies, medical care or other forms of assistance for their Community Cat which may be available to them.

4. Community Cat Caretaker Responsibilities. In order to be an approved managed Feral Cat Caretaker, said Caretakers shall be responsible for the following:

(a) Registering the cat with the Sponsor.

(b) To vaccinate the cat for rabies, preferably with a three-year vaccine and to update the vaccinations as warranted and mandated by law.

(c) To have the cat spayed or neutered by a licensed veterinarian.

(d) Ear tipping the left ear of the cat that has been vaccinated and spayed or neutered so that colony cats can be readily identified.

(e) Having a micro-chip inserted into the cat in accordance with professional medical standards. The Sponsor and the Community Cat Caretaker shall be the named contacts for purposes of the micro-chipping.

(f) Providing the Sponsor with descriptions of each cat and copies of documents demonstrating that the cats have been vaccinated, micro-chipped, and spayed or neutered.

(g) Providing food, water and, shelter for cat.

(h) Obtaining proper medical attention for any cat that appears to require it.

(i) Observing the cat at least twice per week and keeping a record of any illness or unusual behavior noticed in any cat.

(j) Obtaining the written approval of the owner of any property, or any authorized representative of the owner, to which the Caretaker requires access to provide care.

(k) **Withdrawal of Community Cat Caretaker or Sponsor.** In the event that a Community Cat Caretaker is unable or unwilling to continue in that role, he or she shall notify his or her Sponsor.

5. Disposition of Feral Cats. A Community Service Officer who has trapped a cat whose left ear has been tipped, indicating that it is a Feral Cat, shall release the cat back outside with permission of the person who has trapped it or if a nuisance bring to shelter.

C. Ordinance Enforcement.

1. The Department or its designee, in order to encourage the stabilization of the Feral Cat population in Kenosha County, shall have the following rights:

(a) The right to trap in a humane manner and remove any cats that (i) have not been vaccinated against rabies or which are demonstrating signs of the disease, (ii) are not spayed or neutered, (iii) are not identifiable through a micro-chip as being a Feral Cat that has a Sponsor and a Community Cat Caretaker, or (iv) for public health or public safety concerns.

If a Feral Cat is demonstrating signs of having rabies, or has an illness or injury that presents an imminent danger to the public health or safety, or to its own person, that cat shall be humanely destroyed.

(b) The right to direct that a Sponsor remove a Feral Cat that is creating a nuisance if the Sponsor has failed to adequately resolve the nuisance within 15 days after being given written notice thereof. In the event that the Department directs the Sponsor to remove the cat, the Sponsor shall have 15 days to do so. Failure of the Sponsor to remove the cat within said time period (or such longer time as the Department may specify) shall constitute grounds for the Department to remove the cat.

2. Community Service Officers ("CSO") or police officers shall investigate any nuisance complaint allegedly caused by a Feral Cat. In the event that a CSO or police officer finds that a Feral Cat has created a nuisance, the CSO or police officer shall advise the Sponsor in writing of the nuisance.

CODE OF GENERAL ORDINANCES, 2021 - KENOSHA, WISCONSIN

3. If a Sponsor fails to perform its responsibilities of this Ordinance, the Department may notify the Sponsor that it must comply with the requirements of this Ordinance within 15 days. If the Sponsor fails to do so, the Department may remove this Sponsor from the list of Department approved Sponsors, and may reassign the Feral Cats from this Sponsor to another Sponsor.

4. If a Community Cat Caretaker regularly fails to comply with this Ordinance, the Sponsor may notify the Community Cat Caretaker that he or she has 15 days to make all reasonable efforts to fulfill the responsibilities of this Ordinance. If the Feral Cat Caretaker fails to comply within that time period, the Sponsor may identify and obtain replacement Feral Cat Caretaker for the Feral Cat of the non-compliant Feral Cat Caretaker. If no other Feral Cat Caretaker can be found within 15 days, the Sponsor shall notify the Department, and the Department may humanely remove the Feral Cat and dispose of.

5. Community Cats who were spayed or neutered and vaccinated for rabies prior to the date on which this Ordinance became effective, but did not have an micro-chip inserted or were marked as Feral by some indication other than a left ear tip, shall be deemed to be in compliance with this Ordinance, if all other requirements are being met by their Community Cat Caretaker. Community Cat Caretakers shall take all appropriate and available steps to bring these cats into compliance with the provisions of this ordinance within three years of its enactment, or upon revaccination of the cats for rabies, whichever comes first.

14.013 LIMITATION ON NUMBER OF DOGS AND CATS PER RESIDENTIALLY ZONED LOT

A. Purpose. The owning, harboring and keeping by any person(s) of a large number of dogs, cats or combination thereof within a residentially zoned lot within the City for an extended period of time, detracts from the quality of life within the entire residential district due to various noise, odor, health and safety problems which constitute a public nuisance. The Common Council of the City of Kenosha, Wisconsin, has deemed it necessary to abate such public nuisance by the creation of the following limitation.

B. Limitation. No person may own, harbor or keep in their possession, within the City, more than three (3) dogs, cats or combination thereof, over the age of five (5) months, except when they possess a Kennel License which is in full force and effect.

C. Exemption. Any person owning, harboring or keeping in their possession within the City, on the effective date of this Ordinance, more than three (3) dogs, cats or combination thereof, over the age of five (5) months, shall be permitted to own, harbor or keep within their possession said dogs and/or cats provided that:

1. Required license fees for each dog have been paid, a license for each dog is continuously maintained in full force and effect, and proof thereof is furnished to City personnel empowered to enforce this Ordinance upon request.

2. Required and effective rabies immunization for each dog and/or cat has been procured, and effective level of rabies immunization continuously maintained, and proof thereof furnished to City personnel empowered to enforce this Ordinance upon request.

3. The premises upon which the dogs and/or cats are kept is maintained in accordance with **§14.014** of the Code of General Ordinances, and said compliance is demonstrated to City personnel empowered to enforce this Ordinance upon request.

However, this exemption shall not authorize the replacement of any dog and/or cat until the specified limitation within this Ordinance is complied with. The burden of proving entitlement to this exemption is upon the party seeking the exemption.

D. Pet Fancier Permit. Notwithstanding the provisions of subsection (B), it shall be lawful to keep up to five (5) dogs, cats or combination thereof, over the age of five (5) months if the owner complies with all of the following requirements:

1. Applies for and receives a pet fancier's permit from the Committee on Licenses and Permits.

2. Files with the City Clerk a fully executed application on a form prescribed by the City Clerk and pays a

CODE OF GENERAL ORDINANCES, 2021 - KENOSHA, WISCONSIN

non-refundable application permit fee of \$35.00.

3. Provides proof of a current license as defined by §14.01 for each animal covered by the permit.
4. Is not in violation or has not violated within the previous two (2) years, any provision of this chapter.
5. Does not have a conviction for cruelty, neglect or mistreatment of an animal.
6. Pet fancier's permits shall expire on December 31 each year.

7. The premises upon which the dogs and/or cats are kept is maintained in accordance with §14.014 of the Code of General Ordinances, and said compliance is demonstrated by city personnel empowered to enforce this Ordinance upon request; inspection of the premises and all animals located at the premises shall be permitted at any time.

8. When issued, a permit shall be kept upon the licenses premises and exhibited upon request to city personnel empowered to enforce this Ordinance.

9. Revocation, Suspension and Non-Renewal of Permit. Permits granted hereunder may be revoked, suspended, or not renewed for just cause, upon notice and an opportunity to be heard. The hearing shall be conducted by the Committee on Licenses/Permits.

10. Working dogs such as service dogs, medical alert dogs and certified therapy dogs (must have proof of accreditation) are not included in the pet limit calculation. However, they must remain licensed within the city.

14.014 MAINTENANCE OF SANITARY CONDITIONS

Any premises, whether indoors or outdoors, upon which any animal is harbored, shall be maintained in a sanitary condition, and all animal feces must be removed and sanitarly disposed of within twenty-four (24) hours.

14.015 KENNELS AND PET SHOPS

A. Definitions. The following definitions shall apply to the terms and words used in this Chapter:

1. **Kennels** means and includes:

a. Noncommercial Kennels. Any not for profit business that, as a home occupation, under the Zoning Ordinance, keeps, maintains, harbors or possesses more than three (3) dogs or cats, or combinations thereof, over five (5) months of age for the purpose of housing unwanted dogs and/or cats pending adoption. This term shall exclude the commercial sale and breeding of any such animals. However, the charging of a fee to cover costs for maintenance, health care, neutering and spaying shall not disqualify households from noncommercial kennel status.

b. Commercial Kennels. A for profit business establishment engaged in offering boarding, training and/or breeding services and/or the sale of dogs and/or cats, with the exclusion of veterinary hospitals. Commercial kennels shall include the boarding of dogs for racing purposes.

c. Humane Societies. An impoundment facility under §174.046, Wisconsin Statutes.

2. **Pet animal** means any domesticated or wild animal, including dogs, cats, birds, small rodents or small nonpoisonous reptiles, which is fed, watered, harbored or allowed, by City Ordinances, to be or remain in the City, excluding:

- a. Any hoofed animal.
- b. Any animal in a zoo, exhibition or fair authorized by City Ordinances.
- c. Any animal which is held for use in bona fide scientific research.

CODE OF GENERAL ORDINANCES, 2021 - KENOSHA, WISCONSIN

3. Pet shop means a retail or wholesale business offering for sale pet animals, excluding commercial kennels.

4. Enclosure(s) means a separate enclosure or cage which segregates one animal from another animal or animals.

5. Veterinary hospital means any establishment in which the practice of veterinary medicine is the primary business.

6. Sanitarian shall mean a Health Department Sanitarian and shall include Sanitarian Aide.

B. License Required/Fee. It is unlawful for any person, party, firm or corporation to operate, keep or maintain within the City limits a kennel or pet shop without first having obtained a license from the City Common Council and being in compliance with all provisions of this Ordinance. License applications shall be reviewed, prior to action by the Common Council, by the Committee on Licenses/Permits. The City Clerk, or designee thereof, shall issue licenses which have been granted by the Common Council. The fee for a license issued hereunder or renewal thereof shall be Two Hundred (\$200) Dollars per calendar year or fraction thereof.

C. License/Application.

1. Any applicant for a license or renewal thereof under this Ordinance shall file with the City Clerk a fully executed application on a form prescribed by the City Clerk, accompanied by the annual license fee. The application shall state the maximum number of dogs and/or cats sought to be permitted upon the licensed premises.

2. No licenses or renewal thereof shall issue hereunder until:

a. There has been an inspection by a Sanitarian of the premises being licensed and a determination by said Sanitarian that all requirements of this Ordinance, and other applicable General and Zoning Ordinances, have been met.

b. There is an adequate means of restraining animals from running at large or disturbing the peace.

c. The proposed facilities are located in an appropriate zone under the City Zoning Ordinance and are the subject of an Occupancy Permit, as verified by the Director of City Development, Department of City Inspections, or designee thereof.

d. The proposed facilities are in compliance with the Building Code and Fire Code, as verified by authorized representatives of enforcing departments.

3. Any license or renewal thereof issued hereunder shall be for a calendar year or portion thereof. Licenses must be renewed each calendar year on or before the thirty-first (31st) day of January. Licenses shall not be assignable or transferable either to another person, party, firm or corporation or for another location.

4. When issued, a license shall be displayed in a manner and at a location so as to be readily visible by the public.

5. The Common Council shall license the premises only for such number of dogs and/or cats as the premises to be licensed will reasonably accommodate based upon inspection reports.

D. License and Rabies Tags. Upon issuing a license hereunder, the City Clerk shall issue a number of tags equal to the number of dogs and/or cats authorized to be kept on the licensed premises. License tags shall be made in a form so that they may be readily distinguishable from the individual license tags for the same year. The licensee shall, at all times, keep one of such tags, plus a Rabies Tag obtained from a veterinarian, attached to the collar of each dog or cat over five (5) months old kept on the licensed premises. This requirement to wear a tag and collar does not apply to a dog during competition or training, a dog securely confined indoors, to a dog while hunting, or to a dog securely confined in a fenced area. License tags

CODE OF GENERAL ORDINANCES, 2021 - KENOSHA, WISCONSIN

may be transferred from one dog or cat to another. No dog or cat bearing any such license tag shall be permitted to stray or to be taken anywhere outside the limits of the licensed premises unless it is in leash, except where temporarily unleashed for the purposes of hunting, breeding, trial or show. Humane Societies shall follow the provisions of §174.046, Wisconsin Statutes.

E. Records. The City Clerk shall make a duplicate list of the names of licensees and the number of dogs kept upon each licensed premises and shall deliver one (1) copy of said list to the County Clerk, retaining the other copy for his/her files.

F. Chapter 174, Wisconsin Statutes. Unless clearly inapplicable, all the provisions of Chapter 174, Wisconsin Statutes, relating to the individual dog license tax, license and tag, shall apply to license tags issued hereunder.

G. Other Licenses and Permits. The issuance of a license hereunder does not exempt licensee from obtaining and complying with all other applicable State and City licenses and permits, including required Zoning Permits. Licensees who engage in commercial pesticide application must be licensed, certified and at all times maintain compliance with §94.704 and §94.705, Wisconsin Statutes, and §Ag 29.11 of the Wisconsin Administrative Code.

H. General Facility Standards. All licensed premises shall provide the following:

1. Water and food. Adequate and potable water shall be available at all times to pet animals. Watering and feeding receptacles shall be cleaned at least once daily.

2. Storage. Supplies of food and bedding shall be stored and adequately protected against infestation or contamination by vermin. Refrigeration shall be provided for perishable food.

3. Waste Disposal. Provisions shall be made for the removal and disposal of animal and food wastes, bedding, dead animals and debris. Disposal facilities shall also be provided and operated as to minimize vermin infestation, odors and disease hazards.

4. Washrooms and Sinks. Facilities such as washrooms, basins or sinks shall be provided to maintain cleanliness among caretakers.

5. Communicable Diseases. Pet animals with potential communicable diseases shall be housed in separate rooms from healthy, boarding animals. Pet animals which have a communicable disease shall not be sold or provided for adoption until receiving a clean bill of health from a veterinarian.

6. Vicious Animals. Vicious animals, as defined in §14.075 of the Code of General Ordinances, shall not be kept on licensed premises.

I. Indoor Facility Standards. In addition to the requirements of Subsection H., indoor facilities licensed hereunder shall provide the following:

1. Ventilation. Indoor housing for pet animals shall be adequately ventilated to provide for health and comfort of said animals at all times. They shall be provided with fresh air, either by means of windows, doors, vents or air conditioning. Ventilation shall minimize drafts, odors and moisture condensation. Auxiliary ventilation such as exhaust fans and vents or air conditioning shall be provided when the ambient temperature is eighty-five (85°F) degrees Fahrenheit or higher, except where the ambient temperature requirements of the specific requirements of the specific species differs.

2. Lighting. Indoor housing for pet animals shall have ample artificial light which is of good quality and is well-distributed. Such lighting shall provide uniformly distributed illumination of sufficient intensity to permit routine inspection and cleaning during the entire working period.

3. Interior Surfaces. The interior building surfaces of indoor housing facilities for pet animals shall be constructed and maintained so that they are impervious to moisture and may be readily cleaned.

4. Drainage. A suitable method shall be provided to rapidly eliminate excess water from indoor housing

CODE OF GENERAL ORDINANCES, 2021 - KENOSHA, WISCONSIN

facilities. If drains are used, they shall be properly constructed and kept in good repair to avoid foul odors therefrom. If closed drainage systems are used, they shall be equipped with traps and so installed as to prevent any backup of sewage and odors,

5. Dogs Five (5) Months or Older. Dogs five (5) months or older which are housed longer than a twenty-four (24) hour period shall be provided with adequate, separate, cleanable enclosures and shall be permitted exercise periods at least twice each day for a minimum of five (5) minutes each period, unless an exercise run is provided. An exercise run must have an area of twenty (20) square feet for a dog of thirty (30) pounds or less, and a minimum of thirty-six (36) square feet for a dog over thirty (30) pounds in weight.

Subsection 3. shall not apply to noncommercial kennels.

J. Outdoor Facility Standards. In addition to the standards required under Subsection H., outdoor facilities licensed hereunder shall provide the following:

1. Shelter from sunlight. When sunlight is likely to cause overheating or discomfort, sufficient shade shall be provided to allow all pet animals kept outdoors to protect themselves from the direct rays of the sun.

2. Shelter from rain or snow. Pet animals kept outdoors shall be provided with access to shelter to allow them to remain dry during rain or snow.

3. Shelter from cold winter. Shelter shall be provided for all pet animals kept outdoors when the atmospheric temperature falls below fifty (50°F) degrees Fahrenheit. Sufficient clean bedding material or other means of protection from the weather elements shall be provided when the ambient temperature fall below that temperature to which any such animal is acclimated.

4. Drainage. A suitable method shall be provided to rapidly eliminate excess water.

5. Dogs five (5) months or older. Dogs five (5) months or older which are housed longer than a twenty-four (24) hour period shall be provided with adequate, separate, cleanable enclosures and shall be permitted exercise periods at least twice each day for a minimum of five (5) minutes each period, unless an exercise run is provided. An exercise run must have an area of twenty (20) square feet for a dog of thirty (30) pounds or less, and a minimum of thirty-six (36) square feet for a dog over thirty (30) pounds in weight.

6. Individual enclosures. Individual enclosures shall not be required for noncommercial kennels.

K. Enclosures. Enclosures shall:

1. Not be required for noncommercial kennels.

2. Be structurally sound and maintained in good repair to protect the pet animals from injury, to contain them, and to keep predators out. They shall be constructed of a material that is easily cleanable and maintained so as to enable the pet animals to remain dry and clean and provide convenient access to clean food and water.

3. Be constructed and maintained so as to provide sufficient space to allow each pet animal to turn about freely and to easily stand, sit and lie in a comfortable, natural position.

4. Be used for housing not more than one (1) pet animal unless requested by the owners of each pet animal housed therein.

5. Subsections 3. and 4. above shall not apply to pet animals being housed for medical or grooming purposes, or for less than seventy-two (72) hours.

L. Sanitation/cleaning of Enclosures.

1. Excreta shall be removed from enclosures as often as necessary to prevent contamination of the pet animals contained therein and to reduce disease, hazards and odors. When a hosing or flushing method is used for cleaning and enclosure, the pet animals shall be removed during the cleaning process and adequate measures shall be taken to protect the pet animals in other enclosures from being contaminated with water

CODE OF GENERAL ORDINANCES, 2021 - KENOSHA, WISCONSIN

and other wastes.

2. Enclosures, rooms, hard-surfaced pens and runs shall be cleaned by washing all soiled surfaces with a safe and effective disinfectant.

3. Pens and runs shall be constructed of concrete, asphalt or impervious material, or other material approved by the Health Administrator or his or her designee.

4. An effective program for the control of insects, ectoparasites, avian and mammalian pests shall be established and maintained where a problem.

M. Feeding.

1. Pet animals which are housed for more than twenty-four (24) hours shall be fed at least once a day, except as otherwise might be required to provide adequate veterinary care. The food shall be free from contamination, wholesome, palatable and of sufficient quality and nutritive value to meet the normal daily requirements for the condition and size of each pet animal.

2. Food receptacles shall be accessible to the pet animal and shall be located so as to minimize contamination by excreta. Feeding pans shall be durable and kept clean. The food receptacles shall be cleaned daily. Disposable food receptacles may be used, but must be discarded after each feeding. Self-feeders may be used for the feeding of dry food and they shall be sanitized as needed, but at least once per week, to prevent molding, deterioration or caking of feed.

N. Enforcement.

1. Any person, party, firm, or corporation who violates any of the provisions of this Ordinance, or shall hinder, impede or obstruct an enforcing officer in the performance of his/her duty of enforcement shall, upon conviction thereof, forfeit not more than Three Hundred (\$300) Dollars, plus the cost of prosecution.

2. Sanitarians within the Health Department shall be responsible for the enforcement of this Ordinance, and shall have the authority and duty to enter any licensed premises during regular business hours to inspect the same, with respect to businesses open at least forty (40) hours per week. In the absence of regular business hours, inspections shall be made at any reasonable hour. In the event of an emergency, an inspection may be made at any time.

3. The provisions of this Ordinance which are enforceable against a licensee shall be equally enforceable against a non-licensee who is required to be licensed hereunder.

O. Suspension, Revocation or Denial of Renewal of License.

1. The City Common Council shall have the right to suspend or revoke any license once granted or deny annual renewal thereof when it appears that any operator or licensee has violated any of the provisions of this Ordinance, or any Ordinance of the City, or law, rule or regulation of the State of Wisconsin or the United States, involving cruelty or mistreatment of pet or other animals, or the unlawful possession of any animal. Prior to the suspension or revocation of any license or the denial of an application for a renewal thereof, written notice of the reason for such action shall be given to the applicant or licensee by the City Clerk. Such notice shall state that the applicant or licensee may request a hearing on such decision by the City Common Council within ten (10) days of receiving the notice.

2. Should the applicant or licensee request a hearing within such ten (10) day period, the applicant or licensee shall be notified in writing by the City Clerk of the time and place of the hearing, and the license shall remain in effect until the City Common Council determines that grounds exist for such action.

3. Disciplinary hearings, including nonrenewal, suspension and revocation hearings, shall be held before the Committee on Licenses/Permits, which shall submit a report to the Common Council, including Findings of Fact, Conclusions of Law and a recommendation as to what action, if any, the Common Council should take with respect to the License. The Committee shall provide the Complainant and the Licensee with a copy of the

CODE OF GENERAL ORDINANCES, 2021 - KENOSHA, WISCONSIN

report. Either the Complainant or the Licensee may make an objection, orally or in writing, to the report and shall have the opportunity to present arguments supporting the objection to the Common Council. The Common Council shall determine whether the arguments shall be presented orally or in writing, or both. If the Common Council, after considering the Committee's report and any arguments presented by the Complainant and Licensee, finds the complaint to be true, or if there is no objection to a report recommending a suspension, revocation or nonrenewal, the Licensee shall be suspended, revoked or not renewed as provided by law. If the Common Council finds the complaint untrue, the proceedings shall be dismissed without cost to the accused. The City Clerk shall give notice of each suspension, revocation or nonrenewal to the party whose License is affected.

14.02 CERTAIN ANIMALS PROHIBITED; FOWLS REGULATED

A. No person, party, firm or corporation shall, keep, feed or breed any swine, cattle, foxes, beavers, mink, otter, martin, fisher, raccoon, skunk, goats, horses, mules, asses, sheep, pheasants, poultry or bees in the City, except as herein provided. In the A-1 and A-2 Zoning Districts, swine, cattle, goats, horses, sheep, poultry or bees are permitted upon first obtaining a permit from the Administrator of Health, or designee thereof. In the event of the commercial raising of poultry for meat or eggs, a license, as provided in Subsection B., shall be required. The above referenced permit may be conditioned upon said animals being kept in such manner so as to not constitute a public nuisance or a health hazard. Said permit shall limit the number of animals and impose fencing, setback and maintenance requirements such as are necessary to promote health and sanitation. Vietnamese Potbellied Pigs are allowed in one and two family residential housing units in other than the A-1 and A-2 Zoning Districts, upon the issuance and maintenance of a license therefor under §14.024 of the Code of General Ordinances. Notwithstanding the above, killer bees of the African or South American species may not be kept, fed or bred in the City under any circumstances.

Nor shall any person, firm or corporation bring into, keep or maintain under their control, within the limits of the City, any wild animal or any animal which may endanger life or property. The word "**animal**" as used in this subsection is any living thing that is not human or a plant, and generally is capable of voluntary motion or sensation, and, the term "wild animal" includes, but is not limited to, all animals not indigenous to the North American Continent, and having a dangerous propensity.

Any traveling circus or similar business having suitable structures or facilities for the safeguard of such animals as determined by the City Humane Officer are exempted from the provisions of this subsection.

Also excepted from this Ordinance is any bona fide, accredited school having structures or facilities for the safekeeping of such animals, as deemed appropriate by the City Health Administrator, or designee thereof, and offering protection to persons who may come in contact therewith, providing the head of the school or school system authorizes the keeping or maintaining of designated animals, for educational purposes.

B. Fowls.

1. No person, firm, or corporation shall keep, feed, or harbor any chickens, turkeys, ducks, or geese without first obtaining a license so to do from the Common Council as hereinafter provided.

2. License. Application to operate a poultry ranch shall be made to the City Clerk and subject to the approval of the Common Council accompanied by a fee of \$200.00. Such application shall state the location of the ranch, its size, approximate acreage and number of fowl maintained per day. The license term shall be the calendar year. No license shall be granted for any premises not in conformity to the Zoning Ordinance.

3. Regulations.

- a.** The licensee shall not knowingly permit any live fowl within 125 feet of the boundaries of the premises.
- b.** The licensee shall maintain the premises in a sanitary condition such as to prevent obnoxious odors from escaping to any private or public property and such as to not jeopardize the public health, safety and welfare.

CODE OF GENERAL ORDINANCES, 2021 - KENOSHA, WISCONSIN

c. The licensee shall permit the inspection of the premises by the Health Department, and obey any reasonable sanitation directive of that Department.

4. Revocation of License. Upon recommendation of the Department of Health, the Council may revoke any license after a hearing has been afforded to the licensee.

14.024 VIETNAMESE POTBELLIED PIG LICENSE

A. Definitions.

1. Vietnamese Potbellied Pig shall mean purebred Vietnamese Potbellied Pigs registered through a North American Vietnamese Potbellied Pig Registry which do not exceed one hundred (100) pounds in weight.

2. Sanitarian shall mean a Kenosha County Health Department Sanitarian and shall include Sanitarian Aide, acting as the City enforcing agent under the provisions of a contract between the City and County.

B. License Required/Fee. It is unlawful for any person, party, firm or corporation to keep or maintain within the City limits a Vietnamese Potbellied Pig without first having obtained a license from the City Common Council and being in compliance with all provisions of this Ordinance. License applications shall be reviewed, prior to action by the Common Council, by the Committee on Licenses/Permits. The City Clerk, or designee thereof, shall issue licenses which have been granted by the Common Council. The fee for a license issued hereunder or renewal thereof shall be One Hundred (\$100) Dollars per calendar year or fraction thereof. Excepted from the license requirement is any law enforcement agency or agency under contract with the City to care for stray or unwanted animals.

C. License/Application.

1. Any applicant for a license or renewal thereof under this Ordinance shall file with the City Clerk a fully executed application on a form prescribed by the City Clerk, accompanied by the annual license fee.

2. No licenses or renewal thereof shall issue hereunder until:

a. A Certificate of Purebred registration is filed with the City Clerk.

b. There has been an inspection by a Sanitarian of the premises being licensed and a determination by said sanitarian that all requirements of this Ordinance, and other applicable General and Zoning Ordinances, have been met.

c. There is an adequate means of restraining animals from running at large or disturbing the peace.

d. The proposed facilities are located in an appropriate zone under the City Zoning Ordinance and are the subject of an Occupancy Permit, as verified by the Director of City Development, Department of City Inspections, or designee thereof.

e. The proposed facilities are in compliance with the Building Code and Fire Code, as verified by authorized representatives of enforcing departments.

3. Any license or renewal thereof issued hereunder shall be for a calendar year or portion thereof. Licenses must be renewed each calendar year on or before the thirty-first (31st) day of January. Licenses shall not be assignable or transferable either to another person, party, firm or corporation or for another location.

4. When issued, a license shall be kept upon the licensed premises and exhibited, upon request, to any City personnel requesting to examine it and having authority to enforce this Ordinance.

5. The Common Council shall license the premises only for one (1) Vietnamese Potbellied Pig.

D. License Tags. Upon issuing a license hereunder, the City Clerk shall issue a license tag. The licensee shall, at all times, keep such tag attached to the collar of said Vietnamese Potbellied Pig kept on the licensed premises. No Vietnamese Potbellied Pig shall be permitted to stray or to be taken anywhere

CODE OF GENERAL ORDINANCES, 2021 - KENOSHA, WISCONSIN

outside the limits of the licensed premises unless it is in leash, except where temporarily unleashed for the purpose of show.

E. Records. The City Clerk shall retain a copy of the application and license for his/her files.

F. Other Licenses and Permits. The issuance of a license hereunder does not exempt licensee from obtaining and complying with all other applicable State and City licenses and permits, including required Zoning Permits.

G. License Requirement. Licensee shall comply with the following as a condition of obtaining and maintaining a license:

1. Animal feces to be collected on a daily basis and stored in a sanitary receptacle. Animals shall not be brought, or permitted to be, on property, public or private, not owned or possessed by the owner or person in charge of the animal, unless such person has in his/her immediate possession an appropriate device for scooping excrement and an appropriate depository for the transmission of excrement to a receptacle located upon property owned or possessed by such person.

2. When sunlight is likely to cause overheating or discomfort, sufficient shade shall be provided to allow an animal kept outdoors to protect itself from the direct rays of the sun.

3. An animal kept outdoors shall be provided with access to shelter to allow it to remain dry during rain or snow. Animals may be kept outdoors only if contained in a fenced enclosure sufficient for purposes of restraint.

4. When the atmospheric temperature is less than fifty (50°) degrees Fahrenheit, an animal shall be kept indoors at a temperature no less than fifty (50°) degrees Fahrenheit, except for temporary ventures which do not endanger the animals health.

5. An effective program for the control of insects, ectoparasites, avian and mammalian pests shall be established and maintained where a problem.

6. Animals shall be fed and watered at least once a day, except as otherwise might be required to provide adequate veterinary care. The food shall be free from contamination, wholesome, palatable and of sufficient quality and nutritive value to meet the normal daily requirements for the condition and size of the animal. Food receptacles shall be accessible to the animal and shall be located so as to minimize contamination by excreta. Feeding pans shall be durable and kept clean. The food receptacles shall be cleaned daily. Disposable food receptacles may be used, but must be discarded after each feeding.

Self-feeders may be used for the feeding of dry food and they shall be sanitized as needed, but at least once per week, to prevent molding, deterioration or caking of feed.

7. Animals may not be permitted to exceed one hundred (100) pounds in weight.

8. Animals shall be examined by a veterinarian within a period of sixty (60) days prior to a new or renewal license application being filed. The animal may be licensed only upon a written statement from a veterinarian as to:

a. The animal's weight.

b. The animal has received all recommended vaccinations and boosters.

c. The animal is asymptomatic respecting disease or has a disease which is not contagious and is receiving appropriate treatment.

d. The animal's tusks, if any, have been removed or trimmed so as not to endanger any person or animal.

e. The animal has been spayed or neutered.

CODE OF GENERAL ORDINANCES, 2021 - KENOSHA, WISCONSIN

f. The animal has passed a pseudorabies test administered in accordance with Ag10, Wisconsin Administrative Code.

9. The animal shall not be permitted to "Run at Large". "Run at Large" shall mean the presence of an animal which is not on a leash of six (6') feet or less on any public property or thoroughfare or on any private property without the permission of the property owner or occupier. Animals which are not leashed in a motor vehicle shall not be deemed to "Run at Large" if secured in a manner as will prevent their escape therefrom.

10. Animals shall not be kept in a manner as to disturb the peace of the neighborhood or of persons passing to and from upon the streets.

11. License holder shall be responsible for all costs of impounding the animal, if taken into custody as a stray, and for all costs of providing any necessary medical treatment which may be required for the animal under any circumstances. To guarantee the payment of said cost, a bond, cash bond or other assurance approved by the City Attorney is required to be posted with the City Clerk in the amount of One Thousand (\$1,000) Dollars.

12. Animals may be imported, sold and exhibited only in accordance with Ag11, Wisconsin Administrative Code.

H. Enforcement.

1. Any person, party, firm, or corporation who violates any of the provisions of this Ordinance, or shall hinder, impede or obstruct an enforcing officer in the performance of his/her duty of enforcement shall, upon conviction thereof, forfeit not more than Three Hundred (\$300) Dollars, plus the cost of prosecution.

2. Sanitarians shall be responsible for the enforcement of this Ordinance, and shall have the authority and duty to enter any licensed premises to inspect the same. Inspections may be made at any reasonable hour. In the event of an emergency, an inspection may be made at anytime.

3. The provisions of this Ordinance which are enforceable against a licensee shall be equally enforceable against a non-licensee who is required to be licensed hereunder.

I. Suspension, Revocation or Denial of Renewal of License.

1. The City Common Council shall have the right to suspend or revoke any license once granted or deny annual renewal thereof when it appears that any licensee has violated any of the provisions of this Ordinance, or any Ordinance of the City, or law, rule or regulation of the State of Wisconsin or the United States, involving cruelty or mistreatment of the animal, or the unlawful possession of the animal. Prior to the suspension or revocation of any license or the denial of an application for a renewal thereof, written notice of the reason for such action shall be given to the applicant or licensee by the City Clerk. Such notice shall state that the applicant or licensee may request a hearing on such decision by the City Common Council within ten (10) days of receiving the notice.

2. Should the applicant or licensee request a hearing within such ten (10) day period, the applicant or licensee shall be notified in writing by the City Clerk of the time and place of the hearing, and the license shall remain in effect until the City Common Council determines that grounds exist for such action.

3. Disciplinary hearings, including nonrenewal, suspension and revocation hearings, shall be held before the Committee on Licenses/Permits, which shall submit a report to the Common Council, including Findings of Fact, Conclusions of Law and a recommendation as to what action, if any, the Common Council should take with respect to the License. The Committee shall provide the Complainant and the Licensee with a copy of the report. Either the Complainant or the Licensee may make an objection, orally or in writing, to the report and shall have the opportunity to present arguments supporting the objection to the Common Council. The Common Council shall determine whether the arguments shall be presented orally or in writing, or both. If the Common Council, after considering the Committee's report and any arguments presented by the Complainant and Licensee, finds the complaint to be true, or if there is no objection to a report recommending a suspension, revocation or nonrenewal, the License shall be suspended, revoked or not renewed as provided

CODE OF GENERAL ORDINANCES, 2021 - KENOSHA, WISCONSIN

by law. If the Common Council finds the complaint untrue, the proceedings shall be dismissed without cost to the accused. The City Clerk shall give notice of each suspension, revocation or nonrenewal to the party whose License is affected.

14.025 HORSE DRAWN VEHICLES/LICENSE AND PERMIT - OTHER ANIMAL DRAWN VEHICLES PROHIBITED

A. Definition. "Horse Drawn Vehicle" shall mean any surrey, carriage, wagon, cart or similar device which is pulled by one (1) or more horses, for any purpose, which is operated upon any public property or right-of-way.

B. License Required. It shall be unlawful for any person, party, firm or corporation to operate a Horse Drawn Vehicle within the City without first obtaining a license therefor as hereinafter prescribed or without first obtaining a Special Event Permit pursuant to Section 12.06 of the Code of General Ordinances.

1. Annual License. Annual Licenses shall be issued by the Common Council to eligible applicants, who make proper application to the City Clerk and tender the full application fee.

a. Term. The License term shall be January 1 through December 31 of each year.

b. Fee. The License fee shall be One Hundred Fifty (\$150) Dollars, which shall be proratable for first year licenses to the extent that the fee shall be reduced to Seventy-five (\$75) Dollars for any first year license which is effective for six (6) months or less.

c. Vehicles. The License shall cover one (1) vehicle. Additional vehicles may be included at an additional License fee of Twenty-five (\$25) Dollars per vehicle.

2. Daily Permit. Daily, nonrefundable Permits shall be issued by the City Clerk to eligible applicants who make proper application to the City Clerk and tender the full application fee.

a. Term. The Permit term shall be one (1) calendar day, as designated.

b. Fee. The Permit fee shall be Twenty-five (\$25) Dollars per day. Each day shall be considered a separate term.

c. Vehicle. Each vehicle shall require a separate Permit.

C. License/Permit Conditions. Applicants must comply with the following as a condition of a License/Permit being granted:

1. Applicant or partners or officers must be a minimum of eighteen (18) years old.

2. Applicant must submit with the application and maintain throughout the License/Permit term, an insurance policy written by one (1) or more insurers licensed to do business in the State of Wisconsin, in the amount of One Hundred Thousand (\$100,000) per person and Three Hundred Thousand (\$300,000) per occurrence, covering death, personal injury and property damage.

3. Applicant must own or lease a vehicle which is roadworthy and in a good state of repair.

4. Applicants for a License must submit a statement from a veterinarian that the horse(s) to be utilized are in good health. With respect to a Permit, applicant, if no such report is available, may sign a statement that to the best of his/her knowledge, the horse(s) to be utilized are in good health.

D. General Operating Requirements. Horse drawn vehicles shall be operated, at all times while within the City, in accordance with the following requirements:

1. Vehicles shall be roadworthy, in good repair, and in a clean, safe and sanitary condition.

2. Horses utilized to pull vehicles shall be in good health, sufficient to safely accomplish said task.

3. Vehicles shall be in compliance with Chapter 347, Wisconsin Statutes, with respect to lamps,

CODE OF GENERAL ORDINANCES, 2021 - KENOSHA, WISCONSIN

identification emblem, and slow-moving vehicle signs.

4. Horses shall be diapered to retain deposits of urine and fecal matter, and vehicles shall contain equipment to clean up same. Urine and fecal matter must be cleaned up promptly so as not to be a nuisance or health hazard.

5. Operators must be eighteen (18) years of age or older and have a valid Wisconsin Driver's License, except in the case of an individual who is a member of a branch of the Armed Services, having a valid driver's license from the State he/she declares as his/her residence, and residing within Kenosha County while in service.

6. Operators may not obstruct vehicular or pedestrian traffic or create a nuisance.

7. Operators shall not permit any passenger to sit alongside the driver while the vehicle is moving.

8. Operators may not operate any vehicle in excess of the weight and/or passenger capacity which it is built to accommodate.

9. Operators may not operate the vehicle between the hours of 7:00 A.M. to 9:00 A.M. and 3:00 P.M. to 6:00 P.M., Monday through Friday on the following streets: 52nd Street, from Sheridan Road to 30th Avenue; 22nd Avenue, from Washington Road to 75th Street; Sheridan Road, from Washington Road to 75th Street; and 75th Street, from Sheridan Road to 30th Avenue.

10. Operators shall obey the Rules of the Road for motor vehicles with respect to the operation and parking of motor vehicles.

E. Revocation, Suspension and NonRenewal of Licenses/Permits. Licenses/Permits granted hereunder may be revoked, suspended, or not renewed for just cause, upon notice and an opportunity to be heard. With respect to Licenses granted hereunder, hearing shall be conducted by the Committee on Licenses/Permits.

F. Other Ordinances. Nothing in this Ordinance shall permit horses to be kept, bred or boarded within the City contrary to **§14.02**, Ordinances, although horses drawing vehicles may be fed in the City during periods of operation.

G. Other Animal Drawn Vehicles Prohibited. No vehicle shall be drawn by any animal other than a horse within the City on public property or on a street right-of-way, with the exception of a parade or special civic event and the obtaining of a daily Permit hereunder.

14.03 SANITATION

A. All places and structures wherein any animal, fowl or bird is kept shall be maintained in a clean and sanitary condition and shall at all times be subject to inspection and such reasonable regulation as to its maintenance and location as the Department of Health may make.

B. It shall be unlawful for any person, except the visually or physically handicapped, to cause or permit a dog to be on property, public or private, not owned or possessed by such person unless such person has in his immediate possession an appropriate device for scooping excrement and an appropriate depository for the transmission of excrement to a receptacle located upon property owned or possessed by such person.

C. It shall be unlawful for any person in control of, except the visually or physically handicapped, causing or permitting any dog to be on any property, public or private, not owned or possessed by such person to fail to scoop and remove excrement left by such dog to a proper receptacle located on property owned or possessed by such person.

14.04 SALE OF BABY CHICKS, DUCKLINGS AND RABBITS

No person, firm or corporation shall sell, offer for sale, barter, display or give away baby chickens, ducklings, or other fowl, under three weeks of age, or rabbits under two months of age, as pets, toys,

CODE OF GENERAL ORDINANCES, 2021 - KENOSHA, WISCONSIN

premiums or novelties, or to color, dye, stain or otherwise change the natural color of said baby chickens, ducklings or other fowl, or rabbits; or to bring or transport the same into the City of Kenosha; provided, however, that this Section shall not be construed to prohibit the sale or display of said baby chickens, ducklings, or other fowl, or said rabbits in proper facilities by breeders or stores engaged in the business of selling for purposes of commercial breeding or raising for food. It shall be the burden of any person, firm or corporation charged with a violation of this Section to prove to the satisfaction of the court in which such case is heard the age, at the time of the alleged violation, of said baby chickens, ducklings, other fowl or rabbits.

14.05 OPEN LOFTS FOR PIGEONS PROHIBITED

D. No person, firm or corporation shall maintain or permit to be maintained on any property in the City an open loft for pigeons.

E. An open loft is defined to be a loft unattended by any person regulating the entrance and exit of pigeons, and which permits any pigeon regardless of ownership to enter and leave such loft freely at any time.

F. The prohibition in **A.** above shall not apply to racing lofts and racing pigeons, and said prohibition shall not apply or affect the basic rudiments of racing pigeon training.

14.055 CRUELTY TO ANIMALS

A. It shall be unlawful to willfully or maliciously inflict cruelty, torture, abuse or cruelly beat any animal, including every act or omission or neglect whereby unnecessary or unjustifiable pain, suffering or death shall be caused or withhold reasonably necessary veterinary care to prevent pain and suffering, whether belonging to himself or another except that reasonable force may be employed to drive off vicious or trespassing animals.

B. It shall be unlawful to fail or refuse or neglect to provide any animal in his charge with food, potable water, shade or shelter, or cruelly expose any animal in hot, stormy, cold or inclement weather or to carry any animal in or upon any vehicle in a cruel or inhumane manner.

1. In this Section, "**shade**" shall mean protection from the direct rays of the sun, during the months of June to September, inclusive, shall be provided.

2. In this Section, "**shelter**" shall mean a moisture proof structure of suitable size to accommodate the dog and allow retention of body heat, made of durable material with a solid floor raised at least two (2") inches from the ground and with the entrance covered by a flexible windproof material. Such structure shall be provided with a sufficient quantity of suitable bedding to provide insulation and protection against cold and dampness.

C. Tethering. No animal shall be tethered in a manner that endangers the animal's life or health by the use of a rope, chain or unconventional means of tethering.

14.06 TRAPPING

A. No person shall, within the corporate limits of the City of Kenosha, Wisconsin, set or operate any trap, device, or mechanism that is designed, built or made to close upon, hold fast or otherwise capture an animal, other than vermin.

B. This Ordinance shall not proscribe the use of "live" traps authorized under §29.24, Wisconsin Statutes, relating to the live trapping of certain animals by owners or occupants of land; use of live traps under §§29.425 and 29.427, Wisconsin Statutes, relating to relocation of live, wild animals; and the use of live traps under §29.59, Wisconsin Statutes, relating to the removal of wild animals causing damage.

14.07 RABIES CONTROL

A. Definitions. For the purpose of this Section, the following definitions shall apply:

1. Administrator. The term "Administrator" shall mean the Director of the Kenosha County Health

CODE OF GENERAL ORDINANCES, 2021 - KENOSHA, WISCONSIN

Department, and designees thereof, acting as the City enforcing agent under the provisions of a contract between the City and County of Kenosha.

2. Animal. The term "Animal" shall mean dog or cat.

3. Rabies Control Authority. The term "Rabies Control Authority" shall mean the Health Department of the County of Kenosha, Wisconsin.

4. Vaccination Against Rabies. The term "Vaccination Against Rabies" shall mean the inoculation of an animal with a rabies vaccine licensed by the United States Department of Agriculture administered by a veterinarian.

5. Veterinarian. The term "Veterinarian" shall mean a practitioner of veterinary medicine who is duly licensed by the State of Wisconsin.

B. Rabies Vaccination Required.

1. Rabies Vaccination Required. The owner of a dog or cat shall have the dog or cat vaccinated against rabies by a veterinarian, or if a veterinarian is physically present at the location where the vaccine is administered, by a veterinary technician, at no later than five (5) months of age and revaccinated within one (1) year after the initial vaccination. If the owner obtains the dog or cat, or brings the dog or cat into the City after the dog or cat has reached five (5) months of age, the owner shall have the dog or cat vaccinated against rabies within thirty (30) days after the dog or cat is obtained or brought into the City, unless the dog or cat has been vaccinated as evidenced by a current Certificate of Rabies Vaccination from the State of Wisconsin or another state. The owner of a dog or cat shall have the dog or cat revaccinated against rabies by a veterinarian, or if a veterinarian is physically present at the location where the vaccine is administered, by a veterinary technician, before the date that the immunization expires as stated on the certificate of vaccination, or if no date is specified, within three (3) years after the previous vaccination.

2. Exemption. The owner of a dog or cat may be exempt from the requirement to have the dog or cat vaccinated against rabies for a license year based on a letter from a veterinarian stating that vaccination is inadvisable because of a reaction to a previous vaccination, a physical condition, or a regimen of therapy that the dog or cat is undergoing. The owner shall provide a new letter for each year in which the owner seeks an exemption under this paragraph.

C. Duties of Veterinarian.

1. Issuance of Certificate of Rabies Vaccination. The person who administers the rabies vaccine under this Section shall complete and issue to the owner a Certificate of Rabies Vaccination bearing a serial number and in the form approved by the department stating the owner's name and address, the name, sex, spayed or unspayed, neutered or unneutered, breed and color of the dog or cat, the date of vaccination, the type of rabies vaccine administered and the manufacturer's serial number, the date that the immunization expires as specified for that type of vaccine by the Center for Disease Control of the U.S. Department of Health and Human Services, and the city, village or town where the dog or cat is required to be licensed.

2. Veterinarian Copies. The veterinarian shall keep a copy of each Certificate of Rabies Vaccination in a file maintained for this purpose until the date that the immunization expires or until the dog or cat is revaccinated, whichever occurs first.

3. Rabies Control Copy. Upon request of the Rabies Control Authority, the veterinarian shall forward a copy of each Certificate of Rabies Vaccination to the Rabies Control Authority within ten (10) days of the request.

4. Rabies Vaccination Tag. After issuing the Certificate of Rabies Vaccination, the person who administers the vaccine under this Section shall deliver to the owner a rabies vaccination tag of durable material bearing the same serial number as the certificate, the year the vaccination was given and the name, address and telephone number of the supervising veterinarian.

CODE OF GENERAL ORDINANCES, 2021 - KENOSHA, WISCONSIN

5. Tag To Be Attached. The owner shall attach the rabies vaccination tag or a substitute tag to a collar, and a collar with the tag attached shall be kept on the dog at all times, but this requirement does not apply to a dog during competition or training, to a dog while hunting, to a dog securely confined indoors, to a dog securely confined in a fenced area or to a dog while actively involved in herding or controlling livestock if the dog is under the control of its owner. The substitute tag shall be of a durable material and contain the same information as the rabies vaccination tag. The requirements of this Section do not apply to a dog which is not required to be vaccinated under **Section B.2**. No collar or harness shall be required for cats securely confined indoors or cats with a computer microchip encoded with identifying information which has been subcutaneously inserted within the cat.

6. Duplicate Tag. The person who administers the vaccine under **Section B.1**. may furnish a new rabies vaccination tag with a new serial number to an owner in place of the original tag upon presentation of the Certificate of Rabies Vaccination. The person who administers the vaccine under **Section B.1**. shall then indicate the new tag number on the certificate and keep a record in the file.

D. Vaccination Cost. The cost of rabies vaccination shall be borne by the owner of the dog or cat.

E. Exception of Vaccination Requirement - Transient Dog or Cats. The provisions of this Ordinance with respect to vaccination shall not apply to any dog or cat owned by a person temporarily remaining within the City of Kenosha for less than thirty (30) days, or any dog or cat brought into the City for field trial or show purposes, nor for hunting dogs in the State for less than 30 days. Such dogs shall be kept under strict supervision of the owner. However, it shall be unlawful to bring any dog into the City of Kenosha which does not comply with the animal health laws and import regulations of the State of Wisconsin, which are applicable to dogs.

F. Duty Upon Animal Biting or Scratching a Natural Person.

1. Within three (3) days after being notified as provided in **§2.**, the owner of an animal that has bitten or scratched any natural person, shall cause such animal to be examined by a veterinarian.

2. Notice, as used in **§14.07 F.**, shall be complete either:

a. Upon 1st class mailing of a notice; or,

b. Upon actual delivery of a notice to the owner.

c. By leaving a copy of the notice at the owner's usual place of abode within the State in the presence of some competent member of the family at least fourteen (14) years of age, who shall be informed of the contents thereof.

The notice herein shall be sufficient if it identifies: the animal, the name of the natural person bitten or scratched, the location at which the person was bitten or scratched, and the name of the owner (as defined in **§14.001 S.**) of the animal. Notice by mail shall be complete upon deposit with the Post Office.

3. In not less than ten (10) nor more than twelve (12) days after the date the animal bit or scratched any natural person, the owner shall secure a release of the animal from a veterinarian; on a form approved and supplied by the Rabies Control Authority and delivered by the owner to the Rabies Control Authority in not less than ten (10) nor more than twelve (12) days after the date the animal bit or scratched any natural person.

4. The owner of the animal shall cause the animal to be confined in the custody and care of a veterinarian for such period of time, not to exceed ten (10) days, as is deemed necessary by the veterinarian to determine whether the animal is rabid if:

a. Pursuant to the examination in **§1.**, the veterinarian determines that the animal exhibits abnormal symptoms, signs or behavior; or,

b. If the animal was not vaccinated pursuant to **§14.07 B.**. The cost of such confinement shall be paid by the owner.

CODE OF GENERAL ORDINANCES, 2021 - KENOSHA, WISCONSIN

5. If pursuant to the examination in §1., and subject to the conditions in §4., the veterinarian determines that the animal may be released to the owner, the owner shall continuously confine the animal within the owner's house or a locked pen or building completely inaccessible to children and from which the animal cannot escape, for a period of ten (10) days, commencing immediately after the bite or scratch.

6. If the owner fails to comply with the requirements of §§14.07 F.1., 3., 4., 5., 8., or 10., the animal, or its carcass, shall be impounded by order of the Administrator, for such period as shall be deemed necessary by the Administrator, to determine whether or not the animal is rabid. After the animal has been impounded for such period as is necessary to determine whether or not the animal is rabid, the Administrator, may cause such impounded animal to be returned to its owner. The return of the animal shall in no manner affect or diminish the liability of the owner for the costs of impounding and transporting the animal or relieve the owner of any duties or liabilities under this Chapter.

7. The owner shall comply with all the requirements of this Section each and every time an animal owned by him/her bites or scratches any natural person.

8. In the event the Rabies Control Authority notifies the owner later than ten (10) days after the animal has scratched or bitten a natural person, the owner shall have the animal examined by a veterinarian within three (3) days of the notice. The veterinarian may also release the animal pursuant to §14.07 F.3. at the same time the veterinarian makes the initial examination. If the veterinarian releases the animal immediately, it must be done on the same forms as required by §§14.03 F.1. and F.3., and delivered by the owner to the Rabies Control Authority within five (5) days after being notified. If the veterinarian determines that the animal is suspected of having rabies, the veterinarian shall confine the animal in the veterinarian's care for a period of not less than ten (10) days. The cost of such confinement shall be paid by the owner.

9. The owner of an animal shall not be relieved from any duty under this Section by reason of the animal's disappearance or by the transfer of its custody to another.

10. The owner shall not destroy or permit to be destroyed an animal that has bitten or scratched a natural person, unless it has been released pursuant to §14.07 F.3., or §14.07 F.8., or with the prior written permission of the Health Administrator, or fifteen (15) days have passed since the date of the last time the animal bit or scratched a natural person.

11. The City of Kenosha, upon failure of the owner to reimburse the veterinarian, shall reimburse veterinarian who confines an animal pursuant to a request for such confinement by the Administrator, under §14.07 F.4.b., 6. or 8. Such reimbursement shall be limited to the average normal customary charge in Kenosha County for boarding an animal by a veterinarian and up to two (2) rabies tests. The veterinarian, upon accepting reimbursement from the City under this Section, shall execute and deliver to the City an assignment of his/her claim against the owner for the costs of confinement. The City Attorney is authorized to take any and all actions he/she deems appropriate to collect the costs of confinement and care from the owner, pursuant to any assignment given by a veterinarian.

12. The Health Administrator may cause any dog impounded pursuant to §§14.07 F.5. or §14.07 F.6. to be vaccinated against rabies while such dog is impounded if such dog has not been and is required to be vaccinated under §14.07 B.

G. Handling of Dogs or Cats Bitten or Scratched by Rabid Animals. In the case of dogs or cats known to have been bitten or scratched by a rabid animal, the following shall apply:

1. Unvaccinated Dogs or Cats.

a. In the case of dogs or cats which are not vaccinated in accordance with §B. and which have been bitten or scratched by a known rabid animal, said bitten or scratched (exposed) dog or cat may be immediately destroyed, with the owner's consent, or as a last resort, if the cat or dog cannot be captured.

b. If the owner is unwilling to destroy the bitten or scratched (exposed) dog or cat, strict isolation of the dog or cat in a kennel under veterinary supervision for a minimum of 180 days, and compliance with the

CODE OF GENERAL ORDINANCES, 2021 - KENOSHA, WISCONSIN

vaccination requirement of Subsection 95.21(5)(c), Wisconsin Statutes, shall be required.

2. If the bitten or scratched (exposed) dog or cat is vaccinated in accordance with the provision of Section B. of this Ordinance, the dog or cat shall be handled as follows:

- a. Immediately revaccinated and confined for a period of sixty (60) days following revaccination; or,
- b. If the dog or cat is not immediately revaccinated, the dog or cat shall be confined in strict isolation in a kennel for six (6) months under the supervision of a veterinarian; or,
- c. The dog or cat shall be destroyed if the owner does not comply with item a. or b. of this Subsection 2.

H. Impoundment of Dogs Without a Valid Rabies Vaccination Tag.

1. Any dog found off the owner's premises and not wearing a valid rabies vaccination tag shall be impounded. All impounded dogs shall be given proper care and maintenance. Each impounded dog shall be kept and maintained at the pound in accordance with §14.01.

2. Notice of impoundment of all animals, including any significant marks of identification, shall be posted at the pound as public notification of impoundment. Any unvaccinated dog or cat may be reclaimed by its owners during the period of impoundment by payment of prescribed pound fees and complying with rabies vaccination requirement of this Ordinance within seventy-two (72) hours of release. Any vaccinated dog impounded because of lack of a rabies vaccination tag may be reclaimed by its owner by furnishing proof of rabies vaccination and payment of all impoundment fees prior to release.

I. Enforcement.

1. The Administrator, and his designees, shall be responsible for the enforcement of the provisions of this Section. The Humane Officer, his assistants, and all members of the Police Department, shall make themselves available to and follow the directions of the Health Administrator, or his designees to enforce this Section.

2. Upon a proper showing to the Administrator that a scratch of a natural person by an animal poses no threat of rabies to the person scratched due to the nature of the scratch, the Administrator may, upon a written finding, exempt the owner from the provisions of §14.07 F., except that the animal may not be destroyed for a period of not less than fourteen (14) days after the scratch was inflicted.

3. The Administrator is authorized to prepare and promulgate such forms as are necessary for the administration of §14.07, and is authorized to designate such persons as he/she deems appropriate to enforce §14.07. The Administrator shall be responsible for making any payments under §14.07 F.11.

K. Licensing. Effective April 15, 2007, in the City of Kenosha every dog five (5) months of age and older shall be licensed only upon proof of rabies vaccination in accordance with provisions of §14.07 B.

14.075 VICIOUS ANIMALS

A. Definitions.

1. "**VICIOUS ANIMAL**" shall mean:

a. Any animal that, when unprovoked, inflicts bites, injures, kills, damages or attacks a human being or domestic animal on either public or private property;

b. Any animal that has a propensity, tendency or disposition, known to the owner thereof, to attack, without provocation, in a manner which may cause death, injury, damage or which may otherwise endanger the safety of any human being or domestic animal; or,

c. Any animal trained or used for fighting against another animal.

Notwithstanding the definition of a "Vicious Animal" above, no animal may be declared vicious if death,

CODE OF GENERAL ORDINANCES, 2021 - KENOSHA, WISCONSIN

injury or damage is sustained by a person who, at the time such was sustained, was committing a criminal trespass upon premises occupied by the owner of the animal, or was teasing, tormenting, abusing or assaulting the animal, or was committing or attempting to commit a crime or violating or attempting to violate an Ordinance which protects person or property.

No animal may be declared vicious if death, injury or damage was sustained by a domestic animal which, at the time such was sustained, was teasing, tormenting, abusing, or assaulting the animal.

No animal may be declared vicious if the animal was protecting or defending a human being within the immediate vicinity of the animal from an unjustified attack or assault.

No dog may be declared vicious for acts committed by said dog while being utilized by a law enforcement agency for law enforcement purposes while under the control and direction of a law enforcement officer.

2. "PUBLIC PROPERTY" shall mean any property owned or controlled by any unit of government and open to the public, including streets, highways, sidewalks, right-of-ways, public ways and malls.

3. "OWNER" shall include any person who may own, possess, harbor, keep or maintain a "Vicious Animal".

B. Prohibition. No person shall own, possess, harbor, keep or maintain a "Vicious Animal" within the City of Kenosha, Wisconsin. Vicious Animals previously licensed within the City of Kenosha shall be removed from the City of Kenosha at the conclusion of the licensing period, and the location where said animal will be kept, harbored or maintained shall be disclosed to the Kenosha County Health Department.

C. Impoundment and Destruction. A "Vicious Animal" which is owned, possessed, harbored, kept or maintained in violation of this Ordinance may be impounded and destroyed by the City, or its agents at the expense of the owner, following notice and an opportunity to be heard by the Health Administrator. Any person or party aggrieved by such decision of the Health Administrator may appeal such decision to the Common Council by filing a written notice of appeal with the City Clerk/Treasurer within five (5) City business days of receipt of a written order from the Health Administrator. The "Vicious Animal" shall be impounded, but not destroyed, until the time for appeal has expired and until any timely appeal has been heard. A "Vicious Animal" shall not be released without identifying the location where said "Vicious Animal" will be kept upon release. The City elects not to be bound by Chapter 68, Wisconsin Statutes, with respect to administrative procedure.

D. Sale Or Transfer Of Possession.

a. No person may sell or transfer possession of a "Vicious Animal" to another person without first notifying the person to whom the "Vicious Animal" is being sold or transferred, of the fact that such is a "Vicious Animal", and of any requirements imposed upon the selling or transferring party by this Ordinance.

b. No person may sell or transfer possession of a "Vicious Animal" to another person without first notifying the City Clerk thereof, in writing, at least three (3) days in advance of the sale or transfer of possession.

E. Separate Offense. Each day of violation of any provision of this Ordinance and each violation of each provision of this Ordinance shall be deemed a separate offense.

14.076 ENFORCEMENT OF CHAPTER XIV AND CERTAIN STATE STATUTES

A. Statutes Incorporated By Reference. The following Wisconsin Statutes are incorporated herein by reference: Section 95.21, Chapter 173, Chapter 174, and Chapter 951.

B. Humane Officers; Appointment. The Common Council may appoint City employees or independent contractors or officers or employees of an independent contractor as Humane Officers under Section 173.03, Wisconsin Statutes, to perform Animal Control Services for the City.

CODE OF GENERAL ORDINANCES, 2021 - KENOSHA, WISCONSIN

C. Abatement of Violations Under Section 173.11, Wisconsin Statutes.

1. Issuance of Order. If a Humane Officer or law enforcement officer, after investigation, has reasonable grounds to believe that a violation of a Statute or Ordinance is occurring and the violation is causing or has the potential to cause injury to an animal, the Humane Officer or law enforcement officer may issue and serve an Order of Abatement directed to named persons. An official designated under **Subsection 3.** to hold a hearing may not participate in the decision to issue the order or in any activity leading to that decision.

2. Content of Order. An Abatement Order issued under Subsection 1. shall contain all of the following:

- (a) The name and address of the person to whom directed.
- (b) The statute or ordinance alleged to be violated.
- (c) A prohibition on further violations.
- (d) A description of measures necessary to correct the alleged violation.
- (e) A description of the hearing and appeal provisions under Subsections 3. and 4.

3. Hearing. Any person named in an Abatement Order issued under Subsection 1. may, within the ten (10) day period following service of the order, request a hearing before a Captain of the City of Kenosha Police Department by filing a request for hearing with the City of Kenosha Police Department at the Public Safety Building. The hearing shall be held within ten (10) days after the request is made, unless the requestor agrees to a later date. The hearing shall be informal in nature.

4. Decision. Within ten (10) days after a hearing under Subsection 3., the official who conducts the hearing shall affirm the order, modify and affirm the order, or withdraw the order.

5. Appeal. Any person adversely affected by a decision under Subsection 4. May seek judicial review by commencing an action in Circuit Court within thirty (30) days after the day that the decision is issued.

14.08 PENALTIES

A. Any person violating §14.01 A., shall forfeit Fifty (\$50.00) Dollars, together with the costs of the action, and in default of the payment of such forfeiture and costs, shall be committed to the County Jail for a period not to exceed thirty (30) days.

B. Any person violating §14.01 C. shall forfeit not less than Fifty (\$50.00) Dollars nor more than Two Hundred (\$200.00) Dollars, together with the costs of the action, and in default of payment of such forfeiture and costs, shall be committed to the County Jail for a period not to exceed thirty (30) days.

C. Any person convicted of violating §14.01 D. 1. or §14.01 D. 3. shall forfeit not more than Two Hundred (\$200) Dollars, together with the costs of the action, and in default of payment of such forfeiture and costs, shall be committed to the County Jail for a period not to exceed thirty (30) days.

D. Any person violating §14.02 shall forfeit One Hundred (\$100.00) Dollars, together with the costs of the action, and in default of the payment of such forfeiture and costs, shall be committed to the County Jail for a period not to exceed thirty (30) days.

E. Any person violating §14.03 shall forfeit Fifty (\$50.00) Dollars, together with the costs of the action, and in default of the payment of such forfeiture and costs, shall be committed to the County Jail for a period not to exceed thirty (30) days.

F. Any person violating §14.04 or §14.05 shall forfeit One Hundred (\$100.00) Dollars, together with the costs of the action, and in default of payment of such forfeiture and costs, shall be committed to the County Jail for a period not to exceed thirty (30) days.

G. Any person violating §14.055 shall forfeit not less than Two Hundred (\$200.00) Dollars nor more than

CODE OF GENERAL ORDINANCES, 2021 - KENOSHA, WISCONSIN

One Thousand (\$1,000.00) Dollars, together with the costs of the action, and in default of payment of such forfeiture and costs, shall be committed to the County Jail for a period not to exceed thirty (30) days.

H.1. Any person violating §14.07 B. shall forfeit Fifty (\$50.00) Dollars, together with the costs of the action, and in default of payment of such forfeiture and costs, shall be committed to the County Jail for a period not to exceed ninety (90) days.

2. Any person violating §§14.07 F. 1., 14.07 F. 5., 14.07 F. 8. or 14.07 F.10., shall forfeit not less than Two Hundred (\$200.00) Dollars, nor more than Five Hundred (\$500.00) Dollars, together with the costs of the action, and in default of payment of such forfeiture and costs, shall be committed to the County Jail for a period not to exceed thirty (30) days.

I.1. Any person violating §14.013 or 14.014 of this Chapter or any other provision of Chapter 14 for which there is no separately listed penalty, shall, upon conviction thereof, forfeit not less than One Hundred (\$100.00) Dollars nor more than Three Hundred (\$300.00) Dollars, plus the costs of prosecution, and in default of such payment of forfeiture and costs, shall be committed to the County Jail for a period not to exceed thirty (30) days.

2. Any person violating §14.013 D. of this Chapter shall, upon conviction thereof, forfeit not less than Three Hundred Fifty (\$350.00) Dollars nor more than Five Hundred (\$500.00) Dollars, together with the costs of the action, and in default of payment of such forfeiture and costs, shall be committed to the County Jail for a period not to exceed thirty (30) days.

J. Any person who violates §§14.06 A., 14.075 or 14.076 of this Chapter or Section 95.21, Chapter 173, Chapter 174, or Chapter 951, Wisconsin Statutes, shall, upon conviction, forfeit not more than Five Hundred (\$500.00) Dollars, together with the costs of prosecution, and in default of payment of such forfeiture and costs, shall be committed to the County Jail for a period not to exceed thirty (30) days.

K. For a first violation of any provision of §14.021 of this Chapter, a written warning will be issued. For the second and all subsequent violations of any provision of §14.021 of this Chapter, a person shall be subject to a forfeiture of not less than Five Dollars (\$5.00) nor more than Fifteen Dollars (\$15.00), together with costs of prosecution, assessments, fees, and surcharges for each offense, and upon default in payment, shall be imprisoned in the Kenosha County Jail for not more than 20 days, or otherwise treated by the court as provided by law.

L. Except as otherwise provided, anyone violating any of the provisions of this Chapter, upon conviction thereof, shall be subject to a forfeiture not to exceed One Thousand (\$1,000.00) Dollars, together with the payment of the costs of prosecution, assessments, fees, and surcharges, and in default of the timely payment thereof, shall either be committed to the County Jail for a period not to exceed ninety (90) days, or the Court may suspend the Defendant's motor vehicle operating privileges until the forfeiture, assessment, surcharges and costs are paid, except that the suspension period may not exceed five (5) years.

M. In addition to the imposition of a forfeiture, the City may seek injunctive relief.

N. Each incident and each day's continuance shall constitute a separate offense.

14.09 ENFORCEMENT

The provisions of this Chapter, except as otherwise provided, shall be enforced by the Humane Agent, Chief of Police and his designees and the Administrator and his designees.

14.10 SEVERABILITY

If any part of this Ordinance shall be held invalid, such part shall be deemed severable and the invalidity thereof shall not affect the remaining parts of this Ordinance.

CODE OF GENERAL ORDINANCES, 2021 - KENOSHA, WISCONSIN

CHAPTER XV SIGNS

15.01 PURPOSE

The purpose of the sign regulations of this Ordinance are to promote the effective use of signs as a means of communication; to maintain and enhance the aesthetic environment of the City; to promote pedestrian and vehicular safety; to protect property values by minimizing the adverse effects of signs; and to provide a procedure for fair and consistent enforcement. This purpose will be accomplished by:

- A. Establishing a permit system to allow a broad variety of sign types in commercially and industrially zoned districts and a limited variety of signs in other zoned districts, subject to the standards and procedures of this Ordinance.
- B. Allowing certain signs in residentially zoned districts that are small, unobtrusive and incidental to the principal use of the respective premises on which they are located, subject to the substantive requirements of this Ordinance, but without a requirement for permits.
- C. Prohibiting all signs not expressly permitted by this Ordinance.
- D. Prohibiting all signs which have the potential for disrupting or distracting vehicular traffic.
- E. Providing for the enforcement of this Ordinance.

15.02 DEFINITIONS AND INTERPRETATION

Words and phrases used in this Ordinance shall have the meanings set forth herein. All defined signs are on-premises signs except for billboards and signs described as off-premises signs. All defined signs are outdoor signs. Words and phrases not defined in this Ordinance, but defined elsewhere in the Zoning Ordinance or other provisions of the Code of General Ordinances of the City shall be given the meanings set forth therein. Descriptions of signs may include sign area and sign height. All other words and phrases shall be given their common, ordinary meaning, unless the context clearly requires otherwise. Section headings or captions are for reference purposes only and shall not be used in the interpretation of this Ordinance.

Abandoned Sign. A Sign which identifies or advertises a business, owner, operator, service or commercial activity, which is not operating or functioning, or a product which is not offered for sale.

Accessory Building. A detached building or structure on the same lot with, and of a nature customarily incidental and subordinate to the principal building or structure or the use of the land; i.e., garage, shed.

Animated. A Sign which imparts a state of light activity or movement, excluding an electronic message Sign.

Administrator. The Director of the Department of City Development, and designees authorized by the Director to administer and enforce this Ordinance.

Banner. A Sign which is not permanent and may be changeable, whether or not having an enclosing framework, which is mounted flush (having surfaces in same plane) to the principal building wall. Banners which are installed as a principal (main) Sign shall be considered permanent Signs when mounted to a building.

Beacon. A portable Sign which guides by light with one or more light beams directed into the atmosphere or directed at one or more points not on the same premise as the light source; also, a light source with one or more beams that rotate or move. Excluded herefrom is a beacon used as an aeronautical or navigational aid.

Billboard. An "Off-Premise" Sign.

CODE OF GENERAL ORDINANCES, 2021 - KENOSHA, WISCONSIN

Block. Determined by City approved Street address.

Building. A building or structure, whether or not occupied, located in any zoning district.

Building Marker. A permanent Sign attached to a building indicating the name of a building, date of construction and incidental information about its construction.

Canopy. A hoodlike cover, shelter or awning protection from rain or sun or decorative in nature containing a Sign projecting from a building extending over a door, entrance, window or outdoor service area, including a marquee Sign.

Changeable Copy. A Sign or portion of a Sign, with written representation, emblem, graphic, logo, symbol or other display that can be changed or rearranged without altering the face surface of the Sign, whether or not any display is periodically rearranged.

Commercial Message. Any written representation, emblem, graphic, logo, symbol or other display that names, advertises or references a business, operator, product, service or other commercial activity.

Construction. A Sign on a construction or demolition site identifying a construction or redevelopment project or parties participating in development or redevelopment of the premise on which the Sign is located.

Deteriorated. A Sign which is faded, tattered, broken, out of alignment, not fully functional or a blighting influence.

Directional/Information. A Sign that provides directions, instructions, or information and which may incidentally contain the name or logo of a business, owner or operator, but which excludes product and service related copy (i.e., parking or exit and entrance Signs).

Electronic Message. A Sign which provides changing or changeable messages in electronic format, which is not an animated Sign.

Electrical. A Sign or Sign structure in which electrical wiring, connections, or fixtures are used for display, lighting or any other purpose.

Exempt. A Sign which is exempt from the Sign Permit requirements of this Ordinance.

Festoons. Signs which shall include, but are not limited to, strings of ribbons, tinsel, small flags, pennants or pinwheels hanging between two points.

Flag. Any fabric, banner or bunting containing distinctive colors, patterns or symbols used as a symbol of government, political subdivision or other entity.

Flashing. A Sign, excluding Changeable Copy Signs and Electronic Message Signs, which contains any combination of devices that creates an illusion or sense of flashing light.

Freestanding. A Sign, independent from any buildings, supported by a pole or structures or supports that are placed on, or anchored in the ground or pavement.

Historic Signs. Signs which the Historic Preservation Commission has evaluated for historical significance, determined to be historically significant, and are listed on a Historic Sign Inventory on file in the Department of City Development. Historic Signs may include rooftop, projecting, freestanding, wall, obsolete, on-premises, off-premises, or nonconforming Signs.

Illegal. A Sign which is not authorized by this Ordinance, or was constructed or installed contrary to Ordinances existing on the date of construction or installation.

Incidental. A Sign, emblem, or decal, not exceeding one (1) square foot in area, informing the public of goods, facilities or services available on commercial premises; e.g., a credit card Sign or a Sign indicating hours of business.

CODE OF GENERAL ORDINANCES, 2021 - KENOSHA, WISCONSIN

Lot. Any parcel of land, the boundaries of which have been established by some legal instrument (subdivision, certified survey map, plat of survey, or deed), identifiable as a unit for the purpose of ownership or taxation.

Lot Line. The exterior line of any side of a premise, excluding public right-of-way.

Major Street. Streets as designated in Section 5.0 of the City of Kenosha Zoning Ordinance.

Monument. A Sign, mounted directly to the ground or pavement, with a maximum height not to exceed ten (10') feet and a total surface area not to exceed eighty (80) square feet per side.

Multiple Face. Two (2) or more identical Sign Faces which are placed back to back, or together, or are part of the same Sign structure, so that more than one (1) Sign Face cannot be readily viewed from any point at the same time.

Nameplate. A nonelectronic identification Sign, not exceeding one (1) square foot in area, mounted flush (having surface in same plane) to the principal building or displayed in a window, displaying the name of the business, owner, operator, or home occupation (i.e., John Jones, Realtor).

Nonconforming. A Sign that does not conform to the provisions, criteria and requirements of this Ordinance.

Obsolete. A Sign that remains erected and visible after the property has been vacant more than ninety (90) days.

Occupancy. The portion of a building used by an owner or operator for any lawful purpose, in compliance with the City Code of General and Zoning Ordinances.

Off-Premise Commercial Sign. A Sign identifying or advertising a business, owner, operator, product, service or commercial activity not located or available on the Premise where the Sign is located or directing persons to a different location from where the Sign is located.

On-Premise Commercial Sign. A Sign identifying or advertising a business, owner, operator, product, service or commercial activity located or available on the Premise where the Sign is located.

Ordinance. This Chapter.

Permanent. Any Sign attached to the ground, pavement or a building so as to be considered a fixture transferable upon sale of the Premise.

Person. Any individual, association, company, corporation, firm, organization, partnership or legal entity of any kind or nature.

Pole Banners. A Sign of fabric suspended from a pole by a crossbar within a business district or development which is artistic in character and conveys a noncommercial, nonproduct related theme.

Political. A Sign used in connection with a local, State or national election or referendum.

Portable/Temporary. A Sign, not permanently attached to the ground or pavement; or a Sign designed to be transported and used for display at various locations; or a moveable Sign on an A- or T-frame; or a menu or sandwich board Sign; or a balloon or an umbrella used as a Sign; or a Sign attached to or painted on a vehicle parked on or visible on the street right-of-way, unless said vehicle is used in the day-to-day operations of the business for purposes other than advertising or identification.

Premise. Any lot or group of contiguous lots which functions as one (1) unified development (i.e., strip malls, unified business center); and/or a group of land uses on a single lot; and/or a single lot, no matter how used.

Principal Building. The building in which is conducted the principal use of the Premise on which it is located. Storage buildings, garages, and other accessory buildings shall not be considered principal buildings.

CODE OF GENERAL ORDINANCES, 2021 - KENOSHA, WISCONSIN

Projecting. A Sign affixed to a building or wall in such a manner that its leading ledge extends more than fourteen (14") inches beyond the surface of such building or wall.

Real Estate. A Sign advertising all or a portion of the Premise upon which the Sign is located as being for sale, lease, or rent.

Recreation Area. Any land which is available to the public for recreational uses (i.e., sports, hiking, biking, swimming).

Residential Identification. Any Sign located in a district zoned for residential uses.

Right-of-Way. The area between lot lines reserved for vehicles and pedestrian travel, including the street surface, lawn park areas and sidewalks.

Roof. A Sign erected, constructed, or installed on and which extends over the roof of a building.

Setback. The distance from the lot line to the nearest part of the applicable building, Sign or Sign structure, measured perpendicularly to the lot line.

Sign. A device, fixture, placard, flag, or structure that uses any writing, representation, emblem, graphic, logo, symbol, or other display to advertise, or identify a business, owner, operator, product, service or commercial activity, or to communicate information of any kind.

Sign Clearance. The vertical distance measured from the bottom of the Sign to the grade below.

Sign Face. The extreme limits of the writing, representation, emblem, logo, graphic, symbol or other display together with any material or color forming an integral part of the background of the display or used to differentiate the Sign from the backdrop or structure against which it is placed.

Sign Structure. Any structure which supports or is capable of supporting a Sign as defined in this Ordinance. A Sign Structure may be a single pole and may or may not be an integral part of a building.

Special Announcement. A Sign located on residentially zoned property containing a personal announcement.

Street. A strip of land in a right-of-way subject to vehicular traffic providing direct or indirect access to property, including, but not limited to, streets, alleys, avenues, boulevards, courts, drives, highways, lanes, places, roads, terraces, trails and other public thoroughfares.

Street Frontage. The distance for which a street lot line of a premise abuts a street, from one lot line of premise intersecting said street to the furthest distant lot line of premise intersecting the same street.

Tethered Balloon(s). A bag made of material permeable to gas and filled with a type of gas lighter than ordinary air, designed to rise and float in the atmosphere, secured by a rope, chain, or similar means of attachment, so as to restrict its movement within a small radius.

Unified Business Center. A shopping center consisting of a group of permitted and/or conditional retail and/or commercial uses which are located in multiple buildings on a single lot or group of lots. The center is planned, developed and functions as a unit with common shared access, building materials and/or architectural features. A Unified Business Center is located on property zoned B-2. A Unified Business Center must be so designated by the Common Council.

Wall. A Sign attached parallel to, but within fourteen (14") inches of an outside wall of a building, or Sign painted on the surface of an outside wall or Sign erected and confined within the limits of an outside wall of a building.

Window. Any Sign that is placed inside a window or upon the window panes or glass and is intended to be visible from the exterior of the building.

CODE OF GENERAL ORDINANCES, 2021 - KENOSHA, WISCONSIN

15.03 PROHIBITION

A. It shall be unlawful for any person to erect, place, replace, move, establish, originally paint, construct, install, convert, substantially alter, rebuild, enlarge, remodel, relocate, illuminate, or maintain any Sign defined in this Ordinance in the City contrary to the applicable provisions, standards and requirements of this Ordinance.

B. Kenosha Water Utility Water Tower Signs Exempt. Signs placed or allowed on elevated water towers owned and maintained by the Kenosha Water Utility shall be exempt from the requirements and prohibitions proscribed in this Chapter.

15.04 PERMITTED AND PROHIBITED SIGNS

Signs shall be permitted or prohibited (not permitted) in the City in certain Zoning Districts in accordance with **Table 1**, attached hereto and incorporated herein. See Section 15.12 for Prohibited Signs.

15.05 SIGN NUMBER, AREA AND MEASUREMENT STANDARDS

A. Maximum Number of Signs and Maximum Area of Sign Faces. The total number and maximum area of Sign Faces shall not exceed the parameters contained in **Table 1**, except as provided below:

One additional Freestanding Sign (over the number designated in **Table 1**) may be permitted for a Premise which is located at the intersection of two major streets, and which Premise has a minimum of two hundred fifty (250) lineal feet of street frontage along both major streets.

On a Premise with multiple occupants, the Sign Face Area shall be determined in accordance with the requirements regulating a Unified Business Center, rather than **Table 1**.

Additional Freestanding Signs shall only be permitted if a special exception is granted by the Administrator due to circumstances uniquely related to the lot.

B. Calculation of Sign Face Area for Freestanding and Wall Signs. The area of a Sign Face for a Freestanding or Wall Sign shall be calculated by means of the smallest regular geometric shape (i.e., rectangle, circle or triangle), or combination thereof, that will encompass the Sign Face, but not including any supporting framework or wall when it is clearly incidental to the display itself.

C. Calculation of Sign Face Area for Monument Signs. The area of a Sign Face for a Monument Sign shall be calculated by including the Sign Face area around and enclosing the perimeter of the structure holding or supporting the Sign. The Sign base area shall be included in the calculation of the overall Sign Face area and Sign height. All elevations (i.e., berms) above the overall final grade of the Premise on which the Sign is located shall be included in the calculation of the overall Sign height.

D. Calculation of Sign Face Area for Multiple Faced Signs. The area of Sign Face for Multiple Faced Signs shall be calculated by adding together the area of the Sign Face(s) that can be read by one viewer at one time. Where two identical Sign Faces are placed back-to-back or on the same Sign support separated by less than four (4') feet, so that both faces cannot be read by any one viewer simultaneously, only one (1) of the faces shall be calculated for purposes of determining Sign Face area.

E. Calculation of Sign Height. The height of a Sign shall be calculated by determining the distance from the base of the Sign at normal grade in the vicinity of the Sign (excluding berms) to the top of the highest component of the Sign. Normal grade shall be construed to be the higher of the existing grade prior to construction, or the newly established grade after construction, exclusive of any filling, berming, molding, or excavating solely for the purpose of locating the Sign. Where the normal grade cannot reasonably be determined, Sign height shall be calculated on the basis that the elevation of the grade at the base of the Sign is equal to the elevation of the nearest point of the crown of a street or the grade of the land at the principal entrance to the Principal Building on the Premise, whichever is lower.

CODE OF GENERAL ORDINANCES, 2021 - KENOSHA, WISCONSIN

15.06 ADDITIONAL SIGN CRITERIA

The following Signs shall meet the additional criteria specified below:

A. Freestanding Sign. A Freestanding Sign located within fifteen (15') feet of any Lot line shall be limited to a maximum height of fifteen (15') feet, and a maximum total Sign Face area of forty-nine (49) square feet or a total Sign Face area equal to 50% of the Street Frontage, whichever is less.

Notwithstanding the above, all lots shall be entitled to a Sign having a minimum area of sixteen (16) square feet.

B. Monument Sign. A Monument Sign shall have a minimum five (5') feet setback from any Lot line and be outside of the visual clearance triangle.

C. Unified Business Center Sign. A Unified Business Center shall be permitted one Freestanding Unified Business Center Sign per Major Street Frontage. The Freestanding Unified Business Center Sign shall not exceed a total Sign Face area of one (1) square foot of Sign Face area per linear foot of Street Frontage, or three hundred fifty (350) square feet per side, whichever is less. A Unified Business Center Sign shall have a minimum fifteen (15) foot setback from any Lot line. No Freestanding Unified Business Center Sign shall exceed a height of thirty-five (35') feet. Signs within the Unified Business Center shall contain no more than two (2) sides.

An additional Freestanding Unified Business Center Sign is permitted in a Unified Business Center per four hundred (400') feet of Street Frontage, with a maximum of two (2) Signs permitted per Street Frontage.

Buildings on Outlots which are part of the Unified Business Center are permitted to have one (1) Freestanding Monument Sign not to exceed eighty (80) square feet of Sign Face area per side. No other freestanding Signs, except Exempt Signs, are permitted.

A special exception to setback requirements may be granted by the Administrator due to circumstances uniquely related to the lot.

D. Kenosha Industrial Park and Business Park of Kenosha. Signs within the boundaries of the Kenosha Industrial Park or Business Park of Kenosha shall adhere to the requirements of their respective protective covenants or this Ordinance, whichever is more restrictive.

E. Directional/Information Sign. A Directional/Information Sign shall not exceed eight (8) square feet in Sign Face Area and three (3') feet in height.

F. Canopy Installation and Construction Standards. Canopy installations which contain a Sign shall require a Sign Permit and be constructed in accordance with this Ordinance.

Fixed/Retractable Awnings shall be supported without posts by an iron bracket or by an iron framework attached firmly to the building. The frames and supports for all such Awnings shall be securely attached to the walls of the building upon which such Awning shall be placed and no such Awning shall project more than six (6') feet beyond the Lot line over any Street Right-Of-Way. The lowermost point of the frame of such Awning shall not be less than seven feet six inches (7'6") above the sidewalk and the lowermost part of the curtain scallop or valance shall be at least seven (7') feet above the Street Right-Of-Way when in use. The bracket or other device, frames and supports for the purpose used and the method of attachment to the building shall be such as to reasonably clear the heads of pedestrians at the building line, as determined by the Administrator.

G. Banner. A Sign Permit for each banner at a specified location on the principal building face, which does not exceed Sign area limitations in this Ordinance shall be required. Additional banners shall require additional permits.

H. Festoons. Festoons shall be replaced or removed when torn or faded.

CODE OF GENERAL ORDINANCES, 2021 - KENOSHA, WISCONSIN

I. Off-Premise Noncommercial Directional Signs. For the purpose of directing the public-at-large to noncommercial community-oriented facilities of general interest, permanent Off-Premise Directional Signs may be erected, in addition to Signs otherwise permitted in this Ordinance. The facility shall be open to the general public and operated by a noncommercial civic, charitable, religious, community, or similar organization of Internal Revenue Code 501(c)(3) status.

An Off-Premise Directional Sign may be installed on private property pursuant to the authorization of the Committee on Public Safety and Welfare. Off-Premise Noncommercial Directional Signs shall meet the following requirements:

1. The address of the property in question must be two (2) city blocks or farther from the nearest intersection.
2. Placement of the Sign shall be within one-half (1/2) mile or less from the entity.
3. A Directional Sign structure may be erected within fifty (50') feet of an intersection to direct traffic to locations otherwise not readily visible from the street.
4. The Sign and Sign structure shall not be permitted within vision clearance triangle areas.
5. The dimensions of a Directional Sign shall not exceed eight (8) square feet. The overall height of the Sign and Sign structure combined shall not exceed six (6') feet.
6. Each entity is allowed one (1) Noncommercial Directional Sign. One (1) Noncommercial Directional Sign is allowed per lot and/or premise.
7. The Sign shall be designed to be professional in appearance and shall meet all Building Codes and construction standards applicable to Sign design and construction.
8. Signs shall be permanent in nature and constructed of durable, weather-resistant materials and finish, including aluminum, steel and other similar materials. Cardboard, wood, paper, fabric, nonrigid materials and other similar materials are prohibited.
9. Signs must be securely weighted and stabilized so as not to shift in the wind or present public safety hazards. No moving parts shall be allowed on the Sign.
10. Sign materials, graphics and finish shall be of a unified design and shall be compatible and complementary to their surroundings in terms of shape, color, and texture. Lettering shall be legible and consistent.
11. Sign shall not be electric or illuminated.
12. No Sign shall be placed on private property without the written consent of the property owner on the permit application.
13. A Directional Sign shall provide only the names and/or logos of the subject entity or location in conjunction with directional information. The Sign shall be installed solely for the purpose of traffic direction and control, and not as an advertising medium. The entity name and/or logo shall not exceed fifty (50%) percent of the Sign area.
14. Qualified entities or locations wishing to be identified on a Directional Sign shall apply to the Administrator.
15. A Noncommercial Directional Sign may be erected on nonresidential properties, with the exception of multi-family lots.

15.07 SIGN PERMIT

A. Sign Permit Required. A Sign Permit from the Director of the Department of City Inspections shall be required for any Person to erect, place, replace, move, establish, originally paint, construct, install, convert, substantially alter, rebuild, enlarge, remodel, relocate, or illuminate any Sign upon private property,

CODE OF GENERAL ORDINANCES, 2021 - KENOSHA, WISCONSIN

whether a Permanent or Portable Sign, unless exempted from this requirement by this Ordinance.

B. Exemptions.

1. Noncommercial signs that are:
 - a. less than 16 square feet
 - b. not permanent
2. Table 1 of this Ordinance identifies Signs which require or do not require a permit.
3. The repair, routine maintenance or repainting of any existing Sign shall not be considered a substantial alteration or other activity requiring a permit hereunder.

C. Application. A Sign Permit for a Permanent or Portable Sign, except as otherwise provided in this Ordinance, shall not be granted or issued until after a fully completed application form has been filed with the Director of the Department of City Inspections by a licensed Sign erector showing the plans and specifications, dimensions, material, setback, elevation, projections, and details of the proposed Sign nor until all provisions of this Ordinance relating to such Sign shall be complied with, nor until after the payment of the prescribed fee for every such permit. The Director of the Department of City Inspections may prescribe the form of all applications for the various forms of permits herein required.

D. Fees. The Common Council shall, from time to time, establish the permit fees. Permit fees shall be waived for any permit under this Chapter applied for by the City of Kenosha, City of Kenosha Redevelopment Authority, Library, or Museum.

E. Portable Sign Permits. Portable Signs shall be permitted only upon the issuance of a Portable Sign Permit granted and issued by the Director of the Department of City Inspections subject to the following conditions and restrictions:

1. A Portable Sign Permit shall allow the use of a Portable Sign for a specified period of time, not to exceed thirty (30) consecutive days.
2. Only two (2) Portable Sign Permits shall be issued with respect to the same Premise in any calendar year.
3. All Portable Signs shall be anchored and supported in a manner which reasonably prevents the possibility of Signs becoming hazards to public health and safety. Any Portable Sign weighing in excess of fifty (50) pounds must conform to the requirements of the City Building Code.
4. Portable Signs shall not exceed thirty-two (32) square feet of Sign Face area per side.

15.08 SIGN ERECTOR'S LICENSE

A. Sign Erector's License Required. A license from the City Clerk shall be required for any person to engage in the business of contracting for or otherwise engaging in the erection, placement, replacement, movement, establishment, originally painting, construction, installation, conversion, substantial alteration, rebuilding, enlargement, remodeling, relocating, or maintenance of any On-Premise or Off-Premise Sign, with the exception of nonelectrical Monument Signs, Wall Signs, and Exempt Signs.

B. Application. No license shall be granted or issued by the City Clerk until application has been submitted upon a fully completed application form accompanied by required submittals. The City Clerk may prescribe the form of the application.

C. Fee. The license fee shall be Sixty (\$60.00) Dollars for the first license year and Thirty (\$30.00) Dollars for each renewal license year. License fees will not be prorated.

D. Term. Licenses shall expire on April 30th of each year.

E. Sign Erectors Bond. Every license applicant shall supply the City Clerk with the application, and

CODE OF GENERAL ORDINANCES, 2021 - KENOSHA, WISCONSIN

maintain during the license term a surety bond or other assurance approved by the City Attorney payable to the City in the penal sum of Ten Thousand (\$10,000) Dollars, which bond or assurance shall guarantee that all work is performed in accordance with this Ordinance and other applicable provisions of the Zoning and General Ordinances of the City and applicable laws, rules and regulations of the State of Wisconsin and Kenosha County. The bond or assurance shall be approved by the City Attorney.

F. Insurance. A condition of the issuance and maintenance of a license shall be the furnishing of a Certificate of Insurance, containing a provision that the City Clerk must be notified twenty (20) days in advance of the effective date of any modification, termination, nonrenewal, or cancellation thereof, which Certificate shall indicate that there is, in full force and effect, a policy of public liability insurance and motor vehicle liability insurance for each motor vehicle used in conjunction with the licensed activity, issued by an insurance company licensed to do business in the State of Wisconsin, in the minimum amount of Three Hundred Thousand (\$300,000) Dollars, single limits, protecting against claims involving death, personal injury and property damage.

G. Sign Erectors Responsibility for Code Violations. Whenever a Sign Erector performs work in the City and said work is performed contrary to the terms of this Ordinance, said Sign Erector must conform said work to comply with this Ordinance within the time directed, in writing, by the Director of the Department of City Inspections, and the failure of the Sign Erector to timely conform said work to this Ordinance shall be a violation of this Ordinance, subject to both the penalty provisions of this Ordinance and a claim against the Surety Bond or other assurance filed with the City.

15.09 NONCONFORMING, ABANDONED AND OBSOLETE SIGNS

Except as otherwise provided herein, the owner or operator of any Premise upon which exists a Nonconforming and/or Abandoned Sign shall remove such Sign in accordance with written notice from the Administrator.

Where a Premise is vacated for a period of ninety (90) or more consecutive days, all Nonconforming, Abandoned and Obsolete Signs shall be either removed from the Premise or made to conform with this Ordinance.

Nonconforming, Abandoned and Obsolete Signs shall not be used to advertise that the premise upon which the Sign is situated is "For Sale".

Signs determined to be historically significant by the Historic Preservation Commission and are included on a Historic Sign Inventory may be nonconforming only as to height, setback, and Sign face area.

A Sign that lawfully existed on the effective date of this Ordinance, and which does not conform to the provisions, criteria and requirements of this Ordinance; and/or, a Sign which does not conform to the requirements of this Ordinance, but for which a permit has been issued and is in full force and effect (i.e., Billboard), may remain nonconforming only as to height, setback and Sign Face area, provided it is not vacated for a period of ninety (90) or more consecutive days.

15.10 SIGNS IN STREET RIGHT-OF-WAY

No Sign shall be placed upon any Street Right-of-Way except for the following:

A. Signs erected by or on behalf of the City of Kenosha to post legal notices, identify streets and public property, convey public information and direct or regulate pedestrian and/or vehicular traffic.

B. Signs approved by the City Traffic Engineer (i.e., Neighborhood Crime Watch Signs).

C. Banners, Signs, Decorations and Obstructions permitted under and in compliance with Section 5.045 of the Code of General Ordinances.

D. Signs authorized by a Street Encroachment Agreement approved by the Common Council.

E. Subdivision Entrance Signs which are authorized in an approved Subdivision Agreement.

CODE OF GENERAL ORDINANCES, 2021 - KENOSHA, WISCONSIN

F. Signs authorized by an Outdoor Dining Area Permit and in compliance with Section 5.046 of the Code of General Ordinances.

15.101 SIGNS ON ABOVEGROUND UTILITY STRUCTURES IN OR ADJACENT TO THE PUBLIC RIGHT-OF-WAY

A. Prohibition. It shall be unlawful for any person to erect, place, replace, install, establish, alter, or maintain any Sign on a aboveground utility structure that is located in the public right-of-way, or has any portion of said aboveground utility structure within ten (10') feet of a public right-of-way. "Aboveground Utility Structure" means any structure, cabinet, electric meter or other appurtenance, owned or used by a utility company, a telecommunications provider, a video service provider or utility regulated by the Public Service Commission of the State of Wisconsin, that extends upon the ground upon which it is built. This definition does not include traffic control devices or infrastructure that provides water for fire suppression. This definition also does not include a pole or a device attached to a pole if the lowest portion of the device is maintained at a height of at least ten (10') feet above the ground.

B. Exemptions. The prohibition of Section 15.101 A. shall not apply to the following:

1. A warning label, the sole purpose of which is to notify the public of special hazards; or,
2. Identifying information for the installation if the following apply:
 - a. The identifying information is placed on the face of the Aboveground Utility Structure's most remote from the street, running along the front of the lot in which the Aboveground Utility Structure is located;
 - b. The typeface of the identifying information is no greater than 16 point; and,
 - c. Any background color to the information matches as closely as practicable to the color of the Aboveground Utility Structure adjacent to the place of the information.

15.11 EXEMPT SIGNS

The following Signs shall be exempt from the requirement of this Ordinance to obtain a Sign Permit, but shall be subject to and be in compliance with the Code of General Ordinances and Zoning Ordinance, the other conditions and requirements of this Ordinance, and the specific conditions and restrictions below provided.

Address Numerals. Address numerals as defined in Section 9.18 C. of the City of Kenosha Code of General Ordinances.

Architectural Elements. Architectural elements of a building which include an integral and incidental Sign, so long as such elements do not contain a commercial message, moving parts, or lights.

Building Marker. A Building Marker not to exceed a Sign Face of four (4) square feet.

Bulletin Board. One (1) Bulletin Board located at main entrance of building, not exceed a Sign Face of twelve (12) square feet (i.e., list of occupants, hours of operation, or special events).

Construction Signs. One (1) construction Sign per Street Frontage, when placed on the Premise where work is in progress. Such Signs shall not be erected prior to the beginning of work for which a valid Building or Demolition Permit has been issued, and shall be removed within ten (10) days of completion of work or the expiration of the permit, whichever is sooner. Construction Sign Faces for single-family residences shall not exceed sixteen (16) square feet. Construction Sign Faces for commercial, industrial, multifamily or planned development uses on parcels of less than 100,000 square feet shall not exceed sixty-four (64) square feet; and on parcels greater than 100,000 square feet shall not exceed ninety-six (96) square feet.

Digital Display Off-Premises Sign. An off-premises advertising sign, display or device that may contain multiple or variable messages, including messages on louvers that are rotated and messages formed solely by use of lights or other electronic or digital displays, that may be changed by any electronic process.

CODE OF GENERAL ORDINANCES, 2021 - KENOSHA, WISCONSIN

Directional/Informational Signs. A Sign that has a purpose secondary to the use of the lot on which it is located, such as "No Parking", "Entrance", "Loading Only", "Telephone", "Enter", and other similar directives. No Sign with a commercial message, legible from a position off the lot on which the Sign is located, shall be considered directional/informational. There shall be no limitation on the number of such Signs per premise provided all such Signs are directional or informational in nature.

Elevated Water Towers. Signs placed or allowed on elevated water towers owned and maintained by the Kenosha Water Utility.

Flags, Standards, Emblems and Insignia. Flags, standards, emblems, and insignia of public and not-for-profit institutions.

Governmental Signs. Signs erected by or on behalf of a Federal, State or local governmental unit for a public purpose, meeting area, height and setback limitations of this Ordinance, where applicable.

Historic Signs. Signs which the Historic Preservation Commission has evaluated for historical significance, determined to be historically significant, and are listed on a Historic Sign Inventory on file in the Department of City Development. These Signs may be maintained and preserved without a Sign Permit. Changes to the Sign or message on the Sign (where the message is of historical significance) require a Sign Permit. Historic Signs may include rooftop, projecting, freestanding, wall, obsolete, on-premises, off-premises, or nonconforming Signs.

Historical Markers. Commemorative plaques, memorial tablets or emblems of official historical bodies, not exceeding four (4) square feet placed flat against a building, monument stone, or other permanent surface.

Holiday Decorations. Holiday Decorations as a temporary display, clearly incidental to and customarily associated with holidays designated by any unit of government, limited in duration to the respective holiday season generally recognized by the Kenosha business community.

Incidental Signs. A small Sign, emblem or decal, not exceeding one (1) square foot in area, informing the public of goods, facilities or services available on commercial premises; e.g., a credit card Sign or a Sign indicating hours of business.

Interior Signs. Interior Signs which provide information, but not a Commercial Message, not exceeding a total of four (4) square feet of Sign Face per Premise located on the interior of a Premise, oriented to persons within that Premise, and not intended to be legible from any location Off-Premise.

Model Home Signs. Model Home Signs not to exceed a Sign Face of eight (8) square feet identifying a non-occupied dwelling unit used as a demonstration unit for selling, leasing, or renting other dwelling units.

Nameplates. One flush mounted, nonilluminated nameplate, provided that only one (1) nameplate per occupancy may be erected and that such nameplate shall not exceed one (1) square feet.

Notices. Notices posted by Federal, State, or local units of government.

Parks. Commercial signs placed in city-owned parks or recreational areas provided such sign received approval by the Parks Commission, such approval being subject to annual review.

Political Campaign Signs. Signs promoting candidates for public office or issues on election ballots, not exceeding thirty-two (32) square feet per occupancy, posted on private property in accordance with this Chapter.

Real Estate Signs. One (1) Real Estate Sign per Street Frontage of a Lot or Premise, not to be directly illuminated and not to exceed a Sign Face of eight (8) square feet for residential districts, thirty-two (32) square feet for commercial districts, or sixty-four (64) square feet for industrial districts.

Religious Institution Signs. Bulletin boards, Identification and Directional Signs pertaining to religious institutions, not exceeding one (1) per abutting street, nor sixteen (16) square feet, which are not internally

CODE OF GENERAL ORDINANCES, 2021 - KENOSHA, WISCONSIN

Illuminated.

Special Announcement Signs. Special Announcement Signs not to exceed Sign Face of thirty-two (32') square feet, where not located on the same Lot or Premise for more than three (3) consecutive days per occasion.

Special Displays. Special displays used for public celebrations, on public property, by or approved by City.

Signs in Street Right-of-Way authorized by this Ordinance.

15.12 PROHIBITED SIGNS

All Signs not expressly permitted are prohibited in any location in the City. The following Signs are specifically prohibited:

1. Signs containing statements, words or pictures of an obscene or pornographic nature.
2. A Sign, handbill, notice or poster affixed to a tree, fence, pole, Street Sign, Traffic Sign or other structure not constructed or intended for use as a Sign base, which is not authorized by this Ordinance.
3. Revolving Signs.
4. Roof Signs.
5. Signs which are structurally dangerous, or unsafe.
6. Abandoned/Obsolete Signs.
7. Flashing and Animated Signs.
8. Deteriorated Signs.
9. Signs used beyond time limits provided in this Ordinance.

15.13 POWER AND AUTHORITY FOR REMOVAL OF NONCONFORMING AND/OR PROHIBITED SIGNS AND SIGN STRUCTURES

The Administrator shall have the power and authority to remove or cause to be removed any and all Nonconforming, Abandoned, Obsolete and/or prohibited Signs and Sign Structures.

If upon inspection, the Administrator finds that a Sign or Sign Structure is Nonconforming, Abandoned, Obsolete, and/or prohibited, the Administrator shall issue a written order to the owner or operator of the Premises upon which the Sign or Sign Structure is located stating the nature of the violation and requiring them to repair, remove, or conform the permanent Sign or Sign Structure within thirty (30) days of the date of the order and remove temporary Signs or Sign Structures within five (5) days of the order.

When it becomes necessary for the Administrator to remove or cause to be removed, or take down, a Nonconforming, Abandoned, Obsolete, defective, unsafe or dangerous Sign or Sign Structure, the cost thereof shall be placed on the tax roll as a special assessment and become a lien against the benefitted property, unless paid sooner.

Prohibited Signs or Sign Structures in a street right-of-way or on public property may be removed and destroyed by the Administrator or Police Department, without notice.

15.14 POLITICAL SIGNS

Political Signs may be displayed in front, side and rear yards, (as those terms are defined in the Zoning Ordinance), on a Premise in any Zoning District only during the following times: Commencing with the filing of nomination papers of the candidate for public office with the appropriate governmental office in charge thereof or the placement of an issue on an election ballot and terminating seven (7) days after the election for the

CODE OF GENERAL ORDINANCES, 2021 - KENOSHA, WISCONSIN

position or issue which is the subject of the referendum.

15.15 OFF-PREMISE SIGNS

A. Purpose. This Section is intended to protect the public health, safety and welfare by regulating the construction, materials, placement/location, size, height, spacing and maintenance of Off-Premise Commercial Signs. This Section is designed to ensure that Off-Premise Commercial Signs are compatible with other Signs and land uses, and are not detrimental to the aesthetic quality of the community.

Off premise commercial signs are subject to City approval pursuant to the following procedures:

1. Sign Replacement (same size sign in the same location): off premise sign permit.

2. New Sign Location or Relocation where the Proposed Sign is 300 Square Feet or Less: site plan review in conformance with Section 14.0 of the Zoning Ordinance.

3. New Sign Location or Relocation where the Proposed Sign is Greater than 300 Square Feet: site plan review in conformance with Section 14.0 of the Zoning Ordinance.

4. Bulletin Sign (Size 14' x 48'): site plan review in conformance with Section 14.0 of the Zoning Ordinance.

5. Sign Not in Compliance with §15.15 H.5 and §15.15 H.7: conditional use permit in conformance with Section 4.0 of the Zoning Ordinance.

6. Digital Display: conditional use permit in conformance with Section 4.0 of the Zoning Ordinance.

All Off-Premise Commercial Signs existing in the City shall be maintained in accordance with the following conditions and restrictions.

B. Illumination.

1. The light rays from any Off-Premise Commercial Sign which is externally illuminated shall be cast directly upon the Sign Face surface and shall not be visible to motor vehicle operators, except as may be reflected from the Sign Face. The illumination of Off-Premise Commercial Signs will not be permitted between 12:00 A.M. and 5:00 A.M. No Off-Premise Commercial Sign shall contain flashing elements or video displays.

2. Digital Display Illumination. Digital Display Off-Premise Signs shall be subject to the following regulations:

a. Each change of message shall be accomplished in one second or less.

b. Each message shall remain in a fixed position for at least 6 seconds.

c. The use of traveling messages or segmented messages is prohibited.

d. No variable message sign lamp may be illuminated to a degree of brightness that is greater than necessary for adequate visibility. Signs found to be brighter than necessary for adequate visibility shall be adjusted by the person owning or controlling the sign in accordance with the instructions of the Common Council.

e. The Common Council by rule, may prohibit or establish restrictions on the illumination of messages to a degree of brightness that is greater than necessary for adequate visibility.

f. The illumination of Off-Premise Commercial Signs with Digital Display Illumination has no restriction of hours of operation.

C. Wind Load Requirement. Off-Premise Commercial Signs shall be maintained so as to withstand a wind load/pressure of not less than thirty (30) pounds to the square foot.

D. Nonconforming Off-Premise Commercial Signs. Any existing Off-Premise Commercial Sign

CODE OF GENERAL ORDINANCES, 2021 - KENOSHA, WISCONSIN

constructed, erected and installed in accordance with applicable State and local laws, rules and regulations established on the effective date of this Ordinance and which Sign becomes Nonconforming by the provisions herein, shall be a Nonconforming use and any Sign which, as a result of subsequent amendments hereto becomes Nonconforming, shall also be a Nonconforming use and is to be subject to Section 7.0 of the Zoning Ordinance.

No Nonconforming Off-Premise Commercial Sign structure shall be altered or reconstructed, unless the alteration or reconstruction is in compliance with the provisions of Section 7.0 of the Zoning Ordinance. For the purpose of this Section only, the term "altered or reconstructed" shall not include painting, rustproofing, changing of advertising message or the installation of cable and bracket components necessary to ratchetably anchor a flex billboard of the type having a fully recyclable polyethylene substrate. For inspection purposes, an approved building permit must be obtained prior to the commencement of any work associated with the installation of cable and bracket components.

Nonconforming Off-Premise Commercial Signs may continue in use only when in compliance with the following:

1. The Sign must have been actually in existence as of the effective date of this Ordinance.
2. The Sign may be sold, leased, or otherwise transferred without affecting its Nonconforming status, but its location may not be changed. An off-premise commercial sign removed as a result of a street Right-of-Way taking or for any other reason may be relocated.
3. The Sign must have been constructed, erected, and installed in accordance with applicable State and local laws, rules and regulations that were in effect at the time this Ordinance was enacted, and must continue to be maintained in accordance with this Ordinance. Failure to adhere to rules and regulations associated with construction, erection and installation of Off-Premise Signs, including failure to obtain permit approvals, shall render the Sign illegal.
4. In accordance with Section 62.23(7)(h), Wisconsin Statutes, Signs which are a nonconforming use must remain the same as they were on the effective date of this Ordinance and may not be enlarged or expanded. Any extension, enlargement, rebuilding, changing the materials of the Sign structure, changing the size of the Sign structure materials, adding catwalks, adding guys or struts for stabilization of the Sign or structure, adding lights to a nonilluminated Sign, changing the height of the Sign aboveground, structural alteration to prolong the life of the sign or re-erection of the Sign shall not during the sign's life exceed 50 percent of the assessed value of the sign unless permanently changed to a conforming use.
5. The Sign may continue in use as long as it is not abandoned or discontinued. A Sign is deemed destroyed when it is rendered any or all of the following descriptions: dismantled, removed or modified from its original state. A Sign is deemed abandoned or discontinued if for a period of twelve (12) months or longer, it is composed of obsolete advertising matter, or is without advertising matter, or is in need of substantial repair provided that any period of involuntary discontinuance which occurs during the period a street is closed shall not be considered. A Sign is deemed abandoned or discontinued if the name of the owner does not appear thereon and if the name and address of the current owner is not readily ascertainable from records on file with the Department of City Development.

An unsafe to abandoned Sign is declared a public nuisance, which shall be abated by the owner within sixty (60) days of receiving notice from the Department. After sixty (60) days, the Sign may be removed by the Department, and the cost thereof shall be placed on the tax roll as a special assessment and become a lien against the benefited property, unless paid sooner.

E. Identification of Sign Erector. On every Off-Premise Sign erected, the erector shall, in a permanent manner, state the name and address of the Sign erector that erected the Sign, the permit number, and the date of its erection. Such information must be readable from a distance of at least one (1) foot.

CODE OF GENERAL ORDINANCES, 2021 - KENOSHA, WISCONSIN

F. Off-Premise Sign License.

1. **License Required.** An annual Off-Premise Sign License for each Off-Premise Sign Face.

2. **Fees.** The fee for such License shall be calculated for each Sign Face. License fees are not proratable. License fees shall be deposited in a special revenue fund, which shall be used to offset the City's cost associated with the annual inspection and licensing of each Sign Face. The Common Council shall, from time to time, establish the License Fees.

3. **Term.** Every License issued hereunder shall expire on the first (1st) day of July of the year following the date of issuance.

G. Replacement Sign Credit. The owner of an existing Off-Premise Sign may receive a Replacement Sign Credit upon removal of an existing Off-Premise Sign. The owners or operators of Off-Premise Signs which are ordered to be removed by the Administrator to protect the public's welfare and safety, or Signs which are damaged or destroyed beyond twenty-five (25%) percent of its then current value, may also receive a Replacement Sign Credit.

The Replacement Sign Credit shall be subject to the following conditions:

1. The Replacement Sign Credit shall not expire.

2. Replacement Sign Credits are transferable.

3. The holder of the Replacement Sign Credit shall locate and construct, install and erect an Off-Premise Sign in accordance with this Ordinance as it exists at the time of construction, erection and installation.

4. A Replacement Sign Credit shall be awarded for each sign face removed.

H. Replacement Sign Credits. Off-Premise Signs constructed as a result of Replacement Sign Credits shall be subject to the following Ordinance standards.

1. **Permitted Zoning Districts.** Off-Premise Signs are permitted only in the B-2, M-1, M-2 Zoning Districts and are subject to the regulations of those districts.

2. **Size Requirements.** Off-Premise Signs shall not exceed six hundred seventy-two (672) square feet of Sign Face area per Sign Face, not including any trim, supporting frame work, uprights or decorative fencing/apron, for a total Sign Face area of one thousand three hundred forty-four (1,344) square feet to include both sides and faces. The Sign Face area per Sign Face shall be calculated on the basis of adding together the area of the Off-Premise Sign Face(s) that can be read from one (1) direction at one (1) time. Where two identical Off-Premise Signs are placed back-to-back on the same Sign supports, the Signs shall not be separated by more than four (4') feet so that both Sign Faces cannot be read from one direction simultaneously. A Sign extension comprising no more than ten (10%) percent of the allowable Sign Face area may be added providing the extension does not extend more than five (5') feet beyond the perimeter of the Sign Face.

3. **Setback Requirements.** Off-Premise Signs shall be set back fifteen (15') from the Street Right-Of-Way and shall be located so as to avoid any contact with communication and/or electrical lines. The distance will be measured from the area of the Sign structure closest to the Street Right-Of-Way. Off-Premise Signs shall also comply with setback and other requirements of State law when located abutting Federal or State highways, or interchanges.

4. **Spacing Between Off-Premise Signs.** Off-Premise Signs shall comply with the spacing requirements of State laws, rules, and regulations, and in no case shall Off-Premise Signs be permitted to be constructed, erected or installed within five hundred (500) feet of another Off-Premise Sign on the same side of the street.

5. **Height.** The maximum height to the top of any Off-Premise Sign shall be thirty-five (35') feet. The height of a such Sign shall be computed as the distance from the base of the Sign at normal grade to the top

CODE OF GENERAL ORDINANCES, 2021 - KENOSHA, WISCONSIN

of the highest attached component of the Sign. Normal grade shall be construed to be the higher of: the existing grade prior to construction; or the newly established grade after construction exclusive of any filling, berming or excavating solely for the purpose of locating the Sign. In cases in which the normal grade cannot reasonably be determined, height shall be computed on the assumption that the elevation of the normal grade at the base of the Sign is equal to the elevation of the nearest point of the crown of a public street. Off-Premise Signs located on a premise adjacent to frontage roads, on interstates, expressways, or State highways where pavement grade may be higher due to bridges entrance/exit ramps may be allowed to achieve a maximum height of thirty-five (35') feet above the highest point of that pavement grade. Signs within one thousand (1,000') feet of the Interstate Highway Right-of-Way shall have a maximum height of forty (40') feet above the center line of the roadway from which it is intended to be viewed, or grade at the sign structure, whichever is greater. If adjacent to an Interstate Highway bridge or viaduct shall have a maximum height of fifty (50') feet above the center line of the roadway from which it is intended to be viewed or grade at the sign structure, whichever is greater.

6. Off-Premise Signs are prohibited in any Historic District, on any bridge crossing, and shall not be located on or over the roof of a building.

7. Off-Premise Signs shall not be constructed, erected or installed within seventy-five (75') feet of the B-3 Central Business District.

Off-Premise Signs shall not be constructed, erected or installed one hundred fifty (150') feet of any Residential or IP Institutional Park District. This restriction shall not be applicable to any Residential or IP Institutional Park District Zoned property located on State Highways.

Off-Premise Signs shall not be constructed, erected or installed within two hundred (200') feet of any Historic Site or Historic District, or any school, church, public park, Recreation Area or public playground. This distance shall be measured from the outermost portion of the Off-Premise Sign structure.

8. No Off-Premise Sign shall be erected in a location prohibited by this Ordinance.

9. No Off-Premise Sign shall be erected so as to prevent ingress or egress from any door or window, or any other exitway required by the Building or Fire Codes of the City.

10. No Off-Premise Sign shall be located in such a manner as to obscure, or otherwise interfere with the effectiveness of a traffic Sign, signal or device, obstruct or physically interfere with a motor vehicle operator's view of approaching, merging or intersecting traffic.

11. No Off-Premise Sign shall be attached to a standpipe, gutter drain or fire escape.

12. No Off-Premise Sign shall be erected so to impair access to a roof.

I. Off-Premises Signs in City Parks or Recreation Areas. This section does not apply to off-premise signs placed in City parks or recreational areas pursuant to authorization for non-permanent placement, from the Parks Commission.

J. Off-Premise Sign Cap. The number of Off-Premise Signs in the City is limited to 105 signs, which is the number of such Signs in existence on the 1st day of October 2011, notwithstanding the addition of any existing signs as the result of annexation or attachment. The installation of an Off-Premise Sign is permitted only with Replacement Sign Credits.

15.16 CONSTRUCTION AND MAINTENANCE

The construction, erection, installation, anchorage, wiring and maintenance of all Signs shall be subject to the City Building Code, where applicable.

No Sign shall be constructed, erected, installed or maintained in a dangerous or unsafe condition or in a condition of substantial disrepair.

Overhead wiring to or from the Sign, of any type, is prohibited. No electrical connections may be made

CODE OF GENERAL ORDINANCES, 2021 - KENOSHA, WISCONSIN

from any Sign to an electrical service, or from an electrical service to any Sign, except by a licensed electrician, and in conformance with the City Building Code. Electrical systems for Signs shall be properly permitted through the Department of City Inspections and wired in according with Building Code standards.

All Signs, together with all of their supports, braces, guys and anchors, shall be of rust-inhibitive material or treatment and shall be maintained in a good and serviceable condition. The display surfaces of all Signs shall be kept in a condition that will not contribute to blight.

15.161 REINSPECTION FEES

To compensate the City for inspection and administrative costs related to the enforcement of this Chapter, a fee of Sixty (\$60.00) Dollars may be charged for any reinspection following the initial inspection which resulted in an order for corrective action and the first reinspection to determine compliance with an order for corrective action issued hereunder. There shall be no reinspection fee for a final inspection indicating compliance or for a reinspection occurring during the period of an approved time extension granted for good cause and involving a "good faith" effort on the part of the property owner to comply with the order. A fee of Ninety (\$90.00) Dollars may be charged for a second reinspection; a fee of One Hundred Eighty (\$180.00) Dollars may be charged for a third reinspection; and, a fee of Three Hundred Sixty (\$360.00) Dollars may be charged for each subsequent reinspection. Reinspection fees which are not paid by or on behalf of the property owner within thirty (30) days of mailing of an invoice to the property owner of record on the City tax roll shall be charged and collected as a special assessment against the real estate upon which the reinspections were made, and shall be lien upon the real estate until paid in full, with interest accruing on the unpaid balance at the rate of seven (7%) percent per annum. There shall also be a One Hundred (\$100.00) Dollar administrative charge added to the charge and special assessment to cover the administrative costs of charging and specially assessing the property.

15.162 RECURRING VIOLATION

As used herein, "recurring violation" shall mean a second, or any subsequent violation of any provision of this Chapter 15 committed by a person within any one (1) year period and for which the person admits responsibility or is determined to be the responsible person.

Whenever a notice of violation and order has been issued to the responsible person or tenant, where relevant, for a violation of this Code, no further notice and order shall be necessary for any recurrence of the same or similar violation prior to the commencement of any forfeiture action or prior to seeking an injunction in a court of record.

15.17 APPEALS AND SPECIAL EXCEPTIONS

A. Administration. It shall be the duty of the Administrator to administer and enforce this Ordinance.

B. Special Exceptions. Upon application for a Special Exception, the City Plan Commission may, after investigation and public hearing, grant a Special Exception from the terms of this Ordinance where such Special Exception will not be contrary to the spirit and purpose of this Ordinance, and where a Special Exception will do substantial justice.

Applications for Special Exceptions may be made for any Section of this Ordinance except for the location of Off-Premises Signs within specific zoning districts.

C. Appeals.

1. Appeal of a Decision of the Administrator. An aggrieved person adversely affected by the denial of a permit or decision, determination or interpretation by the Administrator may appeal such denial, decision, determination or interpretation to the City Plan Commission.

2. Appeal of a Decision of the City Plan Commission with Regard to a Special Exception. An aggrieved person adversely affected by the denial of a Special Exception by the City Plan Commission for

CODE OF GENERAL ORDINANCES, 2021 - KENOSHA, WISCONSIN

which application was made pursuant to Subsection B, may appeal the denial to the Common Council.

3. Appeal. Appeals must be filed with the Department of City Development within thirty (30) days of the decision being appealed, and must include the payment of the fee therefor established by the Common Council, from time to time by resolution.

D. Application Procedure. Any application for a Special Exception or appeal shall be taken pursuant to this Ordinance.

15.18 PENALTY

Any Person who shall violate or cause to be violated any provisions of this Ordinance, shall upon conviction thereof, be fined not less than Fifty (\$50.00) Dollars nor more than Five Hundred (\$500.00) Dollars, together with the costs of prosecution, and in default of timely payment thereof, shall be committed to the Kenosha County Jail for a term not exceeding ninety (90) days. Each day a violation exists, or continues, shall constitute a separate offense.

CODE OF GENERAL ORDINANCES, 2021 - KENOSHA, WISCONSIN

TABLE 1

SIGN DESCRIPTIONS	ZONING DISTRICTS					
	B-1B-2/B-3	IP	M-1/M-2	RQ/RS/RD/RR	RM	
Banners* [Mounted flush to principal building only - see Ordinance requirements]	PERMITTED	PERMITTED	PERMITTED	NOT PERMITTED	NOT PERMITTED	
Canopy Structures* [Not to exceed 15% per side of each canopy face.]	PERMITTED	PERMITTED	PERMITTED	NOT PERMITTED	NOT PERMITTED	
Construction: One (1) Sign per street frontage. Parcels 100,000 s.f. or less: 64 s.f. maximum Sign area. Parcels 100,000+: 96 s.f. maximum Sign area.	PERMITTED Refer To Previous Criteria	PERMITTED Refer to Previous Criteria	PERMITTED Refer to Previous Criteria	Single Family: Not to exceed Sixteen (16) square feet PERMITTED	Multi-family: Refer To Previous Criteria PERMITTED	
Directional/Information* [8 s.f. Sign area/3 foot height max.]	PERMITTED	PERMITTED	PERMITTED	PERMITTED	PERMITTED	
Freestanding* [Pylon/ground] - individual parcels - one (1) Sign per lot. Sign setback: fifteen (15) feet	PERMITTED B-1: 25' Max. Ht. B-2: 35' Max. Ht. B-3: 25' Max. Ht.	NOT PERMITTED	PERMITTED Max. Height 35'	NOT PERMITTED	NOT PERMITTED	
- Freestanding signs which are located less than 15' from the lot line are limited to a maximum height of 15' and a total sign area of 49 s.f. or 50% of street frontage whichever is less. No more than two (2) sides permitted.	- Not Permitted Within Unified Business Districts		-Not Permitted Within Unified Business Districts			
- Maximum Sign Area: B-1/B-3/P: 100 s.f. or 1 s.f. per lineal lot street frontage, whichever is lowest.						
- B-2/M-1/M-2: 150 s.f. or 1 s.f. per lineal lot street frontage, whichever is lowest.						
Ground Sign* Residential Identification [32 s.f. area/5' height maximum]	PERMITTED	PERMITTED	PERMITTED	PERMITTED	PERMITTED	
Marquee* One (1) per building/ 12' above circulation lane.	PERMITTED	PERMITTED	NOT PERMITTED	NOT PERMITTED	NOT PERMITTED	
Monument* [80 s.f. base inclusive - 10' height maximum]	PERMITTED	PERMITTED	PERMITTED	NOT PERMITTED	NOT PERMITTED	
Name Plates [Not to exceed one (1) s.f. - wall sign only]	PERMITTED	PERMITTED	PERMITTED	PERMITTED	PERMITTED	
Off-Premise Commercial Signs [Refer to Section 15.15]	NOT PERMITTED	NOT PERMITTED	NOT PERMITTED	NOT PERMITTED	NOT PERMITTED	
Portable/Temporary* [30 day limit/ two (2) times per year 32 s.f. maximum, except inflatable figures]	PERMITTED	PERMITTED	PERMITTED	PERMITTED	PERMITTED	
Projecting* One (1) per occupancy/ 12' above circulation lane.	PERMITTED	PERMITTED	PERMITTED	NOT PERMITTED	NOT PERMITTED	

CODE OF GENERAL ORDINANCES, 2020 - KENOSHA, WISCONSIN

Sign Descriptions - Continued	ZONING DISTRICTS					
	B-1/B-2/B-3	IP	M-1/M-2	RG/RS/RD/RR	RM	
Real Estate: One (1) Sign per street frontage of lot.	Not To Exceed 32 Square Feet	Not To Exceed 8 Square Feet	Not To Exceed 64 Square Feet	Not To Exceed 8 Square Feet	Not To Exceed 32 Square Feet	
Residential/Accessory: [i.e., private parking, trespass]	Not To Exceed 4 Square Feet	Not To Exceed 4 Square Feet	Not To Exceed 4 Square Feet	Not To Exceed 4 Square Feet	Not To Exceed 4 Square Feet	
Residential Identification* [32 s.f. area/ 5' height maximum]	PERMITTED	PERMITTED	PERMITTED	PERMITTED	PERMITTED	
Roof	NOT PERMITTED	NOT PERMITTED	NOT PERMITTED	NOT PERMITTED	NOT PERMITTED	
Special Announcement	NOT PERMITTED	NOT PERMITTED	NOT PERMITTED	PERMITTED	PERMITTED	
Unified Business Center* - One (1) major street frontage, as defined within the Sign Ordinance. All outlots shall be permitted one (1) Monument Sign only.	PERMITTED IN B-2 ONLY: 1 square foot lineal foot or 350 square foot, whichever is less - two (2) sides maximum/ Maximum Height: 35/ Setback: 15'	NOT PERMITTED	NOT PERMITTED	NOT PERMITTED	NOT PERMITTED	
Wall* [15% of total wall area - principal building only]	PERMITTED	PERMITTED	PERMITTED	PERMITTED IN RD/RR	NOT PERMITTED	
Window	PERMITTED	PERMITTED	PERMITTED	NOT PERMITTED	NOT PERMITTED	

*Denotes that a Sign Permit is Required.

CODE OF GENERAL ORDINANCES, 2021 - KENOSHA, WISCONSIN

CHAPTER XVI PROPERTY MAINTENANCE CODE

- 16.01 Title
- 16.02 Definitions
- 16.03 General
- 16.04 Applicability
- 16.05 Code Official
- 16.06 Powers and Duties of The Code Officials
- 16.07 Approval of Alternative Materials, Methods and Equipment
- 16.08 Violations
- 16.09 Notices And Orders
- 16.10 Unsafe, Unfit For Occupancy, Unlawfully Occupied, Vacant Substandard Structures And Unsafe Equipment
- 16.101 Standards For Securing Structures
- 16.11 Emergency Measures
- 16.12 Razing Structures
- 16.13 Board of Housing Appeals
- 16.14 Lodging Houses
- 16.141 Prohibition of Residential Tenancies of Less Than Seven Days
- 16.15 Rent Withholding
- 16.151 Chronic Nuisance Property
- 16.16 General Property Maintenance Requirements
- 16.17 Exterior Premises
- 16.18 Exterior of Structures
- 16.19 Interior of Residential Units
- 16.20 Waste Collection and Removal and Recycling
- 16.21 Infestation and Extermination
- 16.22 Light, Ventilation and Occupancy Limitations
- 16.23 Plumbing Systems Facilities and Fixture Requirements
- 16.24 Mechanical and Electrical Facilities and Equipment
- 16.25 Fire Safety Requirements
- 16.251 Reinspection Fees
- 16.26 Penalties

16.01 TITLE

This Chapter of the Code of General Ordinances shall be known as "Property Maintenance Code of the City of Kenosha, Wisconsin, hereinafter referred to as "this Code" or "Code".

16.02 DEFINITIONS

A. General.

1. **Scope** means unless otherwise expressly stated, the following terms shall, for the purposes of this Code, have the meanings stated in this Section.

2. **Interchangeability** means words stated in the present tense include the future; words stated in the

CODE OF GENERAL ORDINANCES, 2021 - KENOSHA, WISCONSIN

masculine gender include the feminine and neuter; the singular number includes the plural; and the plural includes the singular, except where the context indicates another interpretation.

3. Terms Defined Elsewhere means where terms are not defined in this Code and are defined in other City Ordinances, Codes, or ASHRAE and NFPA 70, such terms shall have the meanings ascribed to them therein in those Codes.

4. Terms Not Defined means where terms are not defined herein, or through the methods of interpretation authorized by this Section, such terms have ordinarily accepted meanings, such as the context indicates.

5. Parts means whenever the words Structure, Accessory Structure, Dwelling Unit, Dwelling, Premises, Building, Lodging House, or Lodging Room, are stated in this Code, they shall be construed as though they were followed by the words "or any part thereof".

6. "Shall" means the word "shall" is mandatory and not discretionary.

7. "May" means the word "may" is permissive. The phrase "may not" is mandatory.

8. Phrases means the phrase "used for" includes the phrases "arranged for", "designed for", "intended for", "maintained for", and "occupied for".

B. General Definitions.

Accessory Building/Structure means a detached Building or Structure on the same lot, with and of a nature customarily incidental and subordinate to the principal Building or Structure or use of the land, specifically including, but not limited to canopies, tents, trailers, a child's playhouse, a garden house, a greenhouse, a garage, a carport, a shed, fence, or retaining wall.

Appliance means a piece of equipment or machine usually operated electrically, especially for use in the home or for performance of domestic chores, specifically including, but not limited to, ovens, washing machines, clothes-drying machines, dish washers, refrigerator, or freezer.

Basement means that portion of a Building which is fifty percent (50%) or more below grade.

Bathroom means a room containing plumbing fixtures including a toilet and sink.

Bedroom means a room or space used or intended to be used for sleeping purposes.

Building means a combination of material to form a construction that is safe and stable, and adapted to permanent or continuous Occupancy in accordance with the Zoning Ordinance.

Carbon Monoxide Detector means a device that detects the presence of carbon monoxide gas.

Close/Closed/Closing means to vacate, cease operation or use. Secure means to prevent entry contrary to this Chapter.

Code of General Ordinances means City of Kenosha Code of General Ordinances.

Code Official means the Director of the Department of City Inspections, or any duly authorized designee of the Director.

Commercial means arranged, designed, used or intended to be used for Nonresidential Occupancy.

Debris means ashes, rubbish, trash, combustible and noncombustible waste materials, paper, cartons, scrap wood, rubber, scrap tires, scrap leather, tree branches severed from the tree and laying on the ground, accumulated Yard trimmings, metal cans, scrap metals, scrap glass or construction material.

Department means the Department of City Inspections.

Dwelling means a place of abode, a residence, a house or multiple Dwelling Units for use by one (1) or more Persons, but excluding hotels, motels, bed and breakfasts establishments and Lodging Houses.

Dwelling Unit means a single unit providing complete, independent living facilities for one (1) or more Persons, including permanent provisions for living, sleeping, eating, cooking and sanitation.

CODE OF GENERAL ORDINANCES, 2021 - KENOSHA, WISCONSIN

Efficiency Dwelling Unit means a Dwelling Unit with kitchen facilities and Bathroom facilities.

Egress Window shall have the meaning provided in the Wisconsin Administrative Code SPS 321.03.

Endanger(s) Safety means to injure or damage any Person or property, or the life, health and safety of any Person

Equipment means all piping, ducts, vents, control devices and other components of systems that are permanently installed and integrated in the Structure to provide control of environmental conditions, plumbing, electrical and heating systems, and other systems specifically regulated in this Code. Equipment does not include appliances.

Exterior Premises means the open space on the Premises or the portion of the Premises upon which there is not a Structure and those portions for which there is Structure, but it is not enclosed by windows or screens. Examples of Exterior Premises include, but are not limited to, open porches, decks, patios, and balconies.

Extermination means the control and elimination of an Infestation by poison spraying, fumigating, trapping or by any other pest elimination methods approved by the Code Official; by controlling harborage; and by removing or making inaccessible materials that serve as food.

Garbage means the animal or vegetable waste resulting from the handling, preparation, cooking and consumption of food.

Good Repair means maintained in a clean manner free from material defect.

Good Working Condition means capable of performing the task for which it was designed and in the manner intended by this Code.

Habitable Space means space in a Structure for living, sleeping, eating or cooking. Bathrooms, closets, halls, stairways, storage or utility spaces, and similar areas are not considered Habitable Spaces.

Imminent Danger means a condition which could cause serious or life threatening injury or death at any time.

Impervious To Water means constructed of concrete, cement block, terrazzo, brick, tile or other material approved by the Code Official and having tight-fitting joints, and prohibiting the movement of water.

Infestation means the presence, within a Structure of rats, mice, cockroaches, bedbugs, termites, squirrels, raccoons or bats.

Light means adequate lighting shall mean an intensity of 2-1/2 foot candles at a plane 30 inches above the floor line. The required intensity shall apply to both natural and artificial lighting.

Lodging House means a Structure containing at least three (3) Lodging Rooms the renters of each of which utilize a shared Bathroom.

Lodging Room means a rented room, excluding hotel or motel rooms, used primarily for sleeping and living purposes, which room excludes sanitary facilities.

Motor Vehicle(s) means "Motor Vehicle(s)" shall include mobile home, moped, motor bicycle, motorbus, motorcycle, motor-driven cycle, motor home, motor truck and Motor Vehicle as defined in Chapter 340, Wisconsin Statutes.

Nonresidential means arranged, designed, used or intended to be used for an Occupancy that is not Residential in nature.

Occupancy means the use of a Structure.

Occupant means any individual having lawful Occupancy, who is living, or sleeping or working in a Structure or having or exercising possession of a space within a Structure, whether or not a Tenant.

Open and Accessible Structure means a Structure which has no barrier to unlawful entry.

Openable Area means that part of a window, skylight or door which is available for unobstructed Ventilation and which opens directly to the outdoors.

Operator means any Person, other than the Owner, who has charge, care and control of a Structure or Premises, including maintenance responsibility, which is rented or offered for Occupancy.

Owner means any Person having a title to the Premises.

Person means any natural Person, firm, partnership, corporation, or legal entity.

Premises means any lot, whether or not improved with a principal or Accessory Building. When a lot is improved with a Structure, the lot and Structure shall be jointly referred to as Premises.

CODE OF GENERAL ORDINANCES, 2021 - KENOSHA, WISCONSIN

Provided means furnished, supplied, paid for or under control of the Responsible Person.

Raze the Structure means to demolish and remove the Structure and to restore the site to a dust-free and erosion-free condition.

Rent Means to permit, provide or offer possession or Occupancy of a Dwelling, Dwelling Unit, Premises or Structure to a Person who is not the legal Owner of record thereof.

Residential means arranged, designed, used or intended to be used for Residential Occupancy.

Responsible Person means the Owner, Operator or manager of any Structure or Premises. The term "Responsible Person" includes the mortgagee or land contract vendor if the Structure or Premises is subject to a registration requirement under **Chapter 28**. The term "Responsible Person" does not include the City, holders of mortgages subordinate to other mortgages, or holders of any liens including mechanics' liens, or utility liens, special assessments, special charges, or tax delinquencies, against the real estate that includes the Structure or Premises.

Roof Covering means the exterior roof cover or skin of the roof assembly, consisting of membrane, panels, sheets, shingles, tiles, or other materials designed as roofing materials.

Screening means a hedge, wall or fence to provide a visual separation and a physical barrier in compliance with the City Code of General Ordinances or Zoning Ordinance.

Secure. When used with respect to a Structure, the term means configured or arranged to prevent unauthorized entry or access.

Smoke Detector means a device that detects particles or products of combustion other than heat.

State Laws means the laws, rules and regulations of the State of Wisconsin.

Structure means any existing principal Building, whether or not inhabited or inhabitable, and any existing Accessory Building, such as a garage, which is not inhabited or inhabitable. Structure may also be included within the meaning of Premises, as indicated by the context.

Tenant means a Person occupying a rented Premises.

Unfit means a Structure that is unfit for habitation, Occupancy or use because of the degree to which the Structure is dilapidated, in disrepair or lacks maintenance; that is unsanitary, has a severe Infestation, contains filth and contamination; or that lacks Ventilation, illumination, sanitary or heating facilities, or other essential Equipment required by this Code.

Unlawful Structure means a Structure in whole, or in part, occupied by more Persons than permitted under this Code, or a Structure which is erected, altered or occupied contrary to State Law, or to the City Code of General Ordinances or Zoning Ordinance.

Unoccupiable Structure means a vacant Structure that has been damaged by fire, water, wind, animals, or vandalized and/or entered and inhabited and unfit for habitation or Occupancy.

Unsafe Equipment means any Equipment within the Structure or servicing the Structure which is in such disrepair or condition that such Equipment is unsafe for operation and use.

Unsafe Structure means a Structure that Endangers Safety for reason that it is in imminent danger of failure or collapse, or a part of it has failed or collapsed, or it is in a condition of decay or dilapidation, or it has the presence of explosives, explosive fumes or vapors, toxic fumes, gases or materials, or it is the subject of the operation of Equipment.

Ventilation means the natural or mechanical process of supplying conditioned or nonconditioned air to, or removing such air from, any space.

Weeds means weeds shall include plants listed as Prohibited Statewide and Restricted Statewide and in Kenosha County as per the Department of Natural Resources Chapter NR 40 and Regulated Plants and also nuisance and/or invasive plants such as *Chenopodium album* (lambquarter), *Toxicodendron radicans* (poison ivy), *Daucus carota* (Queen Anne's lace), *Setaria pumila* (yellow foxtail), *Taraxacum* (dandelions), *Carduus arvensis/Cirsium incanum/Cirsium arvense* (thistles), *Arctium minus* (common burdock), *Ambrosia artemisifolia* (common ragweed), *Ambrosia trifida* (giant ragweed), *Conyza canadensis* (Canadian horseweed), *Verbascum thapsus* (common mullein), *Elymus repens* (quackgrass), *Plantago aristat* (buckthorn plantain), *Portulaca oleracea* (pursland), *Chichorium intybus* (chicory), *Lysimachia nummularia* (creeping jenny), *Solidago sempervirens* (seaside goldenrod), *Glechoma hederacea* (creeping charlie), *Bromus tectorum* (cheatgrass), *Anthriscus sylvestris* (wild chervil), *Dipsacus fullonum/Dipsacus laciniatus* (teasel), and *Alliaria petiolata* (garlic mustard).

Workerlike means work executed in a skilled manner; e.g., generally plumb, level, square, in line, undamaged, without marring adjacent work and in accordance with generally accepted professional

CODE OF GENERAL ORDINANCES, 2021 - KENOSHA, WISCONSIN

procedures and construction standards.

Yard means an open space on a lot improved with a Structure.

Zoning Ordinance means the City of Kenosha Zoning Ordinance.

16.03 GENERAL

A. Scope. The provisions of this Code shall apply to all existing Residential and Nonresidential Structures and all Premises and constitute minimum requirements and standards for Premises, Structures, equipment, and facilities for Light, Ventilation, space, heating, sanitation, protection from the elements, life safety, safety from fire and other hazards, and for safe and sanitary maintenance; determine the responsibility of Owners, Operators, and Occupants; regulate the Occupancy of existing Structures and Premises, and provide for the administration and enforcement of this Code and provide for penalties for conviction of violation of this Code.

B. Intent. This Code shall be construed to secure its expressed intent, which is to ensure public health, safety and welfare insofar as they are affected by the Occupancy and maintenance of Structures and Premises. The establishment and enforcement of minimum Residential and Nonresidential property maintenance standards is necessary to preserve and promote the public interest and protect private property. This includes, among others, the protection of physical, aesthetic and monetary values. Existing Structures and Premises that do not comply with these provisions shall be altered or repaired by the Responsible Person to provide compliance with this Code.

C. Severability.

1. If any provision of this Code is, for any reason, held to be unconstitutional, invalid, or unenforceable by any court of competent jurisdiction, such judgment shall not affect the validity of the remaining provisions of this Code, which shall remain in full force and effect.

2. If the application of any provision of this Code is for any reason held to be an invalid application to a particular Premises or Structure by any court of competent jurisdiction, such provision shall continue to apply and remain in full force and effect to any Premises or Structure not specifically included in said judgment.

16.04 APPLICABILITY

A. General. The provisions of this Code shall apply to all matters affecting or relating to existing Structures and to Premises, as set forth herein. Where, in a specific case, different sections of this Code specify different requirements, the most restrictive shall govern. The provisions of this Code do not apply to the construction occurring pursuant to a valid building permit.

B. Conflict. In any case where a provision of this Code is found to be in conflict with a provision of the Zoning Ordinance or Code of General Ordinances, the provision which established the higher standard for the protection of the public health, safety and welfare shall prevail.

C. Responsibility for Maintenance. Except as otherwise specified herein, each Responsible Person or Tenant where the Tenant is identified as responsible in the Code shall be responsible for the maintenance of Structures and Premises under this Code and subject to penalty for conviction of any violation of this Code.

D. Prior Regulations. Equipment, systems, devices and safeguards required by a previous State Law, Ordinance or code under which the Structure was constructed, altered or repaired or Premises developed, shall be maintained in Good Repair and in good working order. The requirements of this Code are not intended to provide the basis for removal or abrogation of fire protection and safety systems and

CODE OF GENERAL ORDINANCES, 2021 - KENOSHA, WISCONSIN

devices in Good Repair and in good working order in Structures.

E. Application of Other Ordinances. Nothing contained herein shall be deemed to authorize the use of a Structure or Premises contrary to any other provision of the Code of General Ordinances or the Zoning Ordinance. Repairs, additions or alterations to a Structure, shall be done in accordance with the procedures and provisions of State Law and Chapter 9 of the Code of General Ordinances and National Fire Protection Association 70. Nothing in this Code shall be construed to cancel, modify or set aside any provision of the Zoning Ordinance.

F. Existing Remedies. The provisions in this Code shall not be construed to abolish or impair existing remedies of the City or its officers or agencies under State Laws or other City General or Zoning Ordinances relating to the removal or demolition of any Structure which is dangerous, unsafe and unsanitary or the abatement of public nuisances.

G. Workerlike. Repairs, maintenance work, alterations or installations which are caused directly or indirectly by the enforcement of this Code shall be executed and installed in a Workerlike manner and installed in accordance with the manufacturer's installation instructions.

H. Historic Buildings. The provisions of this Code shall apply to Structures designated by the Federal Government, State or City as historic Buildings. Any work to said Structures shall also comply with Section 15 of the Zoning Ordinance and Section 101.121, Wisconsin Statutes.

I. Referenced Statutes, Ordinances, Codes and Standards. The Statutes, Ordinances, codes and standards referenced in this Code shall be incorporated herein by reference and be a part of the requirements of this Code to the prescribed extent of each such reference and include amendments, renumbering and successor acts.

J. Requirements Not Covered By This Code. Requirements necessary for the strength, stability or proper operation of an existing Structure or equipment, or for the public safety, health and general welfare, not specifically covered by this Code, shall be determined by the Code Official, subject to a right of appeal to the Board of Housing Appeals pursuant to §16.13.

16.05 CODE OFFICIAL

A. Code Official. The Code Official shall have the authority to exercise the powers and duties of the position specified in this Code.

B. Code of Conduct. The Code Official, in administering and enforcing this Code, shall abide by the City of Kenosha's Code of Ethics.

16.06 POWERS AND DUTIES OF CODE OFFICIALS

A. General. The Code Official shall administer and enforce this Code.

B. Inspections. The Code Official has the power to inspect Premises and Structures to determine compliance with this Code. The Code Official is authorized to engage such expert opinion as deemed necessary to report upon unusual technical issues that arise in the course of their duties.

C. Right of Entry. The Code Official is authorized to enter Structures or Premises, at reasonable times, with the expressed or implied consent of the Owner, Operator or Occupant, to conduct administrative interior and exterior inspections for Code administration and enforcement and

CODE OF GENERAL ORDINANCES, 2021 - KENOSHA, WISCONSIN

Licensing/Permitting purposes specified in other ordinances. If entry is refused or not obtained, the Code Official is authorized to pursue recourse to obtain entry as Provided by law.

D. Cooperation. Every Owner, Operator and Occupant of a Premises shall cooperate with and facilitate reinspections of Premises at reasonable times pursuant to reasonable notice by the Code Official to determine Code compliance with an Order to Repair. Failure by said Owner, Operator or Occupant to cooperate with and facilitate such reinspections by the Code Official shall be a violation of this Code.

E. Obstruction. No Owner, or Operator of a Premises may deny the Code Official the right to enter and inspect any portion thereof under the control of an Occupant where such Occupant has consented to said entry and inspection.

F. Denial of Entrance. No Occupant of a Premises may obstruct the Owner thereof from complying with any order(s) of the Code Official made under authority of this Code. Obstruction includes the denial of entry into a Premises at reasonable times pursuant to reasonable notice.

G. Identification. The Code Official shall carry Department issued identification when entering and inspecting Premises in the performance of their duties under this Code and display such identification, when asked.

H. Notices and Orders. The Code Official may, as necessary, issue notices and orders to Responsible Persons and Tenants, where relevant, to obtain compliance with this Code.

I. Department Records. The Director of the Department is responsible for keeping official records of all business and activities of the Department specified in the provisions of this Code in accordance with State and City record keeping requirements.

16.07 APPROVAL OF ALTERNATIVE MATERIALS, METHODS AND EQUIPMENT

A. Modifications. Whenever there are practical difficulties involved in achieving strict compliance with the provisions of this Code, the Code Official shall have the authority to grant modifications for individual cases, Provided the Code Official shall first find that special individual reason makes enforcement of the strict letter of this Code impractical and the modification will be in compliance with the intent and purpose of this Code and that such modification does not lessen health, life and fire safety protection.

B. Alternative Materials, Methods and Equipment. The provisions of this Code are not intended to prevent the installation of any material or to prohibit any method of construction or equipment not specifically prescribed by this Code, Provided that any such alternative has been approved, as hereinafter Provided. An alternative material or method of construction or equipment shall be approved where the Code Official finds that the proposed alternative complies with the intent of the provisions of this Code, and that the material, method, or equipment proposed is, for the purpose intended, at least the equivalent of that prescribed in this Code in quality, strength, effectiveness, fire resistance, durability and safety.

C. Required Testing. Whenever there is insufficient evidence of compliance with the provisions of this Code, or evidence that a material, method or equipment does not conform to the requirements of this Code, or in order to substantiate claims of suitability for alternative materials, methods, or equipment, the Code Official shall have the authority to require tests to be made at no expense to the City, to determine compliance with this Code.

1. Test Methods. Test methods shall be generally recognized and accepted in the profession.

CODE OF GENERAL ORDINANCES, 2021 - KENOSHA, WISCONSIN

16.08 VIOLATIONS

A. Violations. It shall be a violation of this Code for any Responsible Person or Tenant, where relevant, to fail to timely comply with any of the provisions of this Code.

B. Prosecution of Violation. If the order to repair is not complied within a timely manner, the Code Official may initiate the appropriate proceeding at law or in equity to restrain, correct or abate such violation, and to require the removal or termination of the unlawful Occupancy of the Premises.

16.09 NOTICES AND ORDERS

A. Notice of Violation and Order To Repair. Whenever the Code Official determines that there has been a violation of this Code, notice shall be given to the Responsible Person or Tenant, where applicable, in the manner and form prescribed in this Code.

B. Form. Such notice and order shall:

1. Be in writing.
2. Include a statement of the violation with reference to the applicable provision(s) of this Code.
3. Contain an Order to Repair and allow a reasonable date certain for the violation to be corrected.
4. Include a notice of the appeal process.
5. Be served upon the Responsible Person or Tenant, where relevant.

C. Method of Service. Such notice and order shall be deemed to be properly served if a copy thereof is:

1. Personally served in the manner Provided for in State Statutes for service of process; or,
2. Sent by certified mail addressed to the last known address; or,
3. Sent by U.S. first class mail, postage prepaid, addressed to the last known address; and,
4. Posted in a conspicuous place on or about the main entrance to the Structure, where there is a Structure. If there is no Structure, such notice and order shall be posted on a conspicuous place on the Premises.

D. Recurring Violations.

1. Whenever there has been a notice of violation and order issued to the Responsible Person or Tenants, where relevant, for a violation of this Code, no further notice and order shall be necessary for any reoccurrence of the same or similar violation within a twelve (12) month period ensuing the date of the notice and order.

2. Whenever there has been a complaint and subsequent notice of violation and order issued to the Responsible Person or Tenants, where relevant, for any violation of this Code, or order issued pursuant to Charter Ordinance No. 26 as amended, no further notice and order shall be necessary upon a third complaint and violation of this Code, or order issued pursuant to Charter Ordinance No. 26 as amended, or any combination thereof, within a twelve (12) month period prior to the commencement of any reinspection fees and/or forfeiture action, or prior to seeking an injunction in a court of record.

E. Public Information. Notices and orders may be posted on the City Web Page for purposes of public information.

CODE OF GENERAL ORDINANCES, 2021 - KENOSHA, WISCONSIN

16.10 UNSAFE, UNFIT FOR OCCUPANCY, UNLAWFULLY OCCUPIED, VACANT SUBSTANDARD STRUCTURES AND UNSAFE EQUIPMENT

A. Closing of Structures and Equipment. If a Structure is found by a Code Official to be Unsafe, Unfit for Occupancy, Unlawful Occupied, Vacant Substandard or contain Unsafe Equipment, the Code Official is authorized to order the Structure and/or Unsafe Equipment Closed and secured by a date certain. Upon failure of the Responsible Person to Close the Structure or Unsafe Equipment within the time specified in the order, the Code Official may cause the Structure or Unsafe Equipment to be Closed through its employees or agents, or by contract or arrangement by private Persons and placarded.

B. Special Charges. Costs incurred in Closing or securing of Structure or Equipment shall be paid by the City. The Code Official shall recover the costs through special charges levied against the benefited property. A One Hundred Dollar (\$100.00) administrative fee for processing and administering the special charge shall be added to the special charge against the benefited property.

C. Notice and Order. Whenever the Code Official has ordered the Closing of a Structure or Unsafe Equipment, the Notice and Order shall be posted in a conspicuous place on or about the Structure or Unsafe Equipment affected by such notice and served on the Responsible Person as prescribed in Section 16.09.

D. Placarding. Upon failure of the Responsible Person served with a Notice and Order to abate, remove and/or Close the Structure or Unsafe Equipment in accordance with the order within the time given, the Code Official shall post on the Structure a placard bearing the words Unfit For Habitation/Occupancy, and on Unsafe Equipment a placard bearing the words Unsafe For Operation/ Use.

E. Prohibited Occupancy. Any Person who enters, inhabits, or who occupies or uses a placarded Structure or operates or uses placarded Unsafe Equipment, and any Responsible Person who authorizes or permits anyone to enter, inhabit or occupy or use a placarded Structure or operate or use placarded Unsafe Equipment shall be in violation of this Code. For purposes of performing inspection, replacement, repair, maintenance or restoration work required to bring the Structure or Unsafe Equipment into compliance with this Code, any Person may enter, occupy or use any Structure, or repair, replace or remove any Unsafe Equipment which has been Closed between the hours of 7:00 A.M. and 9:00 P.M., daily, or any other time authorized in writing by the Code Official.

F. Removal of Placard.

Any Person who defaces or removes a placard without the approval of the Code Official shall be in violation of this Code.

G. Securing and Maintaining an Unoccupiable Structure.

1. Securing an Unoccupiable Structure. The Responsible Person shall secure the Unoccupiable Structure against entry by adequately boarding up doors, windows, and other openings in a Workerlike manner so as to prevent illegal entry, vandalism, and/or damage. Securing a Structure shall be done in accordance with the Standards for Securing Structures set forth in Section 16.101 of this Code.

2. Maintaining Equipment in Unoccupiable Structures. The Responsible Person shall maintain Equipment at all times in a safe condition, inactivated or drained, so as to prevent the possibility of damage to the Structure by the failure of such Equipment, and so as to prevent hazardous and/or dangerous conditions.

H. Securing an Open and Accessible Structure. The Responsible Person shall secure an Open and Accessible Structure in accordance with the Standards for Securing Structures set forth in Section 16.101 of this Code.

CODE OF GENERAL ORDINANCES, 2021 - KENOSHA, WISCONSIN

16.101 STANDARDS FOR SECURING STRUCTURES

A. Boarding. Any Structure requiring securing shall be secured.

B. Fencing. When any Structure has been damaged by fire, water, illegal entry, or other cause when hazardous or dangerous conditions exist; or, when such Structure cannot be secured by conventional locking or boarding up windows and doors, such Structure shall be fenced off so as to prevent access and entry to the Structure and the area immediately surrounding the Structure within twenty-four (24) hours of the damage.

C. Special Charges. In the event the Responsible Person fails to comply with an order of the Code Official to secure the Structure in accordance with the Standards for securing Structures set forth in this Code, where applicable, the Code Official shall have the Structure properly secured. Costs incurred in securing the Structure shall be paid by the City and the Code Official shall recover such costs through special charges levied against the benefited property. A One Hundred Dollar (\$100.00) administrative fee for processing and administering the special charge shall be added to the special charge against the benefited property.

16.11 EMERGENCY MEASURES

A. Emergency Closing of a Structure. When, in the opinion of the Code Official, a Structure or Unsafe Equipment is unsafe, Unfit for Occupancy, unlawfully occupied or is a vacant substandard Structure under Section 16.10, and there is imminent danger of failure or collapse of a Structure, or a part of any Structure has fallen and the occupation of the remaining Structure will Endanger Safety, or there is actual or potential danger to the Occupants, users or those in the proximity of any Structure, the Code Official is authorized and empowered to order and require the Responsible Person to Close the Structure. The Code Official shall, in such event, cause such Structure to be placarded at each entrance with a placard bearing the words: Unfit For Habitation/Occupancy. In the event the Code Official has required a Structure to be Closed, it shall be unlawful for any Person to enter, inhabit, occupy or use such Structure, except for the purpose of securing the Structure, making the required repairs, removing the hazardous condition, demolishing the Structure, or otherwise securing compliance with an order of the Code Official.

B. Emergency Securing and Repairs. Notwithstanding any other provisions of this Code, in the event the Code Official has required the Emergency Closing of a Structure, or identified an Open and Accessible Structure which Endangers Safety, the Code Official may cause the securing of the Structure to render such Structure temporarily safe, whether or not the procedure described in this Code for providing notices and orders has been instituted; and, shall cause such other reasonable action to be taken as the Code Official deems necessary to meet such emergency. The Code Official may also employ the necessary labor and materials to perform or cause to be performed emergency repairs as expeditiously as possible.

C. Closing Public Streets, Sidewalks, Ways and Places. The Code Official may temporarily order the authority having jurisdiction to Close streets, sidewalks, public ways and public places adjacent to Unsafe Structures, and prohibit the same from being used while any Unsafe Structure Endangers Safety.

D. Special Charges. Costs incurred in the performance of emergency repairs shall be paid by the City and the Code Official shall recover the costs through special charges levied against the benefited property. A One Hundred Dollar (\$100.00) administrative fee for processing and administering the special charge shall be added to the special charge against the benefited property.

16.12 RAZING STRUCTURES

A. Administration and Enforcement. The Code Official is authorized to administer and enforce Section 66.0413, Wisconsin Statutes, entitled Razing Buildings, which is incorporated herein by reference

CODE OF GENERAL ORDINANCES, 2021 - KENOSHA, WISCONSIN

as if fully set forth herein, and any successor statutes.

B. Failure to Comply With the Raze Order. If the Owner of a Structure fails or refuses to comply with the raze order within the time prescribed, the Code Official may proceed to post the property as unfit for human habitation, Occupancy or use, secure the Structure or any portion thereof, and to Raze the Structure or any portion thereof or contract with a private contractor for such work.

C. Special Charges. The Code Official shall recover all costs to Raze the Structure through special charges levied and to be collected as a delinquent tax against the real estate upon which the Structure is located. Such special charge shall be a lien upon the real estate. A One Hundred Dollar (\$100.00) administrative fee for processing and administering the special charge shall be added to the special charge against the benefited property.

16.13 BOARD OF HOUSING APPEALS

A. Appeal and Fee. Any Person receiving a notice of violation and order which has been issued in connection with the enforcement of any provision of this Code except for an order to raze or order for revocation or suspension under Section 16.14 or an order under Section 16.151 and aggrieved thereby, may appeal the order and shall be granted a hearing on the matter before the Board of Housing Appeals, provided that such Person shall file in the Office of the Department of City Inspections a written notice of appeal and request for hearing and setting forth a brief statement of the grounds therefor within twenty (20) calendar days after the day the notice of violation and order was posted. Upon receipt of such appeal, the Board of Housing Appeals shall set a time and place for such hearing and shall give the petitioner written notice thereof. At such hearing, the petitioner shall be given an opportunity to be heard and to show why such notice of violation and order should be modified or withdrawn. No appeal to the Board of Housing Appeals shall be deemed perfected or shall be heard until the appellant pays an appeal fee of Twenty-five Dollars (\$25.00).

16.14 LODGING HOUSES

A. Prohibition. No Person shall operate a Lodging House, or shall occupy or Rent to another for Occupancy any Lodging Room in any Lodging House, except in compliance with the applicable provisions of this Chapter.

B. Requirements.

1. Sanitary Maintenance. The Responsible Person of every Lodging House shall be responsible for the sanitary maintenance of the entire Premises except that the Tenant shall be responsible for the sanitary maintenance of the Lodging Room under their control.

2. Cooking Facilities. Cooking facilities are permitted, but not required in Lodging Houses. Cooking facilities are subject to the following:

a. Stoves may be used if there is a sink with hot and cold running water within the room in which contained. Cooking stoves shall not be located closer than five feet (5') from a bed or upholstered furniture, or windows with curtains.

b. Portable, self-heating hotplates shall not be used.

3. Bathroom Facilities

a. Every Lodging House shall contain at least one toilet, a Bathroom sink and a bathtub or shower for each eight (8) Persons residing therein.

b. Bathrooms serving lodging units shall have access by traversing not more than one (1) flight of stairs and shall have access from a common hall or passageway.

CODE OF GENERAL ORDINANCES, 2021 - KENOSHA, WISCONSIN

4. Heat Supply. Every lodging unit shall have heat furnished to the Occupants with a permanently affixed heating system which maintains a temperature of not less than 68°F in all habitable rooms and Bathrooms when the outside temperature is at or above 0°F and no less than 60°F, when the outside temperature is below 0°F. Portable space heaters shall not be used as the main heat supply. Underwriters Laboratories listed portable space heaters shall be permitted as a temporary source of heat only while the permanently affixed heat source is being repaired.

5. Lodging Houses. Every permittee of a Lodging House shall:

a. Make available to the Occupants the name of Person that may be called for emergencies. The name(s) with the telephone numbers shall be posted in a conspicuous place readily accessible to the Occupants. The names with the telephone numbers shall be revised periodically to maintain accurate information at all times.

b. Identify each Lodging Room with numbers or letters on the outside of each room.

C. Permit. No Person may operate a Lodging House unless he/she holds a valid Lodging Housing Permit or Temporary Lodging House Permit issued by City in the name of the Operator or Owner and for the specific Dwelling or Dwelling Unit. The annual fee for Lodging House Permits shall be Two Hundred Fifty (\$250.00) Dollars. The fee for a Temporary Lodging House Permit for all Lodging Houses shall be Fifty (\$50.00) Dollars. The fees Provided herein are not subject to proration. The Operator or Owner shall apply to the City Clerk for such permit, which shall be issued by the City Clerk, or designee, upon approval of City Inspections upon compliance by the Operator or Owner with the applicable provisions of this Ordinance. Any unexpired permit shall be displayed in a conspicuous place within the Lodging House at all times. No such permit shall be transferable. Every Lodging House Permit shall expire on the 31st day of August. Every Temporary Lodging House Permit shall expire thirty (30) days after issuance.

D. Penalties for Failure to obtain Required Permit or Inspections/Reinspection.

1. The Responsible Person of the Lodging House shall contact the Department of City Inspections and schedule an annual site inspection. Inspections must be conducted prior to August 1st of each year. The annual site inspection shall include access to each Lodging Room, common areas, Basement and Exterior Premises.

2. If all violations are not corrected by August 31st, the Responsible Person will be subject to any or all of the following:

a. The Responsible Person will be required to obtain a Temporary Lodging House Permit. All Temporary Lodging House Permits expire on September 30th. If a Temporary Lodging House Permit is not obtained, the Responsible Person shall be subject to any or all of the following:

(1) Citations and/or summons and complaint for failure to obtain a Lodging House license.

(2) Revocation, non-renewal or suspension of Lodging House license.

b. Daily reinspection fees for health and safety violations until corrected.

3. If any violations are not corrected by September 30th and the Temporary Lodging House Permit expires, the permit will be revoked, not renewed, or suspended for just cause. If the Lodging House continues to be occupied, citations and/or summons and complaints may be issued for operating a Lodging House after expiration of license. Reinspection fees, citations, and/or summons and complaints may be issued for failure to make required repairs of property maintenance violations.

E. Appeal - Permit Denial. Any Person whose application for a permit to operate a Lodging House has been denied may request and shall be granted a hearing on the matter before the Board of Housing Appeals, under the procedure Provided by Section 16.13.

CODE OF GENERAL ORDINANCES, 2021 - KENOSHA, WISCONSIN

F. Revocation of Permits.

1. Standards for Revocation. A permit issued pursuant to this Section may be revoked, not renewed, or suspended for just cause. "Just Cause" shall mean the unfitness of the Operator or Owner, unfitness of the Premises, improper operation, misrepresentation or a material error in the application for an original or renewal permit. Unfitness of the Operator or Owner includes, but is not limited to, mental incompetence, failure or inability to be regularly present on the Premises to personally supervise the operation, or violation of a relevant criminal law or local ordinance, regardless of whether conviction in a court ensues. Unfitness of the Premises includes, but is not limited to, any single event or condition which makes the premise unsafe or unsuitable for Occupancy, or any series of minor violations occurring over time, or any multiple minor violations occurring within Close time proximity. Improper operations includes, but is not limited to, permitting any of the following on or about the Premises: loitering for prostitution, illegal drug sales, loitering of groups of people which result in profane language, fights in public, battery, or other disorderly conduct.

2. Procedure.

a. Complaint. Any citizen, the City Clerk or Code Official may sign a complaint seeking the revocation, nonrenewal, and/or suspension of a permit issued pursuant to this Code. Complaints shall state with specificity, the events or series of events forming the basis of the complaint.

b. Summons. The permittee shall be served in Person or by certified mail, return receipt requested, or by any means authorized by statute to serve a summons under Wisconsin Statutes Chapter 802 or, with a copy of the complaint and a summons, signed by the Chair of the Board of Housing Appeals, directing the permittee to appear before the Board of Housing Appeals.

c. Hearing. If the permittee does not appear at the time dictated in the Summons, default may be entered and the permit revoked. If the permittee appears at the time dictated in the Summons and demands a hearing, a hearing date will be set. Within forty-five (45) days of the date of the appearance of the permittee, the Board of Housing Appeals shall hold an evidentiary hearing. The proceeding shall be recorded by either a court reporter or on videotape. If the complaint is brought by the City Clerk or Code Official, the Office of the City Attorney shall prosecute said complaint.

d. Decision. The Board of Housing Appeals shall issue a decision in writing detailing its findings of fact and the Order of the Board. The decision shall be delivered to the complainant and the permittee by personal service, certified mail, return receipt requested, or equivalent private delivery service, or in the case of the permittee, by posting on the Premises being the subject of the complaint.

e. Effect. Upon revocation of the permit, a previously permitted Lodging House shall cease operation, and no Person may occupy for sleeping or living purposes any Lodging Room therein.

3. Revocation of Permit. Any Person whose permit to operate a Lodging House has been revoked, or who has received notice from the Board of Housing Appeals that his/her permit is to be revoked may appeal such revocation to the Circuit Court in the manner prescribed by Section 753.04, Wisconsin Statutes.

16.141 PROHIBITION OF RESIDENTIAL TENANCIES OF LESS THAN SEVEN DAYS

A. Findings.

The City of Kenosha Common Council finds that the City has transient residents, many of whom occupy rental housing within the City and that the current Code of the City lacks sufficient incentives for owners and sublessors of residential real estate to regulate the conduct of their tenants. The Common Council further finds that current City Code provisions must be enforced to halt the proliferation of such conditions and that the public health, safety, welfare, good order and governance of the City will be enhanced by enactment of the regulations set forth in this chapter, which regulations are remedial in nature and effect, and further finds that any residential tenancy for less than seven days is undesirable because of the transient nature.

CODE OF GENERAL ORDINANCES, 2021 - KENOSHA, WISCONSIN

B. Definitions.

1. Hosting Platform. A person or entity that provides a means through which an owner may offer a Residential Dwelling Unit for tourist or transient use. This service is usually provided through an online platform and generally allows an Owner to advertise the Residential Dwelling Unit through a website provided by the Hosting Platform and provides a means for potential tourist or transient users to arrange tourist or transient use and payment, whether the tourist or transient pays rent directly to the Owner or to the Hosting Platform.

2. "Lessee" shall mean a person who leases a residential dwelling.

3. "Primary Residence" shall mean the residence of a person is the place where the person's habitation is fixed, without any present intent to move, and to which, when absent, the person intends to return.

4. "Residential Dwelling" shall mean any building, structure, or part of the building or structure, that is primarily used and occupied for human habitation or intended to be so used and includes any appurtenances belonging to it or usually enjoyed with it.

5. "Residential Dwelling Rental" shall mean a residential dwelling that is offered for lease for periods of 7 consecutive days or longer in exchange for money or other remuneration, barter or other benefit.

6. "Short-term Residential Dwelling Rental" shall mean a residential dwelling that is offered for lease for periods of less than 7 consecutive days in exchange for money or other remuneration, barter or other benefit.

7. "Sublease" shall mean the lease of a residential dwelling made by a person who is himself a renter of that residential dwelling, or the act of granting or taking such a lease.

8. "Sublessee" shall mean a person who leases a residential dwelling from a lessee.

C. Prohibitions.

1. Short-term residential dwelling rentals are prohibited.

2. A Sublease of residential real estate is prohibited unless all the following apply:

(a) The sublease is in writing;

(b) The sublease is for a period of greater than seven days;

(c) The sublessee financially personally guarantees the rent due under the underlying lease;

(d) The sublessee is personally responsible for any residential code violations that occur during the sublessee's tenancy;

(e) The original lessee or party responsible for paying rent to the property owner or its agent resides on the premises with the sublessee; and

(f) The lessee notify the City of such arrangement and deliver the written lease and sublease to be on file with the City Clerk.

CODE OF GENERAL ORDINANCES, 2021 - KENOSHA, WISCONSIN

D. Exceptions. The following arrangements are exempt from this ordinance:

1. Community-Based Residential Facilities;
2. Group homes as defined and protected by the Federal Housing Administration;
3. Facilities serving people with developmental disabilities;
4. Assisted living facilities;
5. Nursing homes;
6. Home health and hospice agencies;
7. Hotels and motels;
8. Bed and breakfasts;
9. Licensed boarding houses; and
10. House guests of a primary resident.
11. Home sharing facilitated by a Hosting Platform

E. Inspection and Enforcement. City Inspections and City of Kenosha Police Department shall have the authority to enforce the provisions of this section. Citizens may deliver written or verbal complaints of violations of this section to the City Clerk.

F. Penalties. Any person, organization, company, party, firm, corporation, or other entity violating any provision of this section shall be punished by payment of a forfeiture not less than two hundred fifty dollars (\$250) per day, nor more than five hundred dollars (\$500) per day, together with costs of prosecution.

16.15 RENT WITHHOLDING

A. Authority To Withhold Rent; Appeal of Authorization To Withhold Rent.

1. Deposit In Escrow. Notwithstanding any other provision of law or any agreement, whether oral or written, if a Responsible Person of real property fails or neglects to comply with an order of the Code Official to correct a violation of this Code, then upon the expiration of the time given in an order to correct those violations, or the expiration of any extensions of time which may be granted by the Code Official, the Code Official, upon application of the Tenant, may authorize the Tenant, as of the date of application, to deposit rental payments into an escrow account designated by the Director of Finance. Notwithstanding the above, a Tenant shall not be authorized to withhold Rent if the only violation of this Code is the failure to comply with an exterior paint order, replacement or repair of siding, seeding or sowing of grass, and replacing concrete foundations and fence posts during Winter, or if the Tenant has Rent for that property which is unpaid past the due date. The Tenant may commence Rental deposits into the escrow account upon authorization by the Code Official Provided that payment is made prior to service of a five (5) day quit or pay notice or prior to a service of a fourteen (14) day termination notice given by the lessor under Chapter 704, Wisconsin Statutes. The Responsible Person shall be notified of Rent withholding authorization by the Code Official by first class mail within five (5) days of said authorization.

2. Appeal From Tenant Authorization By Owner. Tenant authorization to deposit rental payments into an escrow account pursuant to Section 16.15 shall be stayed if an appeal of Rent withholding authorization is made by the Responsible Person to the Board of Housing Appeals in the manner and within the time period Provided by Section 16.13. The Board shall have the power to affirm or reverse the authorization of Rent withholding or require the return to the Responsible Person of all or part of the Rent paid to the City escrow account or postpone to a future date the commencement of Rent withholding. The Board may determine which, if any, of the violations of this Code was caused by the act or omission of the Tenant and make a specific finding of such fact. Such finding shall not relieve the responsible party under

CODE OF GENERAL ORDINANCES, 2021 - KENOSHA, WISCONSIN

this Code from the duty to comply therewith in a timely manner. The Board shall authorize Rent withholding under this Section in such instances to continue only until violations are certified as corrected by the Code Official. If a Rent payment shall become due during the pendency of an appeal, the Tenant shall deposit the rental payment into the escrow account when due. If the Board does not authorize Rent withholding, all money deposited in the escrow account which is due to lessor shall be paid to the lessor without deduction of administrative fees from the account. If the Board does authorized Rent withholding, administrative fees as herein authorized shall be deducted by the City prior to the making of any other disbursements.

3. Receipt of Rent Withheld. Upon acceptance of Rent, receipt will be mailed to the Responsible Person or their agent and serve as a notice that Rent has been paid, certified mail, return receipt mail requested or equivalent private delivery service. Within five (5) days of the due date, if Rent remains unpaid, notice of nonpayment will be mailed to the Responsible Person or their agent by certified mail, return receipt requested or equivalent private delivery service.

4. Deposit by Tenant. The right of the Tenant to deposit rental payments into the escrow account established by this Section shall not preclude or adversely affect in any way the right of lessor to use any of the rights and remedies Provided by the laws of the State of Wisconsin pertaining to the relationship of landlord and Tenant, including, but not limited to, commencing eviction proceedings after notice of nonpayment of Rent has been sent. The Department has no responsibility for the collection of Rent which is not paid when due.

5. Escrow Account. The Director of the Finance Department is authorized to create a special revenue fund for the purpose of depositing rental payments collected which shall be held in an escrow account and released as set forth in Subsection B.

B. Release of Funds.

1. During Pendency of Withholding. Monies deposited in the escrow account, during pendency of withholding:

a. Shall be released to the Code Official by the Director of the Finance Department to cover administration expenses in the following amounts:

(1) Thirty Dollars (\$30.00) to establish the account, to be assessed only after Rent withholding has been authorized by the Code Official.

(2) Five Dollars (\$5.00) per month, payable each month, to maintain the account if no transaction occurs during the month.

(3) Fifteen Dollars (\$15.00) per transaction made by the Director of Finance from this escrow account.

(4) Thirty Dollars (\$30.00) to Close the account.

b. Shall be released at the discretion of the Code Official to pay utilities where the utility costs are included as part of the Rent.

c. May be released at the discretion of the Code Official to reimburse any City Department or to pay any private contractor hired by the City, for the costs of razing the Building, Closing or securing vacant and open Dwelling Units, and the cutting of long grass and Weeds.

d. May be released at the discretion of the Code Official to the Responsible Person, upon presentation of itemized receipts for reasonably necessary work completed at the direction of the Code Official.

2. After Completion of Required Repairs. After all repair orders of the Code Official which formed the basis for the Rent withholding are complied with to the satisfaction of the Code Official, the Code

CODE OF GENERAL ORDINANCES, 2021 - KENOSHA, WISCONSIN

Official, after applicable deductions under this Section, shall release all remaining funds which had been deposited by the Tenant for that lessor, to the Owner of record as recorded with the Register of Deeds. The Owner of record shall appear personally before the Director of Finance or his/her designee during regular business hours for receipt of the funds.

C. Enforcement, Notice And Hearings. The provisions of this Code relating to enforcement, notice and hearings applicable to orders issued by the Code Official are made applicable to orders issued and the release of funds by the Code Official pursuant to this Code.

D. Harassment. No Person may use any provision of this Section to harass any other Person. To harass will include, but not be limited to, making spurious complaints to the Code Official or any other law enforcement official, terminating a tenancy or giving notice preventing the automatic renewal of a lease, or constructively evicting a Tenant by any means, including the termination or substantial reduction of heat, water or electricity to the Dwelling Unit, or increasing, without good cause, the Rent to a unit by more than ten percent (10%) over the rental rate in effect at the time during which the Tenant applied for Rent withholding. "Good Cause", as used in this Section shall include the nonpayment of Rent to the lessor or to the escrow account, or the commission of waste. "Good Cause", as used in this Section, shall mean that the lessor must show a good reason for his/her action, other than one related to or caused by the operation of this Section, such as normal rental increases due to tax increases or increased maintenance costs.

E. Exemptions. This Section shall not apply to Owner-occupied two unit Dwellings or Lodging Houses having a Lodging House Permit granted pursuant to this Code.

F. Prohibited Conduct.

1. Any Person who, contrary to this Section, accepts rental payments for Premises subject to authorized Rent withholding, whether the rental payments are tendered by or on behalf of the Tenant occupying the Premises at the time Rent withholding is authorized or by, or on behalf of, any subsequent or other Tenant who occupies the Premises during the existence of such Rent withholding authorization, shall be in violation of this Code. Each payment accepted shall constitute a separate violation.

2. Any Person who, contrary to this Section, engages in discrimination or harassment shall be in violation of this Code.

16.151 CHRONIC NUISANCE PROPERTY

A. Findings. The Common Council of the City of Kenosha finds that any Premises that has generated two (2) or more calls for police services, resulting in arrest or the issuance of citations for nuisance activities, has received more than the level of general and adequate police service and has placed an undue and inappropriate burden on the taxpayers of the City. Therefore, the Common Council directs the Chief of Police and the Director of City Inspections, as Provided in this Section, to charge the Owners of such Premises the costs associated with abating the violations at Premises where nuisance activities chronically occur.

B. Enforcement By Injunction. The regulations of this Section may be enforced by means of an injunction.

C. Definitions. For purposes of this Ordinance, the following words and phrases shall have the meanings Provided.

CODE OF GENERAL ORDINANCES, 2021 - KENOSHA, WISCONSIN

- 1. Nuisance Activity** shall mean any of the following activities, behaviors or conduct whenever engaged in by Premises Owners, Operators, Occupants or Persons associated with a Premises:
- a. An act of harassment as defined in Section 947.013, Wisconsin Statutes.
 - b. Disorderly Conduct as defined in Subsection 11.02 M. of the Code of General Ordinances, or Section 947.01, Wisconsin Statutes.
 - c. Battery, substantial battery or aggravated battery as defined in Section 940.19, Wisconsin Statutes.
 - d. Indecent conduct as defined in Subsection 11.02 D. of the Code of General Ordinances, or Section 944.20(1), Wisconsin Statutes.
 - e. Keeping a place of prostitution, or leasing a Building for the purposes of prostitution as defined in Section 11.03 of the Code of General Ordinances, or Section 944.34, Wisconsin Statutes.
 - f. Littering of Premises as defined in Section 11.02 U. of the Code of General Ordinances.
 - g. Theft as defined in Subsection 11.02 W. of the Code of General Ordinances, or Section 943.20, Wisconsin Statutes.
 - h. Arson as defined in Section 943.02, Wisconsin Statutes.
 - i. Possession, manufacture or delivery of a controlled substance or related offenses as defined in Chapter 961, Wisconsin Statutes.
 - j. Gambling as defined in Section 11.04 of the Code of General Ordinances or Section 945.02, Wisconsin Statutes.
 - k. Keeping a prohibited dangerous animal as defined in Chapter 14 of the Code of General Ordinances.
 - l. Trespassing as defined in Sections 11.022 or 11.036 of the Code of General Ordinances or Section 943.13, Wisconsin Statutes, or Criminal Trespass to Dwelling as defined in Section 943.14, Wisconsin Statutes.
 - m. Discharge of a firearm as defined in Subsection 11.02 A. of the Code of General Ordinances.
 - n. The production or creation of excessive noise as defined in Section 11.14 of the Code of General Ordinances.
 - o. Loitering as defined in Sections 11.034 or 11.035 of the Code of General Ordinances.
 - p. Public drinking as defined in Section 11.026 of the Code of General Ordinances.
 - q. Obstruction/interference with Police or Fire personnel as defined in Subsection 11.02 Q. of the Code of General Ordinances.
 - r. Any other offense against good order and conduct as defined in Chapter 11 of the Code of General Ordinances or Chapter 947, Wisconsin Statutes.
 - s. Any act of aiding and abetting, as defined in Section 939.05, Wisconsin Statutes, any of the activities, behaviors or conduct enumerated in Sections a. to t. above.
 - t. Any conspiracy to commit (as defined in Section 939.31, Wisconsin Statutes) or attempt to commit, as defined in Section 939.32, Wisconsin Statutes, any of the activities, behaviors or conduct enumerated in Sections a. to s. above.

2. Person Associated With shall mean any Person who, whenever engaged in a Nuisance Activity, enters, patronizes, visits or attempts to enter, patronize or visit, or waits to enter, patronize or visit, a Premises or Person present on a Premises, including any officer, director, customer, agent, employee or independent contractor of a Premises Owner.

CODE OF GENERAL ORDINANCES, 2021 - KENOSHA, WISCONSIN

D. Procedure.

1. Whenever the Chief of Police determines two (2) or more nuisance activities of the types defined in paragraph 16.151 C.1. have occurred at a Premises, resulting in arrests and/or the issuance of citations and/or verified by written police reports, on separate days during a sixty (60) day period, the Chief of Police may notify the Premises Owner in writing that the Premises is in danger of becoming a chronic nuisance. This notice shall be deemed to be properly delivered if sent either by first class mail to the Premises Owner's last known address, or if delivered in Person to the Premises Owner. If the Premises Owner cannot be located, the notice shall be deemed to be properly delivered if a copy of it is left at the Premises Owner's usual place of abode in the presence of some competent member of the family at least fourteen (14) years of age, or a competent adult currently residing there and who shall be informed of the contents of the notice. If a current address cannot be located, it shall be deemed sufficient if a copy of the notice is sent by first class mail to the last known address of the Owner as identified by the records of the City Assessor or the Director of City Inspections. This notice shall contain:

- a. The street address or legal description sufficient for identification of the Premises.
- b. A description of the nuisance activities that have occurred at the Premises and a statement indicating that the cost of future enforcement may be assessed as a special charge against the Premises.
- c. A statement that the Premises Owner shall, within thirty (30) days, respond to the Chief of Police either with an appeal or to propose a written course of action to abate the nuisance activities which is acceptable to the Chief of Police.

2. Whenever the Chief of Police determines that an additional Nuisance Activity has occurred at a Premises for which notice has been issued pursuant to paragraph D.1. above, and either this Nuisance Activity has occurred not less than thirty (30) days after notice has been issued or a course of action as required by subparagraph D.1.c. has not been submitted, the Chief of Police may charge any Premises Owner found to be in violation of this Section the costs of enforcement in an amount not to exceed Two Hundred Dollars (\$200.00). All costs so charged are a lien upon such Premises and may be assessed and collected as a special charge. A One Hundred Dollar (\$100.00) Administrative Fee shall be added to the special assessment against the property, as Provided in Subsection F.

E. Violation. Each subsequent incident of nuisance activities shall be deemed a separate violation.

F. Cost Recovery. Upon receipt of a notice from the Chief of Police issued pursuant to paragraph D.2., the Director of City Inspections shall charge any Premises Owner found to be in violation of this Section the costs of enforcement, including administrative costs, in full or in part. All costs so charged are a lien upon such Premises and may be charged and collected as a special charge. A One Hundred Dollar (\$100.00) Administrative Fee shall be added to the special charge against the benefited property.

G. Appeal. Appeal of the determination of the Chief of Police pursuant to paragraphs D.1. or D.2., or the action of the Director of City Inspections imposing special charges pursuant to Section F. against the Premises, may be submitted to the Board of Housing Appeals in the manner and under the procedure Provided in Section 16.13 of this Code. However, if no petition for hearing is filed within thirty (30) days following receipt of the notice Provided for in Subsection D. by the Premises Owner, the Petitioner's right herein Provided to a hearing shall be deemed waived by the Petitioner and the hearing petition shall be voided as untimely.

16.16 GENERAL PROPERTY MAINTENANCE REQUIREMENTS

A. Scope. The provisions of this Code shall govern the minimum requirements and the

CODE OF GENERAL ORDINANCES, 2021 - KENOSHA, WISCONSIN

responsibilities of Persons for maintenance of Premises (including existing Structures, exterior Premises and equipment), whether occupied or vacant.

B. Responsibility. The Responsible Person shall maintain the Premises in compliance with this Code. A Person shall not occupy a Premises, or permit another Person to occupy a Premises that does not comply with the requirements of this Code. Occupants of a Premises are responsible for caring for and maintaining in a clean, safe and sanitary condition that part of the Premises that they occupy and control. All Responsible Persons shall be jointly and severally responsible for securing compliance of their Premises with this Code.

16.17 EXTERIOR PREMISES

A. Exterior Storage. All exterior Premises, including the abutting right-of-way, lawn park areas, alleyways to the middle of the alley, and open porches and decks, shall be maintained by the Responsible Person in an orderly manner. All exterior storage shall be of weather-proof and water-proof material or stored in a weather-proof or water-proof container with lid.

1. The following items are permitted for outside storage subject to noted limitations:
 - a. Property maintenance equipment for use on Premises;
 - b. Gardening equipment and supplies;
 - c. Outdoor entertainment equipment;
 - d. Toys;
 - e. Pet enclosures and equipment;
 - f. Waste receptacles in accordance with Section 5.06 and Section 16.20 of the Code of General Ordinances;
 - g. Weatherproof storage containers with lids;
 - h. Recreation vehicles, campers, boats and trailers that are in Good Repair and currently licensed if required;
 - i. Tarpred items that are not otherwise prohibited, provided that the tarps are not be torn, ripped, or in disrepair and are tightly moored or made fast around the stored item.

2. The following items are expressly prohibited and are not permitted for outside storage:
 - a. Motor vehicle, boat, airplane, and recreational vehicle parts;
 - b. Tires;
 - c. Uncontained recyclable materials;
 - d. Building materials that have not been integrated into the Structure for thirty (30) days;
 - e. Animal feces, which have been present for more than twenty-four (24) hours;
 - f. Household furniture not designed for exterior use;
 - g. Appliances, furnaces, water heaters, water softeners;
 - h. Exterior storage of materials and equipment on residentially zoned property that are used in Commercial activities;
 - i. Garbage, trash and Debris not contained or stored pursuant to Chapter 16.20;
 - j. Accumulation of brush, fallen trees, rock, sand, gravel or dirt that have not been integrated into the landscaping for thirty (30) days;
 - k. Scrap metal.

3. Temporary dumpsters may not remain on the Premises for more than thirty (30) days. Dumpsters

CODE OF GENERAL ORDINANCES, 2021 - KENOSHA, WISCONSIN

shall be maintained to prevent Debris from blowing out of or overflowing from the dumpster. Dumpster shall not be placed in the Vision Clearance Triangle. For purposes of this paragraph, the Responsible Person and the Owner of the temporary dumpster are jointly liable for compliance.

4. Items stored on trailers must be covered with a tarp pursuant to subparagraph. 16.17 A(1)(j) or in a container with lid. No Garbage may be stored on trailer.

B. Unpaved Lawn Park Areas. The unpaved public lawn park areas abutting private property between the curb and lot line shall be maintained by the abutting property Owner in conformance with Section 5.11 of the Code of General Ordinances.

C. Maintenance of Alleys. All alleys abutting private property between the center of the alley and the lot line, shall be maintained by the abutting property Owner in accordance with this Code.

D. Grading and Drainage. All Premises shall be graded and maintained to divert water away from any principal Structure.

E. Sidewalks, Walkways, Stairs, Driveways and Parking Facilities. Private sidewalks shall be maintained in accordance with the standards for public sidewalk maintenance required in Section 5.11 of the Code of General Ordinances. Walkways, stairs, driveways, and parking facility areas shall be maintained in Good Repair. Walkways, driveways, and parking facilities shall be repaired or replaced with like material. When fifty (50) percent or more of sidewalk, walkway, stairs, driveways, and parking facilities are replaced it shall be replaced with hard surface material approved by the inspector. Parking facilities with more than five (5) parking spaces shall comply with the requirements of Section 5.08 of the Code of General Ordinances. Sidewalks and parking facilities of multi-family properties shall be maintained free of all accumulation of ice and of accumulation of snow after a snowfall of more than four inches (4").

F. Weeds. All exterior Premises shall be kept free from Weeds which equal or exceed eight inches (8") in height as defined in this Code. Plants such as goldenrod and milkweed will be permitted if included in an approved Natural Landscape Permit per Subsection 16.17 G. Where weed cutting or removal is not performed by the Responsible Person, Weeds shall be cut by the Code Official and the cost plus a One Hundred Dollar (\$100.00) administrative fee shall be recovered per Chapter 16.17 G.

G. Landscaping. Landscaping, plantings and other decorative surface treatments, including species of grass common to Southeastern Wisconsin, shall be installed and maintained in all court and Yard areas in accordance with generally accepted landscaping practices in Southeastern Wisconsin. Unless granted a variance for a natural lawn from the Code Official, grass shall be maintained to a height not to exceed eight inches (8"). Plantings, including, but not limited to grasses, trees and shrubs shall be maintained so as not to present hazards to Persons or vehicles traveling on public right-of-ways Yard shall not have ruts and potholes caused by the parking of Motor Vehicles.

Application for approval for a natural lawn, if desired, shall be made by the Responsible Person on a form issued by the Department. The application shall state with specificity the dimensions of the area sought for variance, along with a diagram showing the position of the area relative to sidewalks, driveways, streets, alleys, and other public rights-of-way. The application shall state the species, if ascertainable, and maximum height of the grasses. The application may be made without cost to the applicant. The application shall be granted or granted with reasonable conditions unless it is determined that the granting will conflict with the purpose and intent of this Code, in which event the application will be denied. The denial of an application or the reasonableness of conditions imposed may be appealed to the Board of Housing Appeals in accordance with the procedures of this Code.

CODE OF GENERAL ORDINANCES, 2021 - KENOSHA, WISCONSIN

In the event that the Responsible Person fails to comply with an order of a Code Official to cut grass or trim trees or shrubs, the Code Official shall have the grass cut to a height of three inches (3") and have the trees trimmed and shall recover the cost through special charges levied against the benefited property. A One Hundred Dollar (\$100.00) Administrative Fee for processing and administering the special charge shall be added to the special charge against the benefited property.

H. Firewood Storage. Firewood, for personal use only, may be kept on residentially zoned or used property. It shall be stored in straight, orderly piles which are raised a minimum of six inches (6") off the ground, which are not more than six feet (6') in height, which are not in the "front Yard" as defined in the Zoning Ordinance, and which are no closer than four feet (4') to a Dwelling.

I. Accessory Buildings/Structures. All Accessory Buildings and Structures, including windows and doors which are a part thereof, shall be maintained structurally sound and in Good Repair.-

J. Fences. All fences shall be maintained in Good Repair, be structurally sound and plumb. Fence surfaces shall be free of rust, corrosion, deterioration, decay, missing parts, and peeling, flaking and chipped paint. Wood surfaces other than decay-resistant wood must be protected from the elements and decay by painting or other protective covering or treatment. Fences shall not be of a type prohibited by Section 16.06 of the Zoning Ordinance for the City of Kenosha.

K. Graffiti. In accordance with Section 11.031 of the Code of General Ordinances, the Owner of any Building or Accessory Building shall be responsible for removing all graffiti therefrom within fifteen (15) days from the posting of the property.

In the event that the Owner of any Building or Accessory Structure does not remove the graffiti so ordered by the Code Official, the Code Official may have the graffiti removed or covered and shall recover the cost of said graffiti removal or covering through a special charge levied against the benefited property. A One Hundred Dollar (\$100.00) Administrative Fee shall be added to the special charge against the benefited property.

L. Vehicles, Trailer and Equipment Parking and Storage.

1. The Owner of the Premises is responsible for compliance with Sections 7.128 and 7.129 of the Code of General Ordinances regulating motor vehicles and regulating parking of prohibited motor vehicles.

2. The Owner of a Premises which is zoned and/or used for residential purposes, and which has a principal structure, may not allow parking or storage of motor vehicles, recreational vehicles, truck campers and/or caps, camping trailers or boats within the front yard and street side yard areas as defined by the City of Kenosha Zoning Ordinance, unless on driveway aprons.

3. The Owner of a Premises which is zoned for residential purposes, and which has no principal building erected, may not allow parking or storage of motor vehicles, recreational vehicles, truck campers and/or caps, camping trailers or boats, except for any vehicle that is being used in the lawful construction work being performed pursuant to all required and applicable licenses, permits and approvals.

4. The Owner of a Premises that is located in a Nonresidential Zoning District and that has no principal structure erected on it, may not allow parking or storage of motor vehicles, recreational vehicles, truck campers and/or caps, trailers, or boats except for such use that is authorized by an Occupancy Permit, a Site Plan

CODE OF GENERAL ORDINANCES, 2021 - KENOSHA, WISCONSIN

Approval, a Conditional Use Permit, or a parking lot permit, or that is in the lawful construction work being performed pursuant to all required and applicable licenses, permits and approvals.

16.18 EXTERIOR OF STRUCTURES

The exterior of a Structure shall be maintained by the Responsible Person in accordance with this Section.

A. Exterior Walls, Surfaces and Repairs. All exterior walls and surfaces, including, but not limited to, decorative features and overhang extensions, doors, door and window frames, cornices, porches and trim, shall be maintained in Good Repair. All exterior surfaces shall be free from decay, missing parts, serious cracking, irregularities, and peeling, flaking and chipped paint. Flaking and chipping paint, when removed, shall be collected and stored in containers and disposed of in accordance with Federal and State Law. Exterior wood surfaces, other than decay-resistant woods, shall be protected from the elements and decay by painting or other protective covering or treatment. Peeling, flaking and chipped paint shall be eliminated and affected surfaces treated and repainted in a Workerlike manner. All siding and masonry joints as well as those between the Building envelope and the perimeter of windows, doors, and skylights shall be maintained weather resistant and watertight. All surface repairs shall be completed to closely match the existing surface color and texture.

B. Street Numbers. All street numbering shall be in conformance with the requirements set forth in Section 9.23 of the Code of General Ordinances.

C. Structural Members. All structural members shall be maintained structurally sound, in Good Repair, and be capable of safely supporting the imposed loads.

D. Foundation Walls. All foundation walls shall be maintained structurally sound and free from open cracks and breaks, in Good Repair, and shall be kept in such condition so as to prevent the entry of rodents.

E. Exterior Walls. All exterior walls shall be maintained structurally sound, free from holes, breaks, loose or rotting materials, in Good Repair, and maintained weatherproof. Responsible Persons shall not remove any door or window in a Residential Dwelling, except to board up a door or window not required for Light or Ventilation by removing existing trim, installing framing as necessary and siding to match the existing siding. All repairs shall be completed in a Workerlike manner to match the existing materials, architecture and colors. The Owner is required to obtain the approval of the Code Official for methods used to board up any windows or doors in Commercial, manufacturing or industrial Buildings.

F. Roofs and Drainage. The roof and flashing shall be maintained structurally sound, tight and not have defects that admit water. The Roof Coverings shall be in Good Repair and free from missing components. All repairs shall be made to Closely match the type and color of the existing roof. Roof drains, gutters and downspouts shall be maintained in Good Repair and free from obstructions. Roof water shall not discharge in a manner that degrades the integrity of a Structure.

G. Decorative Features. All cornices, belt courses, corbels, terra cotta trim, wall facings and similar decorative features shall be maintained in Good Repair with proper anchorage and in a safe condition. Any missing parts shall be replaced with matching parts.

H. Overhang Extensions. All canopies, marquees, signs, metal awnings, fire escapes, standpipes, exhaust ducts and similar overhang extensions shall be maintained structurally sound and in Good Repair with proper anchorage.

CODE OF GENERAL ORDINANCES, 2021 - KENOSHA, WISCONSIN

I. Stairways, Decks, Porches, Ramps and Balconies. Every exterior stairway, deck, porch, ramp, and balcony, and all appurtenances attached thereto, shall be maintained structurally sound, in Good Repair, with proper anchorage and capable of supporting the imposed loads. Any new or replacement stairways, decks, porches, ramps and balconies shall be installed in accordance with the requirements of the Wisconsin Administrative Code SPS Chapters 321 and 361.

J. Handrails/Guardrails.

1. Requirements. Every stairway, deck, porch, ramp and balcony with more than three (3) risers or where more than twenty-four inches (24") above grade, shall have handrails/guardrails installed which are in Good Repair. Good Repair shall mean structurally sound, with proper anchorage, and capable of supporting projected loads.

2. Maintenance. Every handrail/guardrail shall be maintained so as to be in Good Repair.

3. Standards For Handrails. Handrails shall be installed in accordance with the standards set in the Wisconsin Administrative Code SPS 321.04 as below:

a. One-Family and Two-Family Dwelling Units: Thirty inch (30") minimum height; thirty-eight inch (38) maximum height.

b. Multi-Family Dwellings of Three (3) or more Units: Thirty-four inch (34") minimum height; thirty-eight inch (38") maximum height.

c. Handrails shall have intermediate rails on open-sided floor areas. The rails shall be balusters or be of solid material such that a sphere with a diameter of four (4") inches cannot pass through any opening. Plywood and latticework are not permitted in replacement or new intermediate rails. This standard shall not apply to intermediate rails installed prior to 2005 that are in Good Repair, and that have balusters or are of a solid material such that a sphere with a diameter of six (6") inches cannot pass through any opening.

4. Standards For Guardrails. Guardrails shall be installed in accordance with the standards set in the Wisconsin Administrative Code SPS 321.04 as below:

a. One-Family and Two-Family Dwelling Units: No less than thirty-six inches (36") in height.

b. Multi-Family Dwellings of Three (3) or more Units: No less than forty-two inches (42") in height.

c. Guardrails shall be measured vertically above the leading edge of the tread or adjacent walking surface.

d. Guardrails shall have intermediate rails on open-sided floor areas. The rails shall be balusters or be of solid material such that a sphere with a diameter of four inches (4") cannot pass through any opening. Plywood and latticework are not permitted in replacement or new intermediate rails. This standard shall not apply to intermediate rails installed prior to 2005 that are in Good Repair, and that have balusters or are of a solid material such that a sphere with a diameter of six inches (6") cannot pass through any opening.

K. Chimneys, Towers and Antennas. All chimneys, cooling towers, smokestacks and similar appurtenances shall be maintained structurally safe and sound, and in Good Repair. All exposed surfaces of metal or wood shall be protected from the elements and against decay or rust by periodic application of weather-coating materials, such as paint or similar surface treatment.

L. Windows. Every window, storm window, skylight and screen window, including the frames shall be kept in sound condition, Good Repair and weathertight.

1. Glazing. All window glazing materials shall be maintained free from cracks and holes.

CODE OF GENERAL ORDINANCES, 2021 - KENOSHA, WISCONSIN

2. Openable Windows. Every window, other than a fixed window, shall be easily openable, capable of being held in position by existing window hardware, and have locking devices in Good Repair and good working order.

3. Insect Screens. During the period from April 15 to October 15, every openable window, every door and other outside openings required for Ventilation of habitable rooms, food preparation areas, food service areas, and any area where products to be included or used in food for human consumption are processed, manufactured, packaged or stored, shall be supplied with tightly fitting screens of not less than sixteen (16) mesh per square inch and every swinging door shall have a self-closing device in Good Repair and Good Working Condition. The use of half screens or interior type temporary screens is prohibited.

4. Storm Windows. All exterior windows shall have storm windows installed and maintained to prevent excessive drafts and heat loss no earlier than October 15, but no later than November 15, annually, except where permanent and openable or where the prime sash is a double or triple-glazed sash.

M. Doors. All exterior doors, door assemblies and hardware shall be maintained in Good Working Condition and in Good Repair.

1. Door Viewer. Each main entrance door into a Dwelling and Dwelling Unit shall contain an approved door viewer, except where a window in the door, or a window adjacent to the doorway, provides a clear view of the entrance.

2. Door Type and Hinges. Doors leading into each Dwelling and Dwelling Unit shall be of solid-core type or insulated steel construction, equipped with door hinges so arranged as to be inside the Dwelling or Dwelling Unit or with locking pin hinges.

3. Deadbolt Locks. All doors leading into each Dwelling and Dwelling Unit shall have a keyed deadbolt lock with a minimum one inch (1") throw, which is operable with a key on the exterior side of the door and a knob on the interior side of the door. The deadbolt strikeplate shall be held in place by no less than two and one-half (2-1/2") inch screws. Sliding patio doors shall have an approved secondary locking device; e.g., locking pins or 2 x 4's of proper length. Deadbolt locks shall be in Good Working Condition and Good Repair.

4. Egress. From a Structure or Dwelling Unit, all means of egress shall be readily openable from the side from which egress is to be made without the need for keys, special knowledge or effort except in institutional settings with prior approval of the Code Official.

N. Security Maintenance. All Building security locks and related intercom communication systems shall be maintained and kept in Good Working Condition and Good Repair.

O. Basement Hatchways. Every Basement hatchway shall be maintained to prevent the entrance of rodents, rain and surface drainage water, in Good Repair and in Good Working Condition.

P. Basement Windows. Every Basement window shall provide protection against the entry of rodents, be in Good Working Condition and be in Good Repair.

16.19 INTERIOR OF RESIDENTIAL UNITS

The interior of a Structure and appliances therein which were Provided by the Responsible Person shall be maintained by the Responsible Person in compliance with this Section.

CODE OF GENERAL ORDINANCES, 2021 - KENOSHA, WISCONSIN

A. Interior Wall, Ceiling and Floor Surfaces and Repairs. All interior wall, ceiling and floor surfaces, including, but not limited to, windows and doors, shall be maintained in Good Repair. All surfaces shall be free from serious cracking, irregularities and peeling, flaking and chipped paint. All surface repairs shall be completed to closely match the existing surface color and texture. Floor surfacing shall provide ease of maintenance and durability appropriate for the use of the room.

B. Structural Members. All structural members shall be maintained structurally sound, in Good Repair, and be capable of supporting the imposed loads.

C. Bathroom Floors, Walls and Ceiling. Every Bathroom floor, wall and ceiling surface shall be properly constructed and maintained so as to be reasonably impervious to water and so as to permit such surfaces to be easily kept in a clean and sanitary condition.

D. Stairs and Walking Surfaces. All interior stairs, ramps, balconies, porches, decks and other walking surfaces shall be maintained in a structurally sound condition, in Good Repair, with proper anchorage and capable of supporting the imposed loads. Stairways shall comply with the Wisconsin Administrative Code SPS 321.04.

E. Handrails and Guardrails. Every handrail and guardrail shall be maintained structurally sound, in Good Repair, with proper anchorage and capable of supporting the imposed loads. Handrails and guardrails shall comply with the Wisconsin Administrative Code SPS 321.04.

F. Interior Doors. Every interior door shall fit reasonably well within its frame and shall be capable of being opened and closed by being properly and securely attached to jambs, headers or tracks as intended by the manufacturer of the attachment hardware.

G. Facility, Cabinet, Equipment, Appliance and Utility Installation and Maintenance. Every facility, cabinet, piece of equipment, appliance and utility shall be so constructed, installed and maintained so that it will be in Good Repair and in a Good Working Condition. Any facility, cabinet, piece of equipment or appliance not in Good Working Condition, which is supplied by the Responsible Person, shall be repaired or removed by the Responsible Person. It shall be the responsibility of the Tenant or Occupant to maintain supplied facilities, cabinets, equipment, appliances and utilities, in a clean and sanitary condition when contained within the Tenant's/Occupant's Dwelling Unit.

H. Sanitary Conditions. The Responsible Person shall maintain the common areas of their Premises in a clean, safe and sanitary condition. Occupants (including Owner Occupants and Tenants) of a Premises shall be responsible for caring for and maintaining in a clean, safe, and sanitary condition that part of the Premises which they occupy and control.

16.20 WASTE COLLECTION AND REMOVAL AND RECYCLING

A. General.

1. Every exterior Premises shall be maintained to be free from any accumulation of Garbage and Debris.
2. A Garbage contained in a container or dumpster pursuant to subparagraph 16.20 B.2 f. and/or incorporated in a compost pile approved by the Code Official or his/her designee, is exempt from this requirement.

B. Disposal. The Responsible Person for every Premises shall be responsible for the temporary storage

CODE OF GENERAL ORDINANCES, 2021 - KENOSHA, WISCONSIN

of Garbage and Debris and the removal.

1. Residential and Commercial Premises - Responsibility. The Responsible Person shall provide and maintain Garbage and Debris containers with tight fitting lids on both Residential and non-residential properties for the collection of Garbage and Debris until removed from the Premises for disposal.

2. Garbage Containers and Dumpsters.

a. Garbage containers and dumpsters shall be of a number and size to adequately handle the waste generated by the Occupants.

b. The Responsible Person shall be responsible for preventing or correcting any overflow of waste from the waste containers or dumpsters.

c. All dumpsters shall be placed on a paved or hard packed surface.

d. Enclosures required by a City Conditional Use Permit or Site Plan Review for waste containers and dumpsters shall be installed and maintained in accordance with approved plans.

e. Garbage containers and dumpsters shall be maintained in Good Repair.

f. Garbage containers and dumpsters, except for the day of collection, shall be stored every day, at any location on private property which is enclosed, or stored in a Dwelling or Structure, or located in the rear or side Yard for the Dwelling or Structure.

16.21 INFESTATION AND EXTERMINATION

A. Infestation. All Structures shall be kept free from Infestation. All Structures with Infestation shall have the Infestation exterminated by approved processes that will not be injurious to human health. After Extermination, proper precautions shall be taken to prevent reinfestation.

B. Responsibility for Extermination. The Responsible Person for any Structure shall be responsible for Extermination.

C. Extermination. If Extermination is ordered by the Code Official, or his/her designee, Extermination shall be performed by a State of Wisconsin licensed exterminator. Effective Extermination shall continue until the Infestation is eliminated. The Responsible Person shall submit completed Extermination reports from the licensed exterminator to the Code Official.

16.22 LIGHT, VENTILATION AND OCCUPANCY LIMITATIONS

A. General.

1. Scope. The provisions of this Section shall provide the minimum requirements and standards for Light, Ventilation and Occupancy limitations for Structures.

2. Responsibility. The Responsible Person shall provide and maintain Light, Ventilation and Occupancy limitations in compliance with this Section.

3. Prohibition. A Person shall not occupy, or permit another Person to occupy any Structure that does not comply with the requirements of this Section.

4. Alternative Devices. In lieu of the means for natural Light and Ventilation herein prescribed, artificial Light or mechanical Ventilation complying with the City Building Code shall be permitted.

CODE OF GENERAL ORDINANCES, 2021 - KENOSHA, WISCONSIN

B. Light.

1. Habitable Spaces. Every Habitable Space shall have at least one (1) window of a size required by the Wisconsin Administrative Code Chapters SPS 320-325 facing directly to the outdoors or to a court. The minimum total window pane areas for every Habitable Space shall be eight percent (8%) of the floor area of such room. Wherever walls or other portions of a Structure face a window of any room and such obstructions are located less than three feet (3') from the window and extend to a level above that of the ceiling of the room, such window shall not be deemed to face directly to the outdoors nor to a court, and shall not be included as contributing to the required minimum total window area for the room. Where natural Light for rooms or spaces without exterior window pane areas is Provided through an adjoining room, the unobstructed opening to the adjoining room shall be at least eight percent (8%) of the floor area of the interior room or space, but not less than twenty-five square feet (25ft²). The exterior window pane area shall be based on the total floor area being served.

2. Common Hall and Stairway Spaces.

a. Two to Four Family Dwellings: Public pathways and stairways in Buildings accommodating 2, 3 or 4 families shall be Provided with convenient Light switches controlling a system for adequate lighting, which may be turned on when needed.

b. Five or More Families. Public pathways and stairways in Buildings accommodating more than 4 families, accommodating more than 30 Persons, or accommodating transients shall be lighted at all times with adequate Light.

c. Where one or more lighting fixtures(s) are installed for interior stairways, there shall be a wall switch at each floor level, and landing level that includes an entryway, to control the lighting outlet(s) where the stairway between floor levels has six risers or more. An exception is allowed in hallways, in stairways and at outdoor entrances, remote, central or automatic control of lighting shall be permitted.

3. Adequate lighting for safe movement through the Basement shall be Provided with a Light switch at the main entrance.

4. Other Spaces. For attics, underfloor spaces, utility rooms, and Basements, at least one lighting fixture containing a switch or controlled by a wall switch shall be installed where these spaces are used for storage or contain equipment which may require periodic servicing. At least one point of control shall be a wall switch at the usual point of entry to these spaces. Lighting shall be Provided at or near equipment which may require periodic servicing.

C. Ventilation.

1. Habitable Spaces. Every Habitable Space shall have at least one (1) operable window. The total Openable Area of the window in every room shall be equal to at least forty-five percent (45%) of the minimum window paned area required in this Code.

Where rooms and spaces without openings to the outdoors are ventilated through an adjoining room, the unobstructed opening to the adjoining room shall be at least eight percent (8%) of the floor area of the interior room or space, but not less than twenty-five square feet (25 ft²). The Ventilation openings to the outdoors shall be based on a total floor area being ventilated.

2. Bathrooms. Every Bathroom shall comply with the Ventilation requirements for Habitable Spaces as required by this Code, except that a window shall not be required in such spaces as are equipped with a mechanical Ventilation system. Air exhausted by a mechanical Ventilation system from a Bathroom shall

CODE OF GENERAL ORDINANCES, 2021 - KENOSHA, WISCONSIN

discharge directly to the outdoors and shall not be recirculated.

3. Clothes Dryer Venting Systems. Clothes dryer venting systems shall be independent of all other systems and shall be vented directly outside or in accordance with the manufacturer's instructions.

D. Occupancy Limitations.

1. Privacy. Dwelling Units and rooming units of Lodging Houses shall be arranged to provide privacy and be separate from other adjoining spaces.

2. Minimum Room Widths. A habitable room, other than a kitchen, shall not be less than seven feet (7') in length or width. Kitchens shall have a clear passageway of not less than three feet (3') between counter fronts and appliances or counter fronts and walls.

3. Minimum Ceiling Heights. Habitable spaces, hallways, corridors, laundry areas, Bathrooms, toilet rooms and habitable Basement areas shall have a clear ceiling height of not less than seven feet (7'). Rooms occupied exclusively for sleeping, study or similar purposes may have a sloped ceiling over all or part of the room, with a clear ceiling height of at least seven feet (7') over not less than one-third (1/3) of the required minimum floor area. In calculating the floor area of such rooms, only those portions of the floor area with a clear ceiling height of five feet (5') or more shall be included.

4. Bedroom Requirements. Every Bedroom shall comply with the following requirements:

a. Area For Sleeping Purposes. Every Bedroom occupied by one (1) Occupant shall contain at least seventy square feet (70 ft²) of floor area, and every Bedroom occupied by more than one (1) Occupant shall contain at least fifty square feet (50 ft²) of floor area for each Occupant thereof.

b. Access From Bedrooms. Bedrooms, except for in Dwelling Units that contain only one Bedroom, shall not constitute the only means of access to other Bedrooms or Habitable Spaces and shall not serve as the only means of egress from other Habitable Spaces.

c. Bathroom Accessibility. Every Bedroom shall have access to at least one (1) Bathroom without passing through another Bedroom. Every Bedroom in a Dwelling Unit shall have access to at least one (1) Bathroom located in the same story as the Bedroom or an adjacent story.

d. Kitchens and Nonhabitable Spaces. Kitchens and nonhabitable spaces shall not be used for sleeping purposes.

e. Basement Bedrooms. No Basement space shall be used as a Bedroom unless:

(1) The floor and walls are impervious to leakage of underground and surface runoff water and are insulated against dampness.

(2) The total windowpane area in each room that is capable of admitting natural Light must be at least the area required in paragraph 16.22 B.1.

(3) The total of openable window area in each room must be at least the minimum required in paragraph 16.22 C.1, except where there is supplied some other device affording adequate Ventilation and approved by the Code Official.

(4) The room meets all the requirements of this Code and the requirements of the Wisconsin Administrative Code Chapters SPS 20-25, specifically including egress window requirements.

5. Minimum Area Requirements. Dwelling Units shall not be occupied by more Occupants than permitted by the minimum area requirements specified in the following **Table 16.22 D.5**.

CODE OF GENERAL ORDINANCES, 2021 - KENOSHA, WISCONSIN

MINIMUM AREA REQUIREMENTS
TABLE 16.22 D

MINIMUM AREA IN SQUARE FEET			
SPACE	1 - 2 Occupants	3 - 5 Occupants	6 or More Occupants
Living Room	No Requirements	120 s.f.	150 s.f.
Dining Room	No Requirements	80 s.f.	100 s.f.
Kitchen	50 s.f.	50 s.f.	60 s.f.
Bedrooms	70 s.f. for 1 Person; 50 s.f. for each Person where more than 1 Person		

a. Sleeping Area. The minimum Occupancy area required by Table 16.22 D.5. shall not be included as a sleeping area in determining the minimum Occupancy area for sleeping purposes.

b. Combined Spaces. Combined living room and dining room spaces shall comply with the requirements of **Table 16.22 D.5.** if the total area is equal to that required for separate rooms and if the space is located so as to function as a combination living room/dining room.

6. Efficiency Unit. Nothing in this Section shall prohibit the use of an Efficiency Dwelling Unit meeting the following requirements:

a. An Efficiency Dwelling Unit occupied by not more than two (2) Occupants shall have a clear floor area of not less than two hundred twenty square feet (220 ft²). An Efficiency Dwelling Unit occupied by three (3) Occupants shall have a clear floor area of not less than three hundred twenty square feet (320 ft²). These required areas shall be exclusive of the areas required by subparagraphs **b.** and **c.**;

b. having a kitchen sink, space and hookups for cooking appliances and refrigeration facilities, each having a clear working space of not less than thirty inches (30") in front. Light and Ventilation conforming to this Code shall be Provided;

c. having a separate Bathroom containing a toilet, lavatory, and bathtub or shower; and

d. having no more than three (3) Occupants.

16.23 PLUMBING SYSTEMS FACILITIES AND FIXTURE REQUIREMENTS

A. General.

1. Responsibility. The Responsible Person of the Structure shall provide and maintain plumbing systems facilities, and fixtures in compliance with this Section.

2. Prohibition. A Person shall not occupy or permit another Person to occupy any Structure that does not comply with the requirements of this Section.

3. Maintaining Sanitary Sewer and Water Service. No Responsible Person may cause any sanitary sewer or water service to be removed from or shut off from or discontinued for any occupied Dwelling, Dwelling Unit or Lodging Room, except for such temporary interruption as may be necessary while actual repairs are in process, or during temporary emergencies beyond the control of the Responsible Person.

4. Maintaining Fixtures. Every Occupant of a Dwelling Unit shall keep all plumbing fixtures therein in a clean and sanitary condition and shall be responsible for the exercise of reasonable care in the proper use and operation thereof.

CODE OF GENERAL ORDINANCES, 2021 - KENOSHA, WISCONSIN

B. Required Facilities.

1. Dwelling Units. Every Dwelling Unit shall contain its own bathtub or shower, Bathroom sink and kitchen sink which shall be maintained by the Responsible Person in Good Repair, in Good Working Condition, and in a sanitary condition. The Bathroom sink shall be placed in the same room as the water Closet or located in Close proximity to the door leading directly into the room in which such water Closet is located. A kitchen sink may not be used as a substitute for the required Bathroom sink.

2. Privacy. Toilet rooms and Bathrooms shall provide privacy and shall not constitute the only passageway to a hall or other space, or to the exterior. A door and interior locking device shall be Provided for all Bathrooms and toilet rooms.

C. Plumbing Systems and Fixtures.

1. Fixtures. Fixtures shall be properly installed in Good Repair, in Good Working Condition, and shall be kept free from obstructions, leaks and defects and be capable of performing the function for which such plumbing fixtures are designed.

2. Plumbing System Hazards. Plumbing systems shall be properly installed in Good Repair, in Good Working Condition and shall be kept free from obstructions, leaks and defects and be capable of performing the function for which designed. The plumbing system in a Structure shall not constitute a hazard to the Occupants or the Structure by reason of inadequate service, inadequate venting, cross-connection, backsiphonage, improper installation, deterioration or damage or for similar reasons.

D. Water Supply System.

1. Water Supply Source. Every sink, lavatory, bathtub or shower, toilet, drinking fountain, laundry facility or other plumbing fixture shall be properly connected to either a public water supply system or to a State or City approved private water system and shall be supplied with hot or tempered and cold running water in accordance with the State Plumbing Code.

2. Free From Contamination. The water supply shall be maintained free from contamination, and all water inlets for plumbing fixtures shall be located above the flood level rim of the fixture. Shampoo basin faucets, janitor sink faucets, and other hose bibs or faucets to which hoses are attached and left in place, shall be protected by an approved atmospheric type vacuum breaker or an approved permanently attached hose connection vacuum breaker.

3. Adequate Supply. The water supply system shall be installed and maintained to provide a supply of water to plumbing fixtures, devices and appurtenances in sufficient volume and at pressures adequate to enable the fixtures to function properly, safely, and free from defects and leaks.

4. Water Heating Facilities. Every Dwelling Unit shall have water heating facilities properly installed in Good Repair, Good Working Condition, and maintained and capable of providing an adequate amount of water to be drawn at every required sink, lavatory, bathtub, shower, toilet and laundry facility at a temperature of not less than 110°F (43°C). A gas-burning water heater may not be located in any Bathroom, toilet room, Bedroom or other occupied room normally kept closed, unless adequate combustion air is Provided. An approved combination temperature and pressure relief valve and relief valve discharge pipe shall be properly installed and maintained on water heaters.

CODE OF GENERAL ORDINANCES, 2021 - KENOSHA, WISCONSIN

E. Sanitary Sewer and Treatment System.

1. System Connection. All plumbing fixtures shall be properly connected to either a public sewer and treatment system or to a State or City approved private sewage treatment system.

2. Maintenance. Every plumbing stack, vent, waste and sewer line shall be maintained in Good Repair, Good Working Condition and function as designed and be kept free from obstructions and leaks.

16.24 MECHANICAL AND ELECTRICAL FACILITIES AND EQUIPMENT

A. General.

1. Responsibility. The Responsible Person of the Structure shall provide and maintain mechanical and electrical facilities and equipment in compliance with this Section.

2. Prohibition. A Person shall not occupy or permit another Person to occupy any Structure that does not comply with the requirements of this Code. No Responsible Person shall cause any mechanical or electrical service, facility or equipment which is required under this Code to be removed from, shut off from or discontinued from any occupied Dwelling, Dwelling Unit or Lodging Room rented or occupied by him/her, except for temporary interruption as may be necessary while actual repairs are in process, or during such temporary emergencies when discontinuance of service is approved by the Code Official.

B. Heating Facilities and Equipment.

1. Facilities and Equipment Required. Heating facilities and equipment shall be Provided in Structures as required by this Section.

2. Residential Occupancies. Dwellings and Dwelling Units shall be Provided with heating facilities and equipment capable of maintaining a room temperature of 68°F in all habitable rooms, Bathrooms and toilet rooms when the outside temperature is at or above 0°F and 60°F when the outside temperature is below 0°F.

3. Heat Supply. Every Responsible Person for any Structure who Rents one (1) or more Dwelling Units, either expressed or implied, shall furnish to the Occupants thereof, a permanently attached heating system capable of maintaining a temperature of not less than 68°F in all habitable rooms and Bathrooms when the outside temperature is at or above 0°F and not less than 60°F when the outside temperature is below 0°F. Unless the lease provides otherwise, the Owner of the property is responsible to provide heat. Portable space heaters may not be used as the main heat supply. Underwriters' Laboratories listed portable space heaters may be permitted as a temporary source of heat only while the main heat supply is being repaired.

4. Central Heating System Requirements. Every central heating system shall comply with the Wisconsin Administrative Code Chapters SPS 323, 363 and 364 when applicable. It shall also comply with the following requirements:

a. The central heating system shall be in Good Repair and Good Working Condition.

b. Every heat duct, steampipe and hot water pipe shall be free of leaks and shall function so that an adequate amount of heat is delivered where intended.

CODE OF GENERAL ORDINANCES, 2021 - KENOSHA, WISCONSIN

c. Every seal between the sections of a warm air furnace shall be tight, so noxious gases will not escape into heat ducts.

5. Permanently Attached Space Heaters. Every permanently attached space heater shall comply with the Wisconsin Administrative Code Chapters SPS 323, 363 and 364, when applicable, and with all of the following requirements:

a. No space heater burning solid, liquid or gaseous fuels shall be a portable type.

b. Every space heater burning solid, liquid or gaseous fuels shall be properly vented in accordance with manufacturer's instructions.

c. Every coal burning or oil burning space heater shall have a fire resistant panel beneath it.

d. The location of space heaters, the insulation of walls and ceilings close to such heaters and the construction, installation and guarding of smokepipes and walls or ceilings through which they go shall meet the requirements of applicable State Law and City Ordinances.

C. Fuel Burning Appliances.

1. Definition. Fuel Burning Appliances shall mean and include nonelectrical stoves and food preparation devices, water heaters and fireplaces, and all components and accessories therefor, which burn natural gas, LP gas, wood or other combustible materials.

2. Installation and Maintenance. All fuel-burning appliances shall be properly installed and maintained in Good Repair, in Good Working Condition, and shall be capable of performing the intended function.

3. Prohibited Use. Cooking appliances shall not be used to meet the heating requirements of this Code.

4. Venting. All fuel burning appliances shall be connected to an approved chimney or vent, except for appliances which are approved by the manufacturer for unvented operation.

5. Clearances. All manufacturer required clearances for fuel burning appliances shall be maintained.

6. Safety Controls. All safety controls for fuel burning appliances shall be maintained in Good Repair, Good Working Condition and be capable of performing the intended function.

7. Combustion Air. A supply of air for complete combustion of the fuel and for Ventilation of the space containing the fuel burning appliance shall be Provided.

8. Energy Conservation Devices. Devices intended to reduce fuel consumption by attachment to a fuel-burning appliance, to the fuel supply line thereto, or to the vent outlet or vent piping therefrom, shall not be installed unless labeled by the manufacturer for such purpose and the installation is specifically approved by the manufacturer.

D. Electrical Facilities.

1. Facilities Required. Every occupied Structure shall be Provided with an electrical system in compliance with the requirements of this Section.

CODE OF GENERAL ORDINANCES, 2021 - KENOSHA, WISCONSIN

2. Service. Every Dwelling and Dwelling Unit shall be served by a main service that is not less than sixty (60) amperes, three (3) wires and protected with fuses or circuit breakers.

3. Electrical System Hazards. Where it is found that the electrical system in a Structure constitutes a hazard to the Occupants or the Structure by reason of inadequate service, improper fusing, insufficient outlets, improper wiring or installation, deterioration or damage, or for similar reasons, the Code Official shall require the defects to be corrected to eliminate the hazard.

E. Electrical Equipment. All electrical equipment, wiring and appliances shall be properly installed and maintained in Good Repair, in Good Working Condition and be capable of performing the intended function.

16.25 FIRE SAFETY REQUIREMENTS

A. General.

1. Scope. The provisions of this Section shall provide the minimum requirements and standards for fire safety relating to Structures and Premises, including fire safety facilities and equipment to be Provided.

2. Enforcement.

a. Code Official. The Code Official shall be responsible for enforcing the requirements of this Code in one and two-family Dwellings and in the individual units located in multifamily units containing three (3) or more units.

b. Fire Prevention Bureau. The Fire Prevention Bureau shall be responsible for enforcing the City's fire safety requirements in accordance with Chapter 3 of the Code of General Ordinances.

3. Responsibility. The Responsible Person of the Premises shall provide and maintain fire safety facilities and equipment in compliance with this Section.

4. Prohibition. A Person shall not occupy or permit another Person to occupy any Premises that does not comply with the requirements of this Section.

B. Means Of Egress.

1. Number of Exits. Every Dwelling, Dwelling unit and Lodging Room shall have direct access to at least two (2) accessible unobstructed means of egress or stairways above the first floor, one of which must lead to an open public street, alley, or court connected to a street.

2. Types of Egress. Exterior stairways, Egress Windows or exit platforms, or a combination thereof, will be permitted as second exits for Dwellings and Dwelling Units constructed prior to January 1, 1985 (date of modification to the Wisconsin Administrative Code Chapters SPS 320-325) if approved by the Code Official. Platforms or stairways shall terminate at a point not more than ten feet (10') above the grade directly below the lowest platform for Buildings containing three (3) or more units and fifteen feet (15') above the grade directly below the lowest platform for one (1) and two (2) unit Dwellings. Platforms shall have a minimum size of three feet (3') by four feet (4'). All stairways and platforms shall be protected with handrails and guardrails as specified in the Wisconsin Administrative Code. Egress exits not meeting the above criteria may be approved by the Code Official.

CODE OF GENERAL ORDINANCES, 2021 - KENOSHA, WISCONSIN

3. Exit Capacity. The capacity of the exits serving a floor shall be sufficient for the Occupant load thereof as determined by the Wisconsin Administrative Code Chapters SPS 320-325 and 350-364.

4. Arrangement. Exits from Dwellings, Dwelling Units, and lodging units shall not lead through other such units, or through Bathrooms.

5. Security. Bars, grilles or screens placed over emergency escape windows shall be releasable or removable from the inside without the use of a key, tool or force greater than that which is required for normal operation of the window.

C. Unobstructed Passageways.

1. Stairways, passageways, doors, windows, fire escapes or other means of egress shall be kept open and unobstructed. Exterior exits shall be unobstructed.

2. Hazardous Material. Combustible, flammable, explosive or other hazardous materials, such as paints, volatile oils and cleaning fluids, or combustible rubbish, such as wastepaper, boxes and rags, shall not be accumulated or stored unless such storage complies with the applicable requirements of the Building Code and the Fire Prevention Code.

D. Fuel Oil Tanks. Abandoned fuel oil tanks shall be referred to the Fire Prevention Bureau for review and disposition.

E. Fire Doors. All required fire doors shall be maintained in good working order, including all hardware necessary for the proper operation thereof. Fire doors shall not be held open by door stops, wedges and other unapproved hold-open devices.

F. Fire Protection Systems.

1. Smoke Detectors. The Responsible Person of a Dwelling, Dwelling Unit and Lodging Room shall install a functional Smoke Detector as follows:

a. One and Two Family Dwellings Constructed Prior to June 1, 1980.

(1) In the Basement of the Dwelling.

(2) On each floor, except the attic or storage area of each Dwelling Unit.

b. One and Two Family Dwellings Constructed After June 1, 1980.

(1) In the Basement.

(2) On each floor level, except the attic or storage area of each Dwelling Unit.

(3) For floor levels containing a sleeping area, Smoke Detectors shall be installed adjacent to the sleeping area. If a floor level contains two (2) or more sleeping areas remote from each other, each sleeping area shall be Provided with an adjacent Smoke Detector.

(4) Smoke detectors shall be continuously powered by the electrical service in the Dwelling and shall be interconnected.

(5) For family Dwelling Units with split levels or open adjacent levels with less than one (1) full story separation between levels, one (1) Smoke Detector on the upper level shall suffice for an adjacent lower level, including Basements.

c. Apartment Buildings, Condominiums, Townhouses Exceeding Sixty (60) Feet (or Six Stories), and All Lodging Houses.

CODE OF GENERAL ORDINANCES, 2021 - KENOSHA, WISCONSIN

(1) In the Basement.

(2) At the head of every open stairway.

(3) At the door on each floor level leading to every enclosed stairway.

(4) Either in each sleeping area of each Dwelling Unit or elsewhere in the unit within six (6') feet of each sleeping area and not within a kitchen.

(5) All Smoke Detectors in stairways, corridors and other public places in the Building shall be directly and permanently wired to a proper unswitched circuit.

d. Multifamily Dwelling Constructed After April 1, 1995; Additions to Multifamily Dwelling Constructed After April 1, 1995; Conversion to Multifamily Dwelling After April 1, 1995.

(1) In the Basement.

(2) At the head of every open stairway.

(3) At the door on each floor level leading to every enclosed stairway.

(4) Either in each sleeping area of each Dwelling Unit or elsewhere in the Unit within six (6') feet of each sleeping area, but not within a kitchen.

(5) All Smoke Detectors shall be directly and permanently wired to a proper unswitched circuit and be Provided with a backup source of power.

e. Installation. All Smoke Detectors shall be installed in accordance with the Building Code and the manufacturer's instruction. When actuated, the smoke detectors shall provide an alarm suitable to warn the occupants within the individual room or dwelling unit.

f. Tampering Prohibited. It shall be a violation of this Code for any Person to remove or tamper with the Smoke Detector.

g. Maintenance. The Responsible Person shall maintain all Smoke Detectors in the common areas of all Residential Buildings. The Occupant of a Dwelling or Dwelling Unit shall maintain any Smoke Detector in that Dwelling or Dwelling Unit, except that if any Occupant who is not the Responsible Person, or a State, County, City, Village or Town officer, agent or employee charged under State Statute or municipal ordinance with powers or duties involving inspection of real or personal property, gives written notice to the Responsible Person that the Smoke Detector is not functional, the Responsible Person shall provide within twenty-four (24) hours after receipt of that notice, any maintenance necessary to make that Smoke Detector functional.

2. Carbon Monoxide Detectors

A. Installation

1. The Responsible Person shall install a minimum of one carbon monoxide detector in a single family Building.

2. The Responsible Person shall install a carbon monoxide detector in all of the following places:

a. In the Basement of the Building if the Basement has a fuel-burning appliance.

b. Within 15 feet of each sleeping area of a unit that has a fuel-bring appliance.

c. Within 15 feet of each sleeping area of a unit that is immediately adjacent to a unit that has a fuel-burning appliance.

d. In each room that has a fuel-burning appliance and that is not used as a sleeping area, a carbon monoxide detector shall be installed under this subdivision not more than 75 feet from the fuel-burning appliance.

e. In each hallway leading from a unit that has a fuel-burning appliance, in a location that is within 75 feet from the unit, except that, if there is no electrical outlet within this distance, the Responsible Person shall lace the carbon monoxide detector at the Closest available electrical outlet in the hallway.

CODE OF GENERAL ORDINANCES, 2021 - KENOSHA, WISCONSIN

3. Any carbon monoxide detector that bears an Underwriters Laboratories, Inc., listing mark or similar mark from an independent product safety certification organization satisfies the requirement of this subsection.

4. The Responsible Person shall install every carbon monoxide detector required by this subsection according to the directions and specifications of the manufacturer of carbon monoxide detectors.

B. Maintenance Requirements

1. The Responsible Person of a Residential Building shall reasonably maintain every carbon monoxide detector in the Residential Building in the manner specified in the instructions for the carbon monoxide detector.

2. An Occupant of a unit in a Residential Building may give the Responsible Person of the Residential Building written notice that a carbon monoxide detector in the Residential Building is not functional or has been removed by a Person other than the Occupant. The Responsible Person of the Residential Building shall repair or replace the nonfunctional or missing carbon monoxide detector within 5 days after receipt of the notice.

3. The Responsible Person of a Residential Building is not liable for damages resulting from any of the following:

a. A false alarm from a carbon monoxide detector if the carbon monoxide detector was reasonably maintained by the Responsible Person of the Residential Building.

b. The failure of a carbon monoxide detector to operate properly if that failure was the result of tampering with, or removal or destruction of, the carbon monoxide detector by a Person other than the Responsible Person or the result of a faulty detector that was reasonably maintained by the Owner as required under par. A.

4. **Tampering Prohibited.** No Person may tamper with, remove, destroy, disconnect, or remove batteries from an installed carbon monoxide detector, except in the course of inspection, maintenance, or replacement of the detector.

5. **Exceptions.** Carbon Monoxide detectors are not required if the Residential Building does not have an attached garage and any of the following applies:

a. The Residential Building does not have any fuel-burning appliances.

b. All of the fuel-burning appliances in the Residential Building have sealed combustion units that are covered by the manufacturer's warranty against defects.

16.251 REINSPECTION FEES

To compensate the City for inspection and administrative costs related to the enforcement of this Chapter, an escalating fee established by the Common Council through Resolution may be charged for any reinspection following the initial inspection which resulted in an order for corrective action and subsequent reinspections resulting in noncompliance with an order for corrective action issued hereunder. There shall be no reinspection fee for a final inspection indicating compliance or for a reinspection occurring during the period of an approved time extension granted for good cause and involving a good faith effort on the part of the property Owner to comply with the order. Reinspection fees which are not paid by or on behalf of the property Owner within thirty (30) days of mailing of an invoice to the property Owner of record on the City tax roll shall be charged and collected as a special charge against the real estate upon which the

CODE OF GENERAL ORDINANCES, 2021 - KENOSHA, WISCONSIN

reinspections were made, and shall be a lien upon the real estate until paid in full, with interest accruing on the unpaid balance at the rate of seven (7) percent per annum or any other applicable statutory rate, whichever is greater. There shall also be a One Hundred Dollar (\$100.00) administrative charge added to the fee and special charge to cover the administrative costs of charging and specially charging the property.

16.26 PENALTIES

A. Violation Penalties. Any Person who shall violate a provision of this Code, shall, upon conviction, be subject to a forfeiture of not more than One Thousand Dollars (\$1,000.00), and in addition, shall pay the costs and expenses of prosecution. Each day such violation continues shall be considered a separate offense. Failure to promptly pay said forfeiture shall subject the violator to be sentenced to the County Jail for a period not to exceed sixty (60) days.

B. Abatement of Violation. The imposition of the penalties herein prescribed shall not preclude the City Attorney from instituting appropriate action to restrain, correct or abate a violation, or to prevent illegal Occupancy of a Structure or premise, or to stop an illegal act, conduct business or utilization of the Structure or premise.

CODE OF GENERAL ORDINANCES, 2021 - KENOSHA, WISCONSIN

CHAPTER XVII DIVISIONS AND COMBINATIONS OF LAND

17.01 AUTHORITY, PURPOSE, INTENT AND DEFINITIONS

A. Authority. This Ordinance is adopted under the authority granted by Section 236.45 of the Wisconsin Statutes.

B. Purpose. The purpose of this Ordinance is to regulate and control the division and combination of land within the corporate limits of the City of Kenosha, Wisconsin, and provide for the exercise of the City's extraterritorial Plat approval jurisdiction in order to promote the public health, safety, morals, prosperity, aesthetics, and general welfare of the City and its environs.

C. Intent. It is the general intent of this Ordinance to regulate the division of land so as to:

1. Obtain the wise use, conservation, protection, and proper development of the City's soil, water, wetland, woodland, and wildlife resources and attain a proper adjustment of land use and development to the supporting and sustaining natural resource base, and preserve natural vegetation and cover.

2. Lessen congestion in the streets and highways.

3. Further the orderly layout and appropriate use of land.

4. Reduce the potential for damage to properties by fire, natural disasters and environmental perils and facilitate emergency response.

5. Provide adequate light and air.

6. Facilitate adequate provision for housing, transportation, water supply, storm water, wastewater, schools, parks, playgrounds, and other public facilities and services.

7. Reduce the potential for water pollution, disease, and other health hazards.

8. Reduce the potential for flood damage to properties and minimize expenditures for flood relief and flood control projects.

9. Restrict building sites in areas covered by poor soils or in areas poorly suited for development.

10. Facilitate the division of large tracts into smaller parcels of land.

11. Ensure adequate legal description and proper survey monumentation.

12. Provide for the administration and enforcement of this Ordinance.

13. Provide penalties for violations of this Ordinance; and,

14. Implement Comprehensive Plan.

D. Abrogation and Greater Restrictions. It is not intended by this Ordinance to repeal, abrogate, or annul land divisions approved prior to the passage of this Ordinance. However, the provisions of this Ordinance shall govern further land divisions and combinations of previously divided or combined land.

E. Interpretation. In their interpretation and application, the provisions of this Ordinance shall be held to be minimum requirements which may be supplemented by additional requirements in land use approvals, licenses and permits. This Ordinance shall be liberally construed in favor of the City and shall not be deemed a limitation or repeal of any other power granted by Federal Law, the Wisconsin Statutes, or City Zoning or General Ordinances.

F. Severability. If any section, or portion of this Ordinance is adjudged unconstitutional, invalid or unenforceable by a court of competent jurisdiction, the remainder of this Ordinance shall be severable and shall remain in full force and effect.

G. Disclaimer. The City does not guarantee, warrant, or represent that compliance with this Ordinance will prevent flooding problems, sanitation problems, or structural damage to buildings.

H. Conflict with Other Ordinances. Should this Ordinance conflict with any General and/or Zoning Ordinances, or parts thereof, the most stringent standards shall apply.

I. Time Limits. Any references to days in this Ordinance in reference to time limits shall mean calendar days, unless otherwise specified.

J. Title. This Ordinance shall be known as, referred to, or cited as the "**DIVISIONS AND**

CODE OF GENERAL ORDINANCES, 2021 - KENOSHA, WISCONSIN

COMBINATIONS OF LAND".

17.02 DEFINITIONS

A. General Definitions. For the purposes of this Ordinance, the following definitions shall be used. Words used in the present tense include the future; the singular number includes the plural number; and the plural number includes the singular number. The word "shall" is mandatory and not discretionary.

B. Specific Words and Phrases. For purposes of this Chapter, the following words and phrases shall have the meaning provided.

Alley. A public or private way affording only secondary access to abutting properties.

Arterial Street. A street used, or intended to be used primarily for fast or heavy through traffic. Arterial street shall include freeways and expressways, as well as standard arterial streets, highways and parkways. **[See Illustration No. 2.]**

Assurance. A letter of credit or cash escrow deposited with the City as approved by the City Attorney for the purposes of guaranteeing the installation of required improvements, and giving the City the ability to construct, cause to be constructed, repair or reconstruct required improvements not constructed or installed, or not properly constructed or installed.

Block. A tract of land bounded by streets, or a combination of streets, public parks, cemeteries, railway right-of-ways, shorelines of navigable waters, and/or municipal boundaries.

Certified Survey Map. A map prepared by a Registered Land Surveyor in accordance with Section 236.34, Wisconsin Statutes, used to create land divisions which do not result in a Subdivision.

City Engineer. The City Engineer and designees thereof.

Collector Street. A street used, or intended to be used, to carry traffic from minor streets to the major system of arterial streets, including the principal entrance streets to residential developments. **[See Illustration No. 2.]**

Commercial Construction. The act of building any structure, or that part of any structure that is not designed or used exclusively for single-family and two-family residences.

Commercial Real Estate Development. A Land Division for Commercial Construction or making improvements to facilitate or allow Commercial Construction.

Comprehensive Plan. The extensively developed plan, also called a Master Plan, adopted by the City Plan Commission, and certified to the Common Council pursuant to Section 62.23 of the Wisconsin Statutes, including detailed neighborhood plans, proposals for future land use, transportation, urban redevelopment and public facilities. Devices for the implementation of these plans, such as zoning, official map, land division, and building line Ordinances and Capital Improvement Plans shall also be considered a part of the Comprehensive Plan.

Corner Lot. A lot abutting two (2) or more streets at their intersection, provided that the corner of such intersection shall have an angle of 135 degrees or less, measured on the lot side **(see Illustration No. 1)**.

Cul-de-Sac Street. A local street with only one (1) outlet and having an appropriate turnaround for the safe and convenient reversal of traffic movement. **[See Illustration No. 2.]**

Developer. Any person who constructs a building or structure upon land within the limits of the City of Kenosha.

Development Agreement. An agreement entered into by and between a Subdivider/Developer, the City and Kenosha Water Utility, with respect to any approved land division, which provides, among other things, for the design, construction and installation of required public improvements, the payment for such public improvements, dedication of land or acceptance of the dedication of completed public improvements, restrictive covenants running with the land, or other matters relating to land division, to development and use of land included in the land division or to the administration and enforcement of the agreement.

CODE OF GENERAL ORDINANCES, 2021 - KENOSHA, WISCONSIN

Director. Director of City Development.

Double Frontage Lot. A lot, other than a corner lot, with frontage on more than one (1) street. Double frontage lots shall normally be deemed to have two (2) front yards and two (2) side yards and no rear yard. [See Illustration No. 1.]

Extraterritorial Plat Approval Jurisdiction. The unincorporated area within three (3) miles of the corporate limits of the City of Kenosha, as those corporate limits may exist from time to time.

Final Plat. A map prepared in accordance with the requirements of Chapter 236 of the Wisconsin Statutes and this Ordinance for the purpose of dividing larger parcels of land into lots and conveying those lots.

Flag Lot. A lot fronting or abutting a public street, and where access to the public street system is by a narrow strip of land. [See Illustration No. 1.]

Frontage Street. A minor street auxiliary to and located on the side of an arterial street for control of access and for service to the abutting development. [See Illustration No. 2.]

General Manager of Kenosha Water Utility. General Manager of the Kenosha Water Utility and designees thereof.

Interior Lot. A lot other than a corner lot, with frontage on one street. (See Illustration No. 1.)

Kenosha Water Utility or Water Utility. A municipally owned public water utility organized and existing under authority of Section 66.0805, Wisconsin Statutes, and Chapter 32 of the Code of General Ordinances.

Land Division shall mean a Subdivision, Certified Survey Map, Lot Line Adjustment Survey or Replat.

Letter of Credit. An irrevocable agreement, entered into by a bank, savings and loan association or other financial institution, authorized to do business in the State of Wisconsin, and having a financial standing acceptable to the City, which secures a Subdivider's obligation to pay the cost of designing, construction, and installing required public improvements, providing for repair or replacement under warranty, and certain other obligations in connection with an approved Land Division.

Lot. A parcel of land of sufficient size to meet minimum zoning requirements for use, width, and area as set forth in the City of Kenosha Zoning Ordinance.

Lot Line Adjustment Survey. A survey prepared by a registered land surveyor for the purpose of accomplishing the alteration of existing property boundaries which does not result in the creation of additional lots and does not result in the dedication of public lands or right-of-ways.

Minor Street. A street used, or intended to be used, primarily for access to abutting properties. [See Illustration No. 2.]

Municipality. An incorporated village or city.

Objecting Agency. An agency empowered to object to a Subdivision Plat pursuant to Chapter 236, Wisconsin Statutes.

Official Map. The duly adopted map of the City of Kenosha showing the official street layout and Comprehensive Land Use Plan as adopted by the Common Council in accordance with Section 62.23(6) of the Wisconsin Statutes.

Outlot. A parcel of land, other than a lot or block, so designated on the Plat, but not of standard lot size, which may be either redivided into lots or combined with one (1) or more other adjacent outlots or lots in adjacent Land Divisions in the future for the purpose of creating buildable lots.

Parcel Combination. Any action which results in two (2) or more parcels of land being combined into a single parcel of land.

Person. Any person, party, firm or corporation.

Plat. A preliminary or final map of a Subdivision.

Preliminary Plat. A Plat that precisely describes the location and exterior boundaries of the parcel proposed to be divided, and shows the approximate location of lots and other improvements.

Public Way. Any public road, street, highway, alley, pedestrian right-of-way, drainageway, or part thereof.

CODE OF GENERAL ORDINANCES, 2021 - KENOSHA, WISCONSIN

Replat. A Plat which changes the boundaries of a recorded Subdivision Plat or part thereof. The division of a large block, lot or outlot within a recorded Subdivision Plat without changing the exterior boundaries of said block, lot or outlot, is not a Replat.

Residential Construction. The act of building any structure, or that part of any structure designed or used exclusively for single-family and two-family residences.

Residential Real Estate Development. A Land Division for Residential Construction or involving improvements to facilitate or allow Residential Construction.

Reviewing Agencies shall mean all State agencies and City departments, boards, commissions and committees required to review a Subdivision Plat or Certified Survey Map, Lot Line Adjustment Survey, or Replat under this Ordinance and State Statutes.

Sanitary Sewer Service Area. The area within and surrounding a city, village, or special purpose district that is served or planned to be served with public sanitary sewerage facilities.

Shorelands. Those lands lying within: one thousand (1,000') feet from the high water elevation of navigable lakes, ponds, and flowages, or three hundred (300') feet from the high water elevation of navigable streams or to the landward side of the floodplain, whichever is greater.

Subdivided. A lot, parcel or tract of land divided by a Subdivision, Certified Survey Map, Lot Line Adjustment Survey, or Replat.

Subdivider. A Person who creates, or who is required by operation of law to create a Subdivision, Certified Survey Map, Lot Line Adjustment Survey, Parcel Combination or Replat of any lots, parcel or tract of land within the jurisdiction of this Ordinance.

Subdivision. The division of a lot, parcel, or tract of land by the owners thereof, or their agents, for the purpose of transfer of ownership or building development where the act of division creates five (5) or more parcels or building sites of one and one-half (1.5) acres each or less in area; or where the act of division creates five (5) or more parcels or building sites of one and one-half (1.5) acres each or less in area by successive division within a period of five (5) years in accordance with Chapter 236, Wisconsin State Statutes.

Traditional Neighborhood Development. Compact, mixed use neighborhood, where residential, commercial, and civic buildings are within close proximity to each other.

Wetland. An area where water is at, near, or above the land surface long enough to be capable of supporting aquatic or hydrophytic vegetation and which has soils indicative of wet conditions.

Wisconsin Administrative Code. The rules of administrative agencies having rule-making authority in Wisconsin, published in a looseleaf, continual revision system as directed by Section 35.93 and Chapter 227, Wisconsin Statutes, including subsequent amendments to those rules.

C. References to State Statutes, Wisconsin Administrative Code and City Ordinances.

References to State Statute, Wisconsin Administrative Code, and City Ordinances shall include those existing on the effective date of this Ordinance, and subsequent revisions, replacements and recodifications.

17.03 GENERAL PROVISIONS

A. Jurisdiction. This Ordinance shall apply to and include all lands within the corporate limits of the City of Kenosha, Wisconsin, lands within a City Growth Area defined under Section 66.0307, Wisconsin Statutes, (as it then existed), and those lands within the extraterritorial jurisdiction of the City as established in Sections 62.23(2), 66.0105, and 236.10, Wisconsin Statutes. The provisions of this Ordinance as it applies to divisions of tracts of land into less than five (5) parcels for any use shall not apply to:

1. Transfers of interests in lands by will or pursuant to court order.
2. Leases for a term not to exceed ten (10) years, mortgages, or easements.
3. Those Plats listed in Section 236.03(2) and (3) of the Wisconsin Statutes.

CODE OF GENERAL ORDINANCES, 2021 - KENOSHA, WISCONSIN

B. Compliance. No person shall divide, convey, quit claim to, or combine any land located within the jurisdictional limits of this Ordinance so that such division or combination would result in a Subdivision, Certified Survey Map, Lot Line Adjustment Survey, Parcel Combination or Replat, as defined herein; no such Subdivision, Certified Survey Map, Lot Line Adjustment Survey, Parcel Combination or Replat shall be entitled to recording; and, no street shall be laid out or improvements made to land without compliance with all requirements of this Ordinance and the following:

1. Chapter 236, Wisconsin Statutes.
2. Rules of the Wisconsin Department of Commerce regulating lot size and lot elevation if the land to be subdivided is not served by a public sewer and provisions for such service have not been made.
3. Rules of the Wisconsin Department of Transportation relating to safety of access and the preservation of the public interest and investment in the highway system if the land owned or controlled by the Subdivider abuts on a State Trunk Highway or connecting street.
4. Rules of the Wisconsin Department of Natural Resources setting water quality standards preventing and abating pollution, and regulating development within the floodland, wetland, and shoreland areas.
5. Duly approved Comprehensive Plan.
6. The City of Kenosha Zoning Ordinance, the Code of General Ordinances, and all other applicable County Ordinances enforceable within the corporate limits of the City.

C. Violations. It shall be a violation of this Ordinance for any Person to divide, convey, record, build upon, combine or place monuments on any land contrary to the provisions of this Ordinance or the Wisconsin Statutes; and no Subdivider shall be issued a Building Permit by the City authorizing the building on, or improvement of, any Subdivision, Certified Survey Map, Lot Line Adjustment Survey, Parcel Combination or Replat within the jurisdiction of this Ordinance not of record as of the effective date of this Ordinance until the provisions and requirements of this Ordinance have been fully met. The City may institute appropriate action or proceedings to enjoin violations of this Ordinance and/or the applicable Wisconsin Statutes.

D. Drainage to be Maintained. It shall be unlawful to obstruct the flow of surface water contrary to an approved drainage plan so as to prevent surface water from reaching a storm sewer or drainage channel without interim ponding, except as provided in an approved drainage plan.

E. Administration. This Ordinance shall be administered by the Director of City Development, who shall:

1. Distribute copies of Subdivision Plats, Certified Survey Maps, Lot Line Adjustment Surveys, Parcel Combinations and Replats for review as provided in this Ordinance, and shall receive review comments from those departments, agencies, boards and committees required to comment thereon.
2. Advise the Subdivider of all recommendations made by the departments, agencies, boards, commissions and committees, and actions taken by the Common Council.
3. Maintain records of Subdivision Plats, Certified Survey Maps, Lot Line Adjustment Surveys, Parcel Combinations and Replat filings and actions taken. A record of fees paid and assurances posted are to be maintained by the City Clerk/Treasurer.
4. Determine that all Land Divisions and Parcel Combinations within the jurisdiction of this Ordinance requiring review by this Ordinance have been submitted for necessary review and action.
5. Assist the City Attorney in the prosecution of Ordinance violations.

F. Penalties and Remedies. Any Person who violates or fails to comply with the provisions of this Ordinance shall, upon conviction thereof, forfeit not less than One Hundred (\$100.00) Dollars, nor more

CODE OF GENERAL ORDINANCES, 2021 - KENOSHA, WISCONSIN

than One Thousand (\$1,000.00) Dollars, plus the costs of prosecution for each offense, and the penalty for default of payment of such forfeiture and costs shall be imprisonment in the County Jail until payment thereof, but not exceeding six (6) months for each offense. Each day a violation exists or continues shall constitute a separate offense. Violations and concomitant penalties shall include, but not be limited to:

1. Recordation improperly made carries penalties as provided in Section 236.30, Wisconsin Statutes.
2. Conveyance of lots in unrecorded Plats carries penalties as provided for in Section 236.31, Wisconsin Statutes.
3. Monuments disturbed or not placed carries penalties as provided for in Section 236.32, Wisconsin Statutes.
4. An assessor's Plat made under Section 70.27 of the Wisconsin Statutes may be ordered as a remedy by the City, at the expense of the Subdivider, when a Subdivision as defined herein is created by successive divisions of land.

G. Special Exceptions. The Common Council may grant a special exception from any requirements of this Ordinance, upon recommendation from the City Plan Commission and Public Works Committee, if all of the following criteria are met:

1. **Unique Circumstances.** There are exceptional, extraordinary, or unusual circumstances or conditions where a literal enforcement of the requirements of this Ordinance would result in severe hardship. Such hardships should involve unique circumstances applicable to the land and not be of such a recurrent nature as to negate this Ordinance.
2. **Preservation of Property Rights.** The special exception is necessary for the preservation and enjoyment of substantial property rights possessed by other property owners in the same vicinity.
3. **Absence of Detriment.** The special exception will not create substantial detriment to adjacent property and will not materially impair or be contrary to the purpose and spirit of this Ordinance or the public interest.
4. **Conformity.** The special exception will not conflict in any way with the Wisconsin State Statutes or the Comprehensive Plan.
5. **Minimum Application.** That the special exception shall be applied to the minimum extent practical in order to provide reasonable relief to the requirements of this Ordinance.

H. Recording. All Land Divisions and Parcel Combinations shall be recorded within the time limits specified. If not timely recorded, the Land Division or Parcel Combination approval shall be null and void, unless the time for recording has been extended by the Review Authority.

17.04 LAND DIVISION PROCEDURES AND REQUIREMENTS

A. Pre-Application. It is recommended that prior to the filing of an application for the approval of a Subdivision Plat, Certified Survey Map, Lot Line Adjustment Survey, Parcel Combination or Replat, the Subdivider consult with the Director of City Development in order to obtain advice and assistance. This consultation is intended to inform the Subdivider of the purpose and objectives of this Ordinance, and of the Comprehensive Plan, and to otherwise assist the Subdivider in planning the development. A Subdivider who files a conceptual Subdivision Plat or Certified Survey Map for review shall pay the fee therefor established by the Common Council, from time to time, by Resolution.

B. Public Ways. Whenever a tract of land to be divided within the jurisdiction of this Ordinance encompasses all or any part of a Public Way which has been designated on the Comprehensive Plan, said Public Way shall be made a part of the Subdivision Plat or Certified Survey Map and dedicated or reserved by the Subdivider in the locations and dimensions indicated on said Comprehensive Plan and in compliance

CODE OF GENERAL ORDINANCES, 2021 - KENOSHA, WISCONSIN

with the design standards for Land Divisions, **Section 17.09** of this Ordinance.

C. Park Sites, Environmental Corridors, and Other Open Spaces. Whenever a tract of land to be divided within the City encompasses all or any part of a park site, primary environmental corridor, or other open space which has been designated on the Comprehensive Plan, said lands shall be made a part of that Subdivision Plat or Certified Survey Map and dedicated or reserved by the Subdivider in the locations and dimensions indicated on said plan in accordance with the procedures set forth in **Section 17.09 I.** of this Ordinance.

D. Improvements. The Subdivider shall, before the recording of the Subdivision Plat or Certified Survey Map, enter into a Developers Agreement with the City and the Kenosha Water Utility agreeing to install and construct the required improvements within a time certain and shall file an assurance drafted or approved by the City Attorney in an amount equal to the estimated cost of the improvements determined by the City and Water Utility, as applicable. The Subdivider shall install and construct all required improvements and maintain required improvements unless and until accepted by the City and/or Water Utility.

E. Land Suitability. No land shall be divided for any use which is determined to be unsuitable for such use by the Common Council, upon the recommendation of the City Engineer or any other agency consulted by the Common Council for reason of flooding, inadequate drainage, adverse soil condition or rock formation, unfavorable topography or any other feature likely to be detrimental to the health, safety or welfare of the future residents/occupants of the proposed Land Division. In addition, the City may require that lands altered or filled to a depth of four (4') feet or more with earth or nonearth materials shall not be divided into building sites, except where soil tests prepared by a professional engineer clearly show that the soils are suited to development. Soil reports may be required to consider, but need not be limited to, an evaluation of soil permeability, depth to groundwater, depth to bedrock, soil bearing capacity, soil compaction, and the presence of toxic or hazardous materials. Where the Common Council determines land is not suitable for development, it shall, in writing, recite the particular facts upon which it bases its conclusion and afford the Subdivider an opportunity to present evidence in rebuttal to such finding of unsuitability. Thereafter, the Common Council may affirm, modify, or withdraw its determination of unsuitability.

F. Preliminary Plat Review. In all phased developments, the Subdivider shall submit a Preliminary Plat and application. The Subdivider of a single phase development may submit a Preliminary Plat. The Preliminary Plat shall be prepared in accordance with this Ordinance. The Subdivider shall file with the Director of City Development the number of copies determined by the Director of City Development of the Plat and the application. The Subdivider shall pay the review fee therefor established by the Common Council, from time to time, by Resolution. The review fee entitles the Subdivider to two (2) permitted reviews, one (1) initial review and one (1) resubmittal. All further resubmittals submitted after the two permitted reviews will be conducted only upon payment of a resubmittal fee established by the Common Council, from time to time, by Resolution.

1. The Subdivider shall, pursuant to Section 236.12(6) of the Wisconsin Statutes, submit the original drawing of the Preliminary Plat directly to the Wisconsin Department of Administration, which will prepare and forward copies of the Plat, at the Subdivider's expense, to the Objecting Agencies. It shall be the responsibility of the Subdivider to submit the additional copies required by this Ordinance.

2. The Director of City Development shall provide copies of the Preliminary Plat to the Reviewing Agencies for their review and recommendations concerning matters within their jurisdiction.

CODE OF GENERAL ORDINANCES, 2021 - KENOSHA, WISCONSIN

3. If the Plat or any portion thereof is within one thousand (1,000') feet of a village, the Director of City Development, as provided in Section 236.11(2) of the Wisconsin Statutes, shall provide to the Village Clerk at least ten (10) days prior written notice of the City's intention to approve the Plat, but failure to give such notice shall not invalidate any such Plat.

4. The City Plan Commission and Public Works Committee shall examine the Preliminary Plat as to its conformance with this Ordinance; consider review comments from Objecting and Reviewing Agencies required to review and comment on the Plat; and shall recommend approval, approval with conditions or rejection of the Preliminary Plat to the Common Council.

G. Preliminary Plat Approval. The Objecting Agencies shall, within twenty (20) days of the date of receiving their copies of the Preliminary Plat, notify the Subdivider and all other Objecting Agencies of any objections. If there are no objections, they shall so certify on the face of the copy of the Plat and shall return that copy to the Director of City Development. If an objecting agency fails to act within twenty (20) days, it shall be deemed to have no objection to the Plat. In addition:

1. The Common Council shall, within ninety (90) days of the date of filing of a Preliminary Plat with the Director of City Development, approve, approve conditionally, or reject such Preliminary Plat. One (1) copy of the Plat shall thereupon be returned to the Subdivider with the date and action endorsed thereon; and if approved conditionally or rejected, a letter setting forth the conditions of approval or the reasons for rejection. One (1) copy each of the Plat and letter shall be placed in the Department of City Development file. Failure of the Common Council to act within ninety (90) days shall constitute an approval of the Plat, as filed, unless the review period is extended by mutual consent of the Director of City Development and Subdivider.

2. Approval or conditional approval of a Preliminary Plat shall not constitute automatic approval of the Final Plat, except that if the Final Plat is submitted within thirty-six months of the last required approval by the Common Council or state, if applicable of the Preliminary Plat and conforms substantially to the Preliminary Plat layout as indicated in Section 236.11(1)(b) of the Wisconsin Statutes, the Final Plat shall be entitled to approval with respect to such layout. Any agency vested by law to have final approving authority of a plat may extend the time for submission of a Final Plat. The Preliminary Plat shall be deemed an expression of approval or conditional approval of the layout submitted as a guide to the preparation of the Final Plat, which will be subject to further consideration by the City Plan Commission and the Common Council at the time of its submission. The Director of City Development shall provide his or her conclusions as to whether the Final Plat conforms substantially to the Preliminary Plat and provide his or her recommendations on approval of the Final Plat. The conclusions and recommendation shall be made a part of the record of the proceeding at which the Final Plat is being considered and are not required to be submitted in writing.

H. Final Plat Review. The Subdivider shall submit a Final Plat and an application in accordance with this Ordinance and shall file with the Director of City Development the number of copies determined by the Director of City Development of the Plat and the application. The Subdivider shall pay the review fee therefor established by the Common Council, from time to time, by Resolution. The review fee entitles the Subdivider to two (2) permitted reviews; one (1) initial review and one (1) resubmittal. All further resubmittals submitted after the two permitted reviews will be conducted only upon payment of a resubmittal fee therefor established by the Common Council, from time to time, by Resolution.

1. The Subdivider shall, pursuant to Section 236.12(6) of the Wisconsin Statutes, submit the original drawing of the Final Plat directly to the Wisconsin Department of Administration, which will prepare and forward copies of the Plat at the Subdivider's expense to the Objecting Agencies. It is the responsibility of

CODE OF GENERAL ORDINANCES, 2021 - KENOSHA, WISCONSIN

the Subdivider to submit the additional copies of the Final Plat to the Director of City Development for review as required by this Ordinance.

2. The Director of City Development shall provide copies of the Final Plat and application to the Reviewing Agencies for their review and recommendations concerning matters within their jurisdiction.

3. If the Plat or any portion thereof is within one thousand (1,000') feet of a village, the Director of City Development, as provided in Section 236.11(2) of the Wisconsin Statutes, shall provide to the Village Clerk at least ten (10) days prior written notice of the City's intention to approve the Plat, but failure to give such notice shall not invalidate any such Plat.

4. The City Plan Commission and Public Works Committee shall examine the Final Plat as to its conformance with the approved Preliminary Plat.

I. Final Plat Approval. The Objecting Agencies shall, within twenty (20) days of the date of receiving their copies of the Final Plat, notify the Subdivider and all other Objecting Agencies of any objections. If there are no objections, they shall so certify on the face of the copy of the Plat and shall return that copy to the Director of City Development. If an Objecting Agency fails to act within twenty (20) days, it shall be deemed to have no objection to the Plat. In addition:

1. A Final Plat shall be submitted within six (6) months of the last required approval of the Preliminary Plat.

2. The Common Council shall, within sixty (60) days of the date of filing of a Final Plat with the Director of City Development, approve, approve conditionally, or reject such Final Plat. One (1) copy of the Plat shall thereupon be returned to the Subdivider with the date and action endorsed thereon; and, if approved conditionally or rejected, a letter setting forth the conditions of approval or the reasons for rejection shall accompany the plat. One (1) copy each of the Plat and letter shall be placed in the Department of City Development file. Failure of the Common Council to act within sixty (60) days shall constitute an approval of the Plat, as filed, unless the review period is extended by mutual consent of the Director of City Development and Subdivider.

3. Upon failure of the Common Council to take action on the Plat within sixty (60) days, the Plat shall be deemed approved, provided the time having not been extended and no unsatisfied objections having been filed, and all fees payable by the Subdivider having been paid.

4. After the Final Plat has been approved by the Common Council and the State, and an assurance assuring the construction and installation of required improvements is filed, the City Clerk/Treasurer shall cause the certificate inscribed upon the Plat attesting to such approval to be duly executed. The Director of City Development shall then record the Plat with the Kenosha County Register of Deeds, within twelve (12) months of the last approval, and within thirty-six (36) months of the first approval.

J. Appeals. Any person aggrieved by an objection to a Plat or a failure to approve a Plat may appeal such objection or failure to approve as provided in Section 236.13(5) of the Wisconsin Statutes, within thirty (30) days of notification of the objection to the Plat or of the failure to approve the Plat.

K. Certified Survey Map Review and Approval. A Certified Survey Map shall be required for any divisions of land which would not be accomplished by Subdivision, Replat or Lot Line Adjustment Survey. The Subdivider shall prepare the Certified Survey Map in accordance with this Ordinance and the

CODE OF GENERAL ORDINANCES, 2021 - KENOSHA, WISCONSIN

Subdivider shall file with the Director of City Development the number of copies determined by the Director of City Development of the Certified Survey Map and application. The Subdivider shall pay the review fee therefor established by the Common Council, from time to time, by Resolution. The review fee entitles the Subdivider to two (2) permitted reviews; one (1) initial review and one (1) resubmittal. All further resubmittals submitted after the two permitted reviews will be conducted only upon payment of a resubmittal fee therefor established by the Common Council, from time to time, by Resolution. In addition:

1. The Director of City Development shall provide copies of the Certified Survey Map and application to the Reviewing Agencies for their review and recommendation concerning matters within their jurisdiction.
2. The Common Council, upon receiving City Plan Commission and Public Works Committee recommendations, shall approve, approve conditionally or reject such map within ninety (90) days from the date of filing of the map with the Director of City Development unless the time is extended by mutual consent of the Director of City Development and Subdivider. If the map is rejected, the reason(s) shall be stated in the minutes of the meeting and a written statement forwarded to the Subdivider.
3. After the Certified Survey Map has been approved by the Common Council, and the assurance assuring the construction and installation of required improvements is filed, the City Clerk/Treasurer shall cause the certificate to be inscribed upon the map attesting to such approval to be duly executed. The Director of City Development shall then record the map with the Kenosha County Register of Deeds within six (6) months of Common Council approval.

L. Lot Line Adjustment Survey Review and Approval. A Lot Line Adjustment Survey shall be required for any divisions of land which do not alter the exterior boundaries of the parcels being surveyed and do not result in the creation of additional lots. The Subdivider shall prepare the Lot Line Adjustment Survey in accordance with this Ordinance, and the Subdivider shall file with the Director of City Development the number of copies determined by the Director of City Development of the Lot Line Adjustment Survey and the application. The Subdivider shall pay the review fee therefor established by the Common Council, from time to time, by Resolution. The review fee entitles the Subdivider to two (2) permitted reviews; one (1) initial review and one (1) resubmittal. All further resubmittals submitted after the two permitted reviews will be conducted only upon payment of a resubmittal fee therefor established by the Common Council, from time to time, by Resolution.

1. The Director of City Development shall, within thirty (30) days from the date of filing of the survey with the Director of City Development, unless the time is extended by mutual consent of the Director of City Development and Subdivider, approve or reject the survey, and transmit the decision in writing to the Subdivider. If the Survey is rejected, the reason(s) shall be stated in a written statement forwarded to the Subdivider. Any Subdivider objecting to the decision of the Director of City Development may appeal the decision to the Common Council. Such appeal shall be filed with the Director of City Development within thirty (30) days of the date of the decision by the Director of City Development.
2. Upon written approval by the Director of City Development, the Subdivider shall record the Survey and deed with the Kenosha County Register of Deeds within ninety (90) days from the date of said approval.
3. The Subdivider shall, within ten (10) days following recording of the Survey, file four (4) copies of

CODE OF GENERAL ORDINANCES, 2021 - KENOSHA, WISCONSIN

the recorded Survey and deed with the Director of City Development.

4. Lot Line Adjustment Surveys proposed in the extraterritorial jurisdiction are excluded from this review and approval process.

M. Extraterritorial Plat and Certified Survey Map Review and Approval. When it is proposed to divide lands located in an unincorporated area within three (3) miles of the corporate limits of the City of Kenosha by Subdivision Plat or Certified Survey Map, the Subdivider shall proceed as specified in Sections 17.04 A. through K. of this Ordinance, with the following exceptions or additions:

1. The Town Clerk or the Kenosha County Planning and Development Department, to whom the Plat or Certified Survey Map is first submitted, shall be responsible for transmitting copies of the Plat or Map to designated Objecting (respecting Subdivisions) and Reviewing Agencies unless the Subdivider has specifically requested that the City assume the responsibility of transmitting all review copies. The Subdivider shall specify in the application to whom the original application was submitted.

2. If the Extraterritorial Plat or Certified Survey Map contains lands located within the adopted Sanitary Sewer Service Area of the Kenosha Water Utility, the Subdivider shall comply with all of the improvement requirements of Section 17.10 of this Ordinance and with all of the design standards of Section 17.09 of this Ordinance. If the Extraterritorial Plat or Certified Survey Map does not contain lands located within the Sanitary Sewer Service Area of the Kenosha Water Utility, the Subdivider shall comply with all of the design standards of Section 17.09 of this Ordinance. In either event, the Subdivider shall not be required to dedicate park and open space land to the City or be required to pay a public site fee to the City.

3. The following areas are excluded from this review and approval process. Land located outside of the City Growth Area approved under Section 66.0307, Wisconsin Statutes, as said Statute then existed.

N. Replat. When it is proposed to Replat a recorded Subdivision, or part thereof, so as to change the boundaries of a recorded Subdivision, or part thereof, the Subdivider shall vacate or alter the recorded Plat as provided in Sections 236.40 through 236.44 of the Wisconsin Statutes. The Subdivider shall then proceed as specified in Sections 17.04 A. through 17.04 J. of this Ordinance. The review fee for a Replat shall be the same as the review fees established for Final Plats.

17.05 PRELIMINARY PLAT

A. General. A Preliminary Plat shall be required for all phased Subdivisions and shall be based upon a survey by a registered land surveyor and the Plat prepared on reproducible paper or film not to exceed thirty-six (36") inches in width and at a map scale of not more than one hundred (100') feet to the inch. Where more than one page is used to show the entire area to be Platted at the required scale, then a single page shall be submitted at any scale that shows the entire area to be Platted. The Preliminary Plat shall show correctly and legibly on its face the following information:

1. Title or name under which the proposed Subdivision is to be recorded. Such title shall not be the same or similar to a previously approved and recorded Plat, unless the proposed Subdivision is an addition to a previously recorded Plat and the Plat is noted to be an addition.

2. Location of the proposed Subdivision by: government lot, quarter section, section, township, range, county and State.

3. General sketch showing the location of the proposed Subdivision within the U.S. Public Land Survey section.

CODE OF GENERAL ORDINANCES, 2021 - KENOSHA, WISCONSIN

4. Date, graphic scale and north arrow.
5. Names and addresses of the owner, Subdivider and land surveyor preparing the Plat.
6. Entire area contiguous to the proposed Plat owned or controlled by the Subdivider, even though only a portion of said area is proposed for immediate development.
7. Exact length and bearing of the exterior boundaries of the proposed Subdivision referenced to a corner established in U.S. Public Land Survey and the total acreage encompassed thereby.
8. Existing contours at vertical intervals of not more than two (2') feet, where available. Elevations shall be marked on such contours based on City datum or National Geodetic Vertical Datum of 1929.
9. Water elevations of adjoining lakes and streams at the date of the survey and approximately high and low water elevations, all based on City datum or National Geodetic Vertical Datum of 1929.
10. Floodplain limits of the 100 year recurrence interval flood as determined by the Federal Flood Insurance Study or other technical document, or when such data are not available, the maximum flood of record.
11. Location, right-of-way width and names of all existing and proposed Public Ways, easements, railways and utility right-of-ways and all section and quarter section lines within the exterior boundaries of the proposed Subdivision or immediately adjacent thereto.
12. Type, width and elevation of any existing and proposed street pavements within the exterior boundaries of the Plat or immediately adjacent thereto, together with any legally established centerline elevations, based on City datum or National Geodetic Vertical Datum of 1929.
13. Location and names of any adjacent Subdivisions, parks and cemeteries.
14. Location, size and invert elevation of any existing sanitary and storm sewers, culverts and drain pipes, the location of manholes, catch basins, hydrants, and the location and size of any existing water and gas mains within the exterior boundaries of the Plat or immediately adjacent thereto. All elevations shall be based on City datum or National Geodetic Vertical Datum of 1929.
15. Locations of all existing property boundary lines, structures and the first floor elevation thereof, drives, visible and known wells, streams and watercourses, wetlands, rock outcrops, wooded areas, railway tracks and other similar significant natural or manmade features within the tract being subdivided or immediately adjacent thereto.
16. Approximate dimensions of all lots, together with proposed lot and block numbers.
17. Location and approximate dimensions and size of any sites to be reserved or dedicated for schools, parks, environmental corridors, drainageways, or other public use or open space, which are to be used for group housing, shopping centers, church sites, or other private uses not requiring lotting.
18. Approximate radii of all curves.
19. Existing zoning of land within and adjacent to the proposed Subdivision.
20. Any proposed riparian lake and stream access with a drawing clearly indicating the location of the proposed Subdivision in relation to the access.
21. Any proposed lake and stream improvement or relocations.
22. Plat shall include the entirety of all parcels in the proposed Subdivision.

B. Street Plans and Profiles. The City Plan Commission, upon the recommendation of the City Engineer, may require that the Subdivider provide street plans and profiles showing existing ground surface, proposed and established street grades, including extensions for a reasonable distance beyond the limits of the proposed Subdivision, when requested. All elevations shall be based upon City datum or U.S.G.S. datum, and plans and profiles shall meet the approval of the City Engineer.

C. Covenants. In the event that any common areas of a proposed Subdivision are to be Platted and maintained by an owners association as specified in the developers agreement, the City Plan Commission shall require submission of a draft of the protective covenants, for review by the City Attorney as to legality and form. The Protective Covenants shall be resubmitted by the Subdivider, with City recommended

CODE OF GENERAL ORDINANCES, 2021 - KENOSHA, WISCONSIN

amendments, where necessary. All other covenants do not require review and approval by the City.

D. Easements. Easements shall be shown on the Preliminary Plat and shall be identified as utility, drainage, conservation, access, scenic, mineral, air rights, or other designated easements. Easements shall not be used for the dedication and conveyance of public ways, park lands, or other public lands.

E. Affidavit. The surveyor preparing the Preliminary Plat shall certify on the face of the Plat that it is a correct representation of all existing Land Divisions and features, and that the surveyor has fully complied with the provisions of this Ordinance.

F. Traffic Impact Study. The City Plan Commission may require the Subdivider to submit a Traffic Impact Study for the proposed Subdivision if it is determined that the proposed Subdivision could create significantly increased traffic on existing streets bordering or serving the proposed Subdivision. The study may be used as a basis to require the Subdivider to pay a fair, pro rata share of the costs of street improvements and traffic control signs and signals which serve the proposed Subdivision.

G. Phased Development. The approved Preliminary Plat may be Final Platted in phases with each phase encompassing only a portion of the approved Preliminary Plat. However, it is required that each such phase be Final Platted with a minimum of ten (10) lots, except for the final phase which may contain any number of lots, and be designated as a phase of the approved Preliminary Plat. In any phased Subdivision with two (2) or more streets that will connect to the existing street system, the first Final Plat must include a minimum of two (2) of the street connections.

17.06 FINAL PLAT

A. General. A Final Plat prepared by a registered land surveyor shall be required for all proposed Subdivisions. It shall comply in all respects with the requirements of Section 236.20, Wisconsin Statutes, and this Ordinance. The sheet size for the Final Plat shall be 22" x 30".

B. Required Information. The Plat shall show correctly on its face, in addition to the information required by Section 236.20 of the Wisconsin Statutes, the following:

1. Exact length and bearing of the centerline of all streets.
2. Exact street width along the line of any obliquely intersecting street.
3. Railway right-of-ways within and abutting the Plat.
4. Utility and drainage easements.
5. All lands reserved for future public acquisition or reserved for the common use of property owners within the Plat.
6. A drainage plan for all lots in the Plat bearing a statement concerning the relationship and direction of flow of all drainage swales, ponds, or other facilities to each other.
7. Special restrictions required by the City Plan Commission relating to access control along Public Ways, to the provision of planting strips, to more restrictive yard requirements, or to special restrictions for environmentally significant lands, or to serve any other special needs of the City or Water Utility.
8. Plat shall include the entirety of all parcels involved in the proposed Subdivision.

C. Survey Accuracy. The City Engineer shall examine all Final Plats within the City and may make, or cause to be made by a registered land surveyor under the supervision or direction of the City Engineer, such field checks as the City Engineer may deem necessary or desirable for the accuracy and closure of survey, the proper kind and location of monuments and the legibility and completeness of the drawing.

CODE OF GENERAL ORDINANCES, 2021 - KENOSHA, WISCONSIN

D. State Plane Coordinate System. Where the Plat is located within a U.S. Public Land Survey quarter section, the corners of which have been relocated, monumented and placed on the State Plane Coordinate System by the City of Kenosha, Kenosha County or the Southeastern Wisconsin Regional Planning Commission, the Plat shall be tied directly to one or more of the section or quarter corners so relocated, monumented and coordinated. The exact grid bearing and distance of such tie shall be determined by field measurements, and the type of monument and Wisconsin State Plane Coordinates of the monument marking the relocated section or quarter corner to which the Plat is tied shall be indicated on the Plat. All distances and bearings shall be referenced to the Wisconsin Coordinate System, South Zone.

E. Traffic Impact Study. The City Plan Commission may require the Subdivider to submit a Traffic Impact Study for the proposed Certified Survey Map if it is determined that the proposed Certified Survey Map could create significantly increased traffic on existing streets bordering or serving the proposed Subdivision. The study may be used as a basis to require the Subdivider to pay a fair, pro rata share of the costs of street improvements and traffic control signs and signals which serve the proposed Subdivision.

F. Certificates. All Final Plats shall provide all certificates required by Section 236.21 of the Wisconsin Statutes; and, in addition, the surveyor shall certify compliance with all the provisions of this Ordinance. Model certificates are provided by the Department of City Development.

G. Recordation. The Final Plat shall only be recorded with the County Register of Deeds after the certificates of the Wisconsin Department of Administration, of the Common Council, of the surveyor, and those certificates required by Section 236.21, Wisconsin Statutes, are placed on the face of the Plat and executed by all parties. Upon recordation of the Plat, Subdivider shall submit copies of the Plat and all engineering drawings to the Department of City Development in digital formats approved by said Department.

17.07 CERTIFIED SURVEY MAP

A. General. A Certified Survey Map prepared by a registered land surveyor shall be required for all Divisions of land not accomplished by a Subdivision, Lot Line Adjustment Survey or Replat as defined in this Ordinance. It shall comply in all respects with the requirements of Section 236.34, Wisconsin Statutes. The Certified Survey Map shall also comply with the design standards and improvement requirements set forth in Sections 17.09 and 17.10 of this Ordinance.

B. Required Information. The map shall show correctly on its face, in addition to the information required by Section 236.34 of the Wisconsin Statutes, the following:

1. All existing structures and the first floor elevation thereof, visible and known wells, watercourses, drainage ditches and other pertinent features.
2. Utility and drainage easements.
3. All lands to be dedicated or reserved for public use.
4. Exact length and bearing of the centerline of all streets.
5. Exact street width along the line of any obliquely intersecting street.
6. Railway right-of-ways within and abutting the Map.
7. A drainage plan for all lots in the Map bearing a statement concerning the relationship and direction of flow of all drainage swales, ponds, or other facilities to each other.
8. Special restrictions required by the City Plan Commission relating to access control along Public Ways, to the provision of planting strips, to more restrictive yard requirements, to special restrictions for environmentally significant lands, or to serve any other special needs of the City or Water Utility.

CODE OF GENERAL ORDINANCES, 2021 - KENOSHA, WISCONSIN

9. Date of the map and any revision dates.
10. Graphic scale and north arrow on each sheet showing a layout feature.
11. Name and address of the owner, Subdivider and surveyor.
12. Map shall include the entirety of all parcels involved in the Certified Survey Map.

C. Additional Information. The Plan Commission may require that the following additional information be provided when necessary for the proper review and consideration of the map.

1. Existing contours at vertical intervals of not more than two (2') feet, where available. Elevations shall be marked on such contours based on City datum or National Geodetic Vertical Datum of 1929. The requirement to provide topographic data may be waived if the parcel or parcels created are fully developed.

2. Floodplain limits of the 100 year recurrence interval flood as determined by the Federal Flood Insurance Study or other technical document, or where such data is not available, the maximum flood of record.

3. Setbacks or building lines in accordance with the major street setbacks in the Zoning Ordinance or Wisconsin Department of Transportation guidelines.

4. The Plan Commission may require that the entire area contiguous to the land outlined in the proposed certified survey owned or controlled by the Subdivider shall be included on the Certified Survey Map even though only a portion of said area is proposed for immediate development.

D. State Plane Coordinate System. Where the map is located within a U.S. Public Land Survey quarter section, the corners of which have been relocated, monumented and placed on the State Plane Coordinate System by the City of Kenosha, Kenosha County or the Southeastern Wisconsin Regional Planning Commission, the Map shall be tied directly to one or more of the section or quarter corners so relocated, monumented and coordinated. The exact grid bearings and distance of such tie or ties shall be determined by field measurements, and the monument type and Wisconsin State Plane Coordinate of the monument marking the relocated section or quarter corner to which the map is tied shall be indicated on the map. All distances and bearing shall be referenced to the Wisconsin Coordinate System, South Zone.

E. Traffic Impact Study. The City Plan Commission may require the Subdivider to submit a Traffic Impact Study for the proposed Certified Survey Map if it is determined that the proposed Certified Survey Map could create significantly increased traffic on existing streets bordering or serving the proposed Subdivision. The study may be used as a basis to require the Subdivider to pay a fair, pro rata share of the costs of street improvements and traffic control signs and signals which serve the proposed Subdivision.

F. Certificates. The surveyor shall certify on the face of the map compliance with all the provisions of this Ordinance. The Common Council, after a recommendation by the Reviewing Agencies, shall certify its approval on the face of the map. In addition, all Certified Survey Maps shall provide all the certificates referenced in Section 236.21, Wisconsin Statutes, for Subdivisions. Model certificates are provided by the Department of City Development.

G. Recordation. The Certified Survey Map shall only be recorded with the County Register of Deeds after the certificates of the Common Council, surveyor, and those certificates referenced in Section 236.21, Wisconsin Statutes, for Subdivisions are placed on the face of the map, and executed by all parties.

17.08 LOT LINE ADJUSTMENT SURVEY

A. General. A Lot Line Adjustment Survey prepared by a registered land surveyor shall be required to accomplish the alteration of existing property boundaries which does not result in the creation of additional lots, from what was originally platted or mapped.

CODE OF GENERAL ORDINANCES, 2021 - KENOSHA, WISCONSIN

B. Required Information. The Lot Line Adjustment Survey shall show the information required by Section 236.34, Wisconsin Statutes, in addition to the following:

1. All existing structures, fences, driveways, and encroachments.
2. Utility and drainage easements.
3. Legal descriptions of the existing parcels, proposed parcels upon lot line adjustment and lands to be attached to said parcel(s).
4. Survey shall include the entirety of all parcels involved in the lot line adjustment.
5. Setbacks of all existing structures from all existing and proposed property boundaries.
6. Map date and any revision dates.
7. Graphic scale and north arrow.
8. Name and addresses of owner and surveyor.
9. Monumentation of new lot corners in accordance with Section 236.15, Wisconsin Statutes.

C. Additional Information. The Director of City Development may require that the following additional information be provided, when necessary, for the proper review and consideration of the Lot Line Adjustment Survey:

1. Drainage Plan, including elevations at all proposed and existing lot corners and first floor elevation of proposed and existing structures.
2. Setbacks or building lines in accordance with the major street setbacks established in the Zoning Ordinance or required by the Wisconsin Department of Transportation.

D. Certificates. The surveyor shall certify on the face of the survey compliance with the provisions of this Ordinance. The Director of City Development, upon recommendation by the Reviewing Agencies, shall certify the approval on the face of the survey. Model certificates are provided by the Department of City Development.

E. Recordation. Upon written approval by the Director of City Development, the Director of City Development shall record the Survey in conjunction with a deed with the Kenosha County Register of Deeds.

17.081 PARCEL COMBINATION

A. General. A Parcel Combination Affidavit shall be required to accomplish a Parcel Combination as defined in this Ordinance.

B. Required Information. A Parcel Combination Affidavit, as available from the Department of City Development, shall be completed with all required information.

C. Submittal. After completing the Parcel Combination Affidavit, the property owner shall submit the form to the Department of City Development for the Director of City Development to review for compliance with this Chapter and all other applicable Codes and Ordinances.

D. Recordation. Upon written approval by the Director of City Development, the property owner shall record the Parcel Combination Affidavit with the Kenosha County Register of Deeds within ninety days (90) from the date of the approval.

CODE OF GENERAL ORDINANCES, 2021 - KENOSHA, WISCONSIN

17.09 DESIGN STANDARDS FOR LAND DIVISIONS

A. Streets. In any new Land Division, the street layout shall conform to the arrangement, width and location indicated on the Official Map, County Jurisdictional Highway System Plan and Comprehensive Plan. In areas for which such plans have not been completed, the street layout shall recognize the functional classification of the various types of streets and shall be developed and located in proper relation to existing and proposed streets. The Land Division shall be designed so as to provide each lot with satisfactory access to a public street. In addition:

1. Arterial streets shall be arranged so as to provide ready access to centers of employment, centers of governmental activity, community shopping areas, community recreation, and points beyond the boundaries of the community. Arterial streets shall also be properly integrated with and related to the existing and proposed area-wide system of arterial streets and highways and shall be, insofar as practicable, continuous and in alignment with existing or planned streets with which they are to connect.

2. Collector streets shall be arranged so as to provide ready collection of traffic from residential areas and conveyance of this traffic to the major street and highway system and shall be properly related to the mass transportation system, to special traffic generators such as schools, churches and shopping centers and other concentrations of population and to the major streets to which they connect.

3. Minor streets shall be arranged to conform to the topography, to discourage use by through traffic, to permit the design of efficient storm and sanitary sewerage systems, and water supply systems, and to require the minimum street area necessary to provide safe and convenient access to abutting property.

4. Proposed streets shall extend to the boundary lines of the Land Division unless prevented by topography or other physical conditions, or as determined by the City Plan Commission. A temporary turnaround may be required on deadend streets over one hundred fifty (150') feet in length. If required, the temporary turnaround must be constructed with an asphalt surface within the boundaries of the Land Division, unless an easement can be obtained by the Subdivider from the adjoining property owner. The temporary turnaround can be removed, with an authorization from the Director of City Development, when related conditions within the developers agreement have been met.

5. Whenever the proposed Land Division contains or is adjacent to an arterial street or highway, adequate protection of residential properties, limitation of access and separation of through and local traffic shall be provided by reversed frontage, with screen planting contained in a nonaccess reservation along the rear property line, or by the use of frontage streets.

6. Stream or lake shores shall have an access Platted in accordance with Section 236.16(3) of the Wisconsin Statutes.

7. North-South oriented streets shall be numbered consecutively and shall be called "avenues". East-west oriented streets shall be numbered consecutively and shall be called "streets". North-south oriented streets Platted in between existing consecutively numbered "avenues" shall be called "courts". East-west oriented streets Platted in between existing consecutively numbered "streets" shall be called "places". Diagonal streets shall be named by the Common Council, upon recommendation by the City Plan Commission. Streets extended or projected, whether connected or intermittent, shall use the same name. Street names for noncontiguous streets shall not duplicate or be similar to existing street names located elsewhere in the City.

B. Limited Access Highway and Railway Right-of-Way Treatment. Whenever the proposed Land Division contains or is adjacent to a limited access highway or railway right-of-way, and when lots within the proposed Land Division back upon the right-of-way of an existing or proposed limited access highway or a railway, a planting strip at least twenty (20') feet in depth shall be provided adjacent to the highway or railway in addition to the normal lot depth. This strip shall be a part of the Platted lots, but shall have the following or equivalent restriction lettered on the face of the Plat: "This strip reserved for the planting of trees and shrubs; the building of structures hereon is prohibited."

C. Street Design Standards. The minimum right-of-way and roadway width of all proposed streets

CODE OF GENERAL ORDINANCES, 2021 - KENOSHA, WISCONSIN

shall be as specified by the Comprehensive Plan or County Jurisdictional Highway System Plan; or if no width is specified therein, the minimum widths shall be designed per City criteria approved by the Public Works Committee (Board of Public Works), and on file in the Department of Public Works. Cross-sections for freeways, expressways and parkways should be based upon detailed engineering studies. In addition:

1. Cul-de-Sac Streets. Cul-de-sac streets designed to have one end permanently closed shall not exceed seven hundred fifty (750') feet in length. Cul-de-sac streets shall terminate in a teardrop turnaround having a minimum right-of-way radius of sixty (60') feet and a minimum outside curb radius of forty-eight (48') feet. If a center island is provided, the island shall be landscaped and maintained by an owners association, and provide a minimum pavement width of twenty-four (24') feet. Detailed dimensions for a typical cul-de-sac are shown in **Illustration Nos. 3 and 4** to this Ordinance. Cul-de-sac streets shall be used only when the existing street layout or exceptional topography does not permit otherwise.

2. Street Grades. Unless necessitated by exceptional topography, the maximum centerline grade of any street shall not exceed five (5%) percent, nor be less than five-tenths (0.5) of one (1%) percent. Street grades shall be established, wherever practicable, so as to avoid excessive grading, removal of ground cover and tree growth, and general leveling of the topography. All changes in street grades shall be approved by the City Engineer.

3. Radii of Curvature. When a continuous street centerline deflects at any one point by more than ten (10°) degrees, a circular curve shall be introduced having a radius of curvature on said centerline of not less than the following:

- a. Arterial streets and highways: five hundred (500') feet.
- b. Collector streets: two hundred fifty (250') feet.
- c. Minor streets: one hundred (100') feet.

A tangent at least one hundred (100') feet in length shall be provided between reverse curves on arterial and collector streets.

4. Roadway Elevations. Elevations or roadways passing through floodplain areas shall be designed in the following manner:

- a. Arterial streets shall be designed so that they will not be overtopped by the 50 year recurrence interval flood.
- b. Minor streets shall be designed so that they will not be overtopped by the 10 year recurrence interval flood.

5. Half-Streets. Where an existing dedicated or Platted half-street is adjacent to the tract being subdivided, the other half of the street shall be dedicated by the Subdivider. The Platting of new half-streets is permitted, but development of property adjacent to half-streets is not permitted until the other half of the street has been dedicated and construction of the full street is completed.

D. Street Intersections. Streets shall intersect each other at as nearly right angles, where possible, as topography and other limiting factors of good design permit. In addition:

1. The number of streets converging at one intersection shall be limited to not more than two (2).
2. The number of intersections along arterial streets and highways shall be held to a minimum. Whenever practicable, the distance between such intersections shall not be less than one thousand two hundred (1,200') feet.
3. If the centerlines of minor streets approach arterial or collector streets from opposite sides within one hundred twenty-five (125') feet of each other, measured along the centerlines of the arterial or collector street, then the location shall be so adjusted that an aligned intersection is created.

E. Blocks. The widths, lengths and shapes of blocks shall be suited to the planned use of the land; zoning requirements, need for convenient access; control and safety of street traffic; and the limitations and opportunities of topography. In addition:

1. The length of blocks in residential areas should not be less than five hundred (500') feet, nor more

CODE OF GENERAL ORDINANCES, 2021 - KENOSHA, WISCONSIN

than one thousand (1,000') feet in length, unless otherwise dictated by exceptional topography or other limiting factors of good design or otherwise approved by the City Plan Commission.

2. The width of blocks shall be wide enough to provide for two (2) tiers of lots of appropriate depth, except where otherwise required to separate residential development from through traffic.

3. Utility easements shall, where practical, be placed along rear lot lines. All new utilities shall be placed underground.

F. Lots. The size, shape, and orientation of lots shall be appropriate for the location of the Land Division and for the type of development and land use contemplated. In addition:

1. Side lot lines shall be at right angles to straight street lines or radial to curved street lines on which the lots face. Lot lines shall follow municipal boundary lines, rather than cross them.

2. Double frontage and reverse frontage lots shall be prohibited, except where necessary to provide separation of residential development from through traffic or to overcome specific disadvantages of topography and orientation.

3. Every lot shall front or abut a public street for a distance of at least forty (40') feet. Flag lots not meeting the minimum frontage requirement shall be prohibited. Lots on curved public streets or public cul-de-sac streets shall comply with the lot frontage requirements of Section 3.03 C.4. of the Zoning Ordinance.

Exceptions to the public street lot frontage standards may be made for non-residential land divisions provided all of the following standards are met:

(a) Lots may front or abut a private paved street for a distance of at least forty (40') feet where the private street has a minimum width of twenty (20') feet and is constructed with curb and gutter;

(b) The private street was approved under a Site Plan Review or a Conditional Use Permit;

(c) Recorded access easements and any maintenance agreement are provided to the City with any Land Division application requested under this Section; and,

(d) Public street building setback requirements shall apply in the same manner with respect to private streets.

4. The average lot area shall be no less than ten thousand (10,000) square feet in each land division, or within each phase of the land division in a multi-phase development. No individual lot within a land division or within any phase of the land division in a multi-phase development shall be less than eight thousand (8,000) square feet in lot area.

Exceptions to the lot area/lot width standards may be made for land divisions:

(a) Which are located within existing developed neighborhoods having lesser or greater development standards. In such case, the minimum lot width and minimum lot area shall be determined by taking the average of all lots within a one thousand (1,000') foot radius from the land division perimeter; or,

(b) Which are located within an area having a duly adopted neighborhood plan having specified development standards.

5. Depth of lots shall be a minimum of one hundred twenty (120') feet, unless otherwise stated in the Zoning Ordinance. Excessive depth in relation to width shall be avoided and a proportion of two to one (2:1) shall generally be considered a desirable ratio of depth to width. Depth of lots or parcels reserved or laid out for commercial or industrial use shall be adequate to provide for off-street service and parking required by the use contemplated.

6. Lands lying between the meander line and the water's edge and any otherwise unplattable lands which lie between a proposed Land Division and the water's edge shall be included as part of lots, outlots or public dedications in any Plat abutting a lake or stream.

7. Grades of lot line swales shall be a minimum of one (1%) percent, except where exceptional topography exists to create undue hardship, the City Engineer may consider and approve an exception to this standard.

8. Lots whose only street access is the end of a dead end street, shall not have a driveway access,

CODE OF GENERAL ORDINANCES, 2021 - KENOSHA, WISCONSIN

unless a cul-de-sac or public street designed to City standards is constructed on the lot.

9. All corner lots shall be Platted with a radius at the intersection of the street right-of-way lines concentric with the standard curb and gutter radius.

G. Special Restrictions. Special restrictions which are appropriate to the location or design of the Land Division may be required by the Plan Commission and shall be shown on the Final Plat or Certified Survey Map. Examples of the application of this provision include, but are not limited to, access control along Public Ways, required planting or buffering strips, and prohibition of structures and vegetative clearing in environmentally significant lands.

H. Easements. The City Plan Commission may require utility easements of widths and location deemed adequate for providing facilities and utility service. Where a Land Division is traversed by a watercourse, drainageway channel or stream, an adequate drainageway or easement shall be provided. The location, width, alignment and improvements of such drainageway or easement shall be subject to the approval of the City Engineer and General Manager of Kenosha Water Utility. All easements shall be shown on the face of the Final Plat or Certified Survey Map.

I. Public Sites and Open Spaces. Suitable sites of adequate area shall be dedicated or reserved for schools, parks, environmental corridors, drainageways and other public purposes as provided in the Development Agreement. If designated on the Comprehensive Plan, such areas shall be made a part of the Plat as stipulated in Section 17.04 C. of this Ordinance. If not so designated, consideration shall be given in the location of such sites to the preservation of scenic and historic sites, woodlands, and other environmentally significant lands.

The Subdivider of land in the City of Kenosha shall, at the discretion and direction of the Common Council, either dedicate public and open space lands designated on the Comprehensive Plan or where no public or open space lands are dedicated, pay a public site fee. The Common Council shall, at the time of reviewing the Preliminary Plat or Certified Survey Map, select one of the following options and record such selection in the minutes of the meeting at which the Land Division is presented for approval.

1. Dedication of Site Option. Whenever a proposed park designated on the Comprehensive Plan is encompassed, all or in part, within a tract of land to be Subdivided, the public lands shall be made a part of the Plat and shall be dedicated to the public by the Subdivider. The public site shall be equal to five (5%) percent of the total net area of the Land Division.

2. Public Site Fee Option. If the Land Division does not encompass a public park, a fee for the acquisition of park land to serve the proposed Land Division shall be paid to the City Clerk/Treasurer prior to recording of the Land Division. The public site fee shall be equal to the value of the land that would have otherwise been dedicated. The value of said dedication shall be determined by the Plan Commission, as being its assessed value or its value as determined by an appraiser retained by the Plan Commission. Under no circumstances shall the public site fee be less than Two Hundred Fifty (\$250.00) Dollars for each lot within the Subdivision for park purposes. Public site fees collected by the City Clerk/Treasurer under the provisions of this Ordinance shall be placed in a nonlapsing special fund for City park acquisition and development and shall be separate from the general fund of the City.

3. Environmental Corridors and Natural Areas. The Plan Commission shall require the dedication of primary environmental corridors, secondary environmental corridors, or isolated natural areas designated on the Comprehensive Plan above and beyond the five (5%) percent dedication for public sites.

CODE OF GENERAL ORDINANCES, 2021 - KENOSHA, WISCONSIN

J. Traditional Neighborhood Development. The design standards for Land Divisions involving Traditional Neighborhood Development may be altered by the City Plan Commission and Common Council to the extent that the principles and standards of Traditional Neighborhood Development are reasonably applied. Said design standards shall be elaborated in the Development Agreement required for the Land Division.

17.10 REQUIRED IMPROVEMENTS

A. General. All Certified Survey Map or Subdivision Plat required improvements shall be constructed in accordance with plans and standard specifications approved by Director of Public Works of the City of Kenosha and the General Manager of the Kenosha Water Utility.

B. Survey Monuments. The Subdivider shall install survey monuments placed in accordance with the requirements of Chapter 236.15 of the Wisconsin Statutes.

C. Grading. After the installation of the temporary block corner monuments by the Subdivider and establishment of street grades by the City Engineer, the Subdivider shall grade the full width of the right-of-way of all streets proposed to be dedicated in accordance with plans and standard specifications approved by the Common Council, upon the recommendation of the City Engineer. The Subdivider shall grade the roadbeds in the street right-of-ways to subgrade. Cut and filled lands shall be graded to a maximum slope of one on four or the soil's angle of repose, whichever is the less, and covered with permanent vegetation.

D. Surfacing. After the installation of all utility and storm water drainage improvements, the Subdivider shall surface all roadways in streets proposed to be dedicated to the widths prescribed by City Ordinances and the Comprehensive Plan.

E. Curb and Gutter. The Subdivider shall construct concrete curb and gutters in accordance with City Ordinances and standard specifications approved by the City Engineer.

F. Sidewalks. The Subdivider shall construct a concrete sidewalk on both sides of all streets within the Land Division. Sidewalks shall be installed in accordance with the requirements of Section 5.05 of the Code of General Ordinances.

G. Public Sanitary Sewerage. The Subdivider shall construct sanitary sewerage facilities in accordance with Kenosha Water Utility rules.

H. Storm Water Drainage Facilities.

1. The Subdivider shall construct storm water drainage facilities in conformance with City Ordinances and standards approved by the City Engineer, adequate to serve the Land Division which may include, but are not limited to, curbs and gutters, catch basins and inlets, storm sewers, road ditches, open channels, water retention/detention structures and settling basins. All such facilities shall be of adequate size and grade to hydraulically accommodate volumes of flow and shall be so designed as to prevent and control soil erosion and sedimentation, and preserve water quality, designed in conformance with City criteria therefor as approved by the Public Works Committee (Board of Public Works).

2. The City Engineer may require the installation of storm water retention/detention facilities at the Subdivider's expense, designed in conformance with City criteria on storm sewers and storm water retention/detention as approved by the Public Works Committee (Board of Public Works), and on file in the Department of Public Works.

CODE OF GENERAL ORDINANCES, 2021 - KENOSHA, WISCONSIN

I. Water Supply and Distribution Facilities. The Subdivider shall install water supply and distribution facilities as required by the Kenosha Water Utility in accordance with all Kenosha Water Utility requirements and State laws, rules, regulations and Kenosha Water Utility Rules.

J. Other Utilities. The Subdivider shall accommodate other utilities to be installed in such a manner as to make adequate service available to each lot in the Land Division. Plans indicating the proposed location of all such utilities shall be approved by the City Engineer.

K. Street Lamps. Unless otherwise provided for in the Development Agreement, the Subdivider shall pay Wisconsin Electric Power Company the installation cost for public street lights per the approved lighting plan.

L. Street and Regulatory Signs and Traffic Signals. The Subdivider shall pay the City to install street and regulatory signs and traffic signals of a design approved by the Traffic Engineer and as required in the Development Agreement.

M. Street Trees. The Subdivider shall plant at least one (1) tree of a species approved by the City Forester and of at least two (2") inches in diameter measured six (6") inches above the ground on all streets to be dedicated according to the following:

1. One (1) tree for 0-119 feet of frontage.
2. Two (2) trees for 120-179 feet of frontage.
3. Three (3) trees for 180-239 feet of frontage.
4. Four (4) trees for 240-300 feet of frontage.
5. Additional trees for each sixty (60') feet of frontage over three hundred (300') feet.

The trees shall be planted within the lawn park area unless otherwise authorized by a Development Agreement. The City Forester shall mark all tree locations prior to planting. The Subdivider shall provide a guarantee to replace at the Subdivider's expense any street tree that is fifty (50%) percent dead or greater within one (1) year of planting.

In lieu of planting street trees, the Subdivider may, at the time of Final Plat approval or Certified Survey Map approval, pay a tree fee to the City Clerk/Treasurer of Four Hundred Fifty (\$450.00) Dollars for each tree to be planted. Monies collected for tree planting shall be kept in a special tree planting fund for that purpose and shall be separate from the general fund of the City. The special funds shall be used exclusively for the acquisition and planting of trees within those Land Divisions where said funds are collected.

N. Erosion Control. The Subdivider shall install all erosion control measures as required by Chapter 33 of the Code of General Ordinances.

17.11 DEVELOPMENT AGREEMENTS

A. Requirement. The approval of every Subdivision Plat and Certified Survey Map shall be conditioned upon applicant entering into a Development Agreement with the City of Kenosha and Kenosha Water Utility, which shall be recorded with the Kenosha County Register of Deeds. The Subdivider shall pay the review fee therefor established by the Common Council, from time to time, by Resolution. The Development Agreement shall be in a form drafted or approved by the City Attorney. No building or structure shall be constructed or site improvements begun within the Land Division until a Development Agreement has been approved and recorded. The Common Council may waive the Development

CODE OF GENERAL ORDINANCES, 2021 - KENOSHA, WISCONSIN

Agreement when no public improvements are required in conjunction with the Land Division. The Development Agreement shall include, but is not limited to:

1. Responsibility for Improvements. The applicant for approval of every Subdivision Plat and Certified Survey Map shall be responsible for the design, construction, and installation of all required and agreed upon improvements which serve Land Division at their full cost and expense, and for maintenance thereof unless and until accepted by the City and/or Kenosha Water Utility, in conformance with all State, City and Kenosha Water Utility laws, rules and regulations.

2. Land Dedications and Impact Fees. The Development Agreement shall provide for land dedications required by this Chapter and for such Impact Fees as are imposed under Chapter 35 of the Code of General Ordinances, with time frames for accomplishment.

3. Acceptance of Public Improvements. Public improvements which serve Land Divisions shall not be deemed dedicated for a public purpose until respectively accepted by the City and Kenosha Water Utility as being fully functional and in conformance with the Development Agreement, applicable plans and specifications, City Ordinances, and compatibility with attached and adjacent systems, facilities and improvements.

4. Assurances. The Development Agreement shall provide for an assurance as defined in Section 17.02 B., which shall guarantee the construction, installation and maintenance of improvements in compliance with the Development Agreement and this Ordinance. If the sub-divider's project will be constructed in phases the amount of any assurance required by the Development Agreement shall be limited to the phase of the project that is currently being constructed. The assurance required by the Development Agreement may not be required any sooner than is reasonably necessary before the commencement of the installation of the improvements.

5. Indemnity and Hold Harmless Agreements. With respect to storm and surface water drainage, the Development Agreement shall provide a provision, in a form drafted or approved by the City Attorney, providing that owner/developer indemnify, hold harmless and defend City, its Water Utility and their officers and employees, from and against any and all claims and liability arising out of the design and construction of any storm and surface water drainage system which causes said water to flow in full or part upon any private property.

6. Guarantees and Warranties. The City and Kenosha Water Utility shall require reasonable guarantees and warranties respecting any improvements installed or constructed by or through owner/developer.

7. Enforcement. Occupancy Permits may be withheld with respect to any parcel of property within an approved Subdivision Plat or Certified Survey Map until the Department of City Development certifies that the requirements of this Ordinance have been met. In the event any work specified in the Development Agreement is not completed in accordance with the Development Agreement and this Ordinance, the City and/or Kenosha Water Utility may do or cause said work to be done, and charge the cost thereof against any posted assurance or charge the benefited property through a special assessment where there is no applicable or insufficient assurance. Any guarantee or warranty shall remain in effect and be enforced to the full extent of the law.

17.12 CONSTRUCTION

A. Commencement. No construction or installation of improvements shall commence in a proposed Land Division until the Final Plat or Certified Survey Map and Development Agreement has been approved by the Common Council, the Development Agreement has been signed, all required assurances have been received and approved, and the Director of City Development has given written authorization to proceed. Inspection fees shall be required to be paid as specified in the Development Agreement.

CODE OF GENERAL ORDINANCES, 2021 - KENOSHA, WISCONSIN

B. Plans. The following plans and construction specifications shall be provided by the Subdivider at the Subdivider's expense, and reviewed and approved by the City Engineer and the Kenosha Water Utility General Manager before authorization of construction or installation of improvements.

1. Street plans and profiles showing existing and proposed grades, elevations and cross-sections of required improvements.
2. Sanitary sewer plans and profiles showing the locations, grades, sizes, elevations and materials of required facilities.
3. Storm sewer and storm water detention/retention plans and profiles showing the locations, grades, sizes, cross-sections, elevations and materials of required facilities.
4. Water main plans and profiles showing the locations, sizes, elevations and materials of required facilities.
5. Erosion and sedimentation control plans showing those structures required to retard the rate of runoff water and those grading and excavating practices that will prevent erosion and sedimentation. The time span that soil will be exposed, and plans to protect existing vegetation (fences, tree wells, etc.) shall be prepared and such plans shall generally follow the guidelines and standards set forth in the Wisconsin Department of Natural Resources (DNR) publication *Wisconsin Construction Site Best Management Practices Handbook*, as amended from time to time.
6. Planting plans showing the locations, age, diameter size six (6") inches above grade, and species of any required grasses, vines, shrubs and trees.
7. Grading/drainage plans showing lot and street drainage.
8. Additional special plans or information as required by the Director of City Development.

C. Building Permits.

1. No Building Permit shall be issued for a Residential Real Estate Development until the following conditions have all been met:

- a. The Land Division and Development Agreement have been approved, signed and recorded with the Kenosha County Register of Deeds.
- b. All required public improvements, including all retention/detention basins and outlet structures, must be installed and functional.
- c. The binder course of asphalt on streets and curb and gutter must be installed.
- d. The Land Division must be graded in accordance with the approved grading plan.
- e. As-built plans of all required improvements, including all retention/detention basins and outlet structures, in acceptable print and digital form must be submitted to the Department of City Development, the City Engineer, and the General Manager of the Kenosha Water Utility.

2. No Building Permit shall be issued for a Commercial Real Estate Development until the following conditions have all been met:

- a. The Land Division and Development Agreement has been approved, signed and recorded with the Kenosha County Register of Deeds.
- b. Access to the Land Division for all required inspections acceptable to the Department of City Development, the City Engineer and the General Manager of the Kenosha Water Utility must be provided.

D. Temporary Certificate of Occupancy. No Temporary Certificate of Occupancy shall be issued for a Commercial Real Estate Development until the following conditions have all been met.

1. All required public improvements must be installed and functional.
2. The Land Division must be graded in accordance with the approved grading plan.
3. As-built plans of all required public improvements in acceptable print and digital form must be submitted to the Department of City Development, the City Engineer, and the General Manager of the

CODE OF GENERAL ORDINANCES, 2021 - KENOSHA, WISCONSIN

Kenosha Water Utility.

4. All required storm water drainage facilities, including retention/detention basins and outlet structures must be installed and functional.

5. As-built plans of all required storm water drainage facilities, including retention/detention basins and outlet structures, in acceptable print and digital form must be submitted to the Department of City Development, the City Engineer, and the General Manager of the Kenosha Water Utility.

E. Inspection. The Subdivider, prior to commencing any work within the Subdivision, shall notify the City Engineer and the Kenosha Water Utility General Manager of the proposed work and to make arrangements to provide for adequate inspection. The appropriate City and Water Utility officials shall inspect and approve all completed work prior to release of the assurances for the improvements installed by the Subdivider in accordance with a Development Agreement. The Subdivider is responsible for paying all the costs of inspection.

F. As-Built Plans Required. Prior to completion and acceptance by the City and Kenosha Water Utility of all improvements, the Subdivider shall provide a copy of all of the improvement plans, as-built in print and in a digital format satisfactory to the City Engineer and Kenosha Water Utility General Manager.

17.13 FEES

A. Review and Service Fees. The Common Council shall establish fees, from time to time, by Resolution, for the following reviews and services which are provided by City Departments, Boards, Commissions, Committees, Authorities, and the Common Council:

1. Certified Survey Maps, including concept, application, resubmittals;
2. Development Agreements;
3. Document/Plat/Map/Combination recording;
4. Lot Line Adjustment Survey;
5. Parcel Combination;
6. Subdivision Plats, including concept, Preliminary Plats, Plats and Replats; and,
7. Subdivision Inspection Fees.

B. Recording Fees. It shall be the responsibility of the Subdivider to provide the recording fees in the amount required by the Register of Deeds for the purpose of recording a Subdivision, Certified Survey Map, Parcel Combination or Lot Line Adjustment Survey and any accompanying documentation required by the Review Authority.

ILLUSTRATION NO. 1
CH. 17 LAND DIVISION ORDINANCE
ILLUSTRATION OF TYPICAL CORNER,
DOUBLE FRONTAGE, FLAG, AND INTERIOR LOTS

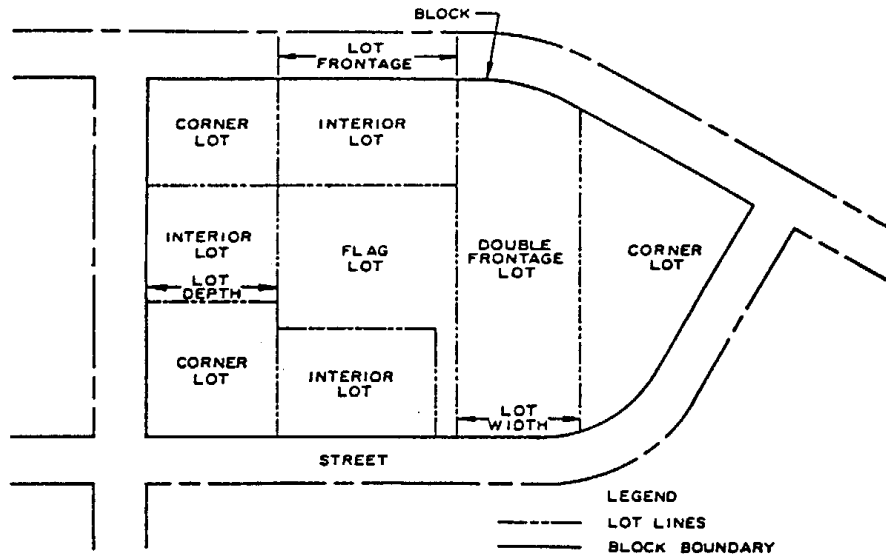

ILLUSTRATION NO. 2
CH. 17 LAND DIVISION ORDINANCE
TYPICAL STREET SYSTEM

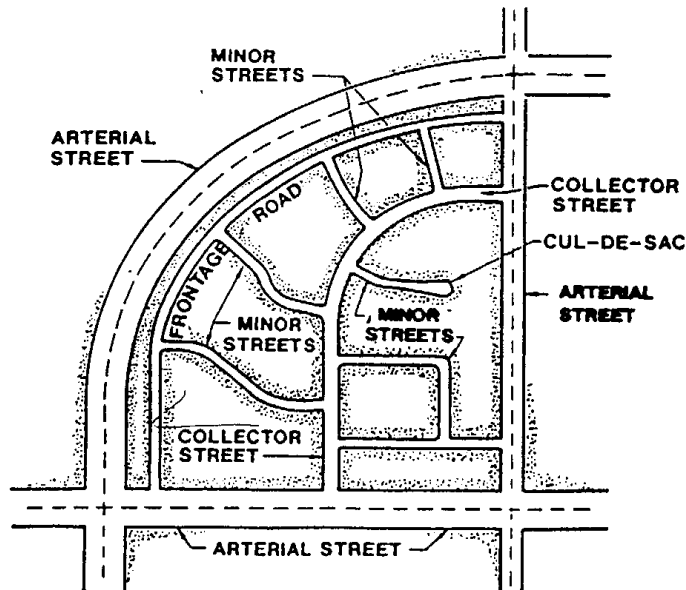

Illustration No. 3
Chapter 17 Land Division Ordinance
Typical Cul-de-Sac Design

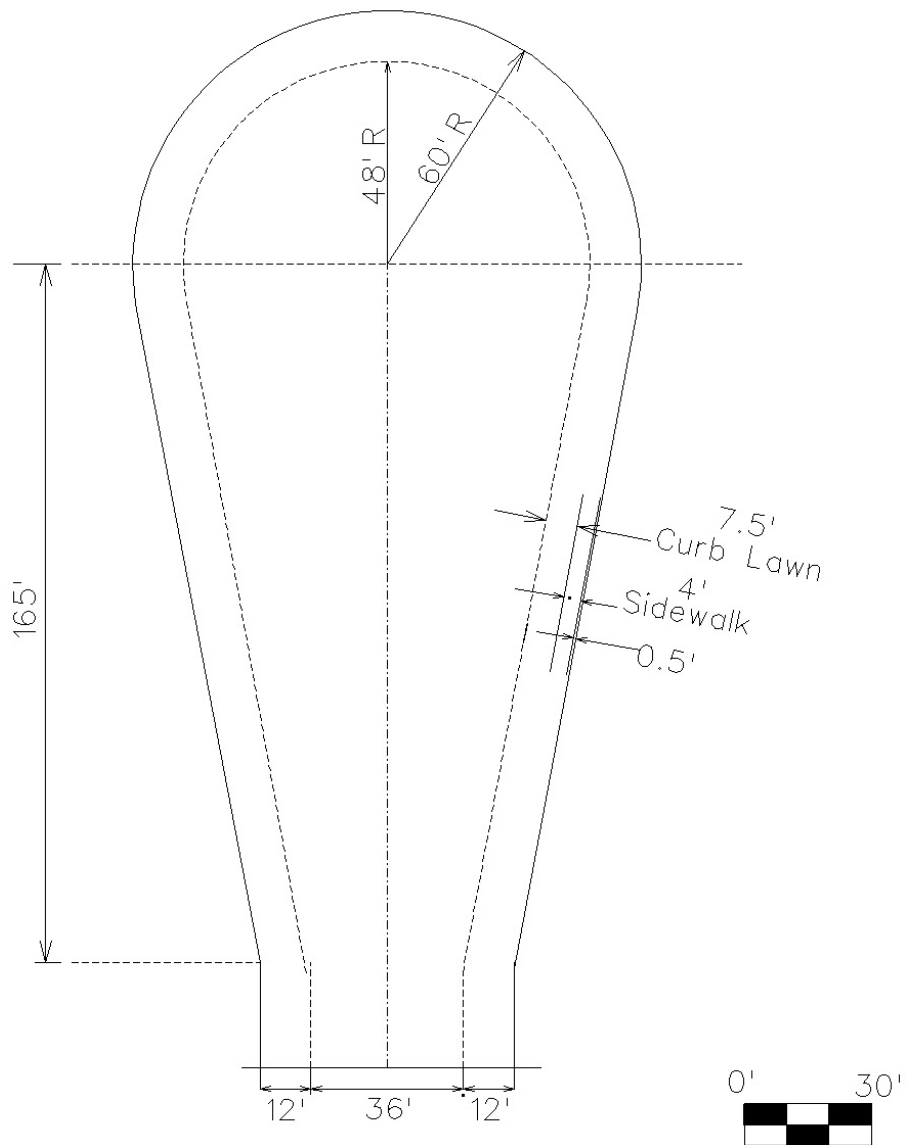
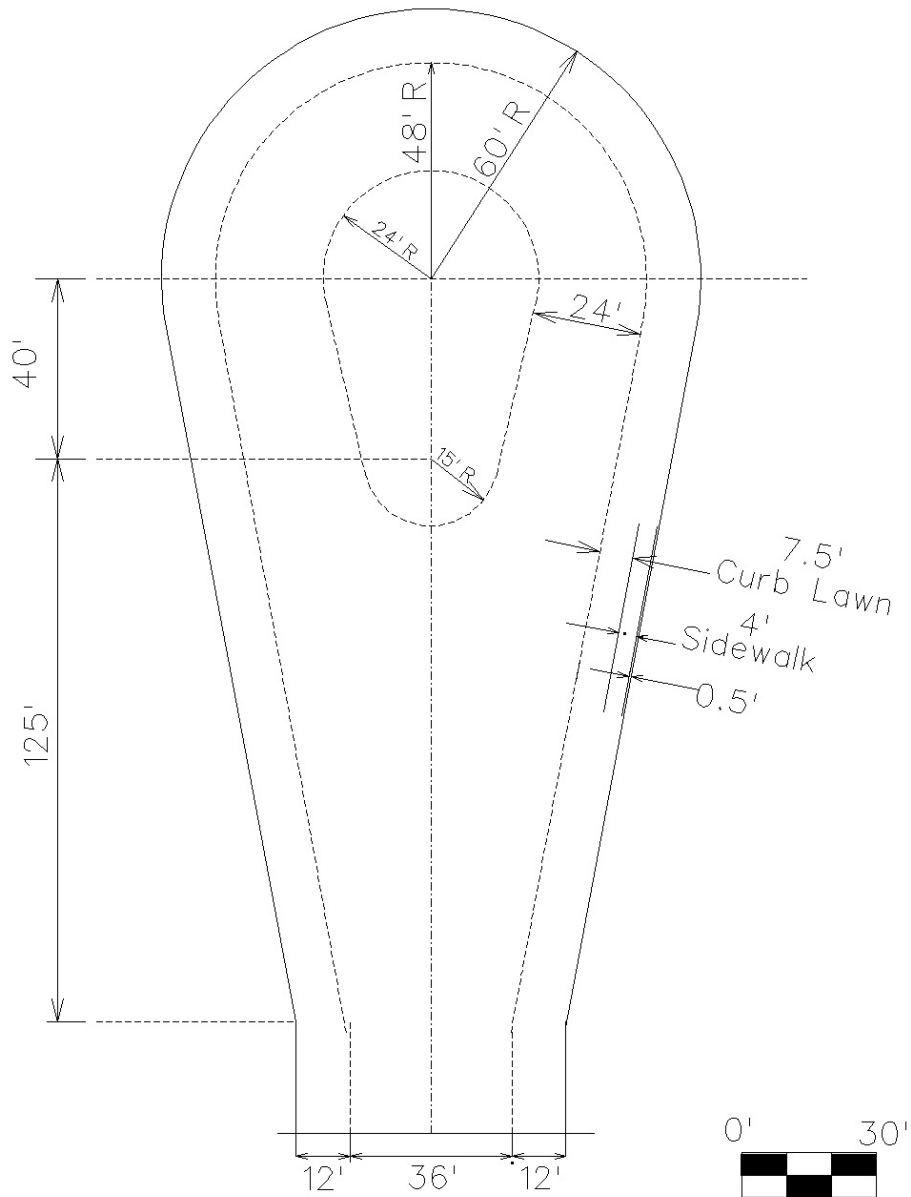

Illustration No. 4
 Chapter 17 Land Division Ordinance
 Typical Cul-de-Sac Design
 With Island



CODE OF GENERAL ORDINANCES, 2020 - KENOSHA, WISCONSIN

CHAPTER XVIII KENOSHA REGIONAL AIRPORT OPERATION AND REGULATIONS

18.01 DEFINITIONS OF WORDS AND PHRASES AS USED IN THIS ORDINANCE, UNLESS THE CONTEXT OTHERWISE REQUIRES

A. "Airport" means the Kenosha Regional Airport located in Sections 29 and 32, Town 2 North, Range 22 East of the Fourth Principal Meridian, and lying and being in the Township of Somers, County of Kenosha, and State of Wisconsin. The change in the name of the City's Airport from "Kenosha Municipal Airport" to "Kenosha Regional Airport" shall not affect or nullify any leases or agreements entered into with respect to the Kenosha Municipal Airport.

B. "Owner" means the City of Kenosha.

C. "Fixed-Base Operator" means any person, firm, corporation or association carrying persons or property for hire, or furnishing aeronautical services supplies, or instruction, and carrying on such business from a particular municipal airport.

D. "T-hangar" means a T-shaped building capable of housing one airplane.

E. "Shop" means a building capable of housing one or more aircraft while such aircraft is being repaired.

F. "Taxiway" means an area designated or used solely for the taxiing of aircraft except apron areas.

G. "Concession" means any nonaeronautical or facility service required for the convenience of the public using the airport.

H. "Runway" means any hard-surfaced area used and designed for the taking-off and landing of aircraft.

I. "Landing Strip" means any area designed and used for the landing and taking off of aircraft.

J. "Apron" means an area adjacent to the administrative and business hangar sections of the airport designed and used solely for the parking and servicing of aircraft.

K. "Tie-Down" means an area designed and used for the parking and tying down and storage of aircraft.

L. "Hangar" means any building designed and used for aeronautical purposes providing space for aircraft storage and service activities.

M. "Public Thoroughfare" means all areas located in the administration section of the airport designed and used for the passage of people in vehicle or on foot.

N. "Public Areas" means the area consisting of the commercial, municipal, and vehicle parking areas in accordance with the Zoning Maps "A" and "B" or zoning plan.

O. "Vehicle" means every device in, upon, or by which any person or property is or may be transported or drawn upon a public highway.

P. "Lessor" means owner as defined in paragraph B. of this Section.

Q. "Emergency Equipment" is defined as Ambulances, Crash Rescue and Firefighting Apparatus and such other equipment as the Airport Commission of this Council may designate as necessary to safeguard airport runways, taxiways, ramps, buildings and other property.

R. "Service, Maintenance and Construction Equipment" is equipment normally operated by the City of Kenosha and/or the Civil Aeronautics Administration on landing areas, runways, taxiways and peripheral roads for the servicing, maintenance and construction of airport facilities and services. This definition shall include equipment owned and operated by a contractor performing work on the airport under a contractual agreement with the City of Kenosha and/or its Airport Commission.

S. "Airport Hazard" means any structure, object of natural growth, or use of land which obstructs the air space required for the flight of aircraft in landing or taking off at an airport or is otherwise hazardous to such landing or taking off.

T. "Nonconforming Use" means any structure, tree or use of land which does not conform to a

CODE OF GENERAL ORDINANCES, 2020 - KENOSHA, WISCONSIN

regulation prescribed in this Ordinance or an amendment thereto, as of the effective date of such regulation.

U. "Person" means any individual, firm, partnership, corporation, company, association, joint stock association, or body politic, and includes any trustee, receiver, assignee, or other similar representative thereof.

V. "Structure" means any object constructed or installed by man.

W. "Tree" means any object of natural growth, except farm crops which are cut at least once a year, and except shrubs, bushes or plants which do not grow to a height of more than five feet.

18.02 AIRPORT COMMISSION-POWERS AND DUTIES

A. Jurisdiction of the equipment, maintenance and operation of the Kenosha Regional Airport, including the power to enter into contracts and leases, is hereby vested in Kenosha Airport Commission, subject to approval of the Common Council.

B. The Kenosha Airport Commission shall consist of five (5) members, who shall serve six (6) year terms, which terms shall expire as follows and at the conclusion of every six (6) years thereafter: April 30, 1980, 1981, 1982, 1983 and 1984. The initial terms of the expanded two (2) memberships shall commence upon appointment following passage and publication of this Ordinance and shall expire on April 30, 1981 and 1983. One (1) member of the Commission shall be an Alderman, who shall hold his/her position only in the capacity of and for so long as being an Alderman, but no longer than the appointed term as a Commissioner. The Commissioners shall serve without compensation and their allowance for expenses shall be as fixed by the Common Council. The Commissioners shall be persons especially interested in aeronautics. The Commission shall elect one (1) member Chairman at its first meeting in May of each year. The Airport Director shall act as Secretary to the Airport Commission and shall have the duty to keep an accurate record of all its proceedings and transactions. The Commission shall have the duties and responsibilities conferred upon it by State and local laws, rules and regulations.

C. The Commission is empowered to adopt regulations and establish fees or charges for the use of the airport not inconsistent with Chapter XVIII. Such regulations, fees, and charges shall not become effective until approved by the Common Council.

D. It shall be the duty of Kenosha Airport Commission to submit an annual budget to the Common Council setting forth anticipated revenues, expenditures, and the amount recommended to be raised by taxation for airport purposes.

E. All the provisions of Chapter 114 of the Wisconsin Statutes, particularly §114.14, are hereby adopted as far as practicable as if set forth in full here.

18.03 AIRPORT DEVELOPMENT CODE

A. Airport Development Map. The airport development areas of the airport are hereby regulated in accordance with the "Airport Development Map - Kenosha Municipal Airport, Kenosha, Wisconsin", dated November 15, 1985, which is made a part of this Ordinance and incorporated herein by reference. All activities, operations, functions and land uses within the airport development areas established by the "Airport Development Map" shall conform to the regulations set forth in the following subsections.

Boundaries of the airport development areas shall be construed to follow: corporate limits; airport property lines; right-of-way lines of streets, highways or easements or such lines extended; airport building restriction lines; and lot or property lines, unless otherwise noted on the "Airport Development Map".

B. Airport Development Areas.

1. Municipal Area.

a. Permitted uses-this area shall be the public use area and shall be developed by the airport owner. Facilities needed for the public shall be located there.

b. Minimum lot-none.

c. Minimum building setbacks-none.

2. Commercial Aviation Area.

a. Permitted uses, provided such uses have approved leases and contracts under the provisions of this Chapter:

(1) Fixed-base operator, including all normal commercial aviation activities such as: sale, maintenance, and repair of aircraft, engines, parts, and accessories; sale of fuel and oil; flight training; aircraft rentals and charter services.

(2) Aircraft sales, maintenance and repair.

(3) Aircraft accessory parts and services, including avionics installation and repair.

(4) Automobile rental agencies.

(5) Commercial uses directly related to the airport operations, limited to restaurants, cocktail lounges and snack shops.

(6) Vocational and technical aviation training centers and educational facilities.

b. Minimum lot area-Commercial aviation operators shall meet the minimum standards of Chapter 25 of the Code of General Ordinances. Other listed commercial uses shall meet the minimum standards of the City Zoning Ordinance.

c. Minimum building setbacks-ten (10') feet from the front, side and rear lot lines.

3. Commercial and Industrial Aviation Area.

a. Permitted uses, provided such uses have approved leases and contracts under the provisions of this Chapter:

(1) Aircraft sales, maintenance and repair.

(2) Aircraft accessory parts and service, including avionics installation and repair.

(3) Air freight facilities.

(4) Airport service industries requiring direct access to aircraft, taxiways and the airport.

(5) Automobile rental agencies.

(6) Corporate aircraft hangars.

(7) Corporate offices and research, engineering and light production facilities requiring direct access to aircraft, taxiways and the airport, and, which are of the non-nuisance type.

(8) Warehouse and distribution facilities requiring direct access to aircraft, taxiways and the airport, and, which are of the non-nuisance type.

b. Minimum lot area-lots shall be a minimum of eight thousand (8,000) square feet in area and shall not be less than eighty (80') feet in width, or shall meet the minimum standards of Chapter 25 of the Code of General Ordinances, whichever is more restrictive.

c. Minimum building setbacks-ten (10') feet from the front, side and rear lot lines.

4. T-Hangar Area.

a. Permitted uses - this area shall be restricted to the location of multiple or single-unit T-hangars for the storage of privately owned aircraft on lots with approved leases under the provisions of this Chapter. Only individual owners may personally perform maintenance or repairs on their own aircraft in this area. No inflammable liquids shall be stored above or below the ground. Aircraft shall be stored or packed in hangars at all times unless the owner or pilot is in close proximity to the aircraft.

b. Minimum lot area - lots shall not be less than seventy-six (76') feet in width and the depth will be

CODE OF GENERAL ORDINANCES, 2020 - KENOSHA, WISCONSIN

determined by the type of hangar and number of units, or, shall meet the minimum standards of **Chapter 25** of the Code of General Ordinances, whichever is more restrictive.

c. Minimum building setbacks - ten (10') feet from the front and rear lot lines, and a minimum of seven and one-half (7-1/2') feet from side lot lines.

5. Prohibited Uses. To protect the Kenosha Regional Airport by avoiding incompatible uses of land and activities, the following uses and activities are not permitted within any airport development area:

a. Any residential, institutional or any other use of land which may be susceptible to being adversely affected by aircraft generated noise, as defined by Federal Aviation Administration (FAA) policies and regulations.

b. Any use of land which creates electrical interferences with radio or microwave communications between the airport and aircraft, or make it difficult for pilots to distinguish between airport lights and other lights, or result in glare in the eyes of pilots using the airport, or impair visibility in the vicinity of the airport or otherwise endanger the landing, taking off or maneuvering of aircraft, including the activities of any of the above permitted uses which may interfere with access to taxiways, aprons or runways.

c. Any use of land or construction activity that would encourage the concentration of bird (avian) populations.

18.04 BUILDINGS

A. City Buildings. The City, through its Airport Commission, may construct such buildings at the Kenosha Regional Airport as the Airport Commission deems necessary and convenient to airport users, lessees, frequenters and the general public which are budgeted for by the Common Council.

B. Building Construction. All buildings constructed by the City, or by any person, party, firm or corporation, shall comply with all applicable Federal, State and City laws, rules and regulations, with Kenosha Regional Airport Minimum Standards and with the Airport Master Plan. The Airport Commission shall have the authority to regulate the types, height, design and construction of any building to be constructed at the Kenosha Regional Airport, to approve the plans and specifications therefor, and to require obstruction lights, and regulatory and warning signs, to be installed.

C. Ownership Of Improvements. The Airport Commission may, through lease, determine ownership of improvements, upon completion or upon lease termination, constructed at the Kenosha Regional Airport.

18.05 LEASES, CONCESSIONS AND CONTRACTS FOR USE OF LAND

A. Rentals, Fees, and Charges. The amount to be charged as rent or fees for the use of the airport, or any part thereof, shall be fixed by Common Council with the advice of the Airport Commission.

B. Terms. The duration of any lease or contract involving the Airport shall be determined by the Common Council with the advice of the Airport Commission.

C. Non-Aviation Concessions. The right to operate non-aviation concessions in commercial areas and public areas is prohibited unless expressly authorized in the lease approved by the Common Council.

D. Execution of Leases and Contracts. All leases and contracts when approved by the Common Council shall be executed by the Mayor and City Clerk for and on behalf of the City.

E. Selection of Lessees. Airport lessees shall be selected on the basis of desirability, and the owner shall not be limited to accept the highest bidder.

F. Utilities.

1. **Electricity**-Lessees desiring electrical power for purposes other than those assumed by the lessor shall pay for all costs involved in acquiring electricity from the available source, and shall have separate meters from those of the lessor. Location of lines and poles shall be approved by the Commission.

2. **Water**-The Commission shall have the option of allowing lessees to obtain a water supply from the administration building well or to have lessee install his own well on his leased premises. Lessee in either case shall pay for all costs involved.

3. **Sewer Facilities**-The location for all cesspools and dry wells constructed on the airport shall be approved by the Commission.

18.06 REGULATIONS OF VEHICULAR TRAFFIC

A. Operation of Vehicles on Runways, Taxiways, and Ramps. No privately owned vehicle shall enter, be driven upon or operated upon any airport runway, taxiway, ramp, tie-down area, or any area posted by signs prohibiting the entrance thereon.

The provisions of this Section shall not apply to Emergency Equipment and/or service, maintenance and construction equipment when engaged in performing official duties.

Aircraft owners will be excluded from the provisions of this Section, relating to tie-down areas, when necessary to reach their own aircraft, but in doing so they shall not pass over any runway, taxiway, or ramp and shall proceed through said tie-down area at a speed not to exceed 10 miles per hour. They shall not at any time park a vehicle on any area used for the movement of aircraft.

B. Speed of Vehicles. No vehicle shall be driven upon any road within the perimeter of the Kenosha Regional Airport, or upon other Airport area in excess of the speed limit posted at the entrance of said Airport or within the boundaries thereof if more than one speed limit be applicable. Nor shall the driver of any vehicle fail to adhere to any sign posted to regulate vehicular traffic on or about Kenosha Regional Airport for the public safety.

C. Pedestrian Traffic On Airport. No pedestrian shall be allowed beyond the administration area onto the apron or aircraft tie-down area unless for the purpose of embarking in or disembarking from an aircraft, or unless authorized by the Airport Director. Pedestrian traffic is prohibited in the runway and outlying area of the Airport except for those employees of the City, County, State, Federal Government, or contractors engaged in airport construction or maintenance work.

D. Any person who shall violate any of the provisions of 18.06 shall upon conviction thereof forfeit not less than One (\$1.00) Dollar, nor more than Five Hundred (\$500.00) Dollars, together with the cost of prosecution, or in default of payment of the forfeiture and costs of prosecution shall be imprisoned in the County Jail until said forfeiture and costs are paid, but not exceeding six months.

18.065 PERSONAL PROPERTY STORAGE

A. Definition.

1. **"Personal Property"** shall mean any trailer, watercraft, camper, snowmobile, all terrain vehicle, motorcycle, any other motor vehicle, irrespective of operating condition or license status, and any other property not attached to a building or the ground, excluding motor vehicles used to service aircraft.

2. **"Storage"** shall mean Personal Property kept on premises outside of a building for two (2) or more full consecutive days.

B. Outdoor Storage. No person, party, firm or corporation, whether a Lessee or otherwise, shall store or cause to be stored any Personal Property outside of any building located at Kenosha Regional

Airport.

18.07 REGULATION OF AIRCRAFT OPERATIONS

A. Definitions.

1. Within the meaning of this Section, "**aircraft**" is defined to be any contrivance now known or hereafter invented, used or designed for navigation or for flight in the air, except a parachute or other contrivance designed for such navigation and used primarily as safety equipment.

2. Within the meaning of this Section, "**acrobatic flying**" shall mean any intentional maneuvers not necessary to air navigation.

B. Operators of Aircraft to be Licensed. Operators of aircraft and aircraft operating within or over the limits of the City of Kenosha shall be duly licensed according to applicable regulations of the United States and the Federal Aviation Administration.

C. Height at Which Aircraft to be Operated. No person shall operate any aircraft within the jurisdiction of the City of Kenosha except at a height to be in compliance with Federal Aviation Administration regulations. Helicopters may be flown at less than the minimum altitude prescribed herein if such operations are conducted without hazard to persons or property on the surface, and at an altitude which will permit, in the event of the failure of a power unit, an emergency landing without undue hazard to persons or property on the surface. Permission to fly at less than minimum altitude or to land helicopters within the City of Kenosha must be secured from the Chief of Police before such operations are conducted. Permission may only be granted if both the operator and the aircraft are licensed as specified in Subsection B. hereof, and insured as required under the terms of said licenses. In the interest of safety, the Chief of Police of the City of Kenosha, in conjunction with the Airport Director, may prescribe specific routes, altitudes, and landing areas for such operations; in which event helicopters shall conform thereto. Permission to use a City park may not be granted by the Chief of Police if such activity is thereby prohibited by Ordinance or if the permission of the Park Commission has not been obtained in advance.

D. Acrobatic Flying Prohibited. No person shall operate an aircraft in acrobatic flying over any portion of the City of Kenosha.

E. Operation of Aircraft Subject to Regulations of the Department of Transportation, Federal Aviation Administration. No person shall operate any aircraft over or within the City of Kenosha in violation of any rule or regulation which has been or may hereafter be established by the Department of Transportation of the United States (Aviation Act of 1958, as amended, 49 U.S.C.A., Section 1301-1542) Federal Aviation Administration, or the State of Wisconsin, Chapter 114 of the Wisconsin Statutes.

F. Waivers. Should the Federal Aviation Administration provide a specific waiver of Federal Aviation Regulations which have the same intent as contained in this Ordinance the City of Kenosha may, upon request, similarly waive the pertinent paragraph(s) or section(s) of this Ordinance.

G. Hot-Air Balloons. Nothing in this Section shall be construed to prohibit the launching of hot-air balloons within the jurisdiction of the City of Kenosha by persons operating under a permit issued by the Chief of Police of the City of Kenosha. The Chief of Police shall consult with the Airport Director prior to the issuance of a permit. Application for such permit shall be made by letter to the Chief of Police not less than twenty (20) days before the proposed operation of the balloon. Such letter shall specify the place of takeoff, the names of the operators, and the numbers and expiration dates of the Federal Aviation Administration licenses of the operators and of the balloons, accompanied by a permit fee of Ten (\$10.00) Dollars for each balloon. An organized balloon rally, upon written request, may receive a waiver of the permit fee. A permit for a balloon rally shall not become effective unless and until a certificate of liability

CODE OF GENERAL ORDINANCES, 2020 - KENOSHA, WISCONSIN

insurance is filed with the Chief of Police indicating that the applicant is insured by an insurance company licensed to do business in the State of Wisconsin in the amounts of \$1,000,000 per injury and per occurrence for death or personal injury, and \$250,000 for property damage, with the City of Kenosha being named insured. Permission to use a City park may not be granted by the Chief of Police if such activity is otherwise prohibited by Ordinance or if the permission of the Park Commission has not been obtained in advance.

H. Dropping of Objects from Aircraft Prohibited. No person in an aircraft shall cause or permit to be thrown out, discharged or dropped within the City, any object or thing, except loose water or loose sand ballast when absolutely essential to the safety of the occupants of the aircraft; and all equipment, baggage, and articles of personal property carried in an aircraft, shall be adequately fastened in place before leaving the ground.

18.08 HEIGHT LIMITATION-AIRPORT APPROACH PROTECTION. SEE SECTION 2.05 OF THE ZONING ORDINANCE

18.09 ORDINANCE ENFORCEMENT

A. Airport Director. The Airport Director shall administer and enforce all provisions of Chapters 4, 7, 11, 18, 20, 23 and 25 of the Code of General Ordinances at the Kenosha Regional Airport and may issue citations for violations thereof pursuant to Section 66.0113(2), Wisconsin Statutes. Said administration and enforcement shall be exclusive with respect to Chapters 18 and 25 and nonexclusive with respect to Chapters 4, 7, 11, 20 and 23.

B. Obstruction. No person may willfully hinder, obstruct, or otherwise interfere with the Airport Director in the administration and enforcement of Chapters 4, 7, 11, 18, 20, 23 and 25 of the Code of General Ordinances at the Kenosha Regional Airport.

C. Responsibility of Lessees. No Lessee shall directly or indirectly violate, authorize the violation of, or permit the violation of Chapters 4, 7, 11, 18, 20, 23 and 25 of the Code of General Ordinances at or over the Kenosha Regional Airport. For purposes of this Section, Lessee shall mean any person who has leased any land, building or structure from an owner/lessor at the Kenosha Regional Airport. The term shall also include aircraft tiedown tenants.

18.10 PENALTIES

Any person, firm, party, corporation or organization found guilty of a violation of any provision of this Chapter shall, upon conviction thereof, be required to forfeit the sum of not less than Twenty-five (\$25.00) Dollars, nor more than One Thousand (\$1,000.00) Dollars, together with the costs of prosecution and applicable assessments and surcharges, and in default of payment thereof, shall be either imprisoned until such forfeiture and costs are paid, but for a period not to exceed thirty (30) days, or have their driver's license suspended, where applicable, for a period of up to five (5) years.

Each and every calendar day each violation shall continue, except as otherwise provided in this Chapter, shall constitute a separate offense.

CHAPTER XIX
KENOSHA MUNICIPAL HARBOR OPERATION AND REGULATIONS

19.01 BOARD OF HARBOR COMMISSIONERS

The Board of Harbor Commissioners of the City of Kenosha is created and shall have all the powers, rights, and duties as conferred upon such boards by Chapter 30 of the Wisconsin Statutes.

19.011 COMMERCIAL HARBOR, SIMMONS ISLAND MARINA, SAILBOAT BASIN, SOUTHPORT MARINA

A. Descriptions.

1. **"COMMERCIAL HARBOR"** is described as a portion of the navigable waterway, known by the U.S. Army Corps of Engineers on November 1, 1989, as the "Kenosha Harbor", said portion being the waterway between the North and South piers and the turning basin immediately North of the Western extreme of the South pier. The COMMERCIAL HARBOR shall specifically exclude property contiguous to the waterway, said exclusion specifically including, but not limited to, the property occupied on November 1, 1989, by the Kenosha Yacht Club and the North pier warehouse.

2. **"SAILBOAT BASIN"** is described as the portion of navigable waters of Kenosha Harbor between 50th Street and 51st Place running approximately sixty (60) feet along the East Side of the Kenosha Harbor immediately South of the location of the U.S. Coast Guard Station as of November 1, 1989, specifically excluding the property occupied by the Kenosha Yacht Club.

3. **"SIMMONS ISLAND MARINA"** is described as the portion of the navigable waterway known as the Kenosha Harbor and related facilities appurtenant thereto; said portion of the waterway is bounded on the North by 45th Street, on the South by the 50th Street Bridge, on the East by Simmons Island Park, and on the West by private land; said "related facilities" shall specifically include the dockage and parking facilities directly abutting said portion, the launch ramps, the public fish cleaning station and its facilities; said SIMMONS ISLAND MARINA specifically excludes the area of land occupied on November 1, 1989 by the Kenosha Yacht Club.

4. **"SOUTHPORT MARINA"** is described as being roughly bounded by 57th Street on the North, by 60th Street on the South and by 3rd Avenue on the West.

B. Jurisdiction.

1. The Harbor Commission shall have jurisdiction over the COMMERCIAL HARBOR and establish rates for services, in accordance with Chapter 30, Wisconsin Statutes, and all other applicable laws. The Department of Public Works shall provide administrative assistance to the Harbor Commission.

2. The Common Council of the City of Kenosha shall have jurisdiction over the SOUTHPORT MARINA, SIMMONS ISLAND MARINA and SAILBOAT BASIN and related facilities, and all land contiguous to the navigable waterway known as the Kenosha Harbor not specifically reserved to the Harbor Commission, in accordance with City Ordinances and Wisconsin Statutes.

The Department of Public Works, under the supervision of the Park Commission, shall be charged with the responsibility of preparing the Operating and Capital Improvement Budgets for said facilities. The Marina Commission shall review said Budgets and forward its recommendations to the Board of Park Commissioners, who shall make its recommendations and forward them to the Committee on Finance for

CODE OF GENERAL ORDINANCES, 2020 - KENOSHA, WISCONSIN

further review and recommendation prior to submission to the Common Council for approval. The Common Council shall act upon the recommendation of the Marina Commission.

With respect to Public Works projects and improvements relative to any said facility, the Committee on Public Works (Board of Public Works) shall have such authority as provided by City Ordinances and State Law.

19.015 MARINA COMMISSION

A. Title and Purpose. There is hereby created the MARINA COMMISSION, whose purpose is to act in an advisory capacity with respect to the Southport Marina, Simmons Island Marina and the Sailboat Basin, when operated by the City and, if operated under a lease or licensing agreement, to perform such duties as required thereby.

B. Composition and Term. The MARINA COMMISSION shall be the Board of Harbor Commissioners. The members shall hold office for so long as holding the position from which appointed.

C. Officers. The Commission shall elect a Chairman and Vice-Chairman on May 1 of each year.

D. Duties. The MARINA COMMISSION shall make recommendations to the Park Commission and other reviewing and approving bodies with respect to:

1. Capital Improvements, including requests for proposals and contracts.
2. Annual budget.
3. Operation.
4. Promotion and marketing.

The Marina Commission shall also perform any duties required under a lease or licensing agreement if any such facility is operated under a lease or licensing agreement.

E. Committees. The Commission may appoint Committees to negotiate contracts, review requests for proposals or make recommendations with respect to other matters within its jurisdiction.

19.02 REGULATION OF BOATING

A. Except as otherwise specifically provided in this Ordinance, all provisions of Sections 30.50 through 30.71, Wisconsin Statutes of 1991-1992, describing and defining Boating Regulations, and also all amendments thereof and supplementary thereto, are hereby adopted and by reference made a part of this Ordinance as if fully set forth therein. Any action required to be performed or prohibited by any statute incorporated herein by reference is required or prohibited by this Ordinance.

Sections 30.50 through 30.71, Wisconsin Statutes, adopted by reference, shall include, but not be limited to the following:

- 30.50** (Definitions)
- 30.61** (Lighting Equipment)
- 30.62** (Other Equipment)
- 30.63** (Motor Boat Prohibition)
- 30.64** (Patrol Boats)
- 30.65** (Traffic Rules)
- 30.66** (Speed Restrictions/Slow No Wake Speed)
- 30.67** (Accidents: Duty to Render Aid/Duty to Report)

CODE OF GENERAL ORDINANCES, 2020 - KENOSHA, WISCONSIN

30.675 (Distress Signal Flag)

30.68 (Prohibited Operation)

30.681 (Intoxicated Boating)

30.69 (Water Skiing)

30.70 (Skin Diving)

B. The Department of Public Works shall place and maintain a copy of this Section of the Ordinance at all public access points within the jurisdiction of the City of Kenosha.

19.025 WATERWAYS DESIGNATED SLOW-NO-WAKE

A. Definitions.

1. "Personal Watercraft" means a motorboat that uses an inboard motor powering, a water jet pump or a caged propeller as its primary source of motive power, and that is designed to be operated by a person standing on, kneeling on or sitting astride the watercraft.

2. "Slow-No-Wake" means that speed at which a boat moves as slowly as possible while still maintaining steerage control.

B. No person shall, at any time, operate a boat or personal watercraft faster than "Slow-No-Wake" within the navigable waterways of the Simmons Island Marina, Sailboat Basin, Commercial Harbor and Southport Marina.

19.03 PUBLICIZING LOCAL REGULATIONS

All local regulations adopted under §30.77 (3) of the Wisconsin Statutes shall be prominently posted by the Board of Harbor Commissioners, acting for the Common Council, at all public access points within the harbor area, and also shall be filed with the State Conservation Commission.

19.04 BULKHEAD LINE

The Common Council of the City of Kenosha, establishes in the public interest a bulkhead line along a portion of the shore of Lake Michigan in the City of Kenosha, Kenosha County, Wisconsin pursuant to Section 30.11(3), Wis. Stats. The bulkhead line of the shore of Lake Michigan is established and determined to be:

A line lying in Sections 5 and 8, Township 1 North, Range 23 East - Kenosha County, Wisconsin in City of Kenosha, Wisconsin described as follows:

Commencing at a concrete monument with brass cap at the Southeast Corner of Section 6, Township 1 North, Range 23 East, said point also being the Southwest Corner of Section 5, Township 1 North, Range 23 East; thence North 89 degrees, 27 minutes, 38 seconds East along the South line of Southwest Quarter of said Section 5, a distance of 859.98 feet more or less to a concrete monument with brass cap at the Meander Corner; thence South 00 degrees, 00 minutes, 00 seconds East a distance of 1419.04 feet; thence North 90 degrees, 00 minutes, 00 seconds East a distance of 320.94 feet to the Point of Beginning; thence North 07 degrees, 10 minutes, 30 seconds West a distance of 39.61 feet; thence North 50 degrees, 40 minutes, 30 seconds West a distance of 84.49 feet; thence North 12 degrees, 01 minutes, 27 seconds West a distance of 270.81 feet; thence North 05 degrees, 59 minutes, 56 seconds West a distance of 146.57 feet; thence North 16 degrees, 44 minutes, 55 seconds West a distance of 170.80 feet; thence North 01 degrees, 36 minutes, 12 seconds West a distance of 271.58 feet; thence North 06 degrees, 23 minutes, 57 seconds West a distance of 223.21 feet; thence North 03 degrees, 55 minutes, 18 seconds East a distance of 114.26 feet; thence North 05 degrees, 37 minutes, 39 seconds East a distance of 99.61 feet; thence North 01 degrees,

CODE OF GENERAL ORDINANCES, 2020 - KENOSHA, WISCONSIN

48 minutes, 21 seconds West a distance of 141.54 feet; thence North 10 degrees, 20 minutes, 27 seconds West a distance of 164.57 feet; thence North 07 degrees, 15 minutes, 35 seconds West a distance of 166.23 feet; thence North 01 degrees, 06 minutes, 08 seconds West a distance of 261.90 feet; thence North 03 degrees, 52 minutes, 22 seconds West a distance of 403.66 feet; thence North 19 degrees, 48 minutes, 37 seconds West a distance of 291.74 feet; thence North 71 degrees, 06 minutes, 49 seconds East a distance of 51.52 feet; thence North 02 degrees, 56 minutes, 11 seconds West a distance of 61.84 feet; thence North 00 degrees, 00 minutes, 00 seconds East more or less to a point on the South Line of Lot 8 of the Lakewood Subdivision, said point is the Point of Ending.

The metes-and-bounds description above from POB to POE describes the bulkhead line of fill placement associated with the 2019 Kenosha Harbor Dredging Project.

Bearings are referenced to the south line of the southwest quarter of Section 5, Township 1 North, Range 23 East, Kenosha County, Wisconsin Assumed to Bear North 89 degrees, 27 minutes, 38 seconds East. The bulkhead line described herein is more particularly shown on the map found at Appendix 19.04 of this Ordinance.

19.045 PIERHEAD LINE, PENALTY FOR VIOLATIONS

No person, party, firm or corporation shall violate any pierhead line established by the City under authority of §30.13, Wisconsin Statutes. The penalty for such a violation, upon convictions, shall be a forfeiture of not less than Twenty-Five (\$25.00) Dollars and not more than One Hundred (\$100.00) Dollars per day of violation, plus Court costs, each day constituting a separate violation, and in default of payment of said forfeiture and Court costs the violator shall be imprisoned in the County Jail for not more than sixty (60) days.

19.05 LOCAL REGULATIONS

A. Sanitary.

1. No person, firm or corporation shall throw, discharge, dump, deposit, or cause or permit to be thrown discharged, dumped or deposited any garbage, filth, offal or putrid or unwholesome substance upon the margin or banks or within the limits or into the waters of the harbor.

2. No person, firm or corporation shall throw, discharge, dump, deposit or cause to be thrown, discharged, dumped or deposited any clay, earth, ashes, stone, timber, rubbish, junk or similar substance in the harbor unless said matter shall be placed inside of an improved retaining wall so arranged as not to permit the escape of such substance into the waters of the harbor.

3. No master or other person in charge or in possession of any vessel while entering or leaving the harbor or while anchored, moored or tied up at any wharf, pier or revetment, shall discharge, dump, deposit or cause or permit to be discharged, dumped, or deposited any residue of any cargo within the limits or into the waters of the harbor.

B. Health.

1. **Rat Guards.** Immediately after moving alongside any dock or wharf, all ocean vessels must put approved rat guards on all lines leading to the dock or wharf.

C. Safety.

1. **Cargo Gear and Gangway Safety Inspection Certificate.** Masters are required to present safety inspection certificate of cargo handling equipment and gangways to stevedoring companies and other employers of harbor labor upon request.

2. **Shipside Projections.** All ocean vessels while docked must have gangways, booms or other projections on the off shore side of the vessel rigged in within the line of the ship's side except when working lighters, barges, or trimming with self unloader boom, etc., on the off shore side.

3. Dangerous Cargo Handling. Vessels bunkering fuel oil or handling other inflammables and/or explosives in the Dangerous Cargo Regulations of the U.S. Coast Guard while in the harbor shall fly the International Code Flag "B" by day and show a red light by night in customary manner.

D. Fire.

1. No open fire is permitted on deck of any vessel while in the harbor.
2. In the event of fire occurring on board any vessel in the harbor, such vessel must sound five (5) prolonged blasts of the whistle or siren as an alarm indicating fire on board or at the dock at which the vessel is moored. Such signal must be repeated at intervals to attract attention and is not a substitute for, but must be used in addition to the usual means of reporting fire to the local Fire Department. The words "prolonged blast" shall mean a blast from 4 to 6 seconds duration.

E. Miscellaneous.

1. Splash Boards. Immediately after mooring alongside a dock, where required by dock facility, suitable splash boards must be installed and secured over any waste lines on the dock side of the ship to prevent any discharge from going over the dock surface.

2. Responsible Ship's Officers. All vessels while in the harbor must have at least one officer on board in authority who shall take action as may be necessary in case of an emergency.

When loading, vessels shall maintain appropriate officers and crews aboard to permit shifting of vessels and reception of cargo at any time of day or night.

3. Cargo Manifests. It shall be the responsibility of each commercial vessel or its agents, fishing tugs excepted, to furnish to the Kenosha Board of Harbor Commissioners a copy of the manifest on all inbound or outbound cargo being discharged or loaded at this port.

19.055 OBSTRUCTIONS TO NAVIGATION IN HARBOR

A. Authority. This Ordinance is created pursuant to the authority of §30.16, Wisconsin Statutes and other applicable law.

B. Prohibition. No person, party, firm or corporation shall permit any watercraft or float to obstruct or interfere with the free navigation of any water channel or slip in the harbor, nor, more specifically permit any watercraft or float to be placed, tied anchored or moored in the Small Boat Harbor beyond the pierhead line established by the City on the West side of said harbor in the water channel separating private piers and slips on the West side of the harbor from City piers and slips on the East side of said harbor.

C. Removal. The Harbor Master, or designee thereof, may remove any watercraft or float found to be violating §B., after having given reasonable notice to the master or owner or agent, if known and a resident of this State, or to the person in charge thereof, to so remove such watercraft or float.

D. Costs of Removal. All costs, charges and expenses of such removal are a first lien on such watercraft or float, which lien may be enforced in the manner provided by law. The owner of any such watercraft or float is also personally liable for such costs, charges and expenses, to be recovered by the City by a personal action commenced by the City Attorney.

E. Penalty. Any person, party, firm or corporation violating this Ordinance shall, upon conviction thereof, forfeit not less than Twenty-Five (\$25.00) nor more than Five Hundred (\$500.00) Dollars, each day of violation constituting a separate offense together with the costs of prosecution and in default of payment of forfeiture and costs of prosecution shall be imprisoned in the County Jail for not more than ninety (90) days.

19.06 BOAT LAUNCHING AND MOORING IN THE SIMMONS ISLAND MARINA

A. Boat Launching and Mooring Fees. Boat launching and mooring fees shall be established by the Common Council, following review and recommendation by the Marina Commission and Park Commission.

B. Prohibition. Within the Simmons Island Marina, no person shall:

1. Launch a boat without first obtaining a permit from the City through the Parks Division, or its designated contractor, issued upon payment of an appropriate fee established by the Common Council.
2. Moor a boat in any boat mooring slip without first having entered into a seasonal or temporary slip rental/lease agreement with the City through the Parks Division, or its designated contractor, and paying an appropriate fee established by the Common Council.
3. Launch or moor a boat contrary to this Chapter or reasonable order or direction of enforcing personnel.

C. Enforcement. This Section shall be enforced by the Department of Public Works, or its designated contractor. The Director of the Department shall designate employees thereof, or its designated contractor, to enforce this Section, hereinafter referred to as enforcing personnel. The requirements of this Chapter shall be posted, in summary form, at the land entrance to the Simmons Island Marina.

D. Removing and Impounding Boats Moored in an Unauthorized Boat Slip. Enforcing personnel are authorized to remove and impound any boat moored in an unauthorized boat slip until payment is received for such mooring based upon the Temporary Slip Rental fee then in effect for the size of subject boat, plus a Fifty (\$50.00) Dollar service fee. The person who paid the fees shall be notified of their right to appeal.

The person who paid such fees may, within ten (10) days following payment, file a written notice of appeal with the Department of Public Works, which appeal shall be heard by the Marina Commission within a reasonable time, who shall give the recommendation to the Park Commission. The Park Commission may uphold the fee or direct that the fee be refunded where collected contrary to this Section or where otherwise required in the interest of justice.

19.07 SECRETARY

The Board of Harbor Commissioners shall employ a secretary, not a member of the Board, and fix his compensation and duties. His appointment shall be made pursuant to the Civil Service Ordinance of the City of Kenosha (§30.07(5), Wis. Stats.).

19.08 HARBOR MASTER

A. The Board of Harbor Commissioners shall employ a Harbor Master and fix his compensation. His appointment shall be made pursuant to the Civil Service Ordinance of the City of Kenosha (§30.07 (5) Wis. Stats.).

B. Duties and Powers. The Harbor Master is authorized and required to give such orders and directions, relative to the location, change of place or station, manner of moving in or the use of the harbor of every vessel, craft or float, lying, moving or laid up in the harbor, as may be necessary to promote good order therein and the safety and equal convenience of such vessels, crafts or floats; and any owner, master or other person having charge of the same who shall refuse to obey any such order or direction shall be punished by a fine hereinafter provided in this Chapter.

19.10 PENALTIES

A. Any person, firm or corporation violating any of the provisions of this Chapter, which provisions are in conformity with the Statutes of the State of Wisconsin, shall upon conviction thereof, be subjected to the same fine as provided by Chapter 30 of said Wisconsin Statutes and the same imprisonment only in case the fine is not paid.

B. Any person, party, firm or corporation violating any other provision of this Chapter, or reasonable order or direction of the Harbor Master, or enforcing personnel shall, upon conviction thereof, forfeit not more than Five Hundred (\$500.00) Dollars, together with the costs of prosecution, and in default of timely payment of forfeiture and costs of prosecution shall be imprisoned in the County Jail until such forfeitures and costs are paid, but for a period not exceeding thirty (30) days.

CODE OF GENERAL ORDINANCES, 2020 - KENOSHA, WISCONSIN

CHAPTER XX MANUFACTURED/MOBILE HOME PARK

20.01 DEFINITIONS

As used in this Ordinance, the following terms shall have the meanings hereinafter designated:

1. **"Complete Bathroom Facilities"** means a flush toilet, lavatory, bath and kitchen sink.
2. **"Licensee"** means any person, firm or corporation licensed to operate and maintain a manufactured home park under this Ordinance.
3. **"Lot"** is a space as defined in Subsection 12. of this Section.
4. **"Manufactured/Mobile Home"** is that which is, or was as originally constructed, designed to be transported by any motor vehicle upon a public highway and designed, equipped and used primarily for sleeping, eating and living quarters, or is intended to be so used; and includes an addition, attachments, annexes, foundations and appurtenances that equal or exceed fifty (50%) percent of the assessable value of the manufactured home.
5. **"Manufactured/Mobile Home Park"** means any plot or plots of ground upon which two (2) or more units, occupied for dwelling or sleeping purposes are located, regardless of whether or not a charge is made for such accommodation. As used in this Ordinance, Manufactured/Mobile Home Park is limited to plots on which are located two (2) or more nondependent manufactured homes.
6. **"Manufactured/Mobile Home Stand"** means that part of an individual space which has been reserved and improved for the placement of one (1) Manufactured/Mobile Home unit.
7. **"Nondependent Manufactured Home"** means a Manufactured Home equipped with completed bath and toilet facilities, furniture, cooking, heating appliances and complete year-round facilities.
8. **"Occupied Area"** means that portion of an individual Manufactured/Mobile Home space which is covered by a Manufactured/Mobile Home and its accessory structures.
9. **"Park"** means Manufactured/Mobile Home Park.
10. **"Park Management"** means the person who owns or has charge, care or control of the Manufactured/Mobile Home Park.
11. **"Person"** means any natural individual, firm, trust, partnership, association or corporation.
12. **"Space"** means plot of ground within a Manufactured/Mobile Home Park designated for the accommodation of one (1) Manufactured/Mobile Home unit.
13. **"Unit"** means a Manufactured/Mobile Home unit.

20.02 PARKING OUTSIDE LICENSED MANUFACTURED/MOBILE HOME PARK RESTRICTED

A. No person shall park, locate or place any Manufactured/Mobile Home outside of a licensed Manufactured/Mobile Home Park in the City of Kenosha, except unoccupied Manufactured/Mobile Homes may be parked on the lawfully situated premises of a licensed Manufactured/Mobile Home dealer for purposes of display; the lawfully situated premises of a vehicle service business for purposes of servicing or making necessary repairs; the premises leased or owned of such Manufactured/Mobile Home for purposes of sales display for a period not to exceed one hundred twenty (120) days, provided no business is carried on therein.

B. No person shall stop, stand or park a Manufactured/Mobile Home on any street, alley or highway within the City of Kenosha in violation of Chapters 340 to 348 of the Wisconsin Statutes, or the Ordinances and regulations of the City of Kenosha.

20.03 MANUFACTURED/MOBILE HOME PARK CONDITIONAL USE PERMIT

A. Manufactured/Mobile Home Park Conditional Use Permit Required. No person, party, firm or corporation shall construct or expand any Manufactured/Mobile Home Park without first securing a

CODE OF GENERAL ORDINANCES, 2020 - KENOSHA, WISCONSIN

Conditional Use Permit therefor from the City Common Council. Expansion shall be defined as the adding of additional Manufactured/Mobile Home Park "spaces", as herein defined, over and above the number of spaces already licensed by the City. Expanded portions of existing Manufactured/Mobile Home Parks must meet the full requirements of this Ordinance, but the original portion of the Manufactured/Mobile Home Park need only meet the local and State laws, rules, regulations and ordinances which governed said Park prior to the Park coming into the City by annexation or otherwise which governed said Park prior to the adoption of the Ordinance. Modifications of Manufactured/Mobile Home Parks in existence prior to this Ordinance or coming into the City by annexation or attachment which are not an "expansion", as herein defined, are permitted providing the minimum standards in effect prior to the passage of the Ordinance which governed said Manufactured/Mobile Home Park are maintained. Application for a Conditional Use Permit shall be made in conformance with the procedures of Section 4.0 of the City of Kenosha Zoning Ordinance.

B. Manufactured/Mobile Home Park Conditional Use Permit Application. Applications for Manufactured/Mobile Home Park Conditional Use Permits shall be filed with the Department of City Development with sufficient copies for the Kenosha County Health Administrator, and various City Departments, all who shall investigate and report if the application complies with all applicable regulations and submit a written report of their findings to the City Plan Commission. The City Plan Commission shall review the application and respective City Department reports to determine whether the applicant, the premises on which said Park will be located and the proposed design and specifications thereof and all buildings proposed to be constructed thereon will comply with the applicable regulations, Ordinances and laws of the State and City and report their findings in writing and make a recommendation to the Common Council within sixty (60) days. The Commission's recommendation shall be considered by the Common Council before any permit is issued hereunder.

C. Manufactured/Mobile Home Park Conditional Use Permit Application Format. Applications shall be made on forms furnished by the Department of City Development and shall include the following information:

1. Name and address of the applicant.
2. Location and legal description of the proposed Park or Park addition.
3. A complete plot plan showing compliance with all applicable provisions of this Ordinance and the City Zoning Ordinance.
4. Complete engineering plans and specifications, including a scale drawing of the proposed Park showing but not limited to:
 - a. Plans and specifications of all utilities, including: sewerage collection and disposal, storm water drainage, water, natural gas and electrical distribution and supply, refuse storage and collection, lighting, telephone, TV antenna and cable systems, and snow removal.
 - b. Location and width of roadways and walkways, buffer strips, recreational and their common areas.
 - c. The location of Manufactured/Mobile Home Stands with the Manufactured/Mobile Home spaces, including a detailed sketch of at least one typical Manufactured/Mobile Home space and stand therein.
 - d. Landscape plan showing all plantings.
 - e. Plans and specifications of all Park buildings and structures.

D. Manufactured/Mobile Home Park Conditional Use Permit Application Fee. Application for Manufactured/Mobile Home Park Conditional Use Permits shall be accompanied by the fee specified in the City Zoning Ordinance to cover the cost of investigation and processing, plus regular Building Permit fees for all buildings or structures to be erected within the proposed Park.

E. Ownership Interest Of An Applicant In A Proposed Manufactured/Mobile Home Park Or Extension Thereof. If the owner of a tract is a person other than applicant, a duly verified statement by the owner that applicant is authorized by him/her to construct and maintain the proposed Park addition, modification or extension and make the application.

20.04 STANDARD REQUIREMENTS FOR MANUFACTURED/MOBILE HOME PARKS, ADDITIONS OR EXTENSIONS

A. Standard Requirements. All Manufactured/Mobile Home Parks or additions or extensions to existing Parks shall comply with the following:

1. Chapters ATCP 125, COMM 82, COMM 51, COMM 95 and PSC 186, Wisconsin Administrative Code, are hereby made a part of this Ordinance and incorporated herein by reference as if fully set forth herein, except that such regulations shall not be deemed to modify any requirement of this Ordinance or any other applicable law or ordinances of the State or the City which is more restrictive.
2. New Manufactured/Mobile Home Parks shall contain a minimum of six (6) acres.
3. The maximum number of Manufactured/Mobile Home spaces shall be eight (8) per acre and individual spaces shall be not less than 3,400 square feet in area and arranged to afford ample area for a variety of units, a setback of thirty-five (35') feet from all public right-of-ways and ten (10') feet from any Park drive or common area, including common parking areas, twenty (20') feet from all Park boundary lines, fifteen (15') feet from any other unit, building or structure. Accessory structures, such as awnings, cabanas, carports, windbreaks or attached porches shall be considered part of the unit for purposes of determining compliance with this provision. No building or structure, nor the enlargement of any building or structure shall exceed thirty-five (35') feet in height, except for those structures authorized in the general provisions and regulations of the City Zoning Ordinance to exceed this height limit.
4. No Manufactured/Mobile Home Park shall be laid out, constructed or operated without City water supply and sanitary sewer service. All water or sanitary sewerage facilities in any unit not connected with public water or sewer systems by approved pipe connections shall be sealed and their use declared unlawful.
5. Individual valved water service connections shall be provided for direct use of each unit, so constructed and installed that they will not be damaged by frost or parking of the unit. Water systems shall be adequate to provide a pure, potable water supply of 6 gallons per minute at a minimum pressure of 20 psi and capable of furnishing a minimum of 150 gallons per unit per day. Fire hydrants shall be installed within five hundred (500') feet of every Manufactured/Mobile Home Stand and Park building.

Where these standards do not apply due to the fact that the Manufactured/Mobile Home court was in existence prior to this Ordinance or was annexed to the City, the Fire Chief may order the Licensee to install fire hydrants within five hundred (500') feet of every Manufactured/Mobile Home Stand and Park building and provide that said order be complied with within two (2) years, where in his discretion and opinion fire protection cannot otherwise be adequately provided.
6. All liquid wastes originating at units, service or other buildings shall be discharged into a sewerage system. Such system shall comply with all provisions of the State Code and City Ordinances relating to plumbing and sanitation, with a continuous grade, which is not subject to surface drainage, so constructed that it can be closed when not in use and seal-capped in such a manner that it can be kept odor free.
7. Adequate provisions shall be made for the disposal of solid and liquid wastes in a manner approved by the Kenosha Water Utility and the Fire Chief. Open burning of waste or refuse is prohibited.
8. Distribution system shall be new and all parts and installations shall comply with all applicable Federal, State and local codes.
9. A minimum of two (2) off-street parking spaces surfaced with bituminous concrete, or similar material capable of carrying a wheel load of 3,000 pounds shall be provided for each mobile home space for new areas.
10. Condition of soil, ground water level, drainage and topography shall not create hazards to the property, health or safety of occupants of Manufactured/Mobile Home spaces or living units. The site shall not be exposed to objectionable smoke, noise, odors or other adverse influences, and no portion subject to unpredictable and/or sudden flooding, subsidence or erosion shall be used for any purpose which would expose persons or property within or without the Park to hazards.
11. Exposed ground surfaces in all parts of every Manufactured/Mobile Home Park shall be protected with a vegetative growth that is capable of preventing soil erosion and elimination of objectionable dust.
12. The ground surface in all parts of every Manufactured/Mobile Home Park shall be graded and

CODE OF GENERAL ORDINANCES, 2020 - KENOSHA, WISCONSIN

equipped to drain all surface water in a safe, sanitary and efficient manner.

13. All Parks shall be furnished with lighting so spaced and equipped with luminaries placed at such heights as will provide the following average maintained levels of illumination for the safe movement of pedestrians and vehicles at night:

a. All parts of the Park street systems: 0.6 footcandles, with a minimum of 0.1 footcandles.

b. Potentially hazardous locations, such as major Park street intersections and steps or stepped ramps, individually illuminated, with a minimum of 0.3 footcandles.

14. All Manufactured/Mobile Home spaces shall abut a paved street. Widths of streets shall be in accordance with COMM 95.09, Wisconsin Administrative Code. All streets shall be paved and well drained under normal use and weather conditions for the area. Grades of streets shall be sufficient to insure adequate surface drainage, but not more than eight (8%) percent, provided a maximum grade of twelve (12%) percent may be used if approved by the Director of Public Works as safe and designed to avoid traffic hazards. Streets shall be approximately right angles within one hundred (100') feet of an intersection. Intersections of more than two streets at one point shall not be allowed. A distance of at least one hundred fifty (150') feet shall be maintained between center lines of offset intersecting streets.

15. All Parks shall be provided with paved pedestrian walks between individual mobile homes, Park streets and community facilities of not less than five (5') feet in width.

16. All Manufactured/Mobile Home Parks shall have a greenbelt or buffer strip not less than fifteen (15') feet wide along all boundaries and shall be landscaped in accordance with Section 14 of the Zoning Ordinance.

17. All Manufactured/Mobile Home Parks shall be assessed a Park/Open Space Impact Fee per lot with respect to Chapter XXXV, entitled "Impact Fees".

18. All Manufactured/Mobile Home Parks shall be provided with safe and convenient vehicular access from abutting public streets or roads to each mobile home space. Entrances to Parks shall be designed to minimize congestion and traffic hazards and allow free movement of traffic on adjacent streets.

19. The standards and requirements for Manufactured/Mobile Home Park design, layout and development contained in this Section are intended to be minimum standards necessary to create a safe, sanitary, healthful, agreeable and urbane environment in Manufactured/Mobile Homes and Manufactured/Mobile Home Parks and the City of Kenosha. The express enumeration of such standards shall not preclude the governing body by resolution or by law, or through express written agreement with the Manufactured/Mobile Home Park owner or developer, or by authority of the conditional use review procedures established in the City Zoning Ordinance from imposing modifications of or addition to the requirements of this Ordinance. The governing body shall only modify or add to such requirements when it is determined that such modifications or additions are more likely to achieve the purpose of this Section than those set forth herein and will not conflict with applicable laws of the State.

B. Exceptions. These standards do not apply to mobile home courts which have been in existence and operation prior to the passage of this Ordinance or brought into the City by annexation or attachment after the effective date of this Ordinance, but shall apply to the expanded portions thereof. However, **Section 20.04 A.5..** relative to the installation of fire hydrants shall apply to otherwise exempt Manufactured/Mobile Home Parks where the Fire Chief has issued an order for compliance therewith.

C. Approved Comparable Construction. When strict adherence with this Ordinance appears to be impractical and satisfactory proof is provided to the Department of City Development and the Department of City Inspections, it may approve modifications as needed to safeguard public health, safety and welfare.

20.05 MANUFACTURED/MOBILE HOME PARK OPERATORS LICENSE

A. License Required. No person shall operate, administer or maintain a Manufactured/Mobile Home Park within the City of Kenosha without a valid, unexpired Manufactured/Mobile Home Park License issued by the City Clerk/Treasurer and approved by the governing body upon determination that the

CODE OF GENERAL ORDINANCES, 2020 - KENOSHA, WISCONSIN

standards in this Section have been met and payment of the required fee.

B. License Term. Manufactured/Mobile Home Park Licenses shall be issued for a calendar year and shall expire on June 30 of the next succeeding date of issue. Licenses may be issued after July 1, of any year but no rebate or diminution of the fee shall be allowed therefor.

C. License Fee. The fee for a Manufactured/Mobile Home Park License shall be One Hundred (\$100.00) Dollars for each fifty (50) Manufactured/Mobile Home spaces or fraction thereof. Licenses may be transferred during a license year for a fee of Ten (\$10.00) Dollars.

D. License Subject to Revocation/Suspension. Licenses granted under this Section shall be subject to revocation or suspension by the governing body for cause in accordance with §66.0435(2), Wisconsin Statutes. "**Cause**" as used in this subsection shall include, but not be limited to:

1. Failure or neglect to abide by the requirements of this Ordinance or the laws or regulations of the State of Wisconsin relating to Manufactured/Mobile Home Parks and their operation.

2. Conviction of any offense under the laws of the State or Ordinances of the City relating to fraudulent or misleading advertising or deceptive practices regarding the sale or renting of Manufactured/Mobile Homes or the leasing or rental of Manufactured/Mobile Home spaces or sale, lease or operation of Park facilities.

3. Operation or maintenance of the Manufactured/Mobile Home Park in a manner inimical to the health, safety or welfare of Park occupants or the inhabitants of the City of Kenosha including, but not limited to, repeated violations of laws or ordinances related to health, sanitation, refuse disposal, fire hazards, morals or nuisances.

4. Transfer or sale of an ownership interest in any Manufactured/Mobile Home space or the underlying land other than to another eligible Licensee. Such action shall also subject the owner of the underlying land to all requirements of the State and municipal subdivision control laws and regulations regardless of the size or number of lots or spaces so transferred or sold.

E. Manufactured/Mobile Home Park License Standards. Manufactured/Mobile Home Park Licenses shall be granted subject to the following standards:

1. Compliance with State and local laws, rules, regulations and ordinances.

2. Manufactured/Mobile Home Parks shall be used only for the parking and occupancy of single-family nondependent Manufactured/Mobile Homes and accessory structures, appurtenances and uses herein authorized.

3. Compliance with City Zoning Laws and procurement of any permits affecting land use which may be required.

4. Report from City Inspections, Health and Fire Departments indicating compliance with local and State laws, rules and regulations.

F. Monthly Parking Fee.

1. There is hereby imposed on each owner of a nonexempt Manufactured/Mobile Home in the City, a monthly Parking Permit fee determined in accordance with Section 66.0435(3), Wisconsin Statutes. It shall be the full and complete responsibility of the Manufactured/Mobile Home Licensee to collect the proper amount from each Manufactured/Mobile Home owner or occupant. Licensees and owners/occupants of Manufactured/Mobile Homes permitted to be located on land outside a Manufactured/Mobile Home Park, and the owners of land on which such homes are parked, shall pay to the City Clerk/Treasurer such Parking Permit fees on or before the 10th day of the month following the month for which such fees are due in accordance with the terms of this Ordinance and such reasonable regulations as the City Clerk/Treasurer may promulgate.

2. Licensees hereunder and owners of land on which are parked any Manufactured/Mobile Homes, shall inform the City Clerk/Treasurer and City Assessor of such Manufactured/Mobile Homes as are added to their Parks or lands within five (5) days after the arrival of such Manufactured/Mobile Homes on

CODE OF GENERAL ORDINANCES, 2020 - KENOSHA, WISCONSIN

forms prescribed by the Department of Revenue in accordance with Section 66.0435(3)(c) 2, Wisconsin Statutes.

3. Manufactured/Mobile Home Park Operators who collect the heretofore provided monthly parking fee for the City may deduct for their administrative expenses, two (2%) percent of the monthly parking fees collected.

G. Manufactured/Mobile Home Park Exemptions. Manufactured/Mobile Home Parks in existence prior to the passage of this Ordinance or brought into the City through annexation after the effective date of this Ordinance are exempt as herein provided from certain requirements of this Ordinance, but they shall continue to comply with the minimum standards which otherwise regulated and governed said Manufactured/Mobile Home Park.

20.06 BUILDING, ELECTRICAL, PLUMBING AND HVAC REQUIREMENTS

A. Scope. The provisions of this Section of the Ordinance apply to all installations occurring on or after the effective date of this Ordinance.

B. Responsibility. It shall be the responsibility of the Licensee to assure that all requirements of this Ordinance are adhered to.

C. Notification of Violation. The Licensee shall be notified of any and all violations. Notice shall include timelines for completion of violation correction(s). Failure to correct violations and receive approval of corrections shall be cause to withhold issuance or renewal of a Manufactured/Mobile Home Park License.

D. Design and Installation Requirements.

1. No person or firm shall erect, alter or add to any Manufactured/Mobile Home, deck, ramp, porch, carport, etc., without first obtaining the proper permits and approvals. Standards and Codes shall be those adopted in **Chapter 9** of this Ordinance.

2. No building or structure shall exceed thirty-five (35') feet in height, except for those structures authorized in the general provisions and regulations of the City Zoning Ordinance.

3. No accessory building shall exceed the height of sixteen (16') feet.

4. For the purposes of this Section, "**property line**" shall mean the perimeter of the legal Manufactured/Mobile Home space.

5. Additions to existing Manufactured/Mobile Home units shall not exceed the property line, and in no case shall be located closer than fifteen (15') feet to the next nearest unit.

6. Accessory structures shall conform with the following:

a. Garages, sheds, utility buildings, etc., shall be designed to maintain a minimum two (2) foot setback from the property line, but in no case be located any closer than five (5') feet to any Manufactured/Mobile Home unit.

b. Carports shall be open on three (3) sides and may extend to the property line, but in no case be located any closer than five (5') feet to the next adjoining Manufactured/Mobile Home unit. Gutters and downspouts shall be installed to prevent storm water runoff onto adjoining property.

c. Attached porches and decks may extend from the Manufactured/Mobile Home unit, but in no case shall exceed the property line or be closer than ten (10') feet to an adjoining Manufactured/Mobile Home unit.

20.07 PROPERTY MAINTENANCE REQUIREMENTS

A. Maintenance Standards. All Manufactured/Mobile Homes and Manufactured/Mobile Home

CODE OF GENERAL ORDINANCES, 2020 - KENOSHA, WISCONSIN

Parks shall comply with the property maintenance standards set forth in **Chapter 16** of the Code of General Ordinances.

B. Operation/Maintenance of Manufactured/Mobile Home Parks. The Licensee shall operate and maintain the Park in compliance with this Ordinance and the regulations and Ordinances of the City.

The Licensee/responsible person shall:

1. Maintain an office upon Park premises, in which a copy of the Manufactured/Mobile Home Park License and a copy of this Chapter shall be prominently displayed.
2. Keep a register of all Park occupants to be open at all times to inspections by municipal officers, which shall show the names and addresses of all owners and occupants of each Manufactured/Mobile Home.
3. Notify Park occupants of the provisions of this Ordinance and inform them of their duties and responsibilities, and report promptly to the proper authorities any violations of this Ordinance or any other violations of law which may come to their attention.
4. Allow inspections of Park premises and facilities at reasonable times by municipal officials or their agents or employees.
5. Supervise placement, securing stability and installation of all utility connections of each Manufactured/Mobile Home placed in the Park.
6. Maintain the Manufactured/Mobile Home Park free of litter, rubbish and other flammable materials.
7. Provide portable fire extinguishers of a type approved by the Fire Chief in any Park building used by the public.
8. Have the Fire Chief designate every area within the Park a fire lane to be kept free and clear of obstructions.

C. Responsibility of Park Occupants. Park occupants shall:

1. Comply with all applicable requirements of this Ordinance and regulations issued hereunder, and shall maintain their Manufactured/Mobile Home space, its facilities and equipment in good repair and in a clean and sanitary condition.
2. Provide Licensee/responsible person access to any part of such Park or Manufactured/Mobile Home premises at reasonable times for the purpose of making inspections necessary to effect compliance with this Ordinance, or any law or ordinance of the State or municipality, or lawful regulations or orders adopted thereunder.
3. Park Manufactured/Mobile Homes only on Manufactured/Mobile Home Stands provided and shall be placed thereon in accordance with all requirements of this Ordinance.
4. Not conduct in any unit or Manufactured/Mobile Home Park any business or engage in any other activity which would not be permitted by the use regulations of the City Zoning Ordinance.
5. Not discharge any waste water on the surface of the ground within any Manufactured/Mobile Home Park.
6. Not erect or place upon any Manufactured/Mobile Home space any permanent or temporary structure intended to be used for dwelling purposes or in connection with any Manufactured/Mobile Home unit, except as specifically authorized by this Chapter.

D. Public Nuisance. Wrecked, damaged or dilapidated homes shall not be kept or stored in a Manufactured/Mobile Home Park or upon any premises in the City. The Code Official shall determine if a Manufactured/Mobile Home is damaged or dilapidated to a point which makes it unfit for human occupancy. Such Manufactured/Mobile Homes are hereby declared to be a public nuisance. Whenever the Code Official so determines, he/she shall notify the responsible person in writing that such public nuisance exists within the Park or on lands owned by him/her, giving the findings upon which his/her determination is based, and shall order such home removed from the Park or site or repaired to a safe,

sanitary and wholesome condition of occupancy within a reasonable time.

E. Inspection. The Code Official is authorized and directed to inspect Manufactured/Mobile Home Parks not less than once in every forty-eight (48) month period to determine compliance with this Ordinance.

20.08 PENALTIES

A. Violation Penalties. Any person who shall violate a provision of this Ordinance, shall, upon conviction, be subject to a forfeiture of not more than One Thousand (\$1,000.00) Dollars; and, in addition shall pay the costs and expenses of prosecution. Each day such violation continues shall be considered a separate offense. Failure to promptly pay said forfeiture shall subject the violator to be sentenced to the County Jail for a period not to exceed sixty (60) days.

B. Abatement of Violation. The imposition of the penalties herein prescribed shall not preclude the City Attorney from instituting appropriate action to restrain, correct or abate a violation, or to prevent illegal occupancy of a structure or premise, or to stop an illegal act, conduct business or utilization of the structure or premise.

CHAPTER XXI CONSUMER PROTECTION AND
WEIGHTS AND MEASURES

21.001 FEDERAL STANDARDS, STATE STATUTES AND RULES ADOPTED BY REFERENCE

The following Federal standards, Wisconsin Statutes and sections thereof, and Wisconsin Rules are adopted by reference and shall be enforced under this Ordinance with violations of same subject to penalties set forth in §21.34 of this Ordinance:

A. Chapter 98, Wisconsin Statutes, "Weights and Measures".

B. Chapter Ag 53, Wisconsin Administrative Code, "Packaging and Labeling".

C. Chapter Ag 54, Wisconsin Administrative Code, "Method of Sale of Commodities".

D. Sections of Chapter 100, Wisconsin Statutes, pertaining to advertising as follows: 100.18(6) and (8) "Fraudulent Advertising" and 100.183 "Fraud, Advertising Foods", and 100.184 "Advertising Foods for Sale".

E. National Bureau of Standards (NBS) Handbook 44, U.S. Department of Commerce, "Specifications, Tolerances and Other Technical Requirements for Commercial Weighing and Measuring Devices".

21.01 MEANING OF TERMS

When used in this Chapter:

A. The term "**commodity in package form**" shall be defined as in §Ag 53.02, Wisconsin Administrative Code.

B. The term "**Health Department Administrator or his agent**" shall be construed to mean a sealer of weights and measure of the City.

C. "**Incorrect**" as applied to weights and measures and commodities includes any failure to comply with the requirements of this Chapter or rules issued thereunder.

D. The term "**intrastate commerce**" shall be construed to mean any and all commerce or trade that is begun, carried on and completed wholly within the limits of the State of Wisconsin, and the phrase "introduced into intrastate commerce" shall be construed to define the time and place at which the first sale and delivery of a commodity is made within the State, the delivery being made either directly to the purchaser or to a common carrier for shipment to the purchaser.

E. The word "**person**" shall be construed to mean both the plural and singular, as the case demands, and shall include individuals, partnerships, corporations, companies, societies, and associations.

F. "**Sell**", "**sale**" and "**sold**" include barter or exchange, and any offering or exposing for sale or possession with intent to sell.

G. The term "**vending machine**" shall be construed to mean a device designed to be released for service by the insertion of money to make deliveries of a product or service. Parking meters are hereby specifically excepted from this definition.

H. "**Weight**" means net weight when used in reference to a commodity.

I. "**Weights and Measures**" means weights and measures of every kind, instruments and devices for weighing and measuring, and any appliances and accessories used with any or all such instruments and devices, except meters for the measurement of electricity, gas (natural and manufactured) or water when the same are operated in a public utility system.

21.02 SYSTEMS OF WEIGHTS AND MEASURES

The system of weights and measures in customary use in the United States and the metric system of weights and measures are jointly recognized, and one or the other of these systems shall be used for all commercial purposes in the City of Kenosha. The definitions of basic units of weight and measures, the tables of weight and measures, and weights and measures equivalents, as published by the National Bureau of Standards, are recognized and shall govern weighing and measuring equipment and transactions in the City.

21.03 DEFINITIONS OF SPECIAL UNITS OF MEASURE

The term "**Barrel**", when used in connection with fermented liquor, shall mean a unit of 31 gallons. The term "**ton**" shall mean a unit of 2,000 pounds avoirdupois weight. The term "**cord**" when used in connection with wood intended for fuel purposes, shall mean the amount of wood that is contained in a space of 128 cubic feet when the wood is ranked and well stowed.

21.04 FIELD STANDARDS AND EQUIPMENT

A. There shall be supplied by the City such "field standards" and such equipment as may be found necessary to carry out the provisions of this Chapter. The field standards shall be verified by the State weights and measures office upon their initial receipt and at least once each five (5) years thereafter.

B. The specifications, tolerances and regulations for commercial weighing and measuring devices issued by the National Bureau of Standards shall apply in this City except as modified by rules issued by the State Department of Agriculture.

21.05 GENERAL POWERS AND DUTIES OF SEALER

The Health Department Administrator, or his or her agent, shall have the custody of the City standards of weight and measure and of the other standards and equipment provided for by this Chapter, and shall keep accurate records of the same. The Health Department Administrator, or his or her agent, shall enforce the provisions of this Chapter and of the State Weights and Measures Act. He or she shall have and keep a general supervision over the weights and measures offered for sale, sold, or in use in the City. He or she shall annually make to the Wisconsin Department of Agriculture a report on all of the activities of his or her office as required by law.

21.06 WEIGHING AND MEASURING DEVICE LICENSE

A. Definitions. "**Commercial Weighing**" and "**Measuring Devices**" shall mean devices used or employed in establishing the size, quantity, extent, area or measurement of quantities, things, produce or articles for sale, hire or award, or in computing any basic charge or payment for services rendered on the basis of weight or measure.

B. License Required. No person, party, firm or corporation shall operate or maintain weights and measures, weighing or measuring devices and systems and accessories relating thereto which are used commercially within the City in determining the weight, measure or count of commodities or things sold or offered or exposed for sale on the basis of weight, measure or count unless licensed by a weighing or measuring device license issued pursuant to the provisions of this Ordinance.

C. License Application. The application for a weighing or measuring device license shall be made in writing on a form provided for such purpose by the Health Administrator. Such application shall state the

CODE OF GENERAL ORDINANCES, 2020 - KENOSHA, WISCONSIN

type and number of weighing and measuring devices to be licensed, the location of the devices, the applicant's full name and post office address and whether such person is an individual, firm or corporation and if a partnership, the names of partners together with their addresses and the signatures of the applicant or applicants.

D. License Issuance, Term & Fees. The Health Administrator shall issue a license to the applicant for the period July 1 through June 30 based on the total number of weighing and measuring devices operated by the applicant if the requirements of this Ordinance have been complied with upon payment to the City Treasurer of the fee required in the following fee schedule:

- 1. Scales 0-30 pounds \$20 per scale
- 2. Scales over 30 pounds..... \$30 per scale
- 3. Scales, Farmer's Market. \$10 per scale
- 4. Fuel Pumps\$20 per pump
- 5. Fuel Truck Meter. \$45 per meter
- 6. Late Renewal Fee. \$10

E. Suspension for Nonrenewal. It shall be the duty of the Health Administrator to notify the appropriate City officials and to order the immediate enforcement of the provisions of this Ordinance in cases involving failure to renew a weighing or measuring device license. Said licensee shall be prohibited from operating or maintaining a weighing or measuring device until such time as a valid license has been applied for and obtained under the provisions of this Ordinance.

F. Display Of License. All persons licensed under the provisions of this Ordinance shall immediately post their license upon such conspicuous part of the premises on which the business is carried on and the same shall remain posted during the period for which the license is in force.

G. Suspension of Licenses. Notwithstanding the other provisions of this Ordinance, whenever the Health Administrator finds that any licensed premises is conducted or managed in such a manner that there are serious or repeated violations of this Ordinance or violation of any of the Ordinances or regulations of the City, the laws of the State of Wisconsin or regulations of the National Bureau of Standards relating to weights and measure, he/she may, without warning, notice or hearing, issue a written notice to the license holder, operator or employee in charge of the licensed premises citing such condition and specifying the corrective action to be taken and if deemed necessary such order shall state that the license is immediately suspended and all weighing and measuring operations are to be discontinued. Any person to whom such an order is issued shall comply immediately, but upon written petition to the Health Administrator, shall be afforded a hearing before the Licensing/Permit Committee within twenty (20) days of such petition. Failure to allow an inspector immediate access to the premises to determine whether such grounds exist shall also be grounds for suspension.

H. Revocation of Licenses. For serious or repeated violations of any of the requirements of this Ordinance, or for interference with the Health Administrator, or designees thereof in the performance of their duties, the license may be permanently revoked after an opportunity for a hearing has been made by the Licensing/Permit Committee prior to such action, the Health Administrator shall notify the license holder in writing, stating the reasons for which the license is subject to revocation, and advising that the license shall be permanently revoked at the end of five (5) days following the service of such notice, unless a request for a hearing is filed with the Health Administrator, by the license holder within such five (5) day period.

I. Hearings. The hearings provided for in this Section shall be conducted by the Licensing/Permit Committee at a time and place designated by it. Based upon the record of such hearing, the Health Administrator shall be charged with enforcing the decisions of the board. A written report of the hearing decision shall be furnished to the license holder by the Health Administrator.

J. Other Weighing or Measuring Device Fees. Notwithstanding the provision for the requirement of an annual license for weighing and measuring devices, whenever a special request is made for the inspection or testing of a noncategorized weighing or measuring device or a consultation, the actual expenses of same may be charged to the person or firm receiving the service. Such payment or charge shall be based on the current hourly rate, plus fringe benefits, of the person providing the service.

21.07 GENERAL TESTING

When not otherwise provided by law, the Health Department Administrator, or his or her agent, shall have the power to inspect and test, to ascertain if they are correct, all weights and measures kept, offered, or exposed for sale. It shall be the duty of the Health Department Administrator, or his or her agent, to inspect and test, to ascertain if they are correct, all weights and measures commercially used **(1)** in determining the weight measurement, or count of commodities or things sold, or offered or exposed for sale, on the basis of weight, measure, or of count, or **(2)** in computing the basic charge or payment for services rendered on the basis of weight, measure or of count; provided, that with respect to single service devices, that is, devices designed to be used commercially only once and to be then discarded; and, with respect to devices uniformly mass produced, as by means of a mold or die, and not susceptible of individual adjustment tests may be made on representative samples of such devices; and the lots of which samples are representative shall be held to be correct or incorrect upon the basis of the results of the inspections and tests on such samples.

21.08 INVESTIGATIONS

The Health Department Administrator, or his or her agent, shall investigate complaints made to him/her concerning violations of the provisions of this Chapter, and shall, upon his/her own initiative, conduct such investigations as he deems appropriate and advisable to develop information on prevailing procedures in commercial quantity determination and on possible violations of the provisions of this Chapter and to promote the general objective of accuracy in the determination and representation of quantity in commercial transactions.

21.09 INSPECTIONS OF PACKAGES

The Health Department Administrator, or his or her agent, shall, from time to time, weigh or measure and inspect packages or amounts of commodities kept, offered, or exposed for sale, sold, or in the process of delivery, to determine whether the same contain the amounts represented and whether they be kept, offered, or exposed for sale, or sold, in accordance with law; and when such packages or amounts of commodities are found not to contain the amounts represented, or are found to be kept, offered, or exposed for sale in violation of law, the Health Department Administrator, or his or her agent, may order them off sale and may so mark or tag them as to show them to be illegal. In carrying out the provisions of this Section, the Health Department Administrator, or his or her agent, may employ recognized sampling procedures under which the compliance of a given lot of packages will be determined on the basis of the result obtained on a sample selected from and representative of such lot. No person shall **(1)** sell, or keep, offer, or expose for sale in intrastate commerce any package or amount of commodity that has been ordered off sale or marked or tagged as provided in this Section unless and until such package or amount of commodity has been brought into full compliance with all legal requirements, or **(2)** dispose of any package or amount of commodity that has been ordered off sale or marked or tagged as provided in this Section and that has not been brought into compliance with legal requirements, in any manner except with the specific approval of the Health Department Administrator, or his or her agent.

21.10 ENFORCEMENT AUTHORITY

A. There is hereby conferred upon sealers and inspectors of weights and measures, police power; such sealers and inspectors shall be provided with suitable badges or insignia of authority and in the

exercise of their functions shall exhibit the same, upon demand, to any person questioning their powers, and they are hereby empowered and authorized to make arrests, with or without formal warrant, of any persons violating any statute relating to weights and measures.

B. Sealers or inspectors may enter and go into or upon any structure or premises, and may stop any person or vehicle for the purpose of enforcing this Chapter. They shall inspect and test any weights and measures or commodities which are sold or used commercially as often as necessary to secure compliance with this Chapter, and may seize any evidence, or reject and mark or tag as "rejected" those which are incorrect. A representative sample may be used as the basis to determine whether any lost is incorrect.

C. Weights and measures and commodities that have been rejected may be confiscated and destroyed by a sealer or inspector if not corrected within thirty (30) days or such longer period as he or she may authorize, or if used or disposed of without his or her written authorization.

D. Sealers or inspectors may seal or mark with appropriate devices such weights and measures as are found upon inspection and test to be in conformance with this Chapter.

21.11 VENDING MACHINES

A. Notice Posting of Machines Not Operating Properly. Whenever upon inspection of any vending machines it shall be found that such vending machine is not operating properly, the Health Department Administrator or his or her agent, shall cause the vending machine to be placed in a nonvending condition by covering the coin insert slot or other mechanism with the notice prescribed and furnished by the Health Department Administrator, or his or her agent.

B. Responsibility. All vending machines in commercial use shall have conspicuously displayed thereon, or immediately adjacent thereto, adequate information detailing the method for the return of monies paid when the product or service cannot be obtained.

C. Maintenance. All vending machines in commercial service and all mechanisms and devices attached thereto or used in connection therewith shall continuously be maintained in proper operating condition throughout the period of such service.

21.12 METHOD OF SALE OF COMMODITIES

A. Commodities in liquid form shall be sold by liquid measure and commodities not in liquid form shall be sold by weight, but liquid commodities may be sold by weight and commodities not in liquid form may be sold by count or measure if such methods are in general use and given accurate information as to the quantity of commodity sold.

B.1. Berries and small fruits may be sold by measure only if in containers having capacities of one-half dry pint, one dry pint or one dry quart.

2. If a commodity is packaged in an aerosol container, it shall be sold by weight (including the propellant).

3. This Section shall not apply to commodities sold in compliance with a State or Federal law which prescribes another method of sale, or to commodities sold for immediate consumption on the premises where sold.

21.13 DECLARATION OF QUANTITY

A. No commodity which is marked, tagged or labeled, or for which a sign is displayed, with a selling price, shall be sold unless the weight, measure or count of the commodity is conspicuously declared on the commodity or its tag, label or sign, but a declaration of count is not required if the selling price is for a single unit, or a set or combination of commodities customarily sold to and understood by consumers as a single unit.

B. No commodity shall be wrapped or its container made, formed or filled so as to mislead the purchaser; nor shall the qualifying term "when packed", or the terms "jumbo", "giant" or "full", or words of similar import that tend to mislead the purchaser as to the amount of the commodity, be used in connection with a declaration of quantity.

C. Variations from Declared Quantity. The magnitude of permitted variations from declared quantity shall be determined by rules set forth by the Wisconsin Department of Agriculture, Trade and Consumer Protection and the facts in the individual case.

21.14 DECLARATIONS OF UNIT PRICE ON RANDOM WEIGHT PACKAGES

In addition to the declarations required by **§21.13** of this Chapter, any commodity in package form, the package being one of a lot containing random weights of the same commodity and bearing to total selling price of package, shall bear on the outside of the package a plain and conspicuous declaration of the price per single unit of weight.

21.15 MISLEADING PACKAGES

No commodity in package form shall be so wrapped nor shall it be in a container so made, formed or filled, as to mislead the purchaser as to the quantity of the contents of the package, and the contents of a container shall not fall below such reasonable standard of fill as may have been prescribed for the commodity in question by the Health Department Administrator, or his or her agent.

21.16 ADVERTISING COMMODITIES FOR SALE

Whenever a commodity in package form is advertised in any manner and the retail price of the package is stated in the advertisement, there shall be closely and conspicuously associated with such statement of price a declaration of the basic quantity of contents of the package as is required by law or regulation to appear on the package.

21.17 BREAD

Each loaf of bread and each unit of a twin or multiple loaf of bread, made or produced for sale, kept, offered, exposed for sale, or sold, whether or not the bread is wrapped or sliced shall be one of the following weights and no others: one-half pound, one pound, one and one-half pounds, or multiples of one pound avoirdupois weight, within variations or tolerances prescribed in this Chapter. Provided, that the provisions of this Section shall not apply to biscuits, buns or rolls, weighing 4 ounces or less, or to "stale bread" sold and expressly represented at the time of sale as such, and that the marking provisions of **§21.13** shall not apply to unwrapped loaves of bread.

21.18 BULK DELIVERIES SOLD IN TERMS OF WEIGHT AND DELIVERED BY VEHICLE

When a commodity in bulk is delivered by vehicle to an individual purchaser and the commodity is

sold in terms of weight units, the delivery shall be accompanied by a duplicate delivery ticket with the following information clearly stated in ink or by means of other indelible marking equipment: **(1)** the name and address of the vendor; **(2)** the name and address of the purchaser; and, **(3)** the net weight of the delivery expressed in pounds, but where milk is picked up at farms, only the identity of the vendor and the net weight need be stated. If the net weight is derived from determination of gross and tare weights, such gross and tare weights also shall be stated in terms of pounds on the ticket. One of these tickets shall be retained by the vendor, and the other shall be delivered to the purchaser at the time of delivery of the commodity, or shall be surrendered, on demand to the inspector or sealer, who, if he/she desires to retain it as evidence, shall issue a weight slip in lieu thereof for delivery to the purchaser. If the purchaser himself carries away his/her purchase, the vendor shall be required only to give to the purchaser at the time of sale a delivery ticket stating the number of pounds of commodity delivered to him or her. If the commodity is to be weighed by the purchaser, the purchaser shall furnish the vendor the duplicate delivery ticket provided for herein.

21.19 HEATING OIL AND MOTOR FUEL

Heating Oil. All heating oil shall be sold by liquid measure or by net weight. In the case of each delivery of liquid fuel not in package form, and in an amount greater than 10 gallons in the case of sale by liquid measure or 100 pounds in the case of sale by weight, there shall be rendered to the purchaser, either **(1)** at the time of delivery, or **(2)** or otherwise between the vendor and the purchaser, a delivery ticket or a written statement on which, in ink, or other indelible substance, there shall be clearly and legibly stated **(a)** the name and address of the vendor, **(b)** the name and address of the purchaser, **(c)** the identity of the type of fuel comprising the delivery, **(d)** the unit price (that is, the price per gallon or per pound, as the case may be), of the fuel delivered, **(e)** in the case of sale by liquid measure, the liquid volume of the delivery, together with the printmeter readings from which such liquid volume has been computed, expressed in terms of the gallon and its binary or decimal subdivisions, and **(f)** in the case of sale by weight, the net weight of the delivery, together with any weighing scale readings from which such net weight has been computed, expressed in terms of tons or pounds avoirdupois.

21.20 PROHIBITED ACTS

- A.** Hinders, obstructs or impersonates a sealer or inspector.
- B.** Uses or has in possession for use in buying or selling any commodity or service, or sells, any incorrect weight or measure or causes a weight or measure to be incorrect.
- C.** Represents in any manner a false quantity in connection with the purchase or sale, or any advertising thereof, of any commodity, thing or service.
- D.** Uses or disposes of any rejected weight or measure, or commodity, or removes therefrom any official tag, seal, stamp or mark, without written authority from a sealer or inspector.

21.21 PRESUMPTIVE EVIDENCE

For the purposes of this Chapter, proof of the existence of a weight or measure or a weighing or measure device in or about any building, enclosure, stand, or vehicle in which or from which it is shown that buying or selling is commonly carried on, shall, in the absence of conclusive evidence to the contrary, be presumptive proof of the regular use of such weight or measure or weighing or measuring device for commercial purposes and of such use by the person in charge of such building enclosure, stand or vehicle.

21.22 PENALTY

Any person, firm, corporation or organization found guilty of a violation of any section of this Chapter for which a specific penalty is not herein provided shall, upon conviction thereof, be fined the sum of not less than Twenty-five (\$25.00) Dollars nor more than Two Hundred (\$200.00) Dollars, together with the costs of the prosecution, and in default of payment thereof, shall be imprisoned until such forfeiture and cost are paid, but not to exceed thirty (30) days.

Each and every twenty-four (24) hours such violation shall continue, except as otherwise provided in this Chapter, shall constitute a separate offense.

21.23 SEPARABILITY PROVISION

If any provision of this Chapter is declared unconstitutional, or the applicability thereof to any person or circumstance is held invalid, the constitutionality of the remainder of this Chapter and the applicability thereof to other persons and circumstances shall not be affected thereby.

21.24 REPEAL OF CONFLICTING LAWS

All City Chapters and parts of Chapters contrary to or inconsistent with the provisions of this Chapter, and specifically §13.12 of the Code of General Ordinances, Kenosha, Wisconsin, are repealed insofar as they might operate in the future; but as to offenses committed liability incurred, and claims now existing thereunder, the existing law shall remain in full force and effect.

21.25 CITATION

This Chapter may be cited as the Consumer Protection and Weights and Measures Chapter of the Code of General Ordinances, Kenosha, Wisconsin.

CHAPTER XXII
FAIR HOUSING

22.01 DECLARATION OF POLICY

It is hereby declared to be the policy of the City of Kenosha pursuant to the Constitution of the United States and the State of Wisconsin, and also its power to protect the public health, safety and general welfare, that all persons regardless of sex, race, color, physical condition, disability, sexual orientation, religion, national origin, marital status of the person maintaining a household, family status, lawful source of income, age or ancestry, are entitled to fair and equal access to housing; and to that end, the City of Kenosha hereby enacts the following Ordinance which prohibits any person from discriminating against any other person by impairing access to any housing on the basis of sex, race, color, physical condition, disability, sexual orientation, religion, national origin, marital status of the person maintaining a household, family status, lawful source of income, age or ancestry.

22.02 DEFINITIONS

In this Section, unless the context requires otherwise:

A. "City Attorney" means the City Attorney of the City of Kenosha, and any Assistant City Attorney of the City of Kenosha acting on his or her behalf.

B. "Commission" means the Kenosha Commission of Human Relations.

C. "Disability" means a physical or mental impairment that substantially limits one or more major life activities, a record of having such an impairment or being regarded as having such an impairment. "Disability" does not include the current illegal use of a controlled substance, as defined in §161.01(4), Wisconsin Statutes, unless the individual is participating in a supervised drug rehabilitation program.

D. "Discriminate" and "discrimination" means to segregate, separate, exclude, or treat any person or class of persons unequally because of sex, race, color, physical condition, disability, sexual orientation, religion, national origin, marital status of the person maintaining a household, lawful source of income, family status, age or ancestry; and, for a person engaged in the business of accepting mortgages on real estate or insuring against hazards, because of the atmospheric, economic, ethnic, racial or social characteristics of the neighborhood in which housing is located. It is intended that the factors set forth herein shall be the sole basis for prohibiting discrimination.

E. "Family Status" means any of the following conditions that apply to a person seeking to rent or purchase housing or to a member or prospective member of the person's household regardless of the person's marital status:

1. A person is pregnant.
2. A person is in the process of securing sole or joint legal custody, periods of physical placement or visitation rights of a minor child.
3. A person's household includes one or more minor or adult relatives.
4. A person's household includes one or more adults or minor children in his or her legal custody or physical placement or with whom he or she has visitation rights.
5. A person's household includes one or more adults or minor children placed in his or her care under a court order, under a guardianship or with the written permission of a parent or other person having legal custody of the adult or minor child.

F. "Housing" means any improved property, including any mobile home park, which is used or

occupied, or is arranged, intended or designed to be used or occupied, as a home or residence.

G. "Person" means any individual, partnership, labor or other association, corporation, legal representative, receiver, trustee manager, employee or any other agent of any such person.

H. "Private Nonprofit Corporation" means a corporation chartered under Chapter 181, Wisconsin Statutes, and recognized as tax exempt under Section 501(c)(3) of the Internal Revenue Act of 1954, as amended.

I. "Sexual Orientation" means having a preference for heterosexuality, homosexuality or bisexuality, having a history of such a preference or being identified with such a preference.

J. "Unimproved Residential Lot" means any residential lot upon which no permanent building or structure containing living quarters has been constructed.

22.03 PROHIBITED ACTS

A. It is a prohibited act for any person to discriminate:

1. By refusing to sell, lease, finance or construct housing or by refusing to discuss the terms thereof.
2. By refusing to permit inspection or exacting different or more stringent price, terms or conditions for the sale, lease, financing or rental of housing.
3. By refusing to finance or sell an unimproved residential lot or to construct a home or residence upon such a lot.
4. By publishing, circulating, issuing or displaying, or causing to be published, circulated, issued or displayed, any communication, notice, advertisement or sign in connection with the sale, financing, lease or rental of housing, which states or indicates any discrimination in housing.
5. For a person in the business of insuring against hazards, by refusing to enter into, or by exacting different terms, conditions or privileges with respect to a contract of insurance against hazards to a dwelling.
6. By refusing to renew a lease, causing the eviction of a tenant from rental housing or engaging in the harassment of a tenant.

B. It is a prohibited act for any person to induce or attempt to induce any other person to sell, rent or lease any dwelling by representatives regarding the present or prospective entry into the neighborhood of a person or persons of a particular race, color, religion, national origin or economic status or by representatives to the effect that such present or prospective entry will or may result in:

1. The lowering of real estate values in the area concerned;
2. A deterioration in the character of the area concerned;
3. An increase in criminal or antisocial behavior in the area concerned; or,
4. A decline in the quality of the schools or other public facilities serving the area.

C. No person may coerce, intimidate, threaten or interfere with any person in the exercise or enjoyment of any right granted or protected by this Section, or with any person who has aided or encouraged another person in the exercise or enjoyment of any right granted or protected by this Section.

22.04 ACTS NOT PROHIBITED

A. Nothing in this Chapter shall prohibit discrimination on the basis of age in relation to housing designed to meet the needs of elderly individuals.

CODE OF GENERAL ORDINANCES, 2020 - KENOSHA, WISCONSIN

B. Nothing in this Chapter shall prohibit a person from exacting different or more stringent terms or conditions for financing housing based on the age of the individual applicant for financing if the terms or conditions are reasonably related to the individual applicant.

C. Nothing in the Chapter shall prohibit the development of housing designed specifically for persons with a handicap and discrimination on the basis of handicap in relation to such housing.

D. Nothing in this Section shall be deemed to prohibit an owner, or his or her agent, from requiring that any person who seeks to buy, rent or lease housing supply information concerning his or her family, marital, financial and business status, but not concerning race, color or creed. It shall not be discrimination based on family status to act as otherwise prohibited in Section 22.03 A.1., 4., or 6. if the number of individuals under eighteen (18) years of age equals or exceeds the number of bedrooms in the unit.

22.05 ADMINISTRATION AND ENFORCEMENT

Any person who claims to have been injured by a discriminatory housing practice or who believes that he/she will be irrevocably injured by a discriminatory housing practice that is about to occur (hereinafter "person aggrieved"), may file a complaint with the Department of City Development (hereinafter "Department"). Upon receipt of such a complaint, the Department shall conduct an investigation of the complaint. The Department may request assistance in its investigation of any private nonprofit corporation maintaining an office within Southeastern Wisconsin which has staff trained to supervise such an investigation.

If the Department finds reason to believe that a discriminatory practice has occurred or is about to occur, it shall attempt through conciliation or persuasion, to obtain compliance with this Chapter. If all such attempts at conciliation or persuasion fail, the Department shall notify the City Attorney of its findings. If probable cause is found, the City Attorney shall then issue a complaint if, in his/her judgment, an action of discrimination is sustainable in court.

The City Attorney shall file with the Human Relations Commission a semi-annual report of all complaints and dispositions processed by the City Attorney's Office.

22.06 PENALTIES

(See §432 (2) in Statutes and Chapter 188, Laws of 1979)

A. Any person who willfully violates this Section shall, for the first such violation, forfeit not less than \$100.00, nor more than \$1000.00. In default of such payment, the violator shall be imprisoned in the County Jail for not less than five (5) days, nor more than thirty (30) days.

B. Any person adjudged to have violated this Section within five (5) years after having been adjudged to have violated this Section, for every violation committed within the five (5) years, shall forfeit not less than \$1000.00, nor more than \$10,000.00. In default of such payment, the violator shall be imprisoned in the County Jail for not less than thirty (30) days, nor more than one (1) year.

C. Payment of any forfeiture under this Ordinance shall be stayed during pendency of any appeal.

22.07 SEVERABILITY

The provisions of this Ordinance are severable. If any provision of this Ordinance is invalid, or if the application to any person or circumstance is invalid, such invalidity shall not affect the other provisions of

this Ordinance which can be given effect without the invalid provisions and/or application.

22.08 TITLE

This Ordinance shall be known as the **Kenosha Fair Housing Ordinance**.

CHAPTER XXIII
NOISE CONTROL

23.1 FINDINGS AND DECLARATION OF POLICY

A. It is found that:

1. The making, creating and permitting of unnecessary, excessive, unnatural, annoying, prolonged or unusually loud noises within the limits of the City of Kenosha is a condition which has existed for some time and the extent and volume of such noises is increasing; and,

2. Noises or noise levels which, under some circumstance, would be normal and acceptable, may become unnecessary, excessive, unnatural, annoying, prolonged or unusually loud by virtue of their time and place and,

3. Noises which are unnecessary, excessive, unnatural, annoying, prolonged or unusually loud in relationship to their time and place are a public nuisance and are detrimental to the public health, safety, welfare, comfort, repose, peace and prosperity.

B. It is declared:

1. That the policy of the City of Kenosha, Wisconsin, is to prohibit noises which are unnecessary, excessive, unnatural annoying, prolonged or unusually loud in relationship to their time and place.

2. That noises at certain levels and frequencies as herein described, are detrimental to the public health, safety, welfare, comfort, convenience and prosperity, and that such noises must be systematically prescribed.

3. This Ordinance is not intended to supersede the City's Disorderly Conduct Ordinances. Prosecutions may be made under our Disorderly Conduct Ordinances where circumstances do not make it practical to measure the noise in question with a noise measuring device.

23.2 DEFINITIONS

All terminology used in this Ordinance, not defined below, shall be in conformance with applicable publications of the American National Standards Institute (ANSI) or its successor body.

A. "Ambient Noise" is the all-encompassing noise associated with a given environment, usually being a composite of sounds with many sources near and far, but excluding the noise source being measured.

B. "A-Weighted Sound Level" means the sound pressure level in decibels as measured on a sound level meter using A-weighting network. The level so read is designated dB(A) or dBA.

C. "Commercial Area" has the same definition as that term is defined in the Zoning Ordinance, City of Kenosha, Wisconsin.

D. "Commercial Purpose" shall mean and include the use, operation, or maintenance of any sound amplifying equipment for the purpose of advertising any business, or any goods, or any services, or for the purpose of attracting the attention of the public to, or advertising for, or soliciting patronage or customers to or for any performance, show, entertainment, exhibition, or event, or for the purpose of demonstrating any such sound equipment.

E. "Construction" means any site preparation, assembly, erection, substantial repair, alteration, or similar action, but excluding demolition, for or of public or private right-of-ways, structures, utilities or similar property.

F. "Cycle" is the complete sequence of values of a periodic quantity which occurs during a period.

G. "Daytime" means the hours from 7:00 A.M. to 10:00 P.M.

H. "Decibel (dB)" means a unit for measuring the volume of a sound, equal to 20 times the logarithm to the base 10 of the ratio of the pressure of the sound measured to the reference pressure, which is 20 micropascals (20 micronewtons per square meter).

CODE OF GENERAL ORDINANCES, 2020 - KENOSHA, WISCONSIN

I. "**Demolition**" means any dismantling, intentional destruction or removal of structures, utilities, public or private right-of-way surfaces, or similar property.

J. "**Emergency**" means any occurrence or set of circumstances involving actual or imminent physical trauma or property damage which demands immediate action.

K. "**Emergency Work**" means any work performed for the purpose of preventing or alleviating the physical trauma or property damage threatened or caused by an emergency.

L. "**Environmental Protection Office(r)/Noise Control Office(r) (EPO/NCO)**" means any designee(s) of the Administrator of Health.

M. "**Frequency**" of a function periodic in time is the reciprocal of the primitive period. The unit is the cycle per unit time and shall be specified as cycles per second unless another unit of time is more convenient in a particular case.

N. "**Impulsive Sound**" means sound of short duration, usually less than one second, with an abrupt onset and rapid decay. Examples of sources of impulsive sound include explosions, drop forge impacts, and the discharge of firearms.

O. "**Industrial Area**" has the same definition as that term is defined in the Zoning Ordinance, City of Kenosha, Wisconsin.

P. "**Microbar**" is a unit of pressure commonly used in acoustics and is equal to one dyne per square centimeter.

Q. "**Motor Vehicle**" has the same definition as that term is defined by Chapter 340 of the Wisconsin Statutes.

R. "**Muffler or Sound Dissipative Device**" means a device for abating the sound of escaping gases of an internal combustion engine.

S. "**Nighttime**" means the hours of 10:00 P.M. until 7:00 AM. of the following day.

T. "**Noise**" shall mean any sound which is unnecessary, excessive, unnatural, annoying, prolonged or unusually loud in relationship to its time, place and use effect.

U. "**Noise Disturbance**" means any sound which (a) endangers or injures the safety or health of humans or animals, or (b) annoys or disturbs a reasonable person of normal sensitivities, or (c) endangers or injures person or real property.

V. "**Noncommercial Purpose**" shall mean the use, operation, or maintenance of any sound amplifying equipment for other than a "Commercial Purpose". "Noncommercial Purpose" shall mean and include, but shall not be limited to, philanthropic, political, patriotic, and charitable purpose.

W. "**Period**" of a periodic quantity is the smallest increment of time for which the function repeats itself.

X. "**Periodic Quantity**" is oscillating quantity, the values of which recur for equal increments of time.

Y. "**Person**" means any individual, association, partnership, or corporation, and includes any officer, employee, department, agency or instrumentality of a State or any political subdivision of a State.

Z. "**Powered Model Vehicle**" means any self-propelled airborne, waterborne, or landborne plane, vessel or vehicle, which is not designed to carry persons, including, but not limited to, any model airplane, boat, car, or rocket.

AA. "**Public Right-of-Way**" means any street, avenue, boulevard, highway, sidewalk or alley or similar place which is owned or controlled by a governmental entity.

BB. "**Public Space**" means any real property or structures thereon which are owned or controlled by a governmental entity.

CC. "**Pure Tone**" means any sound which can be distinctly heard as a single pitch or a set of single pitches. For the purposes of this Ordinance, a pure tone shall exist if the one-third octave band sound pressure level in the band with the tone exceeds the arithmetic average of the sound pressure levels of the two contiguous one-third octave bands by 5 dB for center frequencies of 500 Hz and above and by 8 dB for center frequencies between 160 and 400 Hz and by 15 dB for center frequencies less than or equal to 125 Hz.

DD. "**Real Property Boundary**" means an imaginary line along the ground surface, and its vertical extension, which separate the real property owned by one person from that owned by another person, but

not including intra-building real property divisions.

EE. "Residential Area" has the same definition as that term is defined in the Zoning Ordinance, City of Kenosha, Wisconsin.

FF. "Sound" means an oscillation in pressure, particle displacement, particle velocity or other physical parameter, in a medium with internal forces that causes compression and rarefaction of that medium. The description of sound may include any characteristic of such sound, including duration, intensity and frequency.

GG. "Sound Amplifying Equipment" is any machine or device for the amplification of the human voice, music, or any other sound, but shall not include standard automobile radios when used and heard only by the occupants of the vehicle in which the automobile radio is installed, and as used in this Chapter shall not include warning devices on authorized emergency vehicles used only for traffic safety, law enforcement, or authorized emergency purposes.

HH. "Sound Level" means the weighted sound pressure level obtained by the use of a sound level meter and frequency weighting network, such as A, B, or C as specified in American National Standards Institute specifications for sound level meters (ANSI S1.4-1971, or the latest approved revision thereof). If the frequency weighting employed is not indicated, the A-weighting shall apply.

II. "Sound Level Meter" means an instrument which includes a microphone, amplifier, RMS detector, integrator or time averager, output meter, and weighting networks used to measure sound pressure levels.

JJ. "Sound Pressure" means the instantaneous difference between the actual pressure and the average or barometric pressure at a given point in space, as produced by sound.

KK. "Sound Pressure Level" means 20 times the logarithm to the base 10 of the ratio of the RMS sound pressure to the reference pressure of 20 micropascals (20×10^{-6} N/m²). The sound pressure level is denoted L_p or SPL and is expressed in decibels.

LL. "Sound Truck" is any vehicle regardless of motive power, whether in motion or stationary, having mounted thereon, or attached thereto, any sound amplifying equipment.

MM "Weekday" means any day Monday through Friday which is not a legal holiday.

NN. "Zoning District" is any district established by the Kenosha Zoning Ordinance of the Municipal Code of the City of Kenosha.

23.3 ENFORCEMENT

This Ordinance shall be enforced by the Police and Health Departments, except that the Health Department is not responsible for enforcing provisions of this Ordinance relative to traffic noises. The Health Department shall be primarily responsible for enforcement during regular City Hall working hours and the Police Department shall be primarily responsible for enforcement of this Ordinance during all other hours.

23.4 EXCESSIVE NOISE DECLARED A NUISANCE

"Noise" as defined in this Chapter is hereby declared to be a public nuisance and may be subject to abatement procedures as described herein. Such abatement may be in addition to administrative proceedings, fines and penalties as provided in this Ordinance. It shall be the duty of the Health Officer upon receiving a "noise" complaint, to determine if a public nuisance exists as defined in this Chapter and to take such action as he deems necessary to insure compliance with this Chapter. Conditions of "noise" which are specifically exempted or for which a Variance Permit has been issued in conformity with provisions of this Chapter shall be exempt from the application of the provisions of this Chapter.

23.5 NOISE PROHIBITED

A. Noise Disturbances Prohibited. No person shall unreasonably make, continue, or cause to be made or continued, any noise or noise disturbance. Noncommercial public speaking and public assembly

CODE OF GENERAL ORDINANCES, 2020 - KENOSHA, WISCONSIN

activities conducted on any public space or public right-of-way shall be exempt from the operation of this Section.

B. Specific Prohibitions. The following acts, and the causing thereof, are declared to be in violation of this Ordinance:

1. Radio, Television Sets, Musical Instruments and Similar Devices. Operating, playing or permitting the operation or playing of any radio, television, phonograph, drum, musical instruments, sound amplifier, or similar device which produces, reproduces or amplifies sound:

a. Between the hours of 10:00 P.M. and 7:00 A.M. the following day in such a manner as to create a noise disturbance across a real property boundary; except for activities open to the public and for which a permit has been issued by the Department of Public Works for the City of Kenosha, Wisconsin, according to criteria set forth in §23.6;

b. In such a manner as to create a noise disturbance in any room in any dwelling unit located in any adjacent premises;

c. In such a manner as to create a noise disturbance at 50 feet from such device, when operated in or on a motor vehicle on a public right-of-way or public space, or in a boat on public waters;

d. In such a manner as to create a noise disturbance to any person other than the operator of the device, when operated by any passenger on a common carrier;

e. This Section shall not apply to noncommercial spoken language covered under §23.5 B.2..

2. Loudspeakers/Public Address Systems.

a. Using or operating for any noncommercial purpose any loudspeaker, public address system, or similar device between the hours of 10:00 P.M. and 8:00 A.M. the following day, such that the sound therefrom creates a noise disturbance across a residential real property boundary.

b. Using or operating for any commercial purpose any loudspeaker, public address system, or similar device (1) such that the sound therefrom creates a noise disturbance across a real property boundary; or (2) between the hours of 5:00 P.M. and 8:00 A.M. the following day on a public right-of-way or public space.

3. Powered Model Vehicles. Operating or permitting the operation of powered model vehicles so as to create a noise disturbance across a residential real property boundary, in a public space or within a noise sensitive zone between the hours of 9:00 P.M. and 7:00 A.M. the following day. Maximum sound levels in a public space during the permitted period of operation shall conform to those set forth for residential land use in **Table 1** of Section 23.6 and shall be measured at a distance of 100 feet from any point on the path of the vehicle. Maximum sound levels for residential property, during the permitted period of operation, shall be governed by Section 23.6.

4. Emergency Signaling Devices.

a. The intentional sounding or permitting the sounding outdoors of any fire, burglar, or civil defense alarm siren, whistle or similar stationary emergency signaling device, except for emergency purposes or for testing, as provided in Subsection b.

b. (1) Testing of a stationary emergency signaling device shall occur at the same time of day each time such a test is performed, but not before 9:00 A.M. or after 5:00 P.M. Any such testing shall use only the minimum cycle test time. In no case shall such test time exceed 60 seconds.

(2) Testing of the complete emergency signaling system, including the functioning of the signaling device and the personnel response to the signaling device, shall not occur more than once in each calendar month. Such testing shall not occur before 9:00 A.M. or after 5:00 P.M. The time limit specified in Subsection **(1)** shall not apply to such complete system testing.

c. Sounding or permitting the sounding of any exterior burglar [or fire] alarm or any motor vehicle burglar alarm unless such alarm is automatically terminated within fifteen minutes of activation.

23.6 CRITERIA TO DETERMINE "NOISE"

A. Maximum Permissible Sound Levels By Land Use. No person shall operate or cause to be operated on private property any source of sound in such a manner as to create a sound level which

CODE OF GENERAL ORDINANCES, 2020 - KENOSHA, WISCONSIN

exceeds the limits sets forth in **Table 1.** when measured at or within the property boundary of the receiving land use.

TABLE 1. SOUND LEVELS

Transmitting Land Use Zoning	Time	Sound Level Limit, dBA
A-1, A-2, C-1, IP, FW, RR-1, RR-2, Rs-4, Rs-2, Rs-3, Rd, Rg-1, Rg-2, Rm-1, Rm-2, & All Other Zoning Not Specifically Listed In This Table. (Residential, Public Space, Open Space, Agricultural or Institutional)	7:00 A.M.- 10:00 P.M.	60
	10:00 PM. -7:00 A.M.	50
B-1, B-2, B-3, B-4	At All Times	70
M-1, M-2	At All Times	75

B. Correction For Character of Sound. For any source of sound which emits a pure tone or impulsive sound, the maximum sound level limits set forth in §23.6 A. shall be reduced by five (5) dBA.

C. Exemptions. The provisions of this Section shall not apply to refuse collection vehicles, aircraft and airport operations, interstate railway locomotives and cars, and emergency signaling devices, the latter of which are regulated in §23.5 B.4., of the Code of General Ordinances.

23.7 METHOD OF MEASURING NOISE

A. Equipment. Noise measurement shall be made with a sound level meter manufactured according to the specifications of the American National Standards Institute, USA Standard Specifications for General Purposes Sound Level Meters (S1.4-1971) and Preferred Center Frequencies for Acoustical Measurements (S1.6-1960) or any subsequent nationally adopted standards superseding the above standards.

B. Location and Interpretation. Noise measurement shall be made at the nearest lot line of premises from which noise complaint(s) are received and shall be made at a height of at least three feet above the ground and at least three feet away from walls, barriers, obstructions or sound reflective surfaces. Where the nature of the noise permits, the slow response setting shall be used to obtain the noise level on the sound level meter.

23.8 VARIANCE PERMITS

Variance Permits may be issued by the Health Officer to exceed the noise standards set forth in this Ordinance as follows:

A. Temporary Variance Permits.

1. General. A Temporary Variance Permit may be issued upon request provided that the work producing such noise is necessary to promote the public health and/or welfare and reasonable steps are taken to keep such noise at the lowest possible practical level.

2. Special Community Events. A Temporary Variance Permit may be issued for special events, such as circuses, 4th of July celebrations and similar community events, which are limited in duration and are generally acceptable to the people of the community; provided that precautions are taken to maintain the noises produced at the lowest practical level.

3. Procedure to Obtain a Variance Permit. Applications for Temporary Variance Permits must be made in writing to the Health Officer and shall contain all of the following pertinent information:

- a. Dates requested;
- b. Time and place of operation;
- c. Equipment and operation involved;
- d. Necessity for such permit;
- e. Steps to be taken to minimize noise; and,
- f. Name of responsible person(s) who will be present at the operation site while the noise is produced.

B. Variance Permits of Indefinite Duration.

1. It is recognized that it is not technically or economically feasible for certain business operations and equipment to comply with the standards set forth herein as of the date of this Ordinance. The Health Officer shall therefore issue a Variance Permit on existing business operations and equipment which produces excessive noise if it is found that it is not technically or economically feasible to alter such operation to reduce noise to within the prescribed standards set forth in this Ordinance. Applications for such variances must be made to the Health Officer by an affected party in a letter setting forth the reasons that such variance should be granted. The Health Officer, after review of all circumstances and the degree of nuisance, shall reply in writing giving the variance, denying the variance, or setting forth conditions or limitations under which the variance will be granted.

2. In the event the Health Officer issues an order citing a violation of this Ordinance on an existing business operation and equipment and the party cited applies for a variance within ten (10) days of such citation, then all penalties provided shall be tolled from the date the application is filed until a final order or decision has been issued on the merits of the application.

23.9 EXEMPTIONS

A. Construction Sites, Public Utilities, Public Works. The daytime criteria as set forth in §23.6 shall not apply to construction sites, public utilities and public works projects and operations during the daytime hours from Monday through Saturday, inclusive; provided, however, that noise production shall be minimized through proper equipment operation and maintenance. Stationary equipment on construction projects lasting more than ten (10) days within residential districts shall be shielded or located so as not to cause unnecessary noise.

B. Emergency Operations. Emergency short-term operations which are necessary to protect the health and welfare of the citizens; such as, emergency utility and street repair, fallen tree removal or emergency fuel oil delivery, shall be exempt from the criteria as set forth in §23.6, provided that reasonable steps shall be taken by those in charge of such operations to minimize noise emanating from the same.

C. Noises Required by Law. The provisions of §23.6 shall not apply to any noise required specifically by law for the protection of safety of people or property.

D. Lawn Mowers, Garden Tools, Etc. Power equipment such as lawn mowers, small lawn and garden tools, riding tractors and snow removal equipment which is necessary for the maintenance of property, is kept in good repair and maintenance and which equipment, when new, would not comply with the standards set forth in this Ordinance, shall be exempted from the provisions of §23.6. No person shall operate such equipment, with the exception of snow removal equipment, during the hours of 9:00 P.M. through 8:00 A.M., inclusive.

E. Residential Air Conditioners. Noise emitted by residential air conditioners shall be judged by the criteria set forth in §23.6.

F. Highway Vehicles. Vehicles operating on City streets, alleys and highways shall be subject to noise control as set forth in §23.15 of this Ordinance.

G. Airplanes. Aircraft operations which are controlled specifically by federal law and enforcement shall be exempted from the provisions of this Chapter.

H. Bells, Chimes. Bells, chimes and similar devices which signal the time of day and operate during the daytime hours for a duration of no longer than five (5) minutes in any given one hour period shall be exempt from the daytime noise limitations of §23.6.

23.10 CONTROL OF NIGHTTIME NOISES EMITTED BY RESIDENTIAL AIR CONDITIONERS

A. Excessive Noise Prohibited. No person shall install, operate or use any residential air conditioners which create a noise level in a sleeping room in any dwelling unit located on any adjacent premises in excess of five decibels above the ambient noise level at the location being measured.

B. Measurement. Upon receiving a complaint, the Health or Police Department shall conduct a noise survey through the use of a sound level meter. The sound pressure levels shall be measured in a sleeping room in the complainant's premises with the sound level measuring microphone placed three feet from an open window nearest to the source of the noise and not less than three feet above the floor of the room in which the measurement is made. If the noise level exceeds the level specified in Paragraph A. above, the noise shall be deemed excessive and in violation of this Section.

23.12 SOUND TRUCKS

A. Purpose of Regulation. The Council recognizes that the use of sound amplifying equipment when operated for free speech purposes is protected by the constitutional rights of freedom of speech and assembly, but nevertheless feels obligated to reasonably regulate the use of such equipment in order to protect the correlative constitutional rights of those who wish privacy and freedom from the nuisance of loud and unnecessary noise.

B. Sound Trucks Must Be Registered. No person shall use a sound truck on the street with its sound amplifying equipment in operation without having first filed an application with the County Health Officer in writing. This application shall be filed in triplicate at least five (5) working days prior to the date on which it is intended to use such equipment and shall state the following:

1. Name and home address of the registrant;
2. Address and place of business of registrant;
3. License number and motor number of the sound truck to be used by registrant;
4. Name, address and telephone number of person who owns the sound truck;
5. Name, address and telephone number of person having direct charge of the sound truck;
6. Names and addresses of all persons who will use or operate the sound truck;
7. The purpose for which the sound truck will be used;
8. A general statement as to the section or sections of the City in which the sound truck will be used;
9. The proposed hours of operation of the sound truck;
10. The date(s) proposed operation of the sound truck;
11. A general description of the sound truck amplifying equipment which is to be used;
12. The maximum sound producing power of the sound amplifying equipment, expressed in decibels at a reference distance of thirty feet; and,
13. Whether the sound amplifying equipment will be used for commercial or noncommercial purposes.

C. Registration Term.

1. Annual Registration. The registration shall expire on June 30st, following its issuance. The registration is a one (1) term license which is nonrenewable. A new Annual Registration application shall be filed for review for each subsequent registration term.

2. One (1) Day Registration. A single day registration may be issued for one (1) day only. The One (1) Day Registration application shall designate the date the Registration will be utilized.

D. Processing Applications.

1. The County Health Officer shall return to the applicant an approved certified copy of the applications unless he/she finds that:

a. The conditions of the motor vehicle movement are such that the use of equipment would constitute a detriment to traffic safety; or,

b. The conditions of pedestrian movement are such that use of the equipment would constitute an unreasonable interference with traffic; or,

c. The application reveals that the applicant would violate the provisions set forth in this Chapter or any other provisions of this Code.

E. Disapproval. In the event the application is disapproved, the County Health Officer shall endorse upon the statement his/her reasons for disapproval and return it forthwith to applicant.

F. Regulations. The commercial and noncommercial use of sound amplifying equipment shall be subject to the following regulations:

1. The only sounds permitted shall be either music or human speech, or both.

2. The operation of sound amplifying equipment shall only occur between the hours of 8:00 A.M. and 10:00 P.M. each day.

3. No sound emanating from sound amplifying equipment shall exceed fifteen (15) dBA above the ambient as measured at any property line.

4. Sound amplifying equipment shall not be operated within 300 feet of churches, schools and hospitals.

5. In any event, the volume of sound shall be so controlled that it will not be unreasonably loud, raucous, jarring, disturbing or a nuisance to persons of normal sensitiveness within the area of audibility.

G. Appeal. Any person aggrieved by disapproval of an application may appeal to the City Council by filing a written notification thereof with the City Clerk within ten (10) days from the date the said statement is mailed or given to applicant. The City Council shall consider said appeal at its first meeting following the filing of the appeal.

H. Fees.

1. Annual Registration. The Annual Registration Fee shall be Two Hundred Dollars (\$200.00) per applicant. Prior to the approval of the application, the application fee shall be paid to the City if the loudspeaker or sound amplifying equipment is to be used for commercial purposes.

2. One (1) Day Registration. The One (1) Day registration shall be Ten Dollars (\$10.00) per day.

3. No fee shall be required for the operation of a loudspeaker or sound amplifying equipment for noncommercial purposes.

23.13 CONTROL OF TRAFFIC NOISES

A. Rules and Regulations. The Health Officer, in consultation with the Chief of Police, shall promulgate and adopt rules and regulations which set standards for the control of noises created by motor vehicles operating on public highways; provided however, that such standards shall be in conformity with

CODE OF GENERAL ORDINANCES, 2020 - KENOSHA, WISCONSIN

federal and state standards which may be adopted and are applicable and which govern the emission of noise from such vehicles. The rules and regulations adopted by the Health Officer shall have the same effect as law. The Health Officer shall submit a copy of the rules and regulations to the Common Council for approval prior to his/her adoption of the same. He/she shall file a copy of adopted rules and regulations in the office of the City Clerk.

B. Operation of Noisy Vehicles. No person shall operate any vehicle on the alleys, streets and highways of the City of Kenosha which, as a result of the nature of the vehicle or the manner it is driven, exceeds the noise levels established in the rules and regulations adopted by the Health Officer pursuant to this Section. The operation of equipment installed on governmental or other authorized emergency operation and for the safety of the public is excluded from the provisions of this Section.

C. Modification of Vehicular Equipment. No persons shall modify or change the exhaust muffler, intake muffler or any other noise abatement device of a vehicle in such a manner that the noise emitted by the vehicle is increased above that emitted by the vehicle as originally manufactured.

D. Enforcement. It shall be the duty of the Chief of Police or his duly authorized representatives to enforce the provisions of this Section and the rules and regulations adopted by the Health Officer pursuant thereto.

E. Rules and Regulations Pertaining to the Control of Traffic Noises. The following practices and acts are prohibited regardless of decibel measurement.

1. No vehicle shall be operated in such a manner as to produce loud and unnecessary squealing of tires.
2. No vehicle shall sound its horn, bell, or other signaling device except as a danger of cautionary warning. Such warning shall only be sounded for a reasonable and necessary period of time.
3. No person shall race the engine of a vehicle in such a manner as to produce unreasonably loud and unnecessary engine noises.
4. In addition to the above, all sections within this Ordinance will be applied to motor vehicles where applicable.

23.14 SALE, DISTRIBUTION, LEASE OR RENTAL OF NOISY EQUIPMENT

A. Sale, Rental, Etc. of Equipment. No person shall sell offer, distribute, lease or rent any new or used vehicle, device or equipment intended for use within the limits of the City of Kenosha which does not comply with the provisions of this Chapter or with rules and regulations adopted by the Health Officer pursuant to the provisions of this Chapter or with any Federal or State standards which apply to such equipment and are intended to reduce or minimize the noise emission from such equipment or device.

B. Rules and Regulations. The Health Officer is empowered to propose rules and regulations relative to the sale, distribution, rental or lease of new and used vehicles, devices and equipment which emit noise for the purpose of limiting such noise emission to the lowest practical level. Such rules shall be reasonably consistent with federal and state standards which regulate the noise emission of such equipment and devices. These rules shall have the same force and effect as law and shall be enforced in accordance with the provisions of this Chapter. The Health Officer shall submit a copy of the rules and regulations to the Common Council for approval prior to final adoption of the same. He shall file a copy of the adopted rules and regulations in the office of the City Clerk.

23.15 CITY CONTRACTS AND PURCHASES

Compliance of City Contractors and Subcontractors. It is the policy of the City of Kenosha to comply with the noise emission standards, as set forth in this Chapter, in its own operations and the

operations of the contractors and subcontractors. All contractors and subcontractors shall be notified of and required to comply with the provisions of this Ordinance.

A. City Purchases. It is the policy of the City of Kenosha to purchase only equipment which complies to the standards established for the same by this Ordinance.

23.16 SCHOOLS, HOSPITALS AND CHURCHES

It shall be unlawful for any person to create any "noise" on any street, sidewalk or public place adjacent to any hospital or to any school, institution of learning or church while the same is in use, provided conspicuous signs are displayed in such streets, sidewalks or public place indicating the presence of a school, church or hospital.

23.17 APPEALS

Any person aggrieved by the denial of an application by the Health Officer for an exemption of variance from the provisions of this Chapter shall have the right to appeal therefrom to the Board of Health, provided a written request therefor is filed with the Secretary of the Board of Health within ten (10) days after receipt of the notice of such denial. The Board of Health, after a hearing on such appeal, may affirm, modify or overrule the denial from which the appeal is made.

23.18 INJUNCTION: ADDITIONAL REMEDY

The operation or maintenance of any device, instrument, vehicle or machinery in violation of any provision of this Chapter, which causes harm, discomfort, or annoyance to reasonable persons of normal sensitiveness or which endangers the public health, safety, welfare, comfort, repose, peace and prosperity of persons in the area shall be deemed, and is declared to be, a public nuisance and may be subject to abatement by a restraining order or injunction issued by a court of competent jurisdiction. This is not intended to preclude resort to any other legal remedy.

23.19 PENALTY

The present penalty in Chapter IV, Ordinances, is adopted by reference.

23.20 SEVERABILITY

If any provision, clause, sentence, or paragraph of this Chapter, or the application thereof to any person or circumstances, shall be held invalid, such invalidity shall not affect the other provisions or application of the provisions of this Chapter which can be given effect without the invalid provisions or application and to this end, the provisions of this Chapter are hereby declared to be severable.

CHAPTER XXIV
LANDLORD'S RIGHTS

24.01 LANDLORDS' RIGHTS

A. Purpose. The purpose of this Ordinance is to protect the property interests of landlords from abuse by tenants. In accomplishing this purpose, landlords are assured the right to reject as tenants those persons who have a history or record of behavior which demonstrates a lack of respect for property. This Ordinance is also intended to promote the reasonable use and the peaceful enjoyment of rental property.

B. Construction.

1. This Ordinance shall be construed so as to modify or repeal anything in Chapter XXII inconsistent herewith, where such interpretation is not inconsistent with State law.

2. Subsections C. and E. herein shall confer rights on landlords only where this Ordinance is not used as a subterfuge to evade discriminatory practices prohibited in §22.02 C., Ordinances.

3. The City Attorney is not required to prosecute apparent violations of Chapter XXII where there is not a real case in controversy.

C. Landlords' Rights. Landlords shall have the following rights:

1. To demand and check the references of proposed tenants.

2. To reject as a tenant any person(s) who cannot demonstrate, where applicable, a history or record of prompt rental or mortgage payments and due and proper care in the maintenance of a previously occupied dwelling unit, as defined in Chapter XVI or who does not authorize, upon request, the release of personal credit bureau information.

3. To provide in the terms of a lease that if during the term thereof the tenant negligently or intentionally damages the rental property that the landlord, as an alternative to terminating the tenancy, may use escrow monies to repair the damage and require forthwith that the tenant pay such monies to the landlord as will fully pay for all damages, even if over the amount of any escrow fund, and as will reimburse the escrow account for any monies deducted therefrom.

4. To reject as a tenant any person(s) where rental of a dwelling unit would result in:

a. The habitation of a dwelling unit by adults of the opposite sex unmarried to each other and unrelated to each other by a relationship more distant than first cousins, under circumstances which would violate State Law.

b. The habitation of a dwelling unit intended for one family by two or more families.

c. The habitation of a dwelling unit contrary to the minimum space and use requirements of Chapter XVI.

d. Children residing in owner occupied buildings having four or less rental units, where the owner has no children residing in said building, and totally prohibits children in the remaining units.

e. Rental of a dwelling unit to a person(s) who has no apparent ability to pay the specified monthly rent. Guidelines of lending institutions shall be relevant in determining the maximum percentage of a person's monthly income which is available for housing purposes. Money held in savings accounts or invested in bonds or securities which are readily convertible into cash shall be considered in determining ability to pay.

5. To enter the rental premises of any tenant during the tenancy to inspect the premises, make repairs, or show the premises to prospective tenants or purchasers, as authorized under §704.05(2), Wisconsin Statutes, at reasonable times upon twelve (12) hours advance notice. Entry may be upon less than twelve (12) hours advance notice where the tenant, upon being notified of the proposed entry, consents to a shorter time, where the tenant requests or consents to a proposed entry at a specified time, where a health or safety emergency exists, where the tenant is absent and the landlord reasonably believes that entry is necessary to protect the premises from damage or where entry is otherwise authorized in writing other than in a form provision in a lease.

D. Prohibited Practices of Applicants. Applicants for rental units are prohibited from intentionally making incomplete or fraudulent rental applications.

An application shall not be considered incomplete or fraudulent under circumstances wherein the applicant does not intend to rent any unit for which application is made.

E. NonDiscriminatory Reasons for Eviction. Tenants may be evicted for, but not limited to the following reasons, which reasons shall constitute a prima facie case of lack of discrimination:

1. The intentional, malicious or grossly negligent maintenance of the dwelling unit.
2. Living in a condition of filth such as to create an environment for rodents, insects or disease.
3. Wasting heat and utilities provided by the landlord.
4. Engaging in conduct detrimental to the safety and welfare of the landlord or other tenants or interfering with the peaceful enjoyment of their premises, where said conduct is not protected by Chapter Ag 134, Wisconsin Administrative Code which is incorporated herein by reference, as it now exists and as it may be amended in the future.
5. Keeping or storing vehicles, contrary to City Ordinances.
6. Engaging in any conduct contrary to City Ordinances or State laws or refusing to obey the lawful orders of the County Health, City Police or Fire personnel.
7. Conduct contrary to Subsections C.4.a. through d. of this Ordinance.

F. Penalty. Any person who shall violate Subsection D. hereof shall, upon conviction thereof, forfeit not more than Two Hundred (\$200) Dollars, plus the costs of prosecution, and in default of payment thereof, shall be imprisoned in the County Jail until said forfeiture and costs are paid, but not for a period exceeding thirty (30) days.

CHAPTER XXV
MINIMUM STANDARDS, REQUIREMENTS AND QUALIFICATIONS
FOR COMMERCIAL SERVICE OPERATORS AT THE KENOSHA REGIONAL AIRPORT

25.01 PURPOSE

The purpose of this Ordinance is to:

- A.** Impose minimum standards, requirements and qualifications which establish the threshold entry criteria for Commercial Service Operators at Kenosha Regional Airport.
- B.** Establish contractual requirements for Commercial Service Operators at Kenosha Regional Airport.
- C.** Establish a qualification review process for those wishing to become Commercial Service Operators at Kenosha Regional Airport which affords a fair and reasonable opportunity to compete for available Airport land and facilities.
- D.** Establish a policy for the setting of uniform fees and establishment of a uniform rental structure at Kenosha Regional Airport.
- E.** Designate responsibility for administration of this Ordinance in accordance with Federal and State laws, rules, regulations, and grant assurances.
- F.** Enhance demand for products and services at Kenosha Regional Airport.
- G.** Provide opportunity for Kenosha Regional Airport to fulfill its development potential.
- H.** Provide opportunity for Kenosha Regional Airport to operate as a self sustaining business enterprise.
- I.** Encourage Commercial Service Operators to exceed the minimum standards, requirements and qualifications of this Ordinance.

25.02 DEFINITIONS

The following words and terms, for purposes of this Ordinance, have the meaning below provided.

"Aeronautical Services" means any service which involves, makes possible, or is required for the operation of aircraft, or which contributes to or is required for the safety of aircraft operation.

"Agricultural Land" means property owned by City that is not presently needed for Airport use and is available for agrarian leases as an interim use.

"Airport" means Kenosha Regional Airport operated by City and located in the City of Kenosha, Wisconsin.

"Airport Director" means the person employed by City to administer the policies of and manage the day-to-day operations of Airport.

"Airport Facilities" means land, buildings, and structures owned and controlled by City, located at Airport.

"Based Aircraft" means aircraft which are hangared or parked at Airport.

"City" means City of Kenosha.

"Commercial Aeronautical Service" means the performance of Aeronautical Services at Airport for the purpose of securing earnings, income, compensation, or profit, whether or not the business venture is profitable.

"Commercial Service" means Commercial Aeronautical Service and/or NonAeronautical Service.

"Commercial Service Operator" or **"Operator"** means any person providing any one or a combination of Commercial Aeronautical or NonAeronautical Services at Airport.

"Commission" means an Airport Commission organized and existing under authority of Section

CODE OF GENERAL ORDINANCES, 2020 - KENOSHA, WISCONSIN

114.14, Wisconsin Statutes.

"Community Hangars" means a single aircraft hangar unit designed to house multiple aircraft of the same or different ownership.

"Co-op Fueling" means the self-fueling of aircraft through an organization formed by several aircraft owners.

"FAA" means the Federal Aviation Administration.

"Flying Club" means a nonprofit corporation or partnership in which each member is a stockholder or has an ownership interest in the aircraft under circumstances where revenue does not exceed the amount necessary for aircraft operation, maintenance and replacement, and where aircraft may not be used or rented other than by members.

"Hangar" means a building or structure housing one (1) or more aircraft where no Commercial Aviation Services are performed or offered in that building or structure at Airport.

"Major Repair or Alteration" means those repairs to aircraft or installation of aviation parts and accessories considered major by the FAA and so defined under its regulations.

"Multiple T-Hangar" means an aircraft hangar composed of partitioned, nested units designed to house aircraft in each unit and having a single door opening.

"NonAeronautical Service" means the performance of Commercial Services which are not aviation related but are beneficial to Airport operation, for the purpose of securing earnings, income, compensation, or profit, whether or not the business venture is profitable.

"Ordinance" means this Chapter of the City Code of General Ordinances.

"Person" means person, party, firm, corporation, group, association or other legal entity.

"Ramp Permit Area" means an area of ramp used by a Commercial Service Operator for the parking of aircraft in conjunction with its operation.

25.03 RIGHTS AND PRIVILEGES AT KENOSHA REGIONAL AIRPORT

A. Economic Nondiscrimination Policy. To make Airport available to Airport operators and users on an economically nondiscriminatory basis, City adopts the following policy:

1. Airport is available, on reasonable terms and conditions, without unjust discrimination, to any Operator, to conduct Commercial Aeronautical or NonAeronautical Services in accordance with this Ordinance. Airport is not available to any Operator to conduct NonAeronautical services which are unrelated to and do not enhance Airport operation.

2. In any agreement or lease, under which a right or privilege at Airport is granted to any Commercial Service Operator, to conduct or to engage in any Commercial Aeronautical or NonAeronautical Service at Airport, the Commercial Operator shall agree, among other matters, to:

- a. Furnish said services on a reasonable, and not unjustly discriminatory, basis to all users thereof; and,
- b. Charge reasonable, and not unjustly discriminatory, prices for each unit or service, provided that the Commercial Service Operator may be allowed to make reasonable and nondiscriminatory discounts, rebates, or price reductions to volume purchasers.

3. Each Commercial Service Operator at Airport shall be subject to the same fees and rentals, as are uniformly applicable to all other Operators making the same or similar uses of the Airport and using the same or similar land or facilities.

4. Each air carrier using Airport shall have the right to service itself or to use any Commercial Service Operator that is authorized or permitted to operate at Airport.

5. Each air carrier using Airport (whether as a tenant, nontenant, or subtenant of another air carrier tenant) shall be subject to such nondiscriminatory and substantially comparable rules, regulations,

CODE OF GENERAL ORDINANCES, 2020 - KENOSHA, WISCONSIN

conditions, rates, fees, rentals, and other chargers with respect to facilities directly and substantially related to providing air transportation as are applicable to all such air carriers which make similar use of Airport and use similar facilities, subject to reasonable classifications such as tenants or nontenants and signatory carriers and nonsignatory carriers. Classification or status as tenant or signatory shall not be unreasonably withheld by Airport provided an air carrier assumes obligations substantially similar to those already imposed on air carriers in such classification or status.

6. City will not exercise or grant any right or privilege which operates to prevent any person, operating aircraft on the Airport; from performing maintenance and repair services on owned aircraft, by aircraft owner or by aircraft owners employees.

7. City may elect to itself provide Commercial Aeronautical or NonAeronautical Services at Airport provided it does so on the same conditions as would apply to the furnishing of such services by private Commercial Service Operators under this Ordinance.

8. City may establish such reasonable, and not unjustly discriminatory, conditions to be met by all operators of and users of the Airport as may be necessary for the safe and efficient operation of Airport.

9. City may prohibit or limit any given type, kind or class of aeronautical or NonAeronautical use of Airport if such action is necessary for the safe operation of Airport or for the public convenience or necessity.

10. City Airport Director or Commission may restrict nonessential personnel from accessing aeronautical operations areas at Airport.

11. Nothing contained herein shall prevent Airport from phasing in fees, and rent or imposing different fees and rent for different classifications of operators, land or facilities or from recovering its costs of operation.

B. Exclusive Rights and Privileges Prohibited. City will not, either directly or indirectly, grant any person, the exclusive right or privilege to conduct any Commercial Aeronautical Services.

For purposes of this Section, the providing of Commercial Aeronautical Services at Airport by a single Operator shall not be construed as an exclusive right if it would be unreasonably costly, burdensome, or impractical for more than one Fixed-Based Operator to provide such services.

A right or privilege shall not be deemed exclusive because only one person (operator) has sought or been deemed qualified to exercise such right or privilege.

C. Fee And Rental Structure. Airport will maintain a fee and rental structure for Airport which will provide an opportunity for Airport to operate as a self-sustaining business enterprise. No part of the Federal share of an Airport development, Airport planning or noise compatibility project for which a grant is made under Federal law, rule or regulation shall be included in the rate basis in establishing fees and rental structure.

25.04 PROHIBITION

No person shall use Airport or act as a Commercial Service Operator at Airport contrary to the terms and conditions of this Ordinance or contrary to the terms and conditions of any lease or agreement to which they are a party.

25.05 REQUIREMENT

Any person deemed qualified and selected as an operator under the terms of this Ordinance shall, as a condition of operation, enter into a written lease or agreement defining permitted activity, which is negotiated by the Airport Director, drafted or approved by the City Attorney, recommended by the Airport Commission and approved by the Common Council of City.

Upon executing a written lease or agreement, and paying of the prescribed fees and rental charges, an Operator shall have the right and privilege of conducting the operation specified for so long as Operator complies with the terms and conditions of their written lease or agreement, and this Ordinance, and relevant Federal and State laws, rules and regulations.

Nothing contained herein shall limit the right of any aircraft operator to use Airport or the right of aircraft owner or employees of aircraft owner to maintain and repair aircraft to the extent authorized by Federal or State laws, rules or regulations.

The granting of any right and privilege under this Ordinance, however shall not be construed in any way as affording the Operator the exclusive right or privilege of use of Airport, other than the land or facilities which may be leased or reserved exclusively to them, and then only to the extent provided in the written lease or agreement. City reserves and retains the right for the use of Airport by others, pursuant to this Ordinance and applicable Federal and State laws, rules and regulations. City reserves the further right to designate the specific Airport areas in which aeronautical or NonAeronautical services may be conducted. Such designation shall give consideration to the nature and extent of the operation and the lands and facilities available for such purpose, which must be consistent with the safe and efficient operation and orderly development of Airport.

25.06 APPLICATION AND REVIEW OF QUALIFICATIONS OF POTENTIAL OPERATORS

A. Application. Any person desiring to provide a Commercial Aeronautical or NonAeronautical Service at Airport make and file a written application for such operation and submit to a review of their qualifications as hereinafter provided.

The application shall:

1. Be fully, completely, accurately, legibly and truthfully completed.
2. Be on City forms, where and to the extent available.
3. Describe the nature of the proposed business, and include a business plan, where available. Where a business plan is not available, City Airport Director, Commission or Common Council may require a business plan be developed and submitted for review.
4. Include an Affidavit of Organization and Authority and Careful Inspection of Site and preparation of application.
5. Be signed by persons having legal authority to bind applicant and execute a lease or agreement. Every signatory must identify his/her title and office or position in applicant's business. City may require corporations to adopt resolutions authorizing execution of lease or agreement.
6. Identify land or facilities sought and buildings and hangars to be acquired or constructed.
7. List critical dates related to commencement of operation.
8. List product, and services to be offered.
9. State name of owner or proprietor. List all persons and parties having an interest of ten (10%) percent or more in the business. Where a partnership, list all partners. Where a corporation, list all officers and directors.
10. Provide a current financial statement prepared by a Certified Public Accountant.
11. Provide a written authorization from the FAA and any aviation or aeronautics commissions, administrators, and departments of all states in which the applicant or any person or party having an

interest of ten (10%) percent or more in the business, has provided Commercial Aeronautical Services to release information in their files to City relating to the applicant or applicants's operations. The applicant must execute such forms, releases, or discharges as may be required by those agencies.

12. Provide preliminary plans and specifications for any improvements which the applicant desires to make on Airport.

13. Provide proof of required insurance or insurability.

14. Provide such other information as the Airport Director, Commission or Common Council may require. Commission or Common Council, for good cause, may waive any requirement or irregularity in the application process.

B. City Rights Reserved. City, in reviewing an application, reserves the right to:

1. Independently verify applicants representations, financial condition, and business background.

2. Obtain a credit report on applicant.

3. Require preliminary approval of any proposed financing.

4. Request additional information, data and reports.

5. Decline to review an incomplete application.

6. Suspend or terminate review of an application at any time it does not have the full cooperation of applicant, including but not limited to providing required or requested information, and attendance of applicant at meetings of the Commission and/or Common Council.

C. Time for Review. The Airport Commission will review and make a recommendation respecting application to City Common Council within ninety (90) days, of receipt of a fully completed application, but time is not of the essence. The Common Council, upon obtaining such recommendation, will act thereon as soon as practical.

D. Standard for Review.

1. Basis for Approval. An application may be approved when in the best interest of Airport.

2. Basis for Denial. An application may be denied, as not being in the best interest of Airport, where:

a. Applicant does not meet the minimum standards, requirements, and qualification of this Ordinance or of Federal or State laws, rules, or regulations.

b. There is inadequate land, facilities, and/or infrastructure available at Airport for applicant's business at the time of application. City has no obligation to acquire land or construct improvements to provide land or facilities for development.

c. The applicant's proposed operation will be detrimental to the public health, safety, and welfare.

d. The proposed operation does not comply with the Airport Layout Plan, as approved and amended from time to time.

e. The proposed operation will result in a congestion of aircraft, or buildings.

f. The proposed operation will unduly interfere with another operator or user or block or obstruct access by others to common or operational areas of Airport.

g. Applicant has failed to file an application or provide information, or attend meetings of the Commission and/or Common Council in conformance with this Ordinance.

h. Applicant has, in the application, or during the application process, made a material statement which is false or misleading.

i. Persons having an ownership interest of ten (10%) percent or more, partners or persons serving as a corporate officer or director have a material record of violating Federal, State or local laws, rules or regulations or a record of unethical business practices, or related court or administrative proceedings are pending.

j. Applicant has a record of default in performance of leases and agreements with Airport, other airports, or other parties.

- k. Applicant is not credit worthy or has not demonstrated the financial ability to perform.
- l. Applicant has not demonstrated sufficient business background or capability to demonstrate project success.
- m. Applicant has not shown proof of insurance or insurability in amounts and coverages required by this Ordinance.

E. Other Requirements. An applicant whose application was approved by the Common Council, may not commence construction of improvements or operation at Airport until:

1. A lease or contract terms have been negotiated.
2. A lease or contract has been drafted or approved by the City Attorney, recommended by the Airport Commission and approved by the Common Council.
3. A lease or contract has been fully executed.
4. Applicant has procured required insurance and filed a Certificate of Insurance with the Airport Director.
5. Applicant has posted required bonds and assurances, if any.
6. Applicant has obtained required land use, Occupancy and Building Permits and other required governmental permits and approvals.

25.07 MINIMUM STANDARDS FOR FIXED BASE OPERATOR

A. Definition. A **Fixed Base Operator** is a person who provides a minimum of six of the following Commercial Aeronautical Services at Airport:

- Aircraft Sales (new or used)
- Airframe and Power Plant Facilities
- Aircraft Rental
- Flight Training
- Aircraft Fueling and Oil Dispensing
- Specialized Aircraft Repair Services
- Aircraft Charter and Air Taxi
- Specialized Commercial Flying Services
- Agricultural Spraying
- T-Hangar and Common Hangar Storage
- Air Cargo
- Aircraft Painting
- Aircraft Upholstery
- Scheduled Air Carrier or Scheduled Air Taxi
- Sale of Pilot Supplies
- Sale of Aircraft Parts

Only a Fixed Base Operator can engage in Aircraft Fueling and Oil Dispensing to the public, for profit. This requirement may be waived, but only under circumstances where there would be no aircraft fueling and oil dispensing at Airport, absent a waiver.

B. Minimum Standards and Requirements. A Fixed Base Operator, as a condition of being permitted to operate at Airport, shall:

1. Lease a minimum of 40,000 square feet of ground space.
2. Provide a building with a minimum of 14,400 square feet of floor space for aircraft storage, repair and maintenance, office, customer lounge, and restrooms; all properly heated and lighted.
3. Lease aircraft parking ramp area adequate for operation, as determined by the Commission and

obtain aircraft Parking Ramp Permit.

4. Provide paved vehicle parking within the leased area adequate for operations, as determined by Commission.

5. Provide a paved walkway within the leased area to accommodate pedestrian access to the operators office.

6. Provide a paved aircraft apron within the leased area to accommodate aircraft movement from the operators land or buildings to the taxiway or to the access to the taxiway that is provided by Owner.

7. Be open for business during days and hours specified in a business plan for each Commercial Service approved by Commission.

8. Have on duty personnel in sufficient number and with sufficient training and experience and FAA rating to provide an adequate level of service to its customers for each Commercial Service.

9. Have equipment and supplies on hand to provide an adequate level of service to its customers for each Commercial Service.

10. Provide office, training and reception areas adequate for services offered.

11. Segregate any painting area from other operations.

12. Meet any additional minimum standards and requirements of this Ordinance for each particular Commercial Service offered.

13. Use leased premises and provide Commercial Services in accordance with any other applicable Federal, State or local law, rule or regulation.

Nothing contained herein shall be interpreted to require each Commercial Service to be provided through separate or independent facilities, equipment or personnel.

C. Insurance Policies. Operator shall procure and maintain, during the term of any lease or agreement the insurance policies hereinafter specified. Said policies must be issued by an insurance company or companies authorized to do business in the State of Wisconsin and licensed by the Insurance Department of the State. Operator shall furnish a Certificate of Insurance indicating compliance with the foregoing, including the naming of City as an "additional insured", and proof of payment of premium to the Airport Director for approval. The insurance policy or policies shall contain a clause that in the event that any policy issued is canceled or terminated for any reason, or any material changes are made therein, the Airport Director will be notified, in writing, by the insurer at least thirty (30) days before any cancellation, termination or change takes effect. If for any reason, the insurance coverage required herein lapses, City Common Council may declare the lease or agreement null and void as of the date no valid insurance policy was in effect. Certificates of policy renewals shall be furnished to the Airport Director throughout the term of Lease.

The following insurance coverages shall be obtained and continue in effect during the term of the lease or agreement in not less than the amounts specified:

- Worker's Compensation - Statutory - In compliance with the Worker's Compensation Law of the State of Wisconsin;
- General Liability Insurance with a minimum limit of One Million (\$1,000,000.00) Dollars per occurrence and One Million (\$1,000,000.00) Dollars per passenger seat, where applicable, having the following coverages:
 - Premises and Operations, including Hangarkeepers;
 - Independent Contractor and Subcontractors;
 - Products and Completed Operations;
 - Contractual; and,
 - Death and Personal Injury.
- Automobile Liability Insurance with a minimum single limit of liability of One Million (\$1,000,000.00) Dollars for death and bodily injury, and Five Hundred Thousand (\$500,000.00) Dollars for property damage, having the following coverages:

Owned Automobiles;
Hired Automobiles; and,
Non-owned Automobiles.

Where aviation fuel or other petroleum product is dispensed on leased premises, environmental liability (pollution) insurance coverage, with a minimum limit of One Million (\$1,000,000.00) Dollars, is required, including third party bodily injury and property damage protection and resulting cleanup, as a consequence of fuel spill, overfill, leak accident or other event from underground/aboveground storage tanks or fueling or petroleum dispensing trucks.

25.08 MINIMUM STANDARDS FOR AIRFRAME AND POWER PLANT OPERATOR

A. Definition. An **Airframe and Power Plant Operator** is a person who provides the following Commercial Aeronautical Services at Airport:

Aircraft engine and airframe maintenance and repair
(Incidental sale of aircraft parts and accessories is permitted as a companion use).

B. Minimum Standards And Requirements. An Airframe and Power Plant Operator, as a condition of being permitted to operate at Airport, shall:

1. Lease a minimum of 13,500 square feet of ground space.
2. Provide a building with a minimum of 6,000 square feet of floor space for aircraft storage, repair and maintenance, office, customer lounge, and restrooms; all properly heated and lighted.
3. Lease aircraft parking ramp area adequate for operation, as determined by the Commission and obtain aircraft Parking Ramp Permit.
4. Provide paved vehicle parking within the leased area adequate for operations, as determined by Commission.
5. Provide a paved walkway within the leased area to accommodate pedestrian access to the operators office.
6. Provide a paved aircraft apron within the leased area to accommodate aircraft movement from the operators land or buildings to the taxiway or to the access to the taxiway that is provided by Owner.
7. Be open for business during days and hours specified in a business plan approved by Commission.
8. Have on-duty personnel in sufficient number and with sufficient training and experience and FAA rating to provide an adequate level of service to its customers.
9. Have equipment and supplies on hand to provide an adequate level of service to its customers.
10. Provide office, training and reception areas adequate for services offered.
11. Segregate any painting area from other operations.
12. Use leased premises and provide Commercial Services in accordance with any other applicable Federal, State or local law, rule or regulation.

C. Insurance Policies. Operator shall procure and maintain, during the term of any lease or agreement the insurance policies hereinafter specified. Said policies must be issued by an insurance company or companies authorized to do business in the State of Wisconsin and licensed by the Insurance Department of the State. Operator shall furnish a Certificate of Insurance indicating compliance with the foregoing, including the naming of City as an "additional insured", and proof of payment of premium to the Airport Director for approval. The insurance policy or policies shall contain a clause that in the event that any policy issued is canceled or terminated for any reason, or any material changes are made therein, the Airport Director will be notified, in writing, by the insurer at least thirty (30) days before any cancellation, termination or change takes effect. If for any reason, the insurance coverage required herein lapses, City Common Council may declare the lease or agreement null and void as of the date no valid insurance

policy was in effect. Certificates of policy renewals shall be furnished to the Airport Director throughout the term of Lease.

The following insurance coverages shall be obtained and continue in effect during the term of the lease or agreement in not less than the amounts specified:

- Worker's Compensation - Statutory - In compliance with the Worker's Compensation Law of the State of Wisconsin;
- General Liability Insurance with a minimum limit of One Million (\$1,000,000.00) Dollars per occurrence having the following coverages:
Premises and Operations, including Hangarkeepers;
Independent Contractor and Subcontractors;
Products and Completed Operations;
Contractual; and,
Death and Personal Injury.
- Automobile Liability Insurance with a minimum single limit of liability of One Million (\$1,000,000.00) Dollars for death and bodily injury, and Five Hundred Thousand (\$500,000.00) Dollars for property damage, having the following coverages:
Owned Automobiles;
Hired Automobiles; and,
Non-owned Automobiles.

25.09 MINIMUM STANDARDS FOR AIRCRAFT RENTAL OPERATOR

A. Definition. An **Aircraft Rental Operator** is a person who provides the following Commercial Aeronautical Services at Airport:

Aircraft Rental to the public, subject to appropriate aviation licenses, (Flight training is permitted as a companion use).

B. Minimum Standards And Requirements. An Aircraft Rental Operator, as a condition of being permitted to operate at Airport, shall:

1. Lease a minimum of 12,500 square feet of ground space.
2. Provide a building with a minimum of 4,500 square feet of floor space for aircraft storage, repair and maintenance, office, customer lounge, and restrooms; all properly heated and lighted.
3. Lease aircraft parking ramp area adequate for operation, as determined by the Commission and obtain aircraft Parking Ramp Permit.
4. Provide paved vehicle parking within the leased area adequate for operations, as determined by Commission.
5. Provide a paved walkway within the leased area to accommodate pedestrian access to the operators office.
6. Provide a paved aircraft apron within the leased area to accommodate aircraft movement from the operators land or buildings to the taxiway or to the access to the taxiway that is provided by Owner.
7. Be open for business during days and hours specified in a business plan approved by Commission.
8. Have on-duty personnel in sufficient number and with sufficient training and experience and FAA rating to provide an adequate level of service to its customers and check out qualifications of rental applicants.
9. Have equipment and supplies on hand to provide an adequate level of service to its customers.
10. Provide office and reception areas adequate for services offered.
11. Have available for rental at least one (1) aircraft (owner or leased) based at Airport which is certified and airworthy.

12. Use leased premises and provide Commercial Services in accordance with any other applicable Federal, State or local law, rule or regulation.

C. Insurance Policies. Operator shall procure and maintain, during the term of any lease or agreement the insurance policies hereinafter specified. Said policies must be issued by an insurance company or companies authorized to do business in the State of Wisconsin and licensed by the Insurance Department of the State. Operator shall furnish a Certificate of Insurance indicating compliance with the foregoing, including the naming of City as an "additional insured", and proof of payment of premium to the Airport Director for approval. The insurance policy or policies shall contain a clause that in the event that any policy issued is canceled or terminated for any reason, or any material changes are made therein, the Airport Director will be notified, in writing, by the insurer at least thirty (30) days before any cancellation, termination or change takes effect. If for any reason, the insurance coverage required herein lapses, City Common Council may declare the lease or agreement null and void as of the date no valid insurance policy was in effect. Certificates of policy renewals shall be furnished to the Airport Director throughout the term of Lease.

The following insurance coverages shall be obtained and continue in effect during the term of the lease or agreement in not less than the amounts specified:

- Worker's Compensation - Statutory - In compliance with the Worker's Compensation Law of the State of Wisconsin;
- General Liability Insurance with a minimum limit of One Million (\$1,000,000.00) Dollars per occurrence having the following coverages:
 - Premises and Operations, including Hangarkeepers;
 - Independent Contractor and Subcontractors;
 - Products and Completed Operations;
 - Contractual; and,
 - Death and Personal Injury.

25.10 MINIMUM STANDARDS FOR FLIGHT TRAINING OPERATOR

A. Definition. A **Flight Training Operator** is a person who provide the following Commercial Aeronautical Service at Airport:

Flight Training to the general public.

B. Minimum Standards and Requirements. A Flight Training Operator, as a condition of being permitted to operate at Airport, shall:

1. Lease a minimum of 12,500 square feet of ground space.
2. Provide a building with a minimum of 4,500 square feet of floor space for aircraft storage, repair and maintenance, office, customer lounge, and restrooms, all properly heated and lighted.
3. Lease aircraft parking ramp area adequate for operation, as determined by the Commission and obtain aircraft Parking Ramp Permit.
4. Provide paved vehicle parking within the leased area adequate for operations, as determined by Commission.
5. Provide a paved walkway within the leased area to accommodate pedestrian access to the operators office.
6. Provide a paved aircraft apron within the leased area to accommodate aircraft movement from the operator's land or buildings to the taxiway or to the access to the taxiway that is provided by Owner.
7. Be open for business during days and hours specified in a business plan approved by Commission.
8. Have on-duty personnel in sufficient number and with sufficient training and experience and FAA rating to provide an adequate level of service to its customers and check out qualifications of rental

applicants.

9. Have equipment and supplies on hand to provide an adequate level of service to its customers.
10. Provide office and reception areas adequate for services offered.
11. Have available for rental at least one (1) aircraft (owner or leased) based at Airport which is certified and airworthy.
12. Use leased premises and provide Commercial Services in accordance with any other applicable Federal, State or local law, rule or regulation.

C. Insurance Policies. Operator shall procure and maintain, during the term of any lease or agreement the insurance policies hereinafter specified. Said policies must be issued by an insurance company or companies authorized to do business in the State of Wisconsin and licensed by the Insurance Department of the State. Operator shall furnish a Certificate of Insurance indicating compliance with the foregoing, including the naming of City as an "additional insured", and proof of payment of premium to the Airport Director for approval. The insurance policy or policies shall contain a clause that in the event that any policy issued is canceled or terminated for any reason, or any material changes are made therein, the Airport Director will be notified, in writing, by the insurer at least thirty (30) days before any cancellation, termination or change takes effect. If for any reason, the insurance coverage required herein lapses, City Common Council may declare the lease or agreement null and void as of the date no valid insurance policy was in effect. Certificates of policy renewals shall be furnished to the Airport Director throughout the term of Lease.

The following insurance coverages shall be obtained and continue in effect during the term of the lease or agreement in not less than the amounts specified:

- Worker's Compensation - Statutory - In compliance with the Worker's Compensation Law of the State of Wisconsin;
- General Liability Insurance with a minimum limit of One Million (\$1,000,000.00) Dollars per occurrence having the following coverages:
Premises and Operations, including Hangarkeepers;
Independent Contractor and Subcontractors;
Products and Completed Operations;
Contractual; and,
Death and Personal Injury.

25.11 MINIMUM STANDARDS FOR AIRCRAFT FUEL DISPENSING OPERATOR

A. Definition. An **Aircraft Fuel Dispensing Operator** is a person who provides the following Commercial Aeronautical Service at Airport:

Into plane delivery of quality aviation fuel, lubricants and petroleum based products. (Related service such as window washing; ramp assistance with starters, power units; heaters and fire extinguishers; towing and aircraft parking is permitted).

B. Minimum Standards and Requirements. An Aircraft Fuel Dispensing Operator, as a condition of being permitted to operate at Airport, shall:

1. Meet the minimum standards for a Fixed Base Operator.
2. Have business open for aircraft fueling and oil dispensing service twelve (12) hours per day, seven (7) days per week, excepting holidays approved in advance by the Airport Director. The Operator shall make provisions for such service after regular hours on a call basis. Automated fuel dispensing equipment available to the public may be utilized in lieu of the above minimum hours of operation upon approval of the Airport Commission. The size and location of fueling and oil dispensing equipment shall be determined by the Commission.
3. Provide at least 10,000 gallons of fuel storage for each type of fuel and maintain an adequate

supply of quality fuel on hand.

4. Provide a metered, filter-equipped dispenser, fixed or mobile, which meets all Federal, State and local laws, rules and regulations for the dispensing of fuel.
5. All locations and types of fuel storage will be approved by the Commission.
6. Employ trained personnel approved for the dispensing of aviation fuel in accordance with F.A.A. guidelines.
7. Pay the current fuel flowage and tank fees as determined by the Commission.
8. Use leased premises and provide Commercial Services in accordance with any other applicable Federal, State or local law, rule or regulation.

C. Insurance Policies. Operator shall procure and maintain, during the term of any lease or agreement the insurance policies hereinafter specified. Said policies must be issued by an insurance company or companies authorized to do business in the State of Wisconsin and licensed by the Insurance Department of the State. Operator shall furnish a Certificate of Insurance indicating compliance with the foregoing, including the naming of City as an "additional insured", and proof of payment of premium to the Airport Director for approval. The insurance policy or policies shall contain a clause that in the event that any policy issued is canceled or terminated for any reason, or any material changes are made therein, the Airport Director will be notified, in writing, by the insurer at least thirty (30) days before any cancellation, termination or change takes effect. If for any reason, the insurance coverage required herein lapses, City Common Council may declare the lease or agreement null and void as of the date no valid insurance policy was in effect. Certificates of policy renewals shall be furnished to the Airport Director throughout the term of Lease.

The following insurance coverages shall be obtained and continue in effect during the term of the lease or agreement in not less than the amounts specified:

- Worker's Compensation - Statutory - In compliance with the Worker's Compensation Law of the State of Wisconsin;
- General Liability Insurance with a minimum limit of One Million (\$1,000,000.00) Dollars per occurrence having the following coverages:
 - Premises and Operations, including Hangarkeepers;
 - Independent Contractor and Subcontractors;
 - Products and Completed Operations;
 - Contractual; and,
 - Death and Personal Injury.

Where aviation fuel or other petroleum product is dispensed on leased premises, environmental liability (pollution) insurance coverage, with a minimum limit of One Million (\$1,000,000.00) Dollars, is required, including third party bodily injury and property damage protection and resulting cleanup, as a consequence of fuel spill, overfill, leak accident or other event from underground/aboveground storage tanks or fueling or petroleum dispensing trucks.

25.12 MINIMUM STANDARDS FOR SELF-FUELING OPERATOR

A. Definition. A **Self-Fueling Operator** is a person who provides the following Commercial Aeronautical Service at Airport:

Fueling of aircraft owned, leased, managed or operated by Operator. (Fuel may not be dispensed to the general public, or to others for profit. Cooperative fueling, as defined herein, is prohibited.)

B. Minimum Standards And Requirements. A Self-Fueling Operator, as a condition of being permitted to operate at Airport, shall:

1. Lease a minimum of 40,000 square feet of ground space.

2. Provide a building with a minimum of 14,400 square feet of floor space for aircraft storage, office, and restrooms, all properly heated and lighted.
3. Lease aircraft parking ramp area adequate for operation, as determined by the Commission, and obtain Aircraft Parking Ramp Permit.
4. Provide paved vehicle parking within the leased area adequate for operations, as determined by the Commission.
5. Provide a paved walkway within the leased area to accommodate pedestrian access to the Operator's office.
6. Provide a paved aircraft apron within the leased area to accommodate aircraft movement from the Operator's land or buildings to the taxiway or to the access to the taxiway that is provided by Owner.
7. Provide at least 10,000 gallons of fuel storage for each type of fuel.
8. Provide metered, filter-equipped dispenser, fixed or mobile, which meets all Federal, State and local laws, rules and regulations for the dispensing of fuel.
9. All locations and types of fuel storage will be approved by the Airport Commission.
10. Employ trained personnel approved for the dispensing of aviation fuel in accordance with F.A.A. guidelines.
11. Pay the current fuel flowage and tank fees as determined by the Commission.
12. Use leased premises and provide Commercial Services in accordance with any other applicable Federal, State or local law, rule or regulation.

C. Insurance Policies. Operator shall procure and maintain, during the term of any lease or agreement the insurance policies hereinafter specified. Said policies must be issued by an insurance company or companies authorized to do business in the State of Wisconsin and licensed by the Insurance Department of the State. Operator shall furnish a Certificate of Insurance indicating compliance with the foregoing, including the naming of City as an "additional insured", and proof of payment of premium to the Airport Director for approval. The insurance policy or policies shall contain a clause that in the event that any policy issued is canceled or terminated for any reason, or any material changes are made therein, the Airport Director will be notified, in writing, by the insurer at least thirty (30) days before any cancellation, termination or change takes effect. If for any reason, the insurance coverage required herein lapses, City Common Council may declare the lease or agreement null and void as of the date no valid insurance policy was in effect. Certificates of policy renewals shall be furnished to the Airport Director throughout the term of Lease.

The following insurance coverages shall be obtained and continue in effect during the term of the lease or agreement in not less than the amounts specified:

- Worker's Compensation - Statutory - In compliance with the Worker's Compensation Law of the State of Wisconsin;
- General Liability Insurance with a minimum limit of One Million (\$1,000,000.00) Dollars per occurrence having the following coverages:
 - Premises and Operations, including Hangarkeepers;
 - Independent Contractor and Subcontractors;
 - Products and Completed Operations;
 - Contractual; and,
 - Death and Personal Injury.

Where aviation fuel or other petroleum product is dispensed on leased premises, environmental liability (pollution) insurance coverage, with a minimum limit of One Million (\$1,000,000.00) Dollars, is required, including third party bodily injury and property damage protection and resulting cleanup, as a consequence of fuel spill, overfill, leak accident or other event from underground/aboveground storage tanks or fueling or petroleum dispensing trucks.

25.13 MINIMUM STANDARDS FOR AIRCRAFT CHARTER AND AIR TAXI OPERATOR

A. Definition. An **Aircraft Charter** and **Air Taxi Operator** is a person who provides the following Commercial Aeronautical Service at Airport:

Air transportation for hire to the general public, on a Charter basis or as an Air Taxi as defined by the F.A.A.

B. Minimum Standards And Requirements. An Aircraft Charter and Air Taxi Operator, as a condition of being permitted to operate at Airport, shall:

1. Lease a minimum of 12,500 square feet of ground space.
2. Provide a building with a minimum of 4,500 square feet of floor space for aircraft storage, office, customer lounge and restrooms, all properly heated and lighted.
3. Lease aircraft parking ramp area adequate for operation, as determined by the Commission, and obtain Aircraft Parking Ramp Permit.
4. Provide paved vehicle parking within the leased area adequate for operations, as determined by the Commission.
5. Provide a paved walkway within the leased area to accommodate pedestrian access to the Operator's office.
6. Provide a paved aircraft apron within the leased area to accommodate aircraft movement from the Operator's land or buildings to the taxiway or to the access to the taxiway that is provided by Owner.
7. The Operator shall be open and have services available eight (8) hours daily, five (5) days per week, except approved holidays. The Operator shall provide on-call service during other hours.
8. Have on-duty personnel in sufficient number and with sufficient training and experience and appropriate F.A.A. rating to provide an adequate level of service to its customers, including at least one (1) F.A.A. certified commercial/instrument rated pilot.
9. Have equipment and supplies on hand to provide an adequate level of service to its customers.
10. Provide office and reception areas adequate for services offered.
11. Have available for service at least one (1) aircraft (owner or leased) based at Airport which is certified (including instrument operation) and airworthy.
12. Use leased premises and provide Commercial Services in accordance with any other applicable Federal, State or local law, rule or regulation.

C. Insurance Policies. Operator shall procure and maintain, during the term of any lease or agreement the insurance policies hereinafter specified. Said policies must be issued by an insurance company or companies authorized to do business in the State of Wisconsin and licensed by the Insurance Department of the State. Operator shall furnish a Certificate of Insurance indicating compliance with the foregoing, including the naming of City as an "additional insured", and proof of payment of premium to the Airport Director for approval. The insurance policy or policies shall contain a clause that in the event that any policy issued is canceled or terminated for any reason, or any material changes are made therein, the Airport Director will be notified, in writing, by the insurer at least thirty (30) days before any cancellation, termination or change takes effect. If for any reason, the insurance coverage required herein lapses, City Common Council may declare the lease or agreement null and void as of the date no valid insurance policy was in effect. Certificates of policy renewals shall be furnished to the Airport Director throughout the term of Lease.

The following insurance coverages shall be obtained and continue in effect during the term of the lease or agreement in not less than the amounts specified:

- Worker's Compensation - Statutory - In compliance with the Worker's Compensation Law of the State of Wisconsin;
- General Liability Insurance with a minimum limit of One Million (\$1,000,000.00) Dollars for each seat per occurrence, and General Liability Insurance with a minimum limit of One Million

(\$1,000,000.00) Dollars, having the following coverages:

Premises and Operations, including Hangarkeepers;
Independent Contractor and Subcontractors;
Products and Completed Operations;
Contractual; and,
Death and Personal Injury.

Where aviation fuel or other petroleum product is dispensed on leased premises, environmental liability (pollution) insurance coverage, with a minimum limit of One Million (\$1,000,000.00) Dollars, is required, including third party bodily injury and property damage protection and resulting cleanup, as a consequence of fuel spill, overfill, leak accident or other event from underground/aboveground storage tanks or fueling or petroleum dispensing trucks.

25.14 MINIMUM STANDARDS FOR AIR CARGO OPERATOR

A. Definition. An **Air Cargo Operator** is a person who provides the following Commercial Aeronautical Service at Airport:

Air Cargo (transportation, handling, loading and unloading of goods).

B. Minimum Standards And Requirements. An Air Cargo Operator, as a condition of being permitted to operate at Airport, shall:

1. Lease a minimum of 20,000 square feet of ground space.
2. Provide a building with a minimum of 6,000 square feet of floor space for aircraft storage, office, customer lounge and restrooms, all properly heated and lighted.
3. Lease aircraft parking ramp area adequate for operation, as determined by the Commission, and obtain Aircraft Parking Ramp Permit.
4. Provide paved vehicle parking within the leased area adequate for operations, as determined by the Commission.
5. Provide a paved walkway within the leased area to accommodate pedestrian access to the Operator's office.
6. Provide a paved aircraft apron within the leased area to accommodate aircraft movement from the Operator's land or buildings to the taxiway or to the access to the taxiway that is provided by Owner.
7. Be open for business during days and hours specified in a business plan approved by Commission (minimum of eight (8) hours a day, five (5) days a week, except holidays).
8. Have on-duty personnel in sufficient number and with sufficient training and experience provide an adequate level of service to its customers.
9. Have equipment and supplies on hand to provide an adequate level of service to its customers.
10. Provide office and reception areas adequate for services offered.
11. Have available for cargo transportation at least one (1) aircraft (owner or leased) based at Airport which is certified (including instrument operation) and airworthy.
12. Use Leased premises and provide Commercial Services in accordance with any other applicable Federal, State or local law, rule or regulation.

C. Insurance Policies. Operator shall procure and maintain, during the term of any lease or agreement the insurance policies hereinafter specified. Said policies must be issued by an insurance company or companies authorized to do business in the State of Wisconsin and licensed by the Insurance Department of the State. Operator shall furnish a Certificate of Insurance indicating compliance with the foregoing, including the naming of City as an "additional insured", and proof of payment of premium to the Airport Director for approval. The insurance policy or policies shall contain a clause that in the event that any policy issued is canceled or terminated for any reason, or any material changes are made therein, the

Airport Director will be notified, in writing, by the insurer at least thirty (30) days before any cancellation, termination or change takes effect. If for any reason, the insurance coverage required herein lapses, City Common Council may declare the lease or agreement null and void as of the date no valid insurance policy was in effect. Certificates of policy renewals shall be furnished to the Airport Director throughout the term of Lease.

The following insurance coverages shall be obtained and continue in effect during the term of the lease or agreement in not less than the amounts specified:

- Worker's Compensation - Statutory - In compliance with the Worker's Compensation Law of the State of Wisconsin;
- General Liability Insurance with a minimum limit of One Million (\$1,000,000.00) Dollars per occurrence having the following coverages:
Premises and Operations, including Hangarkeepers;
Independent Contractor and Subcontractors;
Products and Completed Operations;
Contractual; and,
Death and Personal Injury.

Where aviation fuel or other petroleum product is dispensed on leased premises, environmental liability (pollution) insurance coverage, with a minimum limit of One Million (\$1,000,000.00) Dollars, is required, including third party bodily injury and property damage protection and resulting cleanup, as a consequence of fuel spill, overfill, leak accident or other event from underground/aboveground storage tanks or fueling or petroleum dispensing trucks.

25.15 MINIMUM STANDARDS FOR SCHEDULED AIR CARRIER OR SCHEDULED AIR CARGO OPERATOR

A. Definition. A **Scheduled Air Carrier** or **Scheduled Air Cargo Operator** is a person who provide the following Commercial Aeronautical Services at Airport:
Air Transportation and/or Air Cargo Service to the general public.

B. Minimum Standards and Requirements. A Scheduled Air Carrier and/or Scheduled Air Cargo Operator, as a condition of being permitted to operate at Airport, shall:

1. Lease from the City of Kenosha the appropriate amount of Airport terminal space to provide for ticketing, passenger waiting, and baggage makeup. All improvements to the terminal must be made in accordance with City Ordinances and must be approved by the Airport Commission.
2. Have in attendance at least one (1) person at the ticket counter at least one (1) hour before the first flight until thirty (30) minutes after the last flight of each day of operation.
3. Have in their employ and on duty during business hours, trained personnel in such numbers as are adequate, but never less than one (1) F.A.A. certified Airline Transport Rated Pilot appropriately rated to permit the flight activity offered by the Operator.
4. Be open for business during days and hours specified in a business plan for each Commercial Service approved by Commission.
5. Have on-duty personnel in sufficient number and with sufficient training and experience and F.A.A. rating to provide an adequate level of service to its customers for Commercial Service, including at least one (1) F.A.A. certified Airline Transport rated pilot.
6. Have equipment and supplies on hand to provide an adequate level of service to its customers for each Commercial Service.
7. Nothing contained herein shall be interpreted to require each Commercial Service to be provided through separate or independent facilities, equipment or personnel.
8. Have available for operation at least one (1) aircraft (owner or leased) based at Airport for each

Commercial Service.

9. Use leased premises and provide Commercial Services in accordance with any other applicable Federal, State or local law, rule or regulation.

Nothing contained herein shall be interpreted to require each Commercial Service to be provided through separate or independent facilities, equipment or personnel.

C. Insurance Policies. Operator shall procure and maintain, during the term of any lease or agreement the insurance policies hereinafter specified. Said policies must be issued by an insurance company or companies authorized to do business in the State of Wisconsin and licensed by the Insurance Department of the State. Operator shall furnish a Certificate of Insurance indicating compliance with the foregoing, including the naming of City as an "additional insured", and proof of payment of premium to the Airport Director for approval. The insurance policy or policies shall contain a clause that in the event that any policy issued is canceled or terminated for any reason, or any material changes are made therein, the Airport Director will be notified, in writing, by the insurer at least thirty (30) days before any cancellation, termination or change takes effect. If for any reason, the insurance coverage required herein lapses, City Common Council may declare the lease or agreement null and void as of the date no valid insurance policy was in effect. Certificates of policy renewals shall be furnished to the Airport Director throughout the term of Lease.

The following insurance coverages shall be obtained and continue in effect during the term of the lease or agreement in not less than the amounts specified:

- Worker's Compensation - Statutory - In compliance with the Worker's Compensation Law of the State of Wisconsin;
- General Liability Insurance with a minimum limit of One Million (\$1,000,000.00) Dollars per occurrence for Air Cargo and Carrier Operation, and One Million (\$1,000,000.00) Dollars per seat for Air Carrier Operation having the following coverages:

Premises and Operations, including Hangarkeepers;

Independent Contractor and Subcontractors;

Products and Completed Operations;

Contractual; and,

Death and Personal Injury.

Where aviation fuel or other petroleum product is dispensed on leased premises, environmental liability (pollution) insurance coverage with a minimum limit of One Million (\$1,000,000.00) Dollars, is required, including third party bodily injury and property damage protection and resulting cleanup, as a consequence of fuel spill, overfill, leak accident or other event from underground/aboveground storage tanks or fueling or petroleum dispensing trucks.

25.16 MINIMUM STANDARDS FOR SPECIALIZED COMMERCIAL FLYING OPERATOR

A. Definition. A **Specialized Commercial Flying Operator** is a person who provide the following Commercial Aeronautical Services at Airport:

Air transportation for hire for specialized purposes (not covered elsewhere under the minimum standards of this Ordinance), including, but not limited to, one or more of the following:

1. Nonstop sightseeing flights that begin and end at the same airport.
2. Cropdusting, seeding, spraying and bird chasing.
3. Banner towing and aerial advertising.
4. Aerial photography or survey.
5. Fire fighting.
6. Powerline or pipeline patrol.

7. Any other operations excluded from Part 135, Federal Aviation Regulations.

B. Minimum Standards And Requirements. A Specialized Commercial Flying Operator, as a condition of being permitted to operate at Airport, shall:

1. Because of the variations in the business needs, the square footage and buildings requirements will be discussed with the prospective Operator at the time of his request to perform Commercial Services. Such requirements shall be appropriate to the activity proposed.

In the case of cropdusting, or other commercial use of chemicals, the Operator shall provide a centrally drained, paved area of not less than two thousand (2,000) square feet for aircraft loading, washing, and servicing. Operator shall also provide for the safe storage and containment of noxious chemicals and materials, as well as all ground equipment. Such facilities will be in a location on the Kenosha Regional Airport which will provide the greatest safeguard to the public. Operator shall meet all local, State, and Federal law, rules and regulations pertaining to the Commercial Service provided.

2. Lease aircraft parking ramp area adequate for operation, as determined by the Commission and obtain Aircraft Parking Ramp Permit.

3. Provide paved vehicle parking within the leased area adequate for operations, as determined by Commission.

4. Provide a paved walkway within the leased area to accommodate pedestrian access to the Operator's office.

5. Provide a paved aircraft apron within the leased area to accommodate aircraft movement from the Operator's land or buildings to the taxiway or to the access to the taxiway that is provided by Owner.

6. Be open for business during days and hours specified in a business plan for each Commercial Service approved by Commission.

7. Have on-duty personnel in sufficient number and with sufficient training and experience and F.A.A. rating to provide an adequate level of service to its customers for each Commercial Service.

8. Have equipment and supplies on hand to provide an adequate level of service to its customers for each Commercial Service.

9. Provide office and reception areas necessary for services offered.

10. Have available for operations at least one (1) aircraft (owner or leased) based at Airport which is certified and airworthy, able to provide for each Commercial Service.

11. Use leased premises and provide Commercial Services in accordance with any other applicable Federal, State or local law, rule or regulation.

Nothing contained herein shall be interpreted to require each Commercial Service to be provided through separate or independent facilities, equipment or personnel.

C. Insurance Policies. Operator shall procure and maintain, during the term of any lease or agreement the insurance policies hereinafter specified. Said policies must be issued by an insurance company or companies authorized to do business in the State of Wisconsin and licensed by the Insurance Department of the State. Operator shall furnish a Certificate of Insurance indicating compliance with the foregoing, including the naming of City as an "additional insured", and proof of payment of premium to the Airport Director for approval. The insurance policy or policies shall contain a clause that in the event that any policy issued is canceled or terminated for any reason, or any material changes are made therein, the Airport Director will be notified, in writing, by the insurer at least thirty (30) days before any cancellation, termination or change takes effect. If for any reason, the insurance coverage required herein lapses, City Common Council may declare the lease or agreement null and void as of the date no valid insurance policy was in effect. Certificates of policy renewals shall be furnished to the Airport Director throughout the term of Lease.

The following insurance coverages shall be obtained and continue in effect during the term of the lease or agreement in not less than the amounts specified:

- Worker's Compensation - Statutory - In compliance with the Worker's Compensation Law of the State of Wisconsin;
- General Liability Insurance with a minimum limit of One Million (\$1,000,000.00) Dollars per occurrence, or One Million (\$1,000,000.00) Dollars per passenger seat, where applicable, having the following coverages:
 - Premises and Operations, including Hangarkeepers;
 - Independent Contractor and Subcontractors;
 - Products and Completed Operations;
 - Contractual; and,
 - Death and Personal Injury.

Where aviation fuel or other petroleum product is dispensed on leased premises, environmental liability (pollution) insurance coverage, with a minimum limit of One Million (\$1,000,000.00) Dollars, is required, including third party bodily injury and property damage protection and resulting cleanup, as a consequence of fuel spill, overfill, leak accident or other event from underground/aboveground storage tanks or fueling or petroleum dispensing trucks.

25.17 MINIMUM STANDARDS FOR SPECIALIZED AIRCRAFT REPAIR OPERATOR

A. Definition. A **Specialized Aircraft Repair Operator** is a person who provides the following Commercial Aeronautical Service at Airport:

Repair of aircraft equipment and accessories, including, but not limited to, radios, propellers, and instruments, to include the incidental and nonexclusive sale of new, used and rebuilt equipment and accessories.

B. Minimum Standards and Requirements. A Specialized Aircraft Repair Operator, as a condition of being permitted to operate at Airport, shall:

1. Lease a minimum of 12,500 square feet of ground space.
2. Provide a building with a minimum of 4,500 square feet of floor space for storage, office, customer lounge and restrooms, all properly heated and lighted.
3. Lease aircraft parking ramp area adequate for operation, as determined by the Commission and obtain Aircraft Parking Ramp Permit.
4. Provide paved vehicle parking within the leased area adequate for operations, as determined by Commission.
5. Provide a paved walkway within the leased area to accommodate pedestrian access to the Operator's office.
6. Provide a paved aircraft apron within the leased area to accommodate aircraft movement from the Operator's land or buildings to the taxiway or to the access to the taxiway that is provided by Owner.
7. Be open for business during days and hours specified in a business plan approved by Commission.
8. Have on-duty personnel in sufficient number and with sufficient training and experience and F.A.A. rating to provide an adequate level of service to its customers.
9. Have equipment and supplies on hand to provide an adequate level of service to its customers.
10. Provide office and reception areas adequate for services offered.
11. Use leased premises and provide Commercial Services in accordance with any other applicable Federal, State or local law, rule or regulation.

C. Insurance Policies. Operator shall procure and maintain, during the term of any lease or agreement the insurance policies hereinafter specified. Said policies must be issued by an insurance

company or companies authorized to do business in the State of Wisconsin and licensed by the Insurance Department of the State. Operator shall furnish a Certificate of Insurance indicating compliance with the foregoing, including the naming of City as an "additional insured", and proof of payment of premium to the Airport Director for approval. The insurance policy or policies shall contain a clause that in the event that any policy issued is canceled or terminated for any reason, or any material changes are made therein, the Airport Director will be notified, in writing, by the insurer at least thirty (30) days before any cancellation, termination or change takes effect. If for any reason, the insurance coverage required herein lapses, City Common Council may declare the lease or agreement null and void as of the date no valid insurance policy was in effect. Certificates of policy renewals shall be furnished to the Airport Director throughout the term of Lease.

- The following insurance coverages shall be obtained and continue in effect during the term of the lease or agreement in not less than the amounts specified:
- Worker's Compensation - Statutory - In compliance with the Worker's Compensation Law of the State of Wisconsin;
- General Liability Insurance with a minimum limit of One Million (\$1,000,000.00) Dollars per occurrence having the following coverages, where applicable:
Premises and Operations;
Independent Contractor and Subcontractors;
Products and Completed Operations;
Contractual; and,
Death and Personal Injury.

25.18 MINIMUM STANDARDS FOR AIRCRAFT SALES OPERATOR

A. Definition. An **Aircraft Sales Operator** is a person who provide the following Commercial Aeronautical Service at Airport:

Sale of new and/or used aircraft through franchises or licensed dealership or distributorship (either on a retail or wholesale basis) of an aircraft manufacturer or otherwise, and provides such repair, services, and parts as necessary to meet any guarantee or warranty on new or used aircraft sold by Operator.

B. Minimum Standards And Requirements. An Aircraft Sales Operator, as a condition of being permitted to operate at Airport, shall:

1. Lease a minimum of 12,500 square feet of ground space.
2. Provide a building with a minimum of 4,500 square feet of floor space for aircraft storage, repair and maintenance, office, customer lounge and restrooms, all properly heated and lighted.
3. Lease aircraft parking ramp area adequate for operation, as determined by the Commission and obtain Aircraft Parking Ramp Permit.
4. Provide paved vehicle parking within the leased area adequate for operations, as determined by Commission.
5. Provide a paved walkway within the leased area to accommodate pedestrian access to the Operator's office.
6. Provide a paved aircraft apron within the leased area to accommodate aircraft movement from the Operator's land or buildings to the taxiway or to the access to the taxiway that is provided by Owner.
7. Be open for business during days and hours specified in a business plan approved by Commission.
8. Have on-duty personnel in sufficient number and with sufficient training and experience and F.A.A. rating to provide an adequate level of service to its customers.
9. Have equipment and supplies on hand to provide an adequate level of service to its customers.
10. Provide office and reception areas adequate for services offered.

11. Have available at least one (1) aircraft based at Airport which is certified and airworthy for demonstration purposes.

12. Use leased premises and provide Commercial Services in accordance with any other applicable Federal, State or local law, rule or regulation.

C. Insurance Policies. Operator shall procure and maintain, during the term of any lease or agreement the insurance policies hereinafter specified. Said policies must be issued by an insurance company or companies authorized to do business in the State of Wisconsin and licensed by the Insurance Department of the State. Operator shall furnish a Certificate of Insurance indicating compliance with the foregoing, including the naming of City as an "additional insured", and proof of payment of premium to the Airport Director for approval. The insurance policy or policies shall contain a clause that in the event that any policy issued is canceled or terminated for any reason, or any material changes are made therein, the Airport Director will be notified, in writing, by the insurer at least thirty (30) days before any cancellation, termination or change takes effect. If for any reason, the insurance coverage required herein lapses, City Common Council may declare the lease or agreement null and void as of the date no valid insurance policy was in effect. Certificates of policy renewals shall be furnished to the Airport Director throughout the term of Lease.

The following insurance coverages shall be obtained and continue in effect during the term of the lease or agreement in not less than the amounts specified:

- Worker's Compensation - Statutory - In compliance with the Worker's Compensation Law of the State of Wisconsin;
- General Liability Insurance with a minimum limit of One Million (\$1,000,000.00) Dollars per occurrence having the following coverages, where applicable:
Premises and Operations, including Hangarkeepers;
Independent Contractor and Subcontractors;
Products and Completed Operations;
Contractual; and,
Death and Personal Injury.

25.19 MINIMUM STANDARDS FOR MULTIPLE SERVICES OPERATOR

A. Definition. A **Multiple Services Operator** is a person who provide the following Commercial Aeronautical Services at Airport:

Provide two (2) or more Commercial Aeronautical Services for which minimum standards are applicable under this Ordinance (excluding a Fixed Base Operator).

B. Minimum Standards and Requirements. A Multiple Services Operator, as a condition of being permitted to operate at Airport, shall:

1. Lease a minimum of 20,000 square feet of ground space.
2. Provide a building with a minimum of 6,000 square feet of floor space for aircraft storage (repair and maintenance, if applicable), office, customer lounge and restrooms properly heated and lighted.
3. Lease aircraft parking ramp area adequate for operation, as determined by the Commission and obtain Aircraft Parking Ramp Permit.
4. Provide paved vehicle parking within the leased area adequate for operations, as determined by Commission.
5. Provide a paved walkway within the leased area to accommodate pedestrian access to the Operator's office.
6. Provide a paved aircraft apron within the leased area to accommodate aircraft movement from the Operator's land or buildings to the taxiway or to the access to the taxiway that is provided by Owner.
7. Be open for business during days and hours specified in a business plan for each Commercial

Service approved by Commission.

8. Have on-duty personnel in sufficient number and with sufficient training and experience and F.A.A. rating to provide an adequate level of service to its customers for each Commercial Service.

9. Have equipment and supplies on hand to provide an adequate level of service to its customers for each Commercial Service.

10. Provide office and reception areas adequate for services offered.

11. Have available for operation at least one (1) aircraft (owner or leased) based at Airport, which is certified and airworthy for each Commercial Service (where applicable).

12. Meet any additional minimum standards and requirements of this Ordinance for each particular Commercial Service offered.

13. Use leased premises and provide Commercial Services in accordance with any other applicable Federal, State or local law, rule or regulation.

Nothing contained herein shall be interpreted to require each Commercial Service to be provided through separate or independent facilities, equipment or personnel.

C. Insurance Policies. Operator shall procure and maintain, during the term of any lease or agreement the insurance policies hereinafter specified. Said policies must be issued by an insurance company or companies authorized to do business in the State of Wisconsin and licensed by the Insurance Department of the State. Operator shall furnish a Certificate of Insurance indicating compliance with the foregoing, including the naming of City as an "additional insured", and proof of payment of premium to the Airport Director for approval. The insurance policy or policies shall contain a clause that in the event that any policy issued is canceled or terminated for any reason, or any material changes are made therein, the Airport Director will be notified, in writing, by the insurer at least thirty (30) days before any cancellation, termination or change takes effect. If for any reason, the insurance coverage required herein lapses, City Common Council may declare the lease or agreement null and void as of the date no valid insurance policy was in effect. Certificates of policy renewals shall be furnished to the Airport Director throughout the term of Lease.

The following insurance coverages shall be obtained and continue in effect during the term of the lease or agreement in not less than the amounts specified:

- Worker's Compensation - Statutory - In compliance with the Worker's Compensation Law of the State of Wisconsin;
- General Liability Insurance with a minimum limit of One Million (\$1,000,000.00) Dollars per occurrence and One Million (\$1,000,000.00) per passenger seat, having the following coverages, where applicable:

Premises and Operations, including Hangarkeepers;

Independent Contractor and Subcontractors;

Products and Completed Operations;

Contractual; and,

Death and Personal Injury.

Where aviation fuel or other petroleum product is dispensed on leased premises, environmental liability (pollution) insurance coverage, with a minimum limit of One Million (\$1,000,000.00) Dollars, is required, including third party bodily injury and property damage protection and resulting cleanup, as a consequence of fuel spill, overfill, leak accident or other event from underground/aboveground storage tanks or fueling or petroleum dispensing trucks.

25.20 MINIMUM STANDARDS FOR T-HANGAR, COMMON HANGAR AND TIE-DOWN AIRCRAFT STORAGE OPERATOR

A. Definition. A **T-Hangar, Common Hangar and Tie-Down Aircraft Storage Operator** is a person who provides the following Commercial Aeronautical Services at Airport:

T-Hangar or Common Hangar for aircraft storage available to the general public or for private use.

CODE OF GENERAL ORDINANCES, 2021 - KENOSHA, WISCONSIN

Tie-Down storage may (where specifically authorized by Commission) be provided by the Hangar Operator within the leased area adjacent to the hangars, providing approved spacing and anchors are available. The Operator may not furnish any services which might in any way place the care, custody, and control of the aircraft of others, stored on Operator's premises, in Operator's control.

B. Minimum Standards And Requirements. A T-Hangar, Common Hangar and Tie-Down Aircraft Storage Operator, as a condition of being permitted to operate at Airport, shall:

1. Construct the T-Hangar and/or Common Hangar in accordance with design and construction standards required and established by the City for the facility involved.
2. Minimum space and area requirements are as follows:
 - a. T-Hangars shall be of a size sufficient to accommodate at least ten (10) aircraft. This requirement may be waived if a parcel of land suitable for T-Hangar development will not accommodate a full ten unit building.
 - b. Common Hangars shall have at least five thousand (5,000) square feet of floor space.
 - c. The Operator shall lease from the City a ground area adequate to meet the hangar requirements specified above.
 - d. No other commercial services may be offered under this Section.
3. The lease shall be for a term mutually agreed upon between the parties commensurate with the Operator's financial investment in his/her facility.
4. In the T-Hangars or Common Hangar buildings, the use of hazardous materials such as inflammable liquids, gases or similar materials is prohibited. The performance of doping, painting, stripping, fueling or open flame operations will offer no waste to Kenosha Regional Airport, each operator will be responsible for handling and removing same from Airport premises.
5. No major engine repairs or major airplane repairs or alterations as defined by the F.A.A. are allowed in T-Hangar areas. No work is allowed on fuel systems due to its inherent hazards.
6. No outside storage of equipment or material is permitted.
7. The Operator shall lease a ramp permit adequate to serve the hangar as determined by the Commission.
8. Use leased premises and provide Commercial Services in accordance with any other applicable Federal, State or local law, rule or regulation.

C. Insurance Policies. Operator shall procure and maintain, during the term of any lease or agreement the insurance policies hereinafter specified. Said policies must be issued by an insurance company or companies authorized to do business in the State of Wisconsin and licensed by the Insurance Department of the State. Operator shall furnish a Certificate of Insurance indicating compliance with the foregoing, including the naming of City as an "additional insured", and proof of payment of premium to the Airport Director for approval. The insurance policy or policies shall contain a clause that in the event that any policy issued is canceled or terminated for any reason, or any material changes are made therein, the Airport Director will be notified, in writing, by the insurer at least thirty (30) days before any cancellation, termination or change takes effect. If for any reason, the insurance coverage required herein lapses, City Common Council may declare the lease or agreement null and void as of the date no valid insurance policy was in effect. Certificates of policy renewals shall be furnished to the Airport Director throughout the term of Lease.

The following insurance coverages shall be obtained and continue in effect during the term of the lease or agreement in not less than the amounts specified:

- Worker's Compensation - Statutory - In compliance with the Worker's Compensation Law of the State of Wisconsin;

- General Liability Insurance with a minimum limit of One Million (\$1,000,000.00) Dollars per occurrence having the following coverages, where applicable:
Premises and Operations, including Hangarkeepers;
Independent Contractor and Subcontractors;
Products and Completed Operations;
Contractual; and,
Death and Personal Injury.

25.21 MINIMUM STANDARDS FOR FLYING CLUB OPERATOR

A. Definition. A **Flying Club Operator** is a person who provides the following Commercial Aeronautical Services at Airport:
Flying Club

B. Minimum Standards And Requirements. A Flying Club Operator, as a condition of being permitted to operate at Airport, shall:

1. The Club will operate as a nonprofit corporation.
2. Each member must be an owner of the aircraft or a stockholder in the corporation.
3. The Club may not derive greater revenue from the use of its aircraft than the amount necessary for the actual use of, operation, maintenance and replacement of its aircraft.
4. The Club's aircraft will not be used by other than bona fide members for rental and by no one for hire, charter or air taxi.
5. Club members may receive student instruction by a lessee based on the Airport who provides flight training or a member of the Club, if having an appropriate F.A.A. rating.
6. The Club will keep current a complete list of the Club's membership and annually file the list with the Airport Director.

C. Insurance Policies. Operator shall procure and maintain, during the term of any lease or agreement the insurance policies hereinafter specified. Said policies must be issued by an insurance company or companies authorized to do business in the State of Wisconsin and licensed by the Insurance Department of the State. Operator shall furnish a Certificate of Insurance indicating compliance with the foregoing, including the naming of City as an "additional insured", and proof of payment of premium to the Airport Director for approval. The insurance policy or policies shall contain a clause that in the event that any policy issued is canceled or terminated for any reason, or any material changes are made therein, the Airport Director will be notified, in writing, by the insurer at least thirty (30) days before any cancellation, termination or change takes effect. If for any reason, the insurance coverage required herein lapses, City Common Council may declare the lease or agreement null and void as of the date no valid insurance policy was in effect. Certificates of policy renewals shall be furnished to the Airport Director throughout the term of Lease.

The following insurance coverages shall be obtained and continue in effect during the term of the lease or agreement in not less than the amounts specified:

- Worker's Compensation - Statutory - In compliance with the Worker's Compensation Law of the State of Wisconsin;
- General Liability Insurance with a minimum limit of One Million (\$1,000,000.00) Dollars per occurrence having the following coverages, where applicable:
Premises and Operations, including Hangarkeepers;
Independent Contractor and Subcontractors;
Products and Completed Operations;
Contractual; and,
Death and Personal Injury.

25.22 SHORT TERM PERMITS FOR OPERATORS OF OTHER COMMERCIAL AERONAUTICAL SERVICES

A. A person desiring to provide a Commercial Aeronautical Service at Airport on a short term and not regularly occurring basis and does not meet the minimum standards specified in this Ordinance for that service may provide such services upon procuring a permit from the Airport Director for a daily fee approved by the Airport Commission under circumstances where such Operator meets all F.A.A. certifications and requirements.

B. Insurance Policies. Operator shall procure and maintain, during the term of any lease or agreement the insurance policies hereinafter specified. Said policies must be issued by an insurance company or companies authorized to do business in the State of Wisconsin and licensed by the Insurance Department of the State. Operator shall furnish a Certificate of Insurance indicating compliance with the foregoing, including the naming of City as an "additional insured", and proof of payment of premium to the Airport Director for approval. The insurance policy or policies shall contain a clause that in the event that any policy issued is canceled or terminated for any reason, or any material changes are made therein, the Airport Director will be notified, in writing, by the insurer at least thirty (30) days before any cancellation, termination or change takes effect. If for any reason, the insurance coverage required herein lapses, City Common Council may declare the lease or agreement null and void as of the date no valid insurance policy was in effect. Certificates of policy renewals shall be furnished to the Airport Director throughout the term of Lease.

The following insurance coverages shall be obtained and continue in effect during the term of the lease or agreement in not less than the amounts specified:

- Worker's Compensation - Statutory - In compliance with the Worker's Compensation Law of the State of Wisconsin;
- General Liability Insurance with a minimum limit of One Million (\$1,000,000.00) Dollars per occurrence having the following coverages, where applicable:
 - Premises and Operations, including Hangarkeepers;
 - Independent Contractor and Subcontractors;
 - Products and Completed Operations;
 - Contractual; and,
 - Death and Personal Injury.

25.23 SEVERABILITY

If any part of this Ordinance shall be held invalid, such part shall be deemed severable and the invalidity thereof shall not affect the remaining parts of this Ordinance.

25.24 PENALTIES

Any person, party, firm or corporation who shall violate any of the provisions of this Chapter shall, upon conviction thereof, forfeit not less than One Hundred (\$100.00) Dollars, nor more than Five Hundred (\$500.00) Dollars. The violator will also be responsible for the costs of prosecution, and in default of payment of forfeiture and costs of prosecution, shall be imprisoned in the County Jail until such forfeiture and costs are paid, for a period not to exceed thirty (30) days. Each day's failure to comply with any provision of this Ordinance shall constitute a separate violation.

CHAPTER XXVI
KENOSHA CABLE TELEVISION
FRANCHISE ORDINANCE

26.01 SHORT TITLE

This Chapter shall be known and may be cited as the "Kenosha Cable Television Franchise Ordinance", hereinafter "Ordinance".

26.02 DEFINITIONS AND INTERPRETATION

A. Specific Terms, Phrases and Words. For the purpose of this Ordinance the following terms, phrases, words and their derivations shall have the meaning given herein. In the event of a conflict between terms defined in this Ordinance and any subsequent Franchise Agreement, the definition in the Franchise Agreement shall control.

1. "Basic Cable Service" means the tier of Service which, at a minimum, includes all signals of domestic television broadcast stations provided to any Subscriber (except the signal secondarily transmitted by satellite carrier beyond the local Service area of such station, regardless of how such signal is ultimately received by the Cable System) any public, educational, and governmental programming required by the Franchise to be carried on the basic tier, and any additional video programming signals or services added to the basic tier by the Grantee. (Definition taken from FCC Regulations at 47 CFR, Section 76.901(a).)

2. "Cable Administrator" means the Mayor and designees of the Mayor.

3. "Cable Service" or "Service" means: **(a.)** the one-way transmission to Subscribers of **(1.)** video programming; or, **(2.)** other programming services; and, **(b.)** Subscriber interaction, if any, which is required for the selection, or use, of such video programming or other programming service. (Definition taken from FCC Regulations at 47 U.S.C. §522(6)).

4. "Cable System" means a facility, consisting of a set of closed transmission paths and associated signal generation, reception, and control equipment that is designed to provide Cable Service which includes video programming and which is provided to multiple Subscribers within the City, but such term does not include:

a. A facility that serves only to retransmit the television signals of one (1) or more television broadcast stations;

b. A facility that serves Subscribers without using any public Right-of-Ways;

c. A facility of a common carrier which is subject, in whole or in part, to the provisions of Subchapter II of 47 U.S.C. Subchapter V, except that such facility shall be considered a Cable System to the extent such facility is used in the transmission of video programming directly to Subscribers, unless the extent of such use is solely to provide interactive on-demand Services;

d. An open video system certified by the FCC; or,

e. Any facilities of any electric utility used solely for operating its electric utility system. (Definition taken from FCC Regulations at 47 U.S.C. §522(7)).

5. "Cable System Appurtenances" means any poles, structures, wire, cable, conductors, ducts, conduits, vaults, manholes, amplifiers, appliances, attachments and other fixtures which constitute the Cable System.

6. "Channel" means a portion of the electromagnetic frequency spectrum, which is used in a Cable System and which is capable of delivering a television Channel, as defined by Federal Law. (Definition taken from FCC Regulations at 47 C.F.R. §765 (4)).

7. "City" means the City of Kenosha, Wisconsin, and includes its subunits.

8. "Date of Acceptance" means the date of last execution of the Franchise Agreement following approval by the Common Council.

9. "Effective Date of Franchise" means a date specified in a Franchise Agreement which is the commencement date of the Franchise Term.

10. "FCC" means the Federal Communications Commission and any legally appointed, designated or elected agent or successor.

11. "Franchise" means a Franchise granted by City pursuant to Section 66.082, Wisconsin Statutes, for the purpose of providing Cable Service within the Franchise Area.

12. "Franchise Agreement" means a contract between City and a Grantee providing for a Franchise to provide Cable Service and operate a Cable System.

13. "Franchise Area" means the territorial limits of City on the Effective Date of Franchise and any area subsequently annexed or attached during the term of the Franchise.

14. "Grantee" means a Person to whom a Franchise under this Ordinance is granted by City Common Council, along with the lawful successors or assigns.

15. "Initial Franchise" means a Franchise to provide Cable Service to and operate a Cable System issued to a Grantee where the Grantee (or any predecessor) has not previously been granted a Franchise by the City.

16. "Institutional Network" means a dedicated network (sometimes separate, sometimes integrated with the general Subscriber network) for use by institutions such as schools, hospitals, government and nonprofit agencies, and business.]

17. "Law(s)" means laws, rules and regulations as they exist at the time of adoption of this Ordinance, and as they may exist in the future, including lawful executive and administrative orders issued pursuant thereto.

18. "May" means permissive.

19. "PEG Access" shall mean public, educational and governmental access.

20. "Person" shall mean any individual, partnership, association, corporation, legal entity or organization of any kind. "Person" shall not include a municipal corporation unless otherwise indicated.

21. "Renewal Franchise" means a Franchise obtained from City pursuant to the procedure outlined in 47 U.S.C. §546 and any other relevant local, State or Federal Laws.

22. "Right-of-Way" means the area of a Street reserved for a public travel or other public purpose, including the Street, lawn park area and sidewalk.

23. "Shall" means mandatory.

24. "Street" means the surface of and all Right-of-Ways and the space above and below any public Street, road, highway, freeway, lane, path, public way or place, sidewalk, alley, court, boulevard, parkway, drive or easement now or hereafter held by the City for the purpose of public travel, which shall, within their proper purpose and meaning, entitle the Grantee to the use thereof for the purposes of installing Cable System Appurtenances as may be necessary and pertinent to a Cable System.

25. "Subscriber" shall mean any Person (including City, County and Educational Institutions) lawfully receiving Basic Cable Service and/or any additional Cable Service from Grantee.

B. Interpretation.

1. Whenever a position title is referenced in this Ordinance, the term shall include authorized designees.

2. Whenever a position title is referenced in this Ordinance, and the position or title is abolished, consolidated or changed, the successor shall have authority to act under this Ordinance and the Franchise.

3. Whenever a governmental body or subunit is referenced in this Ordinance, and the body or subunit is abolished, consolidated or changed, the successor body shall have authority to act under this Ordinance and the Franchise.

4. Whenever a definition has its basis in Federal or State Law, and such definition is changed, the change shall be incorporated in this Ordinance by reference.

26.03 FRANCHISE REQUIRED FOR CABLE SYSTEM/SERVICE

No Person shall operate a Cable System or provide Cable Service within City or use the Streets of City for Cable System construction, installation, operation and maintenance purposes, without first obtaining a Franchise from City Common Council and entering into a Franchise Agreement as provided for under this Ordinance.

26.04 FRANCHISE AWARD

Upon award of any Franchise by City Common Council and execution of a Franchise Agreement, Grantee shall be bound, for the Franchise Term by all terms and conditions of this Ordinance and the Franchise Agreement, and shall provide Cable Services and operate a Cable System and perform related undertakings of any nature specifically set forth in the Franchise Agreement, within the geographical limits of the Franchise Area. The Franchise Agreement may incorporate therein by reference all or part of any proposal of Grantee and this Ordinance.

26.05 RIGHT AND PRIVILEGE OF GRANTEE IN STREETS

Any Franchise awarded by City Common Council pursuant to Section 66.082, Wisconsin Statutes, and this Ordinance, shall be for the sole purpose of providing Cable Service and operating a Cable System. A Grantee awarded a Franchise, upon execution of a Franchise Agreement, and in accordance with procedures established therein, shall have the right and privilege to erect, construct, operate and maintain in, upon, and along, across, above, over and under any Streets, within the Franchise Area, any Cable System Appurtenances necessary or useful for the operation and maintenance of a Cable System and provision of Cable Service.

26.06 FRANCHISE APPLICABILITY AND ADMINISTRATION

A Franchise is applicable to the Franchise Area in accordance with the terms and conditions of a Franchise Agreement. Cable Administrator shall, except where another Person or body is designated, administer the Franchise on behalf of City.

26.07 FRANCHISE AGREEMENT AND TERM OF FRANCHISE

The Franchise and the rights, privileges and authority granted thereunder shall take effect on the Effective Date of Franchise Agreement and be in force and effect as set forth in a duly and properly executed Franchise Agreement, and shall continue in force and effect for a term specified in the Franchise Agreement, but for a term of no longer than twenty (20) years. The Franchise Agreement shall be in writing and duly executed by authorized officers of City and Grantee sworn to before a Notary Public or other officer authorized by Wisconsin Law to administer oaths.

26.08 INITIAL FRANCHISE

A. Request For Proposals. Cable Administrator may develop a written request for proposals for an Initial Franchise which shall include a procedure for submission and review. Any Person seeking an Initial Franchise shall submit a sealed proposal at the time and place indicated in the request for proposals for a public opening. Proposals may be modified through additional submissions at any time prior to the opening, provided that any modifications must be duly executed in the same manner as the original proposal. No proposal shall be opened or inspected before the public opening. All proposals received by

City for an Initial Franchise are the sole property of City and may not be withdrawn. City reserves the right to extend the time for receiving proposals.

B. City Rights. City reserves the right to reject any and all proposals and waive informalities and/or technicalities in any proposal or in the proposal process.

C. Interpretation. Questions regarding the meaning or intent of this Ordinance or the request for proposals may be submitted to Cable Administrator in writing. Replies will be mailed or delivered to all parties recorded by City as having received proposals. Questions received less than fourteen (14) days prior to the date for the opening of proposals may not be answered. Only timely, written replies to questions will be binding on City. Proposers must acknowledge receipt of all written responses to questions.

D. Before submitting a proposal, each proposer must:

1. Thoroughly examine this Ordinance and the request for proposals;
2. Familiarize themselves with local conditions that may in any manner affect performance under the Franchise;
3. Familiarize themselves with Federal, State and local Laws affecting performance under the Franchise; and,
4. Carefully prepare the proposal to meet the requirements of this Ordinance and the request for proposals.

E. City Review. City may make such investigations as it deems necessary to determine the ability of the proposer to perform under the Franchise, and the proposer shall furnish to City all such information and data for this purpose as City may request. City reserves the right to reject any proposal if the information and data submitted by proposer, or investigation of City, reveals that such proposer is not properly qualified to carry out the obligations of the Franchise and to complete the work contemplated therein in a timely manner. Conditional proposals will not be accepted.

F. Franchise Awards. An Initial Franchise shall be awarded by the Common Council of City following review by such subunits and professional consultants as City deems appropriate.

26.09 FRANCHISE RENEWAL PROCESS

The Franchise renewal process shall be held in accordance with applicable Federal Law. Should the Federal renewal process be eliminated or significantly modified, City Common Council reserves all rights to determine the Franchise renewal process to the extent it is not controlled by Federal or State Law.

26.10 POLICE POWERS

A. General and Zoning Ordinances. The rights conferred upon a Grantee through a Franchise shall be subject to the police power of City to adopt and enforce such General and Zoning Ordinances as are necessary to protect the public health, safety and welfare; and Grantee shall comply with all applicable General and Zoning Ordinances enacted by City, from time to time during the Franchise.

B. New Cable Regulations. The right and power is hereby reserved by City to amend this Ordinance, from time to time during the term of the Franchise, to promulgate such additional regulations of a Franchise as it shall find necessary in the exercise of its lawful powers; provided such amendments and additional regulations are not in conflict with the provisions of the Franchise Agreement or Federal or State Law.

26.11 USE OF GRANTEE FACILITIES BY CITY

The Franchise Agreement may set forth procedures by which City may use the facilities of Grantee.

26.12 COSTS OF AWARDING FRANCHISE

Grantee shall bear all costs and expenses of City awarding the Initial Franchise, and reimburse City therefore within thirty (30) days of the Date of Acceptance of the Franchise. The payments made pursuant to this Section shall not be deemed to be "Franchise Fees" within the meaning of Section 622 of the Cable Act (47 U.S.C. Section 542) and such payments shall not be deemed to be: (1) "payments-in-kind" or involuntary payments chargeable against compensation to be paid to City by Grantee; or, (2) "external costs" under the regulations of the FCC.

26.13 NOTICES UNDER FRANCHISE AGREEMENT

A Franchise Agreement shall set forth the procedures for all notices from Grantee to City or from the Grantee to the City.

26.14 IRREVOCABLE LETTER OF CREDIT/CASH SECURITY DEPOSIT

A Franchise Agreement shall require a Performance Bond, Irrevocable Letter of Credit or cash security deposit to be used to insure the faithful performance of Grantee of all provisions of the Franchise Agreement and this Ordinance, and compliance with all orders, permits and directions of any subunit, department, or office of City having jurisdiction over the Franchise.

The rights reserved to City with respect to the Irrevocable Letter of Credit or cash security deposit are in addition to all other rights of City, whether authorized by this Ordinance, the Franchise Agreement or otherwise authorized by Law or equity, and no action, proceeding or exercise of a right with respect to such Irrevocable Letter of Credit or cash security deposit shall affect or waive any other legal or equitable right City may have.

26.15 CONSTRUCTION ASSURANCE

Within thirty (30) days after the Date of Acceptance of the Franchise requiring construction, reconstruction or improvement of a Cable System, Grantee shall file with City a Construction Assurance in a form approved by the City Attorney and in the amount determined by the Franchise Agreement. This assurance shall be maintained throughout the construction period and for such additional time as may be determined by the Franchise Agreement.

If Grantee fails to well and truly observe, fulfill and perform each term and condition of the Franchise, as it relates to the conditions relative to the construction, reconstruction or improvement of the Cable System, there shall be recoverable any damages or loss suffered by City as a result thereof, including the full amount of any compensation, indemnification, or cost of removal of any abandoned property of Grantee, plus a reasonable allowance for attorneys' fees, including City's legal staff, and other enforcement costs. This provision shall not be limited by any other remedy provided for in this Ordinance or the Franchise Agreement.

26.16 LIABILITY INSURANCE REQUIRED

A Franchise Agreement shall require that a Grantee maintain throughout the term of the Franchise, general and automobile liability insurance insuring Grantee, with City being an additional insured, in such minimum amounts as may be required in the Franchise Agreement.

Certificates of Insurance shall be obtained by the Grantee annually during the term of the Franchise, indicating uninterrupted compliance with this Section, and filed with the City Clerk/Treasurer.

The provisions of this Section shall not be construed as to limit the liability of the Grantee under any Franchise issued hereunder.

The insurance policies required herein shall be issued by insurance companies licensed to do business within the State of Wisconsin, and provide thirty (30) days advance, written notice of any cancellation, termination or modification to both the City Clerk/Treasurer and Grantee. Grantee shall, in the event of any such notice, obtain, pay all premiums for, and file with the City Clerk/Treasurer a Certificate of Insurance as evidence of the issuance of replacement insurance policies within the notice period so as to provide for uninterrupted insurance coverage.

26.17 INDEMNITY AND HOLD HARMLESS

A. A Franchise Agreement shall contain provisions requiring that a Grantee shall, at its sole cost and expense, indemnify and hold harmless City, its subunits, the Kenosha Community Television Commission and their officers and employees (hereinafter "Indemnities").

B. Nonwaiver of Statutory Limits. Nothing contained in this Ordinance is intended to express or imply a waiver of the statutory notice and claim provisions or liability limits, of any kind or nature, as set forth in Federal or State Law.

26.18 DISCLAIMER OF LIABILITY

City, in awarding a Franchise under this Ordinance, does not assume any liability for injury or damage occurring to any Person or property from any cause whatsoever arising out of the construction, installation, improvement, maintenance, repair, use, operation, condition or dismantling of Grantee's Cable System or due to the act or omission of any Person other than those Persons for which City is liable as a matter of Law.

26.19 COMPLIANCE WITH LAW

A. General. Grantee, in constructing, installing, improving, maintaining, repairing, using, operating or dismantling a Cable System and providing Cable Service under this Ordinance and the Franchise Agreement, shall comply with all applicable Federal, State and local Laws.

B. Nondiscrimination. Grantee, in providing Cable Service and operating a Cable System, under this Ordinance and the Franchise Agreement, shall not discriminate against any Person based upon a classification protected by Federal, State or local Law.

C. Privacy. Grantee, in providing Cable Service and operating a Cable System, shall comply with any privacy requirements imposed by Federal, State or local Law and the Franchise Agreement.

D. Notice and Resolution of Conflict. Should any Federal, State or local Law requiring Grantee to perform any Service, or permitting Grantee to perform any Service, or prohibiting Grantee from performing any Service, be in conflict with the terms of the Franchise Agreement or should there be a conflict in any such Laws, then as soon as possible following knowledge thereof, Grantee and/or City shall notify the other of the conflict believed to exist.

Should City or Grantee determine that any such conflict exists, City and Grantee shall negotiate in

good faith to modify any such provisions to the extent necessary to carry out the full intent and purpose of this Ordinance and the Franchise Agreement.

26.20 CABLE SERVICE AVAILABILITY

Grantee shall make available and provide Cable Service throughout the Franchise Area, as required by the Franchise Agreement. No Person shall arbitrarily be denied Cable Service.

26.21 CABLE SYSTEM CONSTRUCTION AND EXTENSION POLICY

A. Initial Franchise and Renewal Franchise Cable System Construction Timetable. Grantee shall construct a Cable System for an Initial Franchise and Renewal Franchise within the Franchise Area in accordance with a schedule determined in a Franchise Agreement.

B. Cable System Extensions To Newly Developing Areas. Grantee shall extend its Cable System to newly developing and unserved areas of the Franchise Area pursuant to provisions set forth in a Franchise Agreement.

C. Franchise Agreement Provisions. The Franchise Agreement may provide for Cable System construction, installation, and extension which exceeds those standards set forth in this Ordinance.

26.22 CONSTRUCTION AND TECHNICAL PERFORMANCE STANDARDS

A. Construction and Technical Performance Standards. Grantee shall construct, improve, install, operate and maintain its Cable System in a manner consistent with all applicable Federal, State and local construction and technical performance standards as more fully set forth in a Franchise Agreement.

B. Cable System Construction, Improvement, Installation and Maintenance. Construction, improvement, installation and maintenance of the Cable System shall be performed in accordance with the Franchise Agreement.

C. Cable System Design. Cable System initial design, upgrade, functionality, and Channel capacity shall meet the minimum specifications, requirements, and standards set forth in a Franchise Agreement. Nothing contained herein shall prohibit City from increasing these minimum specifications, requirements and standards through a request for proposal process or Franchise Agreement negotiation or renegotiation process. This provision does not waive any right or obligations of City or a Grantee under 47 U.S.C. §546.

D. Programming. A Grantee shall include in its Cable Service a broad range of programming.

26.23 USE OF STREETS

Grantee shall use City Streets, where required, for its Cable System, in accordance with the terms and conditions for such usage as are set forth in the Franchise Agreement.

26.24 OPERATIONAL STANDARDS

A Franchise Agreement shall set forth the operational standards, including minimum customer service standards, to be met by a Grantee.

26.25 CONTINUITY OF CABLE SERVICE

A. Subscribers' Right. It shall be the right of all Subscribers to receive continuous and uninterrupted Cable Service where their financial and other obligations to Grantee are met. If Grantee elects to overbuild, rebuild, modify or sell the Cable System, or City gives notice of intent to terminate the Franchise or fails to renew the Franchise, Grantee shall act so as to ensure that all Subscribers receive continuous, uninterrupted Cable Service regardless of the circumstances.

B. Transfer of Franchise Ownership or Control. If there is a change of Franchise ownership or control, Grantee shall cooperate with City, and new Grantee or operator in maintaining continuous and uninterrupted Cable Service to all Subscribers.

C. Failure To Provide Continuous Service. Should Grantee fail to operate the Cable System for seven (7) consecutive days without prior approval of Cable Administrator or without just cause, City may, at its option, operate the Cable System or designate an operator until such time as Grantee restores Cable Service under conditions acceptable to City. Should City be required to fulfill this obligation for Grantee, then Grantee shall reimburse City for all reasonable costs, expenses in excess of revenues from the operation of the Cable System received by City, and damages that are the result of Grantee's failure to perform.

26.26 CABLE SERVICE COMPLAINT PROCEDURE

A Franchise Agreement shall set forth provisions to enable the City to monitor the performance of a Grantee, including a provision allowing the City to have tests conducted of the Cable System.

26.27 GRANTEE RULES AND REGULATIONS

Grantee shall have the authority to promulgate such written rules and regulations governing the conduct of its business as shall be reasonably necessary to enable Grantee to exercise its rights and perform its obligations under the Franchise, and to assure continuous and uninterrupted Cable Service to its Subscribers; provided, however, that such rules and regulations shall not be in conflict with this Ordinance or the Franchise Agreement.

26.28 FRANCHISE FEE AND PEG ACCESS CHARGES AND COSTS

A Franchise Agreement shall set forth the Franchise Fee and PEG Access charge obligations of the Grantee include the time and manner of payment, the City's right to audit the Grantee's records to insure proper payment, interest payable to the City in the event of late payment by the Grantee and the City's rights in the event of a termination of the Franchise Agreement.

26.29 TRANSFER OF OWNERSHIP OR CONTROL

The procedures for transfers and assignments of the Franchise, including a change of control in the Grantee, will conform to the requirements as set forth in Federal Law, and the Franchise Agreement.

26.30 BOOKS, RECORDS AND REPORTS OF GRANTEE

A Franchise Agreement shall specify the City's right to inspect the books and records of the Grantee and describe such reports as may be required of the Grantee.

26.31 CITY PROGRAMMING, SERVICE TO SCHOOLS AND GOVERNMENT BUILDINGS, AND PEG ACCESS

- A.** City Programming. Nothing contained in this Ordinance or the Franchise Agreement shall prohibit City from producing, directing or televising programs or messages of a public service nature.
- B.** Service To Schools And Government Buildings. Grantee shall provide Service to schools and government buildings as specified in a Franchise Agreement.
- C.** Institutional Network (I- Net) Service To Schools. Grantee shall provide an Institutional Network (I-Net) as may be specified in a Franchise Agreement.
- D.** EG Access. Grantee shall provide PEG Access as specified in a Franchise Agreement.
- E.** PEG Access Facilities. Grantee shall provide PEG Access Facilities specified in a Franchise Agreement.

26.32 PERFORMANCE EVALUATION SESSIONS

The Franchise Agreement shall set forth any performance evaluation sessions (including procedures for notices of the evaluation sessions and topics to be discussed) that may be required of the Grantee.

26.33 RATE CHANGE PROCEDURES

A Franchise Agreement shall set forth the procedures for rate changes by the Grantee.

26.34 FINANCIAL, CONTRACTUAL, SHAREHOLDER AND SYSTEM DISCLOSURE

A. General Disclosure. No Initial Franchise will be granted to any proposer unless all requirements and demands of City regarding financial, contractual, shareholder and System disclosure have been met.

Proposers, including all shareholders and parties with any interest in the proposer, shall fully disclose to City all agreements and undertakings, whether written or oral, or implied with any Person respecting the Franchise and the proposed Cable System. Proposer shall also disclose any other contracts with City. This Section shall be interpreted to include, but not be limited to, any agreements between local applicants and national companies.

Proposers, including all shareholders and parties with any interest in the proposer, shall submit all requested information to City as provided by the terms of this Ordinance or the proposal documents, or otherwise requested. The requested information must be complete and verified as true by the proposer.

Proposers, including all shareholders and parties with any interest in the proposer, shall disclose to City the numbers of shares of stock, and the holders thereof, and shall include the amount of consideration for each share of stock and the nature of the consideration.

B. Disclosure of Other Cable Systems. Proposers, including all shareholders and Persons with any interest in the proposer, shall disclose to City any information required by the request for proposal documents or otherwise requested by City regarding other Cable Systems in which they hold an interest of any nature, including, but not limited to, the following:

1. Locations of all other Franchises and the dates of award for each location;
2. Estimated dates of other Franchise awards;
3. Estimated number of miles and number of miles completed in each Cable System as of the date of the proposal; and,
4. Date for completion of construction as promised in the application for each Cable System.

C. Disclosure of Other Cable System Applications. Proposals, including all shareholders and Persons with any interest in the proposer, shall disclose to City any information required by the request for proposal documents or otherwise requested by City regarding pending applications for other Cable Systems, including, but not limited to, the following:

1. Location of other Franchise applications and date of application for each Cable System;
2. Estimated dates of other Franchise awards;
3. Estimated number of miles of construction relevant to other Franchise sought; and,
4. Estimated construction costs of other Franchise sought.

26.35 FORECLOSURE AND RECEIVERSHIP

The Franchise Agreement shall specify procedures in the event of a foreclosure or receivership.

26.36 RIGHT OF ACQUISITION BY THE CITY

A Franchise Agreement shall specify the rights of the City to acquire the Cable System.

26.37 TERMINATION OF FRANCHISE FOR SUBSTANTIAL BREACH

A. Termination of Franchise. A Franchise Agreement shall provide that in addition to all other rights and powers retained by City under this Ordinance, a Franchise Agreement, or otherwise under existing Law, the City reserves the right to terminate the Franchise. The Franchise Agreement shall set forth the grounds upon which a Franchise may be terminated and the procedures for any such termination.

B. Affect of Termination. Upon termination of a Franchise, whether by action of City as provided above, or expiration and nonrenewal of the Franchise, Grantee shall be obligated to cease using the Cable System for the purposes authorized by the Franchise.

C. Remedies Cumulative. All remedies under this Ordinance, and any Franchise Agreement, are cumulative unless otherwise expressly stated. The exercise of one remedy shall not foreclose use of another, nor shall the exercise of a remedy or the payment of liquidated damages or penalties relieve a Grantee of its obligations to comply with this Ordinance or the Franchise Agreement. Remedies may be used singly or in combination. In addition, City may exercise any rights it has at Law or equity. Recovery by City of any amounts under insurance, the Performance Bond, the security fund, or the Irrevocable Letter of Credit, or otherwise, does not limit Grantee's duty to indemnify City in any way; nor shall such recovery relieve a Grantee of its obligations under a Franchise, limit the amounts owed to City, or in any respect prevent City from exercising any other right or remedy it may have. Nothing herein shall be read to authorize the double recovery of damages.

D. Right to Require Dismantling. In the event that City exercises its option to require Grantee to dismantle the Cable System, Grantee shall, in an expeditious manner, at its own cost and expense, and at the discretion of City, restore any property, public or private, to the condition in which it existed prior to the erection or construction of the Cable System, including any improvements made by any Person to such property subsequent to the construction of the Cable System.

26.38 REMOVAL OF CABLE SYSTEM INFRASTRUCTURE

At the expiration (and denial of renewal and exhaustion of all appeals) or termination of the Franchise, Grantee shall forthwith, upon request by Cable Administrator, remove at its own cost and expense, all designated portions of the Cable System from all Streets and public property within the City. If Grantee fails to do so, City may perform the work at Grantee's cost and expense.

26.39 THEFT OF CABLE SERVICE

Section 943.46, Wisconsin Statutes, entitled "Theft of Cable Television Service", is incorporated into this Ordinance by reference and made a part hereof as if fully set forth herein, and as otherwise incorporated under Section 11.052 of the Code of General Ordinances for the City of Kenosha.

26.40 LIQUIDATED DAMAGES

A Franchise Agreement shall set forth a schedule of liquidated damages in the event of a breach by the Grantee and the procedure to be followed by the City in the event liquidated damages are to be collected.

26.41 PENALTIES

Any Person who operates a Cable System or provides Cable Service or installs Cable System Appurtenances without a Franchise shall be in violation of this Ordinance, and shall upon conviction pay a forfeiture not to exceed One Thousand (\$1,000.00) Dollars, together with the costs of prosecution, and in default of such payment shall be committed to the County Jail for a period not to exceed ninety (90) days. Each day of violation shall be a separate offense.

CHAPTER XXVII
PUBLIC RECORDS AND PROPERTY

27.01 DECLARATION OF POLICY AND INTENT

It is the intent of the City of Kenosha Common Council to enact legislation in compliance with §§19.31 through 19.39 of the Wisconsin Statutes, or any amendments thereto. In recognition of the fact that a representative government is dependent upon an informed electorate, it is declared to be the public policy of the City of Kenosha that all persons are entitled to the greatest possible information regarding the affairs of government and the official acts of those officers and employees who represent them. Further, providing persons with such information is declared to be an essential function of our representative government and an integral part of the routine duties of officers and employees whose responsibility it is to provide such information.

27.02 CONSTRUCTION

This Chapter shall be construed in every instance with a presumption of complete public access to governmental records consistent with the conduct of governmental business. The custodian may deny a request for records where the harm to the public interest resulting from disclosure outweighs the public interest in full access to the requested record.

27.03 SCOPE

This Chapter covers all records as hereinafter defined, including those made prior to the existence of this Ordinance and still available to the general public. This Chapter relates to all internal memoranda which may not be otherwise excepted by law as well as to all materials and records as hereinafter defined which may have originated from sources other than the City of Kenosha or its officers or employees and which may not otherwise be excepted by law from disclosure.

27.04 DESTRUCTION OF RECORDS

Destruction of public records shall be accomplished only in accordance with procedures authorized by State Statutes.

27.05 DEFINITIONS

A. Authority. Authority means any of the following having custody of a record: a City office, elected or appointed officials, agency, board, commission, committee, council, department or public body corporation and politic, created by law or Ordinance, rule or order of the City of Kenosha; any quasi-governmental corporation; any court of law; the Common Council; a nonprofit corporation which receives more than fifty (50%) percent of its funds from the City and which provides services related to the public health or safety to the City; or a formally constituted subunit of any of the foregoing.

B. Confidential-Exempt Records. A record is deemed confidential and exempt from disclosure if it falls within the scope of any matter which may properly be discussed in a closed session of any public meeting pursuant to the provisions of §19.85 of the Wisconsin Statutes or has been deemed confidential pursuant to State or Federal law, rule or regulation or has been deemed confidential pursuant to a court order. Records are also confidential and exempt from disclosure where obtained under a pledge of confidentiality which was necessary and given in order to obtain the information contained therein.

C. Legal Custodian. Legal custodian is that person vested by an authority with the full legal power to render decisions and carry out the duties of the authority under this Chapter. No legal custodian shall be responsible for the records of another legal custodian unless he or she has possession of the records of such other custodian. All of the following persons are vested with the full legal power to render decisions and carry out the duties of the authority under this Chapter:

1. In an elective office, the elected official is the legal custodian of his or her records and the records of his or her office unless said elected official has designated an employee of his or her staff to

act as the legal custodian.

2. In the case of a committee of elected officials the chairperson is the legal custodian of the records of the committee.

3. In the case of a joint committee of elected officials, the co-chairpersons are the legal custodians of the records of the joint committee.

4. In the case of a board or commission, the chairperson or president of the board or commission shall be the legal custodian of the records of the board or commission.

5. In the case of an agency or department or of a nonprofit corporation receiving more than fifty (50%) percent of its funds from the City and which provides services related to the public health or safety to the City, the agency or department head or highest ranking officer and chief administrative officer shall be the legal custodian of the records of the agency, department or nonprofit corporation.

D. Personal Material. Personal material is any record or part thereof which contains only those communications which are totally unrelated to the affairs of government.

E. Record. Record means any material on which written, drawn, printed, spoken, visual or electromagnetic information is recorded or preserved, regardless of physical form or characteristics, which has been created or is being kept by an authority. Record includes, but is not limited to, handwritten, typed or printed pages, maps, charts, photographs, films, recordings, tapes (including computer tapes), and computer printouts. Record does not include drafts, notes, preliminary computations and like materials prepared for the originator's personal use or prepared by the originator in the name of a person for whom the originator is working; materials which are purely the personal property of the custodian and have no relation to his or her office; materials to which access is limited by copyright, patent or request; and published materials in the possession of an authority other than a public library which are available for sale or which are available for inspection at a public library.

F. Requester. Requester means any person who requests inspection or copies of a record.

G. Search. Search means any activity involving the locating of a record undertaken on behalf of a requester.

H. Sufficient Request. A request is deemed sufficient if it reasonably describes the requested record or the information requested. However, a request for a record without a reasonable limitation as to subject matter or length of time represented by the record does not constitute a sufficient request.

I. Timely Access. Timely Access to records means access to records for purposes of inspection or copying as soon as practicable after the request has been made, taking into consideration the other responsibilities and duties of the legal custodian, personnel limitations, and the nature and quantity of the request. Where access cannot be granted within five (5) business days of the request, the requester shall be so informed in writing along with the date by which the information shall be provided, the reason for the delay, and the requester's right to appeal the delay.

27.06 DEPUTY AND ALTERNATE CUSTODIANS OF PUBLIC RECORDS

A. Deputy Custodians. All legal custodians, with the exception of members of the Common Council, shall designate one or more deputy legal custodians who shall act in the absence of the legal custodian.

B. Alternate Custodians. City Committees, Boards, Authorities and Commissions herein enumerated, due to lack of a permanent office and staff, shall, except when they are determined to be their own exclusive custodian, have alternate custodians who shall be such City Department Heads as hereinafter specified. Where applicable, the deputy custodians of a Department Head shall also be the deputy custodians for the designating City Committee, Board, Authority or Commission. The alternate custodians shall be as follows:

FINANCE COMMITTEE - City Clerk;
PUBLIC WORKS COMMITTEE - Director of Public Works
PUBLIC SAFETY & WELFARE COMMITTEE - City Clerk;
AIRPORT COMMISSION - Airport Director;
CITY PLAN COMMISSION - Director of City Development;
CIVIL SERVICE COMMISSION - Director of Human Resources;
BOARD OF HARBOR COMMISSIONERS - Director of Public Works;
BOARD OF HOUSING APPEALS - Director of City Inspections;
BOARD OF WATER COMMISSIONERS - General Manager, Water Utility;
HOUSING AUTHORITY - Executive Director of Housing Authority;
LANDMARKS COMMISSION - Director of City Development;
LEGISLATIVE COMMITTEE - City Administrator;
LIBRARY BOARD - Library Director;
MUSEUM BOARD - Museum Director;
PARK COMMISSION - Director of Public Works;
BOARD OF POLICE & FIRE COMMISSIONERS - Chief of Police;
REDEVELOPMENT AUTHORITY - Director of City Development;
TRANSIT COMMISSION - Director of Transportation;
BOARD OF ZONING APPEALS - Director of City Development;
BOARD OF CANVASSERS - City Clerk.

27.07 RESPONSIBILITY OF CUSTODIAN

A. Access. It is the responsibility of the custodian to insure timely complete and full access of all records in accordance with this Chapter and Wisconsin Statutes §§19.31 to 19.39. To this end the custodian shall insure that all records as heretofore defined are properly managed, indexed and filed so as to provide for access in accordance with §§19.31 through 19.39 of the Wisconsin Statutes. If, however, a record of an authority is occasionally taken to a location other than the location where such records are regularly kept, such records may be inspected at such place as they are regularly kept upon one business day's notice. Access need not be provided at the occasional location. In the event access is denied, the legal custodian shall notify the requester of the denial in whole or in part, the reasons therefore, and the right of the requester to appeal.

B. Security. The custodian of public records shall be responsible for establishing a security system to insure the preservation of such records. The custodian shall establish such rules and regulations as deemed necessary and appropriate and not inconsistent with State Statutes to insure that such documents and records in his possession remain in his possession and unaltered or damaged.

C. Editing. The custodian is responsible for editing all such records to insure that no part of the record which is properly confidential is made public.

D. Request for Records Scheduled for Destruction. Records may not be destroyed at any time after the receipt of request for inspection or copying until after the request is granted or until at least sixty (60) days after the date that the request is denied. If an action is commenced under §19.37 of the Wisconsin Statutes, the requested record may not be destroyed until after the order of the Court in relation to such record is issued and the deadline for appealing that order is past, or, if appealed, until after the order of the Court hearing the appeal is issued. If the Court orders the production of any record, and the order is not appealed, the requested record may not be destroyed until after the request for inspection or copying is granted.

27.08 NOTICE AND FORM

Each legal custodian, as defined herein, with the exception of the members of the Common Council, shall permanently display and make available for inspection and copying at its office for the guidance of the public, a notice which, so far as relevant, follows the below provided format. The City Clerk shall provide this notice to requesters on behalf of any Board, Commission or Committee which does not maintain an office.

**WISCONSIN PUBLIC
RECORDS LAW**

(Name of Department, Committee,
Commission, Etc.)

1. Under Wisconsin Statutes, §19.35(1), a copy of which may be obtained from the legal custodian, members of the public have certain rights to access to public records. These rights include the right to inspect any record as defined herein, to photocopy said record or obtain a legible or audible copy of any tape or video recording and the right to photograph a record, the form of which does not permit copying. A member of the public need not identify himself or herself or state the purpose of the request in order to inspect or copy a record. A requester may, however, be required to show acceptable identification whenever the requested record is kept at a private residence or whenever security reasons or federal law or regulations so require. Upon access to or use of information, a requester shall comply with any regulations or restrictions which are specifically prescribed by law. In the process of honoring a request for records, the authority will not create a new record by extracting information from existing records and will not compile the information in a new format.

2. **Exceptions.** The public's right to access to public records may be limited according to law in certain circumstances where the material is deemed confidential or where the material is not a public record. In addition, the public's right to access is limited pursuant to the provision of §19.36 of the Wisconsin Statutes, a copy of which law may be obtained from the legal custodian, which permits withholding information in certain circumstances relating to the application of other laws, law enforcement records, contractor's records, computer programs and data, and trade secrets.

The provisions of the Wisconsin Public Records Law do not apply to a record which has been or will be promptly published with copies offered for sale or distribution. In addition, the City is not required to create a new record by means of extracting information from existing records and compiling the information in a new format.

3. The undersigned legal custodian is responsible for insurance compliance with §§19.31 through 19.39 of the Wisconsin Statutes and with this Chapter so as to insure that the public may obtain information and access to records in his or her custody for purposes of inspection or copying. The legal custodian may make such reasonable rules not inconsistent with State Statutes as deemed necessary to insure that records are not stolen, misplaced or damaged. The legal custodian for this office has established the following rules: (e.g., specificity, public handling, use, time requirements, cost estimates, prepayment, removal, excess costs, nonpayment on account, and reasonable limitations as to subject matter or length of time represented by the record):

CODE OF GENERAL ORDINANCES, 2021 - KENOSHA, WISCONSIN

4. The legal custodian for this office is _____; and in the event of the absence of the legal custodian, the deputy legal custodian(s) (is/ are) _____,

_____.

5. Records for the above listed authority may be obtained in the following location:

_____.

6. Records may be obtained during working days, which are normally Monday through Friday, between the hours of 8:00 A.M. and 4:30 P.M., unless otherwise specifically authorized by law.

7. Because the above listed authority does not maintain regular office hours at the location where records are kept, access is permitted to records:

a. Upon at least forty-eight (48) hours written or oral notice of intent to inspect or copy a record.

b. During the following two (2) consecutive hours on the following day of each week:

_____. Twenty-four hours advance written or oral notice to inspect or copy a record is required.

8. **Facilities.** Some facilities which are available to the employees of the above listed authority will be made available to the public to obtain information and access and to make requests for records or obtaining copies of records, inspecting such records and abstracting of records. The above listed authority is not required to purchase or lease photocopying, duplicating, photographic, video, sound duplicating or other equipment or to provide a separate room for such inspection or copying of records.

9. **Fee Schedule.** Twenty-five (\$.25) cents per page may be collected by the legal custodian to cover the copying of records. Where copies of photographs, audio or video tapes or other records not on standard sizes of paper and subject to photocopying upon existing equipment, the costs therefor shall be the actual, direct and necessary expense of the copying thereof. In the event it is necessary to search for a record, the following costs are hereby imposed: The hourly wage rate, plus fringe benefits, of the employee performing a record search where said cost equals or exceeds Fifty (\$50) Dollars.

10. **Denials and Appeals.** In the event that you are denied access to records, in whole or in part, you are entitled to know the reason for the denial. If a request is made orally, the decision to deny access may be made orally unless a demand for the written statement of the reasons for the denial is made within five (5) business days of the oral denial.

Every written denial of a request by a custodian shall inform the person making the request that if the request for the record was made in writing, then the requester may bring an action for a writ of mandamus under §19.37(1) of the Wisconsin Statutes asking a Court to order the release of the record and/or the requester may request the Kenosha County District Attorney or the Wisconsin Attorney General to bring an action for a writ of mandamus asking a Court to order release of the record to the requester.

You may seek advice from the Wisconsin Attorney General as to the applicability of the Wisconsin Public Records Law under any circumstances. The Attorney General may be contacted at the State Capitol, Madison, Wisconsin 53702.

Costs, fees and damages may be awarded where there is a violation of the Public Records and Property Law in accordance with Wisconsin Statutes §19.37(2), (3) and (4).

11. **Stolen, Concealed, Misplaced, Damaged or Altered Records.** In the event that any record inspected or copied is taken without permission, intentionally concealed, damaged or improperly altered by a member of the public, he or she may be guilty of a Class D Felony pursuant to Wisconsin Statutes §946.72(1). In the event that a member of the public negligently misplaces or damages such record, he or she may be held liable for all consequent damages including costs of replacement.

Legal Custodian

Deputy Legal Custodian

27.085 CONFIDENTIALITY OF INCOME AND EXPENSE INFORMATION

Whenever the Assessor, in the performance of his/her duties, requests and obtains income and expense information pursuant to Section 70.47(7)(af), Wisconsin Statutes, or any successor statute thereto, then, such income and expense information that is provided to the Assessor shall be held by the Assessor on a confidential basis; except, however, that said information may be revealed to and used by persons in the discharge of the duties imposed by law; in the discharge of duties imposed by office, including, but not limited to, use by the Assessor in performance of official duties of the Assessor's Office and used by the Board of Review in performance of its official duties; or pursuant to an order of a court. Income and expense information provided to the Assessor under Section 70.47(7)(af), Wisconsin Statutes, unless a court determines that it is inaccurate, is, per Section 70.47(7)(af), Wisconsin Statutes, not subject to the right of inspection and copying under Section 19.35(1), Wisconsin Statutes.

27.09 ENFORCEMENT

Enforcement of this Ordinance and costs, fees damages and penalties awarded in conjunction with enforcement of this Ordinance shall be limited exclusively to those provisions made in Wisconsin Statutes §19.37(1) to (4).

27.10 AMENDMENTS AND REPEAL

Amendments to §§19.31 through 19.39 of the Wisconsin Statutes shall be incorporated by reference as of the time that such amendment to said State Statutes take effect.

27.11 SEVERABILITY

If any provision of this Chapter is invalid or unconstitutional, or in conflict with the Wisconsin Statutes, said provision shall not affect the provisions or application of this Chapter which can be given effect without the invalid or unconstitutional provision.

CHAPTER XXVIII
VACANT BUILDING CODE

28.01 TITLE

This Chapter of the Code of General Ordinances shall be known as the "Vacant Building Code".

28.02 PURPOSE

A. This Code is enacted to facilitate the identification, inspection of, and to assure the property maintenance of vacant buildings for the purpose of preserving and promoting the public health, safety, prosperity and general welfare, and to abate and prevent public and private nuisances and potential fire hazards.

B. The Common Council of the City of Kenosha, Wisconsin, finds that there are now, and may in the future be, vacant buildings which are dilapidated, unsafe, unhygienic and inadequately maintained so as to create or contribute to blight and so as to jeopardize the health, safety, prosperity and general welfare, and so as to create a public and/or private nuisance.

C. Intent. The purpose of the Code is to establish the measures and requirements reasonably necessary to protect the health, safety and welfare of the public from the public nuisances, blight and negative market impact of vacant or abandoned buildings and structures.

28.03 PUBLIC RECORD

A. Finding. In addition to the purposes in Section 28.02, the City finds that vacant buildings are targets for vandalism, arson, and other illegal activities. The City still further finds that the public disclosure of the identification of any or all vacant buildings would provide to persons with criminal intentions a data source to locate vacant buildings in which to carry out illegal activity. While the City acknowledges the requirements of the Wisconsin Public Records Law embodied in Wisconsin Statutes §§ 19.31 through 19.39, and the strong public policy underpinning those statutes that all persons are entitled to the greatest possible information regarding the affairs of government, the City also recognizes that against that strong public policy, records custodians must balance contrary public policy such as that found by the City in this subsection A., that would weigh against disclosure of a particular document.

B. Policy. Prior to releasing any records that are received, created, or maintained pursuant to the provisions of this chapter or are received, created, or maintained to accomplish the purpose of this chapter, the records custodian will consider the intent of the City articulated in this section.

28.04 RULES OF INTERPRETATION AND DEFINITIONS

A. Rules of Interpretation.

1. **Tense.** Words used in the present tense shall be interpreted to include the future tense.
2. **Gender.** Words used stating or implying gender shall be interpreted to include the masculine, feminine and neuter.
3. **Number.** Words used implying the singular shall be interpreted to include the plural, where appropriate, and vice versa.
4. **"May" and "Shall".**
 - a. The word "may" is permissive.
 - b. The word "shall" is mandatory and not directory.

5. **"Used For"**. The phrase "used for" shall include the phrases "arranged for", "designed for", "intended for", "maintained for", and "arranged for".

B. Definitions.

1. **Accessory Building/Structure**. A detached building or structure on the same lot, with and of a nature customarily incidental and subordinate to the principal building or structure or use of the land; i.e., a child's playhouse, garden house, greenhouse, garage, carport, shed, fence, or retaining wall.

2. **Building**. Any Structure used or intended for supporting or sheltering any use or occupancy. For multi-unit structures, each non-residential unit is deemed a separate "building" subject to this chapter; in multi-unit structures, individual residential units are to be considered a part of the larger building that encompasses the other residential units.

3. **Code of General Ordinances**. The Code of General Ordinances for the City of Kenosha, Wisconsin, which includes the Vacant Building Code.

4. **Code Official**. The Director of the Department of City Inspections, or any duly authorized designee of the Director.

5. **Department**. The Department of City Inspections of the City of Kenosha, Wisconsin.

6. **Exterior Premises**. The open space on the premises or the portion of the premises upon which there is not a structure.

7. **Garbage**. The animal or vegetable waste resulting from the handling, preparation, cooking and consumption of food.

8. **Good Repair**. "Good Repair" shall mean free from blighting and hazardous conditions, clean and sanitary, and in a safe condition.

9. **Imminent Hazard**. A condition which could cause serious or life-threatening injury or death at any time.

10. **Mixed Occupancy**. Occupancy of a structure in part for residential use and in part for some other lawful use under the Zoning Ordinance, not accessory thereto.

11. **Occupied**. A building is occupied when it is open to the public, when a business or manufacturing activity is performed therein, when people reside therein, or when any personal property is moved therein. Any building or structure shall be deemed to be occupied if one or more persons actually conducts a lawful business or resides in all or any part of the building as the licensed business-occupant, or as the legal or equitable owner/occupant(s) or tenant(s) on a permanent, non-transient basis, or any combination of the same. For purposes of this Chapter, evidence offered to prove that a building is so occupied may include, but shall not be limited to, the regular receipt of delivery of regular mail through the U.S. Postal Service; proof of continual telephone, electric, gas, heating, water and sewer.

12. **Owner**. Every person, partnership, limited partnership, corporation, service corporation, limited liability company or partnership, or other legally-recognized entity or association, who alone or jointly or severally with others:

- a. Has the legal title to a Building or Structure;
- b. Has legal right or obligation to the care, charge, or control of any Building or Structure, in any capacity including, but not limited to, agent; executor, administrator, trustee, guardian, or personal representative of the estate of the holder of legal title; or an agent, trustee, receiver or other person appointed by court order with authority to have possession or control of the Building or Structure; or
- c. Is a mortgagee, where either:
 - (1) the mortgagee has obtained a judgment of foreclosure against the mortgagor with regard to the premises containing the Vacant Building or Structure; or
 - (2) the mortgage or note secured by the mortgage contains a provision authorizing the mortgagee to act to secure or repair the property of the mortgagor, and the mortgagor no longer maintains the vacant Building or Structure; or
- d. Is a land contract vendor, where either:

(1) the land contract vendor has obtained a judgment of foreclosure against the land contract vendee with regard to the premises containing the vacant Building or Structure; or

(2) the land contract contains a provision authorizing the land contract vendor to act to secure or repair the property of the vendee, and the vendee no longer maintains the Vacant Building or Structure.

e. "Owner" does not include any real estate licensee providing brokerage services in accordance with Wis. Stat. Chapter 452.

13. Partially Vacant. A multi-storied building or structure that has one (1) or more stories vacant.

14. Responsible Person. A natural person who is the owner, operator or manager of any structure or premises.

15. Rubbish. Combustible and noncombustible waste materials, except garbage. The term shall include the residue from the burning of wood, coal, coke, and other combustible materials, paper, rags, cartons, boxes, wood excelsior, rubber, leather, tree branches, yard trimmings, tin cans, metals, mineral matter, glass, crockery, and dust and other similar materials.

16. Secured. A Building that has a permanent door or window in each appropriate building opening that is secured to prevent unauthorized entry and has all of its door and window components, including frames, jambs, rails, stiles, muntins, mullions, panels, sashes, lights and panels intact and unbroken.

17. Structure. Anything constructed or erected, which requires location on the ground or attached to something having location on the ground.

18. Unified Business District. Any commercial building or group of commercial buildings comprised of permitted and/or conditional uses located on a lot or group of lots, which lot or group of lots has a common ownership, and which is planned, developed or functions as a unit.

19. Vacant. A building or structure shall be deemed to be vacant if no person or persons, currently conducts a lawfully licensed business, or lawfully resides or lives in any part of the building as the legal or equitable owner(s), tenant- occupant(s), owner-occupants or tenant(s) on a permanent, non transient basis. Vacant status is determined from a totality of circumstances. For purposes of this chapter only, rebuttable evidence of vacancy includes, but is not be limited to, low or no utility usage, lack of customary furnishing consistent with occupancy, accumulation of newspapers or fliers, and fixtures or window coverings which are not Secured.

20. Waste. "Waste" shall mean garbage, ashes, rubbish and trash, but not of an earthly or construction nature.

21. Weeds. "Weeds" or "Noxious Weeds" shall mean Canada thistle, leafy spurge, field bindweed (Creeping Jenny), Ambrosia trifida (commonly called Giant Ragweed), Arubosia trifida (commonly called Common Ragweed), and such other weeds as are defined in "Weeds of the Northern Central States, North Central Regional Research Publication No. 281, Bulletin 772", published by the University of Illinois at Urbana-Champaign, College of Agriculture, Agricultural Experiment Station.

22. Zoning Ordinance. The Zoning Ordinance for the City of Kenosha, Wisconsin.

C. Terms Defined Elsewhere. Where terms are not defined in this Code and are defined in other City Ordinances, Codes or ASHRAE and NFPA 70, such terms shall have the meanings ascribed to them therein.

D. Terms Not Defined. Where terms are not defined herein, or through the methods of interpretation authorized by this Section, such terms shall have ordinarily accepted meanings, such as the context indicates.

28.05 APPLICABILITY

A. General. The provisions of this Vacant Building Code shall apply to all manufacturing, commercial, institutional, residential, and mixed occupancy buildings vacant for one hundred eighty (180)

consecutive days, and all manufacturing, commercial and mixed occupancy buildings, which have been partially vacant for one hundred eighty (180) days.

Upon application to the Director of City Inspections, an exemption from the provisions of this code may be granted for a period of up to 365 days.

In the event an exemption is granted the premises must be maintained in a clean and sanitary condition with grass/weeds cut and snow removed and the building maintained in good condition during the exemption period consistent with The General Code. The exemption may be revoked for a failure of the applicant to maintain the Building or the premises associated with the Building free from violation of law.

Any one of the following circumstances may be a basis for an exemption from the provisions of this chapter:

1. A Building under active construction, rehabilitation, renovation or repair for which a Building Permit has been obtained.
2. A Building with a raze permit or with a raze order pending from the City of Kenosha.
3. A Building whose owner is actively seeking in good faith to rent or sell the building, which good faith is supported by evidence to the reasonable satisfaction of the Director of City Inspections of such activity.

B. Conflict. In any case where a provision of this Code is found to be in conflict with a provision of the Zoning Ordinance or any other provisions of the Code of General Ordinances, the provision which established the higher standard for the protection of the public health, safety and welfare shall prevail.

C. Application of Other Ordinances. Nothing contained herein shall be deemed to authorize the use of a structure or premises contrary to any other provision of the Code of General Ordinances or the Zoning Ordinance. Repairs, additions or alterations to a structure shall be done in accordance with the procedures and provisions of State law, **Chapter 9** of the Code of General Ordinances and NFPA 70. Nothing in this Vacant Building Code shall be construed to cancel, modify or set aside any provision of the Zoning Ordinance.

D. Existing Remedies. The provisions in this Code shall not be construed to abolish or impair existing remedies of the City, or its officers or agencies, under State laws or other City General or Zoning Ordinances relating to the removal or demolition of any structure which is dangerous, unsafe and unsanitary, or the abatement of public nuisances.

E. Historic Buildings. The provisions of this Code shall apply to structures designated by the Federal Government, State or City as historic buildings. Any work to said structures shall also comply with Chapter 15 of the Zoning Ordinance and Chapter 70 ILHR of the Wisconsin Administrative Code.

F. Referenced Statutes, Ordinances, Codes and Standards. The Statutes, Ordinances, Codes and standards referenced in this Code shall be incorporated herein by reference and be a part of the requirements of this Code to the prescribed extent of each such reference, and include amendments, renumbering and successor acts.

G. Requirements Not Covered By This Code. The requirements necessary for the strength, stability, or proper operation of an existing structure or equipment, or for the public safety, health and general welfare, not specifically covered by this Code, shall be determined by the Code Official, subject to a right of appeal to the Board of Housing Appeals.

28.06 SEVERABILITY

A. If any provision of this Vacant Building Code is, for any reason, held to be unconstitutional, invalid or unenforceable by any court of competent jurisdiction, such judgment shall not affect the validity of the remaining provisions of this Code, which shall remain in full force and effect.

B. If the application of any provision of this Vacant Building Code is for any reason held to be an invalid application to a particular premises or structure by any court of competent jurisdiction, such provision shall continue to apply and remain in full force and effect to any premises or structure not specifically included in said judgment.

28.07 CODE OFFICIAL

A. Code Official. The Code Official shall have the authority to exercise the powers and duties of the position specified in this Code. The Code Official shall administer and enforce this Code.

B. Code of Conduct. The Code Official, in administering and enforcing this Code, shall abide by the City of Kenosha's Code of Ethics and the Department's Code of Conduct.

C. Inspections. The Code Official has the power to inspect Premises and structures to determine compliance with this Code. All reports of such inspections shall be in writing, signed or initialed and dated. The Code Official is authorized to engage such expert opinion as deemed necessary to report upon unusual technical issues that arise in the course of their duties, in accordance with Department policy.

D. Right Of Entry. The Code Official is authorized to enter structures or Premises, at reasonable times, with the express or implied consent of the owner, operator or occupant, to inspect in accordance with the Department's Policy and Procedure for Entering Onto Private Property to conduct administrative interior and exterior inspections for Code administration and enforcement and Licensing/Permitting purposes specified in other ordinances. If entry is refused or not obtained, the Code Official is authorized to pursue recourse to obtain entry as provided by law.

E. Reinspections. Every owner, operator and occupant of a Premises shall cooperate with and facilitate reinspections of Premises at reasonable times pursuant to reasonable notice by the Code Official to determine Code compliance with an Order to Repair. Failure by said owner, operator or occupant to cooperate with and facilitate such reinspections by the Code Official shall be a violation of this Code.

F. Obstruction. No owner, or operator of a Premises may deny the Code Official the right to enter and inspect any portion thereof under the control of a lawful occupant where such occupant has consented to said entry and inspection.

G. Denial of Entrance. No occupant of a Premises shall obstruct the owner thereof from complying with any order(s) of the Code Official made under authority of this Code. Obstruction shall include the denial of entrance into a Premises at reasonable times pursuant to reasonable notice.

H. Identification. The Code Official shall carry Department issued identification when entering and inspecting Premises in the performance of their duties under this Code and display such identification, when asked.

I. Notices and Orders. The Code Official shall, as necessary, issue notices and orders to responsible persons and tenants, where relevant, to obtain compliance with this Code.

J. Department Records. The Director of the Department is responsible for keeping official records of all business and activities of the Department specified in the provisions of this Code in accordance with State and City record keeping requirements.

28.08 VACANT OR ABANDONED BUILDING OR STRUCTURE REQUIREMENTS

A. Vacant Building Permit. The owner of a vacant building or structure shall obtain a Vacant Building Permit for the period during which it is vacant. When a building or structure becomes vacant, as defined by this Code, the owner of the building or structure shall apply for and obtain a Vacant Building Permit and pay the fee, as set forth in Section 28.09.

Upon the expiration of a Vacant Building Permit, if the building or structure is still vacant, the owner shall arrange for an inspection of the building and premises with the Code Official pursuant to Section 28.09, and renew the permit within ten (10) days of expiration in the same manner as the expired permit. All renewed permits shall be subject to all conditions and obligations imposed by this Code.

B. Code Compliance. The owner of a vacant building or structure shall comply with all building, fire, property maintenance, zoning, and other applicable Codes or Ordinances, and shall apply for all necessary building, fire prevention and zoning permits upon application for a Vacant Building Permit.

C. Waste Removal. The owner of a vacant building or structure shall immediately remove all waste from the interior of the structure. The owner of a vacant building or structure shall also immediately remove any waste, debris or excessive vegetation from the exterior premises surrounding the vacant building or structure in accordance with the vacant building maintenance standards of this Code and the Code of General Ordinances.

D. Owner's Responsibility. The owner of a vacant building or structure shall immediately lock, barricade or secure all doors, windows and other openings in the building or structure to prohibit entry by unauthorized persons in accordance with the Vacant Building Maintenance Standards of this Code.

If the owner does not reside within the State, the owner shall provide to the Code Official, the name, address and telephone number of an agent who is available for service of process within the State of Wisconsin.

The owner shall provide to the Code Official, the name, address and telephone number of a manager who is a natural person who is available for contact by the Code Official at all times for emergency repairs and maintenance, and who will respond to the vacant building or structure when required by the Code Official.

The agent and manager may be the same person, and/or either may be a Responsible Person.

The owner shall notify the Code Official within thirty (30) business days of any changes to the name, address or telephone number of the agent or manager.

E. Owner's Obligations Continuous Through Term of Vacancy. The obligations of owners of a vacant building or structure are continuing obligations which are effective throughout the time of vacancy, as that term is defined in this Code.

28.09 VACANT BUILDING PERMIT; INSPECTION; MAINTENANCE STANDARDS; FEES

A. Permit Application. Application by the owner of a vacant building or structure for a Vacant Building Permit shall be made on a form provided by the Code Official. Applicants shall disclose all measures to be taken to ensure that the building will be kept weathertight, secure from trespassers, and safe for entry by police officers and firefighters in times of exigent circumstances or emergency. The application shall include, but not be limited to, the following:

1. Contact information for each owner. If the owner is other than a natural person or persons, the following shall apply, as appropriate:

a. If the owner is a corporation, limited liability company, limited or liability partnership, the registration statement shall provide the names and residence addresses of all responsible persons and the name and business address of the registered agent for service of process appointed pursuant to Wisconsin State Statutes.

b. If an estate, the name and business address of the personal representative of the estate.

c. If a trust, the names and addresses of the trustee or trustees.

d. If a partnership, the names and residence addresses of the partner or partners.

e. If another form of unincorporated association, the name and residence address of a responsible person.

- f. If an individual person, the name and residence address of that individual person.
2. Any rehabilitation or demolition plans.
3. An acknowledgment by the owner that grass and weeds shall not exceed a height of eight (8") inches, and that snow and ice shall be removed from the public right-of-way within twenty-four (24) hours of a snowfall.

B. Inspection of Premises.

1. **Purpose.** The Code Official, or his/her designee, may inspect vacant buildings to determine the structural integrity of the building, the repairs necessary to maintain structural integrity, to determine what repair actions must be undertaken to maintain the premises safe for entry of police officers and firefighters in times of exigent circumstances or emergency, that the building and its contents do not present an imminent hazard to the public during the time that the building remains vacant, and that the building and structure are in compliance with the Vacant Building Maintenance Standards.

2. **Inspector.** The Code Official, or his/her designee, may conduct inspections made pursuant to the provisions of this Vacant Building Code in conjunction with other inspectors of the Department, police officers, firefighters, or inspectors from other governmental bodies.

3. **Types of Inspections.**

a. **Code Official Directed.**

(1) **Implied Consent.** Any owner of a building, which is either the subject of a Vacant Building Permit or an application filed by a responsible person, for a Vacant Building Permit, is deemed to have given consent to inspections of the building.

(2) **Reinspections.** At any time subsequent to the issuance of an Order to Repair, the Code Official may conduct reinspections to determine compliance with the Order to Repair. Such reinspections will be conducted only after a reasonable time has been afforded to a responsible party to comply with portions of the Order. Reinspections are subject to reinspection fees under **Section 28.11**.

(3) **Emergency Inspections/Emergency Repairs.** If, at any time, the Code Official has reason to believe that an emergency situation exists with respect to the building, which tends to create an imminent hazard to health, welfare or safety of the general public, the Code Official may enter the building to inspect the premises, without notifying the responsible party or obtaining a warrant. If the Code Official finds an emergency situation exists in fact, which presents an imminent hazard to the health, welfare or safety of the general public, the maintenance of which, until such time as the responsible party could conduct the repairs, would be unreasonable, the Code Official may cause any reasonable action, including the employment of necessary labor and materials, to perform emergency repairs. Costs incurred in the performance of emergency repairs shall be paid by the City and the Code Official shall recover the costs through special assessments levied against the benefited property. A One Hundred (\$100.00) Dollar administrative fee for processing and administering the special assessment shall be added to the special assessment against the benefited property.

(4) **Inspections Made Pursuant To A Special Inspection Warrant.** If any responsible party takes any action contrary to the Implied Consent given by the owner in Section 28.09 B.3.a.(1), above, the owner hereby consents to the issuance of a Special Inspection Warrant by a judge of a court of competent jurisdiction, pursuant to Section 66.0119, Wisconsin Statutes, or any successor thereof. Any interior inspection made pursuant to a Special Inspection Warrant shall be deemed a reinspection for the purpose of imposition of fees pursuant to Section 28.11.

b. **Responsible Party Requests For Inspection.** Requests from responsible parties for inspections of buildings which are both subject to a Vacant Building Permit and are under the control of the requesting responsible party.

C. Issuance of Orders To Repair. The Code Official, upon inspection, shall issue orders to repair for work needed to:

1. Adequately protect the building from intrusion by trespassers and from deterioration by the weather in accordance with the Vacant Building Maintenance Standards set forth in this Code; and,
2. Ensure that allowing the building to remain will not be detrimental to the public health, safety and welfare, will not unreasonably interfere with the reasonable and lawful use and enjoyment of other premises within the neighborhood, and will not pose an extraordinary hazard to police officers or firefighters entering the premises in times of emergency.

When issuing such orders, the Code Official shall specify the time for completion of the work. All work done pursuant to this Section shall be done in compliance with the applicable Building, Fire, Property Maintenance and Zoning Codes and Ordinances.

D. Issuance of Vacant Building Permit. The Code Official shall issue a Vacant Building Permit upon being satisfied that the building has been inspected and is in compliance with the Vacant Building Maintenance Standards set forth in this Vacant Building Code, and is adequately protected from intrusion by trespassers and from deterioration by the weather. This Permit shall be effective for a period of three hundred sixty (360) days.

E. Vacant Building Maintenance Standards. A vacant building or structure shall be deemed adequately protected from intrusion by trespassers and from deterioration by the weather if it satisfies the following Vacant Building Maintenance Standards:

1. Building Openings. Doors, windows, areaways, and other openings shall be weathertight and secured against entry by birds, vermin and trespassers. Missing or broken glass in doors, windows and other such openings shall be repaired/replaced with glass. No building opening shall be boarded.

All first floor or ground level windows, doors and openings shall be free of any posters, paper or fabric coverings.

2. Roofs. The roof and flashings shall be sound and tight, not admit moisture, or have defects which might admit moisture, rain or roof draining; and, allow for drainage to prevent dampness or deterioration in the interior walls or interior of the building.

3. Drainage. The building storm drainage system shall be functional and installed in an approved manner, and allow discharge in an approved manner.

4. Building Structure. The building shall be maintained in good repair, structurally sound, and free from debris, rubbish and garbage. The building shall be maintained in a sanitary manner and in a manner that does not pose a threat to the public health, safety and welfare.

5. Structural Members. The structural members shall be free of deterioration and capable of safely bearing imposed dead and live loads.

6. Foundation Walls. The foundation walls shall be maintained structurally sound and in a sanitary condition so as not to pose a threat to the public health, safety and welfare, shall be capable of supporting the load which normal use may cause to be placed thereon, and shall be free from open cracks and breaks, free from leaks, and be animal and rat-proof.

7. Exterior Walls. The exterior walls shall be free of holes, breaks, and loose or rotting materials. Exposed metal, wood, or other surfaces shall be protected from the elements and against decay or rust by periodic applications of weather-coating materials, such as paint or similar surface treatment.

8. Decorative Features. The cornices, belt courses, corbels, terra cotta trim, wall facings and similar decorative features shall be safe, anchored and in good repair. Exposed metal, wood or other surfaces shall be protected from the elements and against decay or rust by periodic applications of weather-coating materials, such as paint or similar surface treatment.

9. Overhanging Extensions. All balconies, canopies, marquees, signs, metal awnings, stairways, fire escapes, standpipes, exhaust ducts and similar features shall be in good repair, anchored, safe and sound. Exposed metal and wood surfaces shall be protected from the elements and against decay or rust by periodic application of weather-coating materials, such as paint or similar surface treatment.

10. Chimneys and Towers. Chimneys, cooling towers, smokestacks and similar appurtenances shall be structurally safe and in good repair. Exposed metal and wood surfaces shall be protected from the elements and against decay or rust by periodic application of weather-coating materials, such as paint or similar surface treatment.

11. Walkways. Public walkways shall be in good repair, shall be safe for pedestrian travel, and shall be free of snow and ice. Snow and ice removal shall be completed within twenty-four (24) hours of a snowfall.

12. Accessory Building/Structures. Accessory buildings/structures such as garages, sheds and fences shall be free from safety, health and fire hazards; and, shall comply with these Vacant Building Maintenance Standards.

13. Exterior Premises. The premises upon which the structure or building is located shall be clean, safe, sanitary, free from waste, rubbish, garbage, excessive vegetation, exterior storage, and shall not pose a threat to the public health, welfare or safety.

F. Vacant Building Permit Fee. The Common Council shall from time to time, by Resolution, establish a Vacant Building Permit fee.

G. Unpaid Permit. If an application for a Vacant Building Permit is filed, and following mailing of a second notice of Permit fees due to the applicant, Permit fees, as provided for by this Chapter, remain unpaid, said fees shall be charged to the property owner of record as a special assessment against the real estate upon which the Permit is issued and shall be a lien upon the Premises until paid in full, with interest accruing on the unpaid balance at a rate of interest established in **Section 2.10** of the Code of General Ordinances. There shall also be a One Hundred (\$100.00) Dollar Administrative Fee added to the charge and special assessment to cover the administrative costs of charging and assessing the Premises.

28.10 BOARD OF HOUSING APPEALS

Appeal and Fee. Any person receiving a notice of violation and order which has been issued in connection with the enforcement of any provision of this Code and aggrieved thereby, may appeal the order and shall be granted a hearing on the matter before the Board of Housing Appeals, provided that such person shall file in the Office of the Department of City Inspections a written notice of appeal and request for hearing, setting forth a brief statement of the grounds therefor, within twenty (20) days after the date the notice of violation and order was served. Upon receipt of such appeal, the Board of Housing Appeals shall set a time and place for such hearing and shall give the petitioner written notice thereof. At such hearing the petitioner shall be given an opportunity to be heard and to show why such notice of violation and order should be modified or withdrawn. No appeal to the Board of Housing Appeals shall be deemed perfected or shall be heard until the appellant shall pay an appeal fee of Twenty-five (\$25.00) Dollars.

28.11 REINSPECTION FEES

To compensate the City for inspection and administrative costs related to the enforcement of this Chapter, an escalating fee established by the Common Council through resolution, may be charged for any reinspection following the initial inspection which resulted in a order for corrective action, and the first reinspection to determine compliance with an order for corrective action issued hereunder. There shall be no reinspection fee for a final inspection indicating compliance, or for a reinspection occurring during the period of an approved time extension granted for good cause and involving a good faith effort on the part of the property owner to comply with the order.

Reinspection fees which are not paid by or on behalf of the property owner within thirty (30) days of mailing an invoice to the property owner of record on the City tax roll shall be charged and collected as a special assessment against the real estate upon which the reinspections were made, and shall be a lien upon the real estate until paid in full, with interest accruing on the unpaid balance at the rate of seven (7%) percent per annum. There shall also be a One Hundred (\$100.00) Dollar administrative charge added to the charge and special assessment to cover the administrative costs of charging and specially assessing the property.

28.12 PENALTIES

A. Violation Penalties. Any person who shall violate a provision of this Code shall, upon conviction, be subject to a forfeiture of not more than One Thousand (\$1,000.00) Dollars; and, in addition, shall pay the costs and expenses of prosecution. Each day such violation continues shall be considered a separate offense. Failure to promptly pay said forfeiture shall subject the violator to be sentenced to the County Jail for a period not to exceed sixty (60) days.

B. Abatement of Violation. The imposition of the penalties herein prescribed shall not preclude the City Attorney from instituting appropriate action to restrain, correct, or abate a violation, or to prevent

illegal occupancy of a structure or premises, or to stop an illegal act, conduct business, or utilization of the structure or premises.

CHAPTER XXIX
STATEMENT OF ECONOMIC INTEREST
BY CITY OFFICERS, EMPLOYEES, CANDIDATES AND NOMINEES

29.01 DECLARATION OF POLICY

The proper operation of democratic government requires that public officers and employees be independent, impartial and responsible; that government decisions and policy be made in the public interest; that public offices and employment not be used for personal gain; and that the public have confidence in the integrity of its government. In recognition of these goals, the following shall apply to the City officers, employees, candidates and nominees specified in this Chapter. Nothing contained in this Chapter is intended to deny to any person rights granted by the United States Constitution, the Constitution of the State of Wisconsin, the laws of the State of Wisconsin, or labor agreements negotiated with certified employee bargaining units.

29.02 DEFINITIONS

The following definitions shall apply in the interpretation and enforcement of this Chapter.

A. Officer means the Mayor, City Administrator, Alderpersons and Department Heads. Officer shall not include the Municipal Court Judge who is governed by State law.

B. Employee means any person employed by the City of Kenosha whose duties and responsibilities include awarding or executing contracts for:

1. The purchase of supplies, services, material or equipment for or on behalf of the City of Kenosha.
2. The construction of public works for or on behalf of the City of Kenosha.
3. The sale or leasing of real property for or on behalf of the City of Kenosha.

Employee shall also mean any other person employed by the City of Kenosha designated by the Mayor to file a Statement of Economic Interest.

C. Candidate means any person who files nomination papers and a declaration of candidacy for elective City office. Candidate shall not include any person seeking the office of Municipal Court Judge who is governed by State law.

D. Nominee means any person nominated to serve on a City board, commission, authority or committee specified in Chapter I of the Code of General Ordinances.

E. Statement of Economic Interest means the City approved form denominated as the Statement of Economic Interest as may be amended from time to time which is required to be filed pursuant to this Chapter.

29.03 STATEMENT OF ECONOMIC INTEREST REQUIRED

The following persons shall file a completed Statement of Economic Interest with the City Clerk/Treasurer:

- A.** All officers of the City of Kenosha as defined in Section 29.02 A. of this Chapter.
- B.** All employees of the City of Kenosha as defined in Section 29.02 B. of this Chapter.
- C.** All candidates for elective City office as defined in Section 29.02 C. of this Chapter.

D. All nominees for a City board, commission, authority or committee as defined in Section 29.02 D. of this Chapter.

29.04 TIME FOR FILING

All City officers, employees, candidates and nominees required to file a completed Statement of Economic Interest pursuant to this Chapter shall do so within the following time limits:

- A. New officers and employees within thirty (30) days after taking their office or position. The Mayor or an Alderperson who has filed a completed Statement of Economic Interest as a candidate for the City office to which they have been elected shall not be required to file a Statement of Economic Interest unless the information contained in the Statement of Economic Interest on file with the City Clerk/Treasurer is no longer true, correct and complete in which case the Mayor or Alderperson shall be required to file a completed Statement of Economic Interest within the time provided in this Section 29.04 A.
- B. Current officers and employees within thirty (30) days after the effective date of this Ordinance.
- C. Candidates for elective City office by 4:30 P.M. on the next working day following the last day for the filing of nomination papers.

D. Nominees for a City board, commission, authority or committee prior to assuming the position to which they have been nominated. Nominees serving on the Common Council, a City board, commission, authority or committee who have filed a completed Statement of Economic Interest shall not be required to file a Statement of Economic Interest in order to be considered for nomination to another City board, commission, authority, or committee unless the information contained in the Statement of Economic Interest on file with the City Clerk/Treasurer is no longer true, correct and complete in which case the nominee shall be required to file a completed Statement of Economic Interest within the time provided in this Section 29.04 D.

29.05 INCOMPLETE STATEMENT OF ECONOMIC INTEREST

The completed Statement of Economic Interest maybe filed with the City Clerk/Treasurer electronically. All information sought by the Statement of Economic Interest must be provided or alternatively contain an affirmative statement that the information sought does not apply. Failure to do so shall render the Statement of Economic Interest incomplete. The City Clerk/Treasurer shall refuse to accept for filing an incomplete Statement of Economic Interest. The City Clerk/Treasurer shall not be responsible for determining or verifying the accuracy of any of the information provided on the Statement of Economic Interest. Submission of any incomplete Statement of Economic Interest for filing with the City Clerk/Treasurer shall not satisfy the requirements of this Ordinance.

29.06 PENALTY

A. Any City officer or employee, other than the Mayor or an Alderperson, subject to this Chapter who fails to file a Statement of Economic Interest within the time provided in Section 29.04 shall be notified in writing of their failure to do so by the City Clerk/Treasurer. The notice shall provide that the City officer or employee file a Statement of Economic Interest within ten (10) calendar days and that their failure to do so shall subject them to suspension without pay from their office or position until such time as compliance with this Chapter is achieved. The City Clerk/Treasurer shall report noncompliance to the Mayor who shall be responsible for suspending the non-compliant City officer or employee without pay from their office or position until compliance is achieved.

B. Any Mayor or Alderperson subject to this Chapter who fails to file a Statement of Economic Interest within the time provided in Section 29.04 shall be notified in writing of their failure to do so by the City Clerk/Treasurer. The notice shall provide that the Mayor or Alderperson file a Statement of Economic Interest within ten (10) calendar days and that their failure to do so shall subject them to the withholding of the payment of their salary and expenses. The City Clerk/Treasurer shall report noncompliance to the Director of Finance who shall be responsible for withholding payment of their salary and expenses until compliance is achieved.

C. Any candidate for elective City office subject to this Chapter who fails to file a Statement of Economic Interest within the time provided in Section 29.04 shall be precluded from having their name placed on the election ballot.

D. Any nominee for a City board, commission, authority or committee subject to this Chapter who fails to file a Statement of Economic Interest within the time provided in Section 29.04 shall be precluded from assuming the position to which they have been nominated.

CHAPTER XXX
CODE OF ETHICS

30.01 PURPOSE

The purpose of this Code is to establish a standard of ethical conduct for a Covered Person; require such financial disclosures as will enable this Code to be enforced; establish procedures to assist a Covered Person in determining their compliance with this Code before the fact and in establishing a lack of intent for a violation in the event of an inadvertent violation; and to provide for the enforcement of this Code.

30.02 DEFINITIONS

A. Code means this Code of Ethics.

B. Covered Person means any non-elected City officer or employee, any non-elected member of any City Board, Committee, Commission or Authority, and any employee of the Library, Museum, Housing Authority and Redevelopment Authority. For purposes of Section 30.06 E. of this Code, Covered Person also means any former non-elected City officer or employee.

Covered Person does not include any candidate for an elective City office, any individual holding an elective City office, or any individual holding an elective City office serving as a member of any City Board, Committee, Commission or Authority.

Any candidate for elective City office, except a candidate for municipal judge, is considered a candidate for local public office subject to the code of ethics for candidates set forth in Section 19.59 of the Wisconsin Statutes, as may be amended from time to time. Any candidate for municipal judge is considered a candidate for state public office subject to the code of ethics for public officials set forth in Sections 19.41-19.58 of the Wisconsin Statutes, as may be amended from time to time.

Any individual holding an elective City office, except the office of municipal judge, and any individual holding an elective City office serving as a member of any City Board, Committee, Commission or Authority is considered a local public official subject to the code of ethics for local government officials set forth in Section 19.59 of the Wisconsin Statutes as may be amended from time to time.

Any individual holding the office of municipal judge is considered a state public official subject to the code of ethics for public officials set forth in Sections 19.41-19.58 of the Wisconsin Statutes as may be amended from time to time.

C. Confidential Information means documents that are protected from disclosure under Wisconsin's Public Records Law as well as documents and conversations which are the subject of a closed session under Wisconsin's Open Meetings Law. Confidentiality shall cease with respect to the following as hereinafter specified:

1. Contracts & Leases - When a final agreement is approved and executed by the parties.
2. Litigation - When a final order or judgment has been entered by a court or administrative tribunal, and all appeal times have expired with regard to the final order or judgment, excepting matters of attorney/client privilege.
3. Claims Settlement Where No Litigation Exists - When a final release has been executed and received, excepting matters of attorney/client privilege.
4. Deeds and Easements - When a deed or easement is received and accepted.
5. Labor Negotiations - When a labor agreement is approved and executed.

Notwithstanding the above, the Mayor, City Administrator or Department Head responsible for any of the above may waive confidentiality, where a waiver will not damage the interest sought to be protected. However, in no event will the strategy used to achieve a given result be made public, nor will preliminary drafts of documents or agreements, unless required to document or support the City's position in a court of law or before any administrative agency.

D. Disclose, with respect to Confidential Information, means to provide, show or relate documents or conversations to a person who is not privy to Confidential Information or whose input is not essential or beneficial to the processing of a transaction.

E. Quasi-Judicial Capacity means to act in the capacity of an administrative hearing examiner, with respect to the following:

1. Employee disciplinary hearings before the Civil Service Commission, Board of Police and Fire Commissioners, or any other Board, Committee, Commission or Authority.

2. License or permit suspension, revocation and nonrenewal hearings before the hearing body designated by ordinance or state statute.

Quasi-Judicial Capacity shall not include the process of determining whether or not charges are to be filed or action taken, nor shall it include any legislative acts.

The quasi-judicial process shall commence for purposes of this Code at the time a formal written complaint or appeal is served and filed and shall terminate upon a final decision being made and filed by the hearing body.

30.03 POLICY

It is the declared policy of the City of Kenosha that a Covered Person act:

A. Impartially and responsibly.

B. Through the proper channels of the governmental structure.

C. In accordance with the policies promulgated by the Mayor and Common Council.

D. In obedience of all applicable laws, rules and regulations.

E. In a manner as will promote public confidence.

F. Without regard for personal gain attained through the use of their position, other than for authorized compensation.

G. Without regard to age, race, creed, religion, color, handicap, sex, national origin, ancestry or sexual orientation, unless permitted by law.

H. In accordance with employee work rules and relevant established standards of employee performance, where applicable.

I. Within the scope of their authority.

J. In full cooperation with other employees, except where prohibited by confidentiality.

30.04 CONSTRUCTION

This Code shall be construed so as to acknowledge that it is subordinate to Federal and State laws, rules and regulations governing specific Covered Person conduct, and also so as to acknowledge that it is subordinate to Federal and State constitutional rights of a Covered Person. In the event of a clear and unambiguous conflict, this Code, with respect to employees, shall be subordinate to the Civil Service Ordinance and to any applicable labor agreement.

30.05 APPLICATION OF CODE

Any Covered Person may protect themselves from the inadvertent violation of this Code by procuring a written advisory opinion from the City Attorney prior to acting. Any Covered Person who acts in accordance with said opinion shall not be subject to prosecution under this Code, even if such interpretation is later reversed or withdrawn.

Any Covered Person may mitigate the consequence of an inadvertent violation of this Code by making a full disclosure of any facts which would form a basis for determining a violation of this Code, prior to acting, as hereinafter provided. Such disclosure will not preclude prosecution under this Code in

the event of a violation thereof, but may be a mitigating factor which could lessen the severity of the offense and subsequent discipline. The required disclosure must be made in writing or noted in the minutes or record of proceedings of any unit or subunits of City government. Any Covered Person who is a member of any City Board, Commission or Authority, shall make such disclosure to said respective body. City Department Heads shall make said disclosure to the Mayor or City Administrator. Other employees shall make said disclosure to their Department Head. Employees of the Library, Museum, Housing Authority and Redevelopment Authority shall make said disclosure to their respective Director.

30.06 STANDARDS FOR ETHICAL CONDUCT

A. Crimes Against Government And Its Administration. No Covered Person may violate Chapter 946, Wisconsin Statutes, "Crimes against Government and its Administration".

B. Public Contracts, Financial Transactions, Real Estate Transactions And The Purchase Or Sale Of Material, Supplies Or Services. No Covered Person may vote on or participate in a decision-making capacity in any transaction involving a City contract, City financial transaction, City real estate transaction, or in the purchase or sale of any material, supplies or services under circumstances in which they have a personal financial interest therein.

C. Gifts.

1. No Covered Person within any calendar year, may accept any gift, favor, service, or thing of value, or combination or multiple thereof, from any one person, party, firm or corporation, which is related to City service or employment, which equals or is in excess of Fifty (\$50) Dollars.

2. No Covered Person, in the course of their service or employment, may give to any person any gift, favor, unauthorized service, or thing of value which may tend to gain any undue or improper favor for them or the City.

D. Personal Use of City Property. No Covered Person may use or permit the use of City property for personal financial gain.

E. Confidential Information.

1. No Covered Person may disclose any information gained during the course of their service or employment in a confidential capacity to any person, where not expressly or impliedly authorized to do so, unless and until such information is or becomes a public record.

2. No Covered Person may use any information gained during the course of their service or employment in a confidential capacity for their own personal financial gain unless and until such information is or becomes a public record.

The obligation to preserve confidentiality shall continue, following termination of service or employment, for so long as the City's need for confidentiality exists, unless and until such information is or becomes a public record.

F. Laws, Rules and Regulations. No Covered Person may, in the course of their service or employment, intentionally violate, cause to be violated, or direct to be violated any Federal, State or City law, rule or regulation.

G. Discrimination. No Covered Person may intentionally engage in any discriminatory conduct as prohibited by local, State or Federal law, rule or regulation.

H. Representing Private Interests. No Covered Person may represent any person or party before any City legislative, quasi-legislative, judicial or quasi-judicial body, other than for themselves or their spouse or child.

I. Political Activity.

1. No Covered Person may use, cause to be used, or direct to be used, any City personnel or equipment during working hours, for any political campaign.

2. No Covered Person may coerce any employee or person to contribute monetary or other assistance to any political candidate, party or purpose, or to otherwise restrict any employee or person in the free exercise of their constitutional rights in such regard, except where such restriction is imposed by law, rule or regulation.

J. Quasi-Judicial Hearings.

1. No Covered Person, while acting in a Quasi-Judicial Capacity, may have ex-parte communications, oral or written, initiated or received, with any person having an interest in the matter, outside of the scope of the formal hearing process, when said communication bears on the merits of any issue which is pending before their respective hearing body. Procedural issues are not deemed issues which bear on the merits. A matter shall not be deemed pending until a complaint has been filed. A Covered Person acts in a Quasi-Judicial Capacity when serving on a body which is engaged in conducting a due process hearing.

2. A Covered Person who inadvertently violates the above subsection, shall forthwith notify, in writing, their respective body of the act, date of circumstances, and names of persons involved, attaching a copy of any written communications thereto. A copy of such notice shall also be served upon the parties, or their respective attorneys, which are a party directly involved in the hearing process.

3. No Covered Person may influence or attempt to influence any person who is engaged in conducting a quasi-judicial hearing outside of the hearing process, with respect to the merits of any issue.

K. For Profit and Not-For-Profit Organization Affiliations. A Covered Person shall disclose any and all affiliation they may have with any for profit and not-for-profit organization seeking financial support from the City of Kenosha. Disclosure shall occur at the earliest time practicable and a Covered Person who is subject to Chapter 29 of the Code of General Ordinances shall make such disclosure on the Statement of Economic Interest required thereunder.

30.07 ENFORCEMENT

This Code shall be enforced by outside legal counsel, hereinafter known as the "Enforcing Officer". The Enforcing Officer shall be appointed on an as-needed basis by the City Attorney.

30.08 INVESTIGATION OF COMPLAINTS

A. Filing of Complaints. Any officer, employee, citizen of the City of Kenosha or person involved in any City transaction, may file a complaint against any named Covered Person with the Enforcing Officer through the City Human Resources Department alleging a violation of this Code. A separate complaint shall be required for each named Covered Person. Complaints must specify the date of the alleged offense and the provision of this Code alleged to have been violated. Allegations shall be deemed to be made upon personal knowledge unless stated as being made upon information and belief.

B. Investigation. The Enforcing Officer shall accept and investigate any verified complaint, submitted in writing, and signed and sworn to under oath from any authorized complainant, which states the name of any Covered Person alleged to have committed a violation of this Code and which sets forth the alleged violations. The Enforcing Officer, within ten (10) working days of the receipt thereof, shall forward to the accused Covered Person a copy of the complaint and a general statement of the applicable Code provisions. If the Enforcing Officer determines that the verified complaint, on its face, even if true, does not allege facts sufficient to constitute a violation of this Code, the Enforcing Officer shall dismiss the complaint and notify the complainant and the accused Covered Person. If the Enforcing Officer determines that the verified complaint, on its face, alleges facts, which, if true, may be sufficient to constitute a violation of this Code, the Enforcing Officer shall make an investigation with respect thereto. If the Enforcing Officer determines that the verified complaint was frivolous, the Enforcing Officer shall so state. The complaint shall be a public record upon filing. However, the investigation, while pending, shall be confidential in nature. The final disposition of the complaint shall be a public record.

Pursuant to any investigation conducted under this Chapter, the Enforcing Officer has the power to require any Covered Person to submit, in writing, such reports and answers to questions relevant to the

CODE OF GENERAL ORDINANCES, 2021 - KENOSHA, WISCONSIN

investigation as the Enforcing Officer may prescribe, such submission to be made within such period and under oath, or otherwise, as the Enforcing Officer may determine.

No investigation of any Covered Person may be commenced until the Covered Person, who is the subject of the investigation, has been furnished with a copy of the complaint as herein provided. Should the Enforcing Officer during the course of the investigation find probable cause to believe that violations other than those alleged in the verified complaint occurred, the Enforcing Officer may, on the Enforcing Officer's own motion, cause the complaint to be amended to include said violations and, in such event, the Enforcing Officer shall furnish the complainant and the Covered Person with a copy thereof, in the same manner as provided herein for new complaints.

C. Limitations. No complaint shall be made or processed before the Enforcing Officer where the alleged violation of this Code occurred after the effective date of this Code, but where the alleged violation of this Code occurred more than one (1) year prior to the date of the filing of a verified complaint with the City Human Resources Department.

D. Probable Cause of Violation. At the conclusion of the investigation, the Enforcing Officer shall make a determination of whether or not probable cause exists to believe that a violation of this Code has occurred. If the Enforcing Officer determines that no probable cause exists, the Enforcing Officer shall send written notice of such determination to the accused Covered Person and to the complainant as soon as practicable. If the Enforcing Officer determines that probable cause exists to believe that a violation of this Code has been committed, the Enforcing Officer may commence a civil forfeiture action in the City Municipal Court and/or recommend disciplinary action.

30.09 DISCIPLINE

Upon receipt of a Municipal Court Judgment that this Code had been violated, and/or recommendations by the Enforcing Officer for disciplinary action, a Covered Person may be disciplined by the appropriate disciplinary authority in accordance with Chapter 17 of the Wisconsin Statutes, where applicable or in accordance with other applicable law; but no Covered Person subject to the jurisdiction of the Civil Service Commission or to the Board of Police and Fire Commissioners shall be suspended or removed otherwise than as in accordance with said applicable laws, rules and regulations.

30.10 UNFOUNDED COMPLAINTS

In the event a Covered Person should be charged under this Code and the charges are dropped or dismissed, the Covered Person shall be paid by the City for the reasonable cost of their defense, upon assigning to the City any cause or action they may have for malicious prosecution. The City may pursue such assigned cause of action to recover the costs of defense against the person bringing the unfounded charges.

30.11 SEVERABILITY

If any provision of this Code is invalid or unconstitutional, or if the application of this Code to any person or circumstances is invalid or unconstitutional, as determined by a court of record, such invalidity or unconstitutionality shall not affect the other provisions or applications of this Code which can be given effect without the invalid or unconstitutional provision or application.

30.12 PENALTY

Any Covered Person who violates this Code shall be subject, upon conviction, to a forfeiture of not more than One Thousand (\$1,000) Dollars, plus the cost of prosecution for each violation, and in the event of failure to make timely payment thereof shall be committed to the County Jail for a period not to exceed thirty (30) days.

CHAPTER XXXI
INCINERATION

A. It shall be unlawful for any person, organization, firm or corporation to incinerate plastic or rubber material in the City limits of Kenosha.

B. Any person, firm or corporation, violating this Chapter shall be punished upon conviction by a civil forfeiture not less than Two Thousand (\$2,000) Dollars, nor more than Five Thousand (\$5,000) Dollars, together with the cost of the prosecution, and in default of payment thereof shall be imprisoned until such forfeiture and cost are paid, but not to exceed ninety (90) days. Each occurrence shall be considered a separate violation.

C. Definitions: Each occurrence means each day incineration occurred.

D. Purpose: The citizens of the City of Kenosha recognize the health impact of incineration of plastic and rubber; we, therefore, enact this Ordinance.

E. Effective Date: The effective date of this Ordinance shall be the first day of the month following which is at least thirty (30) days after the adoption of this Ordinance.

F. Separability. If any section, subsection, subdivision, paragraph, sentence, clause or phrase of this Chapter or any part thereof is for any reason held unconstitutional, such decision shall not affect the validity of the remaining portions of this Chapter or any part thereof.

DATE: CITY REFERENDUM
JUNE 5, 1990

CHAPTER XXXII
KENOSHA WATER UTILITY
WATER AND SEWERAGE SYSTEMS

- 32.01 Kenosha Water Utility - Definition
- 32.02 Management and Operation of Water, Sewerage, And Household Hazardous Waste
- 32.03 Board of Water Commissioners - Powers and Duties
- 32.04 General Manager
- 32.05 Rules and Regulations Governing the Water Utility
- 32.06 Rules and Regulations Governing the Water System
- 32.07 Rules and Regulations Governing the Sewerage System
- 32.08 Wastewater Regulations
- 32.09 Private Well Abandonment
- 32.10 Appeal
- 32.11 Violations and Penalties

32.01 DEFINITIONS

A. Chapter Definitions

The following terms shall have the meaning specified therefor in the accompanying definition. All other terms shall have their common meaning:

Accidental Discharge(s). An accidental discharge is a discharge which was not intentional and may include a discharge caused by gross negligence or wanton or reckless conduct.

Act. The Federal Water Pollution Control Act, also known as the Clean Water Act, as amended, 33 U.S.C. 1251, et seq.

Authorized Representative. The following are authorized representatives:

1. If a corporation, the president, secretary, treasurer, or vice president of the corporation in charge of principle business function; the manager of one or more manufacturing facilities provided the manager is authorized to make decisions which govern the operation of the facility, make major capital investment recommendations, initiate and direct comprehensive measures to assure long-term compliance with environmental laws, can ensure the necessary systems are established to gather complete and accurate information for the report and where authority to sign documents has been delegated to the manager according to the corporation's procedures; a representative authorized according to part 5;

2. If a limited liability company, a member if the liability company is registered with the Wisconsin Department of Financial Institutions or with its state of organization to operate through its members; a managing member or manager if the liability company is registered with the Wisconsin Department of Financial Institutions or with its state of organization to operate through its managing member(s) or manager, respectively;

3. If a limited partnership, the general partner or a representative authorized according to part 5;

4. If a sole proprietorship, the proprietor or a representative authorized according to part 5;

5. Authorized Representative may be delegated if:

a. An authorized representative of the individual designated above if (1) such representative is responsible for the overall operation of the facilities from which the discharge into the POTW originates, such as a plant manager, (2) such representative is responsible for the overall environmental matter for the company, such as a corporate environmental officer, and (3) the written authorization is submitted to the POTW. If circumstances change so that an authorization is no longer accurate, the industrial user shall submit a new authorization before or along with the submission of any report signed by a new representative.

Backflow. The undesirable flow of water or mixtures of water and other liquids, gases or other substances under positive or reduced pressure into the Utility distribution system of the potable supply of water from any source.

Backflow Preventer. A device or means designed to prevent backflow caused by backpressure or back-siphonage; most commonly categorized as air gap, reduced pressure principle backflow preventer, double check valve assembly, pressure vacuum breaker, atmospheric vacuum breaker, hose connection vacuum breaker, hose connection backflow preventer, backflow preventer with intermediate atmospheric vent, and barometric loop.

Backpressure. An elevation of pressure in the downstream piping system (i.e., pump, elevation or piping, or steam and/or air pressure) above the Utility supply pressure, which would cause or tend to cause a reversal of the normal direction of flow.

Back-siphonage. The flow of water or other liquids, mixtures or substances into the distribution pipes of the Utility's potable water supply system from any source caused by the sudden reduction of pressure in the Utility's potable water supply system.

Board. The Board of Water Commissioners created under the authority of **§1.06 H.** of the City of Kenosha Code of General Ordinances.

BOD (Biochemical Oxygen Demand). The BOD Concentration is the quantity of oxygen utilized in the biochemical oxidation of organic matter under standard laboratory conditions in five (5) days. BOD concentrations are expressed in milligrams per liter (mg/l).

Bypass. An intentional diversion of wastestreams from any portion of an industrial user's treatment facility or an intentional diversion of water by connection in front of or removal of the water meter.

CFR. Code of Federal Regulations.

Chlorine Requirement. The quantity of chlorine required to produce a residual amount of chlorine, measured in mg/l.

City. The City of Kenosha, Wisconsin, and its officers, employees, and agents.

Contaminate the Sludge. To cause sludge to become toxic or to otherwise interfere with the Water Utility's sludge management program. The term includes prevention of sewage sludge use or disposal by the POTW in accordance with §405 of the Act (33 U.S.C.1345) or any criteria, guidelines, or regulations developed pursuant to the Solid Waste Disposal Act (SWDA), the Clean Air Act, the Toxic Substances Control Act (TSCA), or more stringent State criteria (including those contained in any State sludge management plan prepared pursuant to Title IV of SWDA) applicable to the method of disposal or use employed by the POTW.

Cross-connection. Any physical connection or arrangement between two otherwise separate systems, one of which contains potable water from the Utility's public water system, and the other containing water from a private source, water of unknown or questionable safety, or steam, gases, or chemicals, whereby there may be a flow from one system to the other, the direction of flow depending on the pressure differential between the two systems.

Curb Stop. The curb stop is a shut off valve located at the connection point between the Water Utility's water service and the property owner's water service. The Water Utility owns and is responsible for the maintenance of the curb stop.

Customer. A person, regardless of whether or not that person is the Property Owner, who establishes an account with the Water Utility for provision of services from the Water Utility

Discharge. The intentional or accidental depositing of wastewater into the wastewater collection facilities.

Discharger. Any person who shall discharge wastewater into the wastewater collection facilities, either by discharging directly into such facilities within the Water Utility service area or by discharging into sanitary sewers within a municipality where such discharge flows into the Water Utility wastewater collection facilities.

Environmental Protection Agency (EPA). The United States Environmental Protection Agency, or where appropriate, the term may also be used as a designation for the Administrator or other duly authorized official of said agency.

Facility(ies). This term includes land, buildings, structures, the plant, equipment, and records.

Field Staking. The physical marking of the approximate location of a municipal water or sanitary sewer

stub, lateral, or wye.

Floatable Grease. Shall mean oil, fat or grease in a physical state such that it will separate, by gravity, from wastewater by treatment in an approved pretreatment device.

F.O.G. Fats, oils, or grease.

Food Service Establishment. Shall mean any facility engaged in preparing and/or packaging food or beverages for sale or consumption, on or off site, with the exception of private residences. Food Service establishments shall include, but are not limited to food courts, food manufacturers, food packagers, restaurants, grocery stores, convenience stores, bakeries, cafeterias, lounges, hospitals, correctional facilities, hotels, nursing homes, churches, day care facilities and schools.

Garbage Grinder. Shall mean a device that shreds or grinds up solid or semisolid waste materials into smaller particles for discharge into the wastewater collection system.

General Manager. The General Manager shall have the charge and management of the Water Utility, subject to Board supervision.

Grab Sample. Shall mean a sample that is taken from a wastewater discharge on a one-time basis with no regard to the volume of flow in the discharge.

Gray Water. Shall mean all of the liquid contained in a grease interceptor that lies below the floating grease layer and above the food solids layer.

Grease. Shall mean a material either liquid or solid, composed primarily of fat, oil and grease from animal or vegetable sources. The terms "fats, oils and grease" (FOG) and "oil and grease" shall be included within this definition.

Grease Interceptor. Shall mean a device whose rated flow exceeds fifty (50) gpm, which has a storage capacity of seven hundred fifty (750) gallons or more, and is located underground and outside a food service establishment. This device is designed to collect, contain and remove food wastes and grease from the waste stream while allowing the balance of the liquid waste to discharge to the wastewater collection system by gravity.

Grease Laden Waste. Shall mean liquid waste from fixtures which contains grease.

Grease Trap. Shall mean a device, whose rated flow is less than fifty (50) gpm, located inside a food service establishment and designed to collect, contain and remove food wastes and grease from the waste stream while allowing the balance of the liquid waste to discharge to the wastewater collection system by gravity.

Hauler. A person who picks up and transports septic or holding tank sewage and discharges same into wastewater collection facilities.

Industrial Discharger. Any building, structure, facility, or installation from which there is or may be a discharge of pollutants to the wastewater collection facilities.

Injure the System. To damage or destroy facilities being a part of the system; to cause an upset; to obstruct or interfere with the flow of wastewater anywhere in the system; to cause a public nuisance; or to cause a violation of the Water Utility WPDES Permit.

Intentional Discharge(s). A willful discharge, irrespective of whether or not the consequences of such discharge were known or anticipated by the discharger.

Interference. A discharge which alone or in conjunction with another discharge or discharges from other sources, inhibits or disrupts the POTW, its treatment processes or operations, or its sludge processes, use or disposal; and therefore is a cause of a violation of any requirement of the POTW's WPDES Permit (including an increase in the magnitude or duration of a violation) or of the prevention of sewage sludge use or disposal in compliance with regulations or permits issued thereunder.

Kenosha Water Utility (Water Utility). The Kenosha Water Utility of the City of Kenosha, Wisconsin, shall mean a municipally owned public water utility organized and existing under authority of §66.0805, Wisconsin Statutes, and this Chapter. The term Water Utility shall include its officers, employees and agents.

Laboratory Supervisor. A Water Utility employee responsible for the administration of the Industrial Pretreatment Program as authorized by this Chapter.

Law(ful). Includes Federal, State and local laws, rules and regulations. Lawful means in compliance with Federal, State and local laws, rules, regulations and orders promulgated under the authority thereof.

Milligrams per Liter (mg/l). The weight-to-volume ratio used to express a concentration. Milligrams

per liter and parts per million (ppm) are alternate means of expressing the ratio.

Municipality. Any Town, Village, or Sanitary District that is located within the County of Kenosha and discharges wastewater from its service area into the Water Utility wastewater collection facilities.

National Categorical Pretreatment Standard or NCPS. A regulation containing pollutant discharge limits promulgated by the EPA in accordance with §§307(b) and (c) of the Act, which apply to specific industrial discharges.

New Source. Any building, structure, facility, or installation from which there is or may be a discharge of pollutants, the construction of which commenced after the publication of proposed pretreatment standards under §307 of the Act that will be applicable to such source if such standards are thereafter promulgated in accordance with that section, provided that:

The building, structure, facility, or installation is constructed at a site at which no other source is located; or

The building, structure, facility or installation totally replaces the process or production equipment that causes the discharge of pollutants at an existing source; or,

The production of wastewater generating processes of the building, structure, facility, or installation are substantially independent of an existing source at the same site. In determining whether these are substantially independent processes, factors such as the extent to which the new facility is engaged in the same general type of activity as the existing source, should be considered.

Nonconventional Pollutant(s). Any and all pollutants which are not characteristic of normal domestic strength wastewater.

Normal Domestic Strength Wastewater. Wastewater with concentrations of BOD no greater than 200 mg/l, total suspended solids no greater than 250 mg/l, phosphorus no greater than 5.0 mg/l, and oil no greater than 100 mg/l.

Notice of Violation (NOV). Shall mean a written notice informing a user that a violation has occurred.

Notify. Shall mean contact by telephone, in person, or via certified United States mail, return receipt requested.

Opportunity for Hearing. The affording of a hearing otherwise required by this Chapter to any person who may be directly affected by the operation of this Chapter, provided that such person files a timely written request for a hearing with the General Manager of the Water Utility.

Owner. Any person having a title to the premises, as recorded in the Office of the Register of Deeds for Kenosha County, or as recorded in the City of Kenosha assessment rolls.

Pass Through. A discharge which exits the POTW into waters of the State in quantities or concentrations which, alone or in conjunction with a discharge or discharges from other sources, is a cause of a violation of any requirement of the POTW's WPDES Permit (including an increase in the magnitude or duration of a violation).

Permit. Provides written permission to perform certain specified acts.

Person. Any and all persons, including an individual, partnership, firm, company, municipality, corporation, association, society, institution, enterprise, governmental agency, or any other entity.

pH. The logarithm of the reciprocal of the hydrogen-ion concentration. The concentration is measured in Standard Units (SU).

Phosphorus or P. The element phosphorus. The measurement of phosphorus is expressed in mg/l.

Potable Water. Water which is fit for human consumption without further treatment.

POTW. Publicly Owned Treatment Works.

Premises. Shall mean a parcel of real estate or portion thereof including any improvements thereon which is determined by the Water Utility to be a single user for the purposes of receiving, using and paying for water and/or sewer services.

Publicly Owned Treatment Works. The publicly owned facilities designed and used for the treatment of wastewater prior to discharge thereof into the receiving stream. Wastewater treatment facility and POTW have the same meaning. In Kenosha, the POTW is the wastewater treatment plant located at 7834 - 3rd Avenue. Within the scope of this Ordinance, the POTW is the delegated Control Authority for the

CODE OF GENERAL ORDINANCES, 2021 - KENOSHA, WISCONSIN

Industrial Pretreatment Program.

Priority Pollutant(s). The elements and compounds listed below:

Chemical Name	CAS Registry Number (or EDF Substance ID)
ACENAPHTHENE	83-32-9
ACENAPHTHYLENE	208-96-8
ACROLEIN	39120
ACRYLONITRILE	39447
ALDRIN	0
ALPHA-ENDOSULFAN	959-98-8
ALPHA-LINDANE	319-84-6
ANTHRACENE	44171
ANTIMONY	7440-36-0
AROCLOR 1016	3935426
AROCLOR 1221	11104-28-2
AROCLOR 1232	11141-16-5
AROCLOR 1242	53469-21-9
AROCLOR 1248	12672-29-6
AROCLOR 1254	11097-69-1
AROCLOR 1260	11096-82-5
ARSENIC	7440-38-2
ASBESTOS (FRIABLE)	1332-21-4
BENZ(A)ANTHRACENE	56-55-3
BENZENE	71-43-2
BENZIDINE	92-87-5
BENZO(A)PYRENE	50-32-8
BENZO(B)FLUORANTHENE	205-99-2
BENZO(GHI)PERYLENE	191-24-2
BENZO(K)FLUORANTHENE	75826
BENZYL BUTYL PHTHALATE	85-68-7
BERYLLIUM	7440-41-7
BETA-ENDOSULFAN	33213-65-9
BETA-LINDANE	319-85-7
BIS(2-CHLORO-1-METHYLETHYL) ETHER	108-60-1
BIS(2-CHLOROETHOXY)METHANE	111-91-1
BIS(2-CHLOROETHYL) ETHER	111-44-4
BIS(2-CHLOROISOPROPYL) ETHER	39638-32-9
BIS(2-ETHYLHEXYL)PHTHALATE	117-81-7
BIS(CHLOROMETHYL) ETHER	542-88-1
4-BROMOPHENYL PHENYL ETHER	101-55-3
CADMIUM	7440-43-9
CAMPHECHLOR	8001-35-2
CARBON TETRACHLORIDE	56-23-5
4-CHLOR-M-CRESOL	59-50-7
CHLORDANE	57-74-9
CHLOROBENZENE	108-90-7
CHLORODIBROMOMETHANE	124-48-1
CHLOROETHANE	0
2-CHLOROETHYL VINYL ETHER	110-75-8
CHLOROFORM	67-66-3
CHLOROMETHANE	74-87-3
2-CHLORONAPHTHALENE	91-58-7
2-CHLOROPHENOL	95-57-8
4-CHLOROPHENYL PHENYL ETHER	7005-72-3
CHROMIUM	7440-47-3
CHRYSENE	79632

CODE OF GENERAL ORDINANCES, 2021 - KENOSHA, WISCONSIN

COPPER	7440-50-8
CYANIDE	21158
DDD	72-54-8
DDE	72-55-9
DDT	50-29-3
DELTA-LINDANE	319-86-8
DI-N-OCTYL PHTHALATE	117-84-0
DI-N-PROPYLNITROSAMINE	621-64-7
DIBENZ(A,H)ANTHRACENE	53-70-3
1,2-DIBROMOETHANE	106-93-4
DIBUTYL PHTHALATE	84-74-2
1,4-DICHLOROBENZENE	106-46-7
1,2-DICHLOROBENZENE	95-50-1
1,3-DICHLOROBENZENE	541-73-1
3,3'-DICHLOROBENZIDINE	91-94-1
DICHLOROBROMOMETHANE	75-27-4
1,2-DICHLOROETHANE	39234
1,1-DICHLOROETHANE	75-34-3
1,1-DICHLOROETHYLENE	75-35-4
DICHLOROMETHANE	27638
2,4-DICHLOROPHENOL	120-83-2
1,2-DICHLOROPROPANE	78-87-5
1,3-DICHLOROPROPENE (MIXED ISOMERS)	542-75-6
DIELDRIN	60-57-1
DIETHYL PHTHALATE	84-66-2
DIMETHYL PHTHALATE	48154
2,4-DIMETHYLPHENOL	105-67-9
4,6-DINITRO-O-CRESOL	534-52-1
2,4-DINITROPHENOL	51-28-5
2,4-DINITROTOLUENE	121-14-2
2,6-DINITROTOLUENE	606-20-2
1,2-DIPHENYLHYDRAZINE	122-66-7
ENDOSULFAN SULFATE	376754
ENDRIN	72-20-8
ENDRIN ALDEHYDE	7421-93-4
ETHYLBENZENE	100-41-4
FLUORANTHENE	206-44-0
FLUORENE	86-73-7
GAMMA-LINDANE	58-89-9
HEPTACHLOR	76-44-8
HEPTACHLOR EPOXIDE	1024-57-3
HEXACHLORO-1,3-BUTADIENE	87-68-3
HEXACHLOROBENZENE	118-74-1
HEXACHLOROCYCLOPENTADIENE	77-47-4
HEXACHLOROETHANE	67-72-1
INDENO(1,2,3-CD)PYRENE	193-39-5
ISOPHORONE	78-59-1
LEAD	7439-92-1
MERCURY	7439-97-6
METHANAMINE, -METHYL-N-NITroso	62-75-9

CODE OF GENERAL ORDINANCES, 2021 - KENOSHA, WISCONSIN

METHYL BROMIDE	74-83-9
N-NITROSODIPHENYLAMINE	86-30-6
NAPHTHALENE	91-20-3
NICKEL	2023472
NITROBENZENE	98-95-3
4-NITROPHENOL	36562
2-NITROPHENOL	88-75-5
PENTACHLOROPHENOL	87-86-5
PHENANTHRENE	31054
PHENOL	108-95-2
PYRENE	0
SELENIUM	7782-49-2
SILVER	7440-22-4
2,3,7,8-TETRACHLORODIBENZO-P	
DIOXIN (TCDD)	637719
1,1,2,2-TETRACHLOROETHANE	79-34-5
TETRACHLOROETHYLENE	127-18-4
2,3,4,6-TETRACHLOROPHENOL	58-90-2
THALLIUM	7440-28-0
TOLUENE	108-88-3
1,2-TRANS-DICHLOROETHYLENE	156-60-5
TRIBROMOMETHANE	75-25-2
1,2,4-TRICHLOROBENZENE	120-82-1
1,1,2-TRICHLOROETHANE	0
1,1,1-TRICHLOROETHANE	71-55-6
TRICHLOROETHYLENE	28860
2,4,6-TRICHLOROPHENOL	32295
VINYL CHLORIDE	75-01-4
ZINC	7440-66-6

Process Water. Water that is utilized in any industrial or commercial operation.

Prohibited Wastewater. *Wastewater which shall not be discharged into the wastewater collection facilities unless and until authorized under the terms of a Wastewater Discharge Permit.*

Receiving Stream. The body of water into which treated or untreated wastewater is discharged. Lake Michigan is the receiving stream for the Water Utility POTW.

Sanitary Sewer. A pipe or conduit designed and used to transport wastewater.

Service Charge(s). The various fees to be paid by dischargers discharging to (users of) the wastewater collection facilities determined by the Board in accordance with any law and in accordance with orders of the Wisconsin Public Service Commission and Wisconsin Department of Natural Resources, as applicable.

Severe Property Damage. Any substantial physical damage to property, damage to the treatment facilities which causes them to become inoperable, or substantial and permanent loss of natural resources which can reasonably be expected to occur in the absence of a bypass. Severe property damage does not mean economic loss caused by delays in production.

Standard Industrial Classification or SIC. A classification pursuant to the Standard Industrial Classification Manual issued by the Executive Office of the President, Office of Management and Budget.

Significant Industrial User or SIU. Any industrial user subject to Categorical Pretreatment Standards; uses an average of 25,000 gallons of process wastewater per day or more (excluding noncontact cooling and boiler blowdown wastewater), or has a potential for adversely affecting the wastewater collection facility operation, or for violating any local standard or requirement.

Significant Load. A discharge of conventional pollutants which is greater than normal domestic strength wastewater or which contain toxic or nonconventional pollutants in such quantity as to exceed limitations thereon imposed by law.

Significant Noncompliance (SNC).

A significant industrial user has been in significant noncompliance if any of paragraph 1-8 apply. A non-significant industrial user has been in significant noncompliance if paragraphs 3, 4 or 7 apply:

1. Any chronic violation of wastewater discharge limits, defined here as those in which sixty-six (66%)

CODE OF GENERAL ORDINANCES, 2021 - KENOSHA, WISCONSIN

percent or more of all the measurements of the industrial user's wastewater discharge for the same pollutant parameter taken during a six-month period exceeded by any magnitude any numeric pretreatment standard or requirement including an instantaneous limit.

2. Any Technical Review Criteria (TRC) violations, defined here as those in which thirty-three (33%) percent or more of all the measurements of the industrial user's wastewater discharge for the same pollutant parameter taken during a six-month period equaled or exceeded the product of numeric pretreatment standard or requirement including an instantaneous limit multiplied by the applicable TRC = 1.4 for BOD, TSS, fats, oil and grease, 1.2 for all other pollutants except pH, or a pH limit by 0.4 standard units.

3. Any violation that the Water Utility believes has caused, alone or in combination with other discharges, interference or pass through (including endangering the health of Water Utility personnel or the general public);

4. Any discharge of a pollutant that caused imminent endangerment to human health, welfare or to the environment or has resulted in the POTW's exercise of its emergency authority.

5. Any failure to meet, within 90 days of the scheduled date, a compliance milestone contained in a Wastewater Discharge Permit or enforcement order for starting or completing construction, or attaining final compliance.

6. Any failure to provide, within 45 days of the due date, any required reports such as baseline monitoring reports, 90 day final compliance reports, periodic self-monitoring reports, and reports on compliance with compliance schedules, and failure to accurately report noncompliance.

7. Failure to accurately report noncompliance.

8. Any violation(s) which the Water Utility determines will adversely affect the implementation of pretreatment.

Sludge. A solid by-product of wastewater treatment removed from wastewater at the POTW. (Bio-solids)

Slug. Any discharge at a flow rate or concentration, which could cause a violation of the prohibited discharge standards in Rule 08-02(04) of this ordinance. A Slug Discharge is any Discharge of a non-routine, episodic nature, including but not limited to an accidental spill or a non-customary batch Discharge, which has a reasonable potential to cause Interference or Pass Through, or in any other way violate the POTW's regulations, Local Limits or Permit conditions.

Storm Sewer. A pipe or conduit designed and used to transport runoff water from precipitation or other unpolluted source.

Storm Water Collection Facilities. The storm sewers, structures, and equipment designed and used to collect and transport unpolluted water from the point of origin to the receiving stream.

System. Either individually or jointly, the wastewater collection facilities and the wastewater treatment facilities and all appurtenances thereof; or individually or jointly, the water distribution facilities and the water treatment facilities and all appurtenances.

Total Dissolved Solids or TDS. The quantity of solids dissolved in water, wastewater, or other liquids that are not removable by laboratory filtering, as prescribed in 40 CFR Part 136.

Total Suspended Solids or TSS. The quantity of solids that either float on the surface of, or are in suspension in, water, wastewater, or other liquids, and that are removable by laboratory filtering, as prescribed in 40 CFR Part 136.

Unpolluted Water. Water that may lawfully be deposited, without prior treatment, directly into the receiving stream. The term shall include, but not be limited to, potable water, and uncontaminated storm water, ground water, or surface runoff water.

Upset(s). An exceptional incident in which there is unintentional and temporary noncompliance with pretreatment standards because of factors beyond the reasonable control of the user. An upset does not include noncompliance to the extent caused by operational error, improperly designed treatment facilities, inadequate treatment facilities, lack of preventive maintenance, or careless or improper operation.

Utility. The Kenosha Water Utility.

Wastewater. The sewage, being a combination of liquids and solids carried in water, originating in residential, commercial and industrial facilities, and discharged into the wastewater collection facilities.

Wastewater Collection Facilities. The sanitary sewer mains, structure, and equipment designed and used to collect and transport wastewater from the point of discharge to the wastewater treatment facilities,

both within the City and within any municipality. This term shall include all sanitary sewers located at the wastewater treatment facility which carry wastewater prior to the treatment thereof.

Wisconsin Pollutant Discharge Elimination System Discharge Permit or WPDES. A document issued by the Wisconsin Department of Natural Resources which establishes effluent limitations and monitoring requirements for the Water Utility's POTW. WPDES Permit No. WI-0028703 and modifications thereof pertain to the Water Utility's POTW.

B. Terms.

1. Terms Defined Elsewhere. Where terms are not defined in this Code and are defined in other City Ordinances, Codes, or ASHRAE and NFPA 70, such terms shall have the meanings ascribed to them therein in those Codes.

2. Terms Not Defined. Where terms are not defined herein, or through the methods of interpretation authorized by this Section, such terms shall have ordinarily accepted meanings, such as the context indicates.

C. References.

All references herein to statutes, Wisconsin Administrative Code, ordinances, authoritative manuals shall include amendments made thereto from time to time.

Any Federal, State, or local laws, rules, and regulations, quoted herein are incorporated herein by reference, as they exist on the date of enactment of this Chapter and as they may be amended in the future. Should any reference thereto in this Chapter be incomplete or incorrect, the language of the applicable law, rule, or regulation shall nonetheless prevail.

1. Wisconsin Administrative Code. Wisconsin Administrative Code SPS 382 is hereby adopted, except any penalty provisions therein. Wisconsin Administrative Code NR 811 is hereby adopted.

2. Plumbing Code. This section does not supersede the State of Wisconsin Plumbing Code, SPS 381-384, or the City of Kenosha Plumbing Code, but is supplementary to them.

32.02 MANAGEMENT AND OPERATION OF WATER, SEWERAGE, AND HOUSEHOLD HAZARDOUS WASTE

The Water Utility shall have complete charge, management, and fiscal control of the operations of the Water, Sewerage, and Household Hazardous Waste Units. The general administration of the Water Utility shall be performed jointly for the Water, Sewerage and Household Hazardous Waste Units, under the direction of a General Manager, who shall report to the Board of Water Commissioners.

The Water Utility shall consist of three (3) separate fiscal units, as follows:

A. Water System. The Water System shall consist of the Water Treatment, Pumping, Storage, and Distribution facilities and related personnel.

B. Sewerage System. The Sewerage System shall consist of the Wastewater Treatment and Wastewater Collection facilities and related personnel.

C. Household Hazardous Waste System. The Household Hazardous Waste System shall consist of the collection and disposal of Household Hazardous Waste and related facilities and personnel.

32.03 BOARD OF WATER COMMISSIONERS - Powers and Duties

The Board is established pursuant to Chapter 1.06 H of the City of Kenosha Code of General Ordinances, and §66.0805, Wisconsin Statutes. The Board shall have the entire charge and management of the Water Utility as provided in Wisconsin Statutes, and this Chapter. The powers and duties of the Board shall include, but not be limited to the following:

- A.** Establish policy.
- B.** Adopt Rules and Regulations.
- C.** Adopt an annual budget.

CODE OF GENERAL ORDINANCES, 2021 - KENOSHA, WISCONSIN

- D. Establish and authorize compensation for the General Manager and Water Utility employees.
- E. Establish and authorize charges, assessments, rates and other fees for the Water System Sewerage System and Household Hazardous Waste System.
- F. Install, construct, and pay for public improvements, financed through bond issues, promissory notes, grants, Water Utility funds, or other funding sources.
- G. Enter into contracts and agreements, including cooperation agreements with other units of government, and enter into development agreements with subdividers, real estate owners, developers and others.
- H. Recover all or part of the cost of installing and constructing public improvements through impact fees or special assessments as authorized in §66.0701 and 66.0703, Wisconsin Statutes, and this Chapter.
- I. Purchase and sell real estate and Water Utility assets, acquire and release easements, enter into right of entry agreements, and enter into leases and rental agreements.
- J. Authorize the installation and construction of water or sewer infrastructure by Water Utility employees or through public construction contracts.
- K. Appoint a General Manager to direct the operations of the Utility.

32.04 GENERAL MANAGER

The Board shall appoint a General Manager who shall take and hold office under the City of Kenosha Civil Service Ordinance and Rules and Regulations, which are incorporated herein by reference. The General Manager shall have the full charge and management of the Water Utility, subject to Board supervision, and the authority to execute contracts, easements, agreements; hire, direct and manage Utility personnel; implement the Operating Budget and Capital Improvement Program; and perform other activities approved or directed by the Board. The Assistant General Manager shall have authority to act for the General Manager in his/her absence, or unavailability. When the term General Manager is used in this Chapter, it shall include authorized designees thereof.

32.05 RULES AND REGULATIONS GOVERNING THE WATER UTILITY

Rule 05-01. Wisconsin Statutes. All Wisconsin Statutes as they now exist or as they may hereinafter be amended relative to water service and sanitary sewer service are incorporated herein by reference and made a part of this Chapter as if fully set forth herein.

Rule 05-02. Wisconsin Administrative Code. All provisions of the Wisconsin Administrative Code as they now exist or as they may hereinafter be amended relative to water service and sanitary sewer service are incorporated herein by reference and made a part of this Chapter as if fully set forth herein.

Rule 05-03. Compliance with Rules. All persons now receiving water and/or sanitary sewer service from the Water Utility, or who may request service in the future, shall be considered as having agreed to be bound by the rules and regulations as filed with the Public Service Commission of Wisconsin and Chapter XXXII of the City of Kenosha Code of General Ordinances.

Rule 05-04. Inspection of Premises. During reasonable hours, any officer or authorized employee of the Water Utility shall have the right of access to the premises supplied with service for the purpose of inspection or for the enforcement of the Water Utility's rules and regulations. See § 196.171, Wisconsin Statutes.

Rule 05-05. Water and/or Sanitary Sewer Main Extensions.

A. The Board may, whenever it deems it expedient and necessary and in the best interests of the Water Utility, construct water and/or sanitary sewer mains, connections and appurtenances in any highway, street, right of way or utility easement. The cost of such main may be specially assessed against the benefitted property as provided for in §66.0703, Wisconsin Statutes, and this Chapter or pursuant to the terms of a developer's agreement with owner/developer of property to be served.

B. Where the cost of the extension is to be collected through assessment by the Water Utility against the abutting properties, the procedure set forth under §66.0703 Wisconsin Statutes shall apply, and no additional customer contribution to the Water Utility will be required.

C. Where the Water Utility is unwilling or unable to make a special assessment, the extension will be made on a customer-financed basis as follows:

1. The applicant(s) will advance, as a contribution in aid of construction, the total amount equivalent to that which would have been assessed for all property under paragraph A.

2. Part of the contribution required in B.1. will be refundable. When additional customers are connected to the extended main within 10 years of the date of completion, contributions in aid of construction will be collected equal to the amount which would have been assessed under A. for the abutting property being served. This amount will be refunded to the original contributor(s). In no case will the contributions received from additional customers exceed the proportionate amount which would have been required under A., nor will it exceed the total assessable cost of the original extension.

D. When a customer connects to a transmission main or connecting loop installed at Water Utility expense there will be a contribution required of an amount equivalent to that which would have been assessed under A.

Rule 05-06. Water and Sanitary Sewer Mains - How Constructed on Divided Property.

Construction of water and sanitary sewer mains which are to serve land divided by a plat of Subdivision, certified survey or plat of survey shall be in conformance with **Chapter 17** of the City of Kenosha Code of General Ordinances and in accordance with Water Utility plans and specifications. Water and sanitary sewer mains may be constructed to serve land divided under **Chapter 17** of the Code of General Ordinances only in accordance with a developer's agreement approved by the Board and executed by the General Manager of the Water Utility, and then, subject to the final approval and acceptance by the General Manager of the Water Utility.

A developer or subdivider shall pay to the Water Utility for the Water Utility's cost of any existing water or sanitary sewer which is extended to the property and will be used as main extensions, if the said extension had not previously been paid for.

Rule 05-07. Water Main Installation in Wholesale Areas. The Water Utility has entered into "Multi-Municipality Cooperation Agreements" which have been adopted by the governing bodies and are, therefore, authorized as they apply to main extensions in wholesale areas.

Rule 05-08. Water Main and Sanitary Sewer Main Special Assessments. Whenever the Board shall cause to be constructed a water main or a sanitary sewer main in any highway or street, right-of-way, or utility easement, which is not subject to a developer's agreement, the Water Utility, when legally possible, shall assess the abutting property owners for the cost thereof as provided for in this Chapter and in §66.0723, Wisconsin Statutes, as authorized by the Board. The special assessment may be based upon a charge per front foot of main installed or by another method of determining the cost to be assessed which is authorized by the Board to insure that property is assessed only to the extent benefitted and to permit recovery of the costs authorized by law.

Upon completion of construction and installation, the Water Utility will provide the property owner with written notice thereof and with an option of paying the special assessment therein in full within thirty (30) days or in ten (10) equal annual installments. The amount of each installment shall be equal to one-tenth (1/10th) of the total special assessment, plus interest at a rate determined by the Board. Special assessments shall be placed on the real estate tax roll and collected in the manner provided by law.

Rule 05-09. Water and Sanitary Sewer Design. Water and sanitary sewer plans and specifications shall be prepared or approved by the Water Utility. The Water Utility shall approve the size of water and sewer mains and the location of hydrants, valves, manholes and appurtenances thereto. Hydrant flow test information, if available, will be provided to designers by the Water Utility Engineering Division at no cost. Should additional hydrant flow testing information be required, the Water Utility Engineering Division will perform the necessary testing on a cost reimbursable basis. The fee for each hydrant test will be established by the Board.

Rule 05-10. Fire Hydrants. The cost of the installation of fire hydrants will not be specially assessed to abutting property owners, except as may be provided for in a developer's agreement.

Rule 05-11. Public Land Dedications. Special assessments shall not be forgiven or deferred as a consideration for any dedication of land for a public purpose, unless approved by the Board.

Rule 05-12. Railroad and Utility Company Special Assessments. Railroad and utility companies shall be specially assessed for all water and/or sanitary sewer mains fronting their property when and to the extent there is a benefit to the property.

Rule 05-13. Double Special Assessments. Generally, the cost of water and/or sanitary sewer mains shall be specially assessed against benefitted property on each side of a highway or street right-of-way. However, where property on one side of a highway or street right-of-way is the only beneficiary of such improvement or where the type or width of highway or street installed requires the installation of parallel water and/or sanitary sewer mains, the Board shall establish a special assessment rate to recover the cost thereof

CODE OF GENERAL ORDINANCES, 2021 - KENOSHA, WISCONSIN

which shall not exceed two (2) times the current special assessment front foot or other applicable rate which would have been otherwise applicable.

Rule 05-14. Special Assessment/Change of Circumstances. Special Assessments which were valid and enforceable when made shall not be forgiven due to a subsequent change in circumstances.

Rule 05-15. Hookup Fees. Whenever the Board shall cause to be installed or constructed a water and/or sanitary sewer main, and/or water or sanitary sewer connection in any highway or street, right-of-way or easement and said water or sanitary sewer main and/or water or sanitary sewer connection may not be assessed under §66.07, Wisconsin Statutes, due to lack of authority to do so, the abutting property owner shall, as a condition of being permitted to hookup to the Water Utility System where such a hookup is otherwise authorized and permitted, shall pay a "Hookup Fee".

The "Hookup Fee" may be established through the use of the front foot assessment rate or such other rate as is determined by the Board to recover the Water Utility's cost and expense of serving the property, plus any connection charge effective at the time of connection. The minimum "Hookup Fee" charge shall be for sixty feet times the then current assessment rate.

The "Hookup Fee" shall be charged for all property within or outside of the City Limits that was not previously assessed, or was subject to a deferred special assessment, under §66.07, Wisconsin Statutes, due to the lack of authority to do so at the time of construction or any other reason. Where a "Hookup Fee" is paid, a special assessment for the same service shall not later be made against the property.

Required connection fees shall be in addition to the "Hookup Fee".

Deferred special assessments for properties outside of the City limits are entered as such only for accounting purposes and only recorded if there is a reasonable likelihood of collection according to inter-municipal or inter-governmental agreements. Deferred special assessments in the City shall be noted as paid in the City's books of accounts upon a "Hookup Fee" being paid in an amount sufficient to cover the amount thereof.

"Hookup Fees" may be paid in installments upon the request of the property owner requesting service pursuant to a policy and interest rate determined by the Board and upon an agreement that unpaid fees may be specially assessed against benefitted property.

Rule 05-16. Deferred Special Assessments. No property within the City, unless zoned "agricultural", shall have any special assessment deferred for payment unless it is authorized by the Board, and then only pursuant to a uniform policy.

Rule 05-17. Deferred Special Assessments Payable Upon Annexation or Attachment. Upon annexation or attachment, all deferred special assessments for sanitary sewers, water mains, water services, and sewer laterals shall become due, owing, and payable in the same manner and to the same extent as if those assessments were validly assessed against said property on the effective date of annexation or attachment, except as heretofore provided. Deferred assessments for sanitary sewers, water mains, water services, and sewer laterals shall be due, owing, and payable at the charge or assessment rate prevailing on the effective date of annexation or attachment.

All deferred assessments shall be payable in installments where installment payments would have been available to any owner of property within the City for such improvements on the effective date of said annexation or attachment, although the annexing or attaching property owner(s) may, at their option, elect to pay the total amount due, owing, and payable forthwith.

Petitions for annexation shall contain a provision that in consideration for City approval of the petition for annexation, petitioners agree to the terms of this Chapter and waive any rights, if any, which they may have to contest the amounts due, owing and payable or the manner of payment heretofore enumerated, except for potential mathematical errors in calculations and except for a challenge based upon legal benefit to the property. However, the failure of any property owner to agree as above set forth shall not in and of itself void the obligations specified in this Chapter.

Rule 05-18. Method for Computing the Cost of Water and Sanitary Sewer Main Special Assessments.

A. Front Footage. Mains are to be specially assessed based upon the front footage of each parcel of land which abuts a main and appurtenances to the nearest one thousandth (.001) foot.

B. Corner Parcels. Any parcel which has at least two (2) sides which face two (2) intersecting streets at the intersection shall be specially assessed for the full length of the side upon which the main is first installed. When mains are later installed on the other abutting street of the corner parcel there shall be a special assessment for the full length of the side less a maximum credit of one hundred and fifty (150) feet.

C. Standard Symmetric Cul-de-Sacs. Parcels fronting a standard symmetric cul-de-sac shall be

especially assessed for the arc frontage.

Parcels which are tangent to a cul-de-sac, shall have a minimum special assessments based upon sixty (60') feet of frontage.

D. Offset or Nonsymmetric, Cul-de-Sacs. Parcels fronting offset or nonsymmetric cul-de-sacs shall be specially assessed in the same manner as a standard symmetric cul-de-sac.

E. Curved Streets. Parcels on curved streets shall be specially assessed for the frontage along the arc of the curve.

F. Corner Parcels on Curved Streets. Parcels on a curved street are considered corner parcels if there are intersecting streets. There shall be a maximum credit of one hundred and fifty (150') feet when the main covers the full length of the frontage. There shall be a minimum special assessment based upon sixty (60') feet of frontage.

G. Curved Streets with Partial Cul-de-Sacs. Parcels fronting a curved street which has a partial cul-de-sac on the outside radius of the curve shall be specially assessed for the arc frontage. Where the parcel is also a corner parcel, special assessments shall be levied in accordance with **Subsection F**.

H. Trapezoidal Parcels. Trapezoidal parcels (any four-sided lot with unequal interior angles) which have one side fronting a main shall be specially assessed based upon the frontage where the main is installed.

I. Triangular Parcels. Triangular parcels (three-sided lots with one side facing a street with a main) shall be specially assessed based upon frontage. Triangular parcels (three-sided lots with two sides facing streets with a main) shall be specially assessed as a corner parcel.

J. Double Frontage Parcels. Double frontage parcels (two sides facing two nonintersecting streets) shall be specially assessed only on the side(s) where the parcel is to be serviced.

K. Infrastructure Cost. The cost of providing infrastructure to serve the property may be built into the project assessment rate such as, but not limited to, water pumps, sanitary sewer lift stations, valves, manholes, facilities within intersections and right-of-way restoration.

Rule 05-19. Water Mains and Sanitary Sewer Mains and Connections Installed in Advance of Paving. Where streets are to be paved or repaved in full or part under circumstances where no sanitary sewers, water mains, water services and/or sewer laterals exist, the Water Utility may install the necessary sanitary sewers, water mains, water services and/or sewer laterals before the paving work is performed and specially assess the abutting property for the cost thereof in accordance with §66.07, Wisconsin Statutes, and this Chapter.

Rule 05-20 - Locating of Sanitary Lateral or Water Service Laterals. When requested to locate a sanitary sewer lateral or water service lateral, the Water Utility will field mark with a stake or paint the location per the latest records available. The records are available in the office of the Water Utility Engineering Services for review.

The Water Utility shall not be responsible for any costs to the owner, developer or other persons for any inaccuracy or incompleteness of the records or any misinterpretation of the records.

32.06 RULES AND REGULATIONS GOVERNING THE WATER SYSTEM

Rule 06-01. Required Water Service and Connection.

B. Unsafe Well Water. Where inhabited property that fronts a Water Utility water main is serviced by a private well, and where water from that well is bacteriologically unsafe or toxic, then the owner of said property shall be required to connect said property into an abutting water main and use Water Utility water for domestic purposes, subject to Water Utility Rules and Regulations, within thirty (30) calendar days following notification to the property owner that such a connection is required.

B. Safe Well Water. Where inhabited property that fronts a Water Utility water main is serviced by a private well that is subject to a Well Permit under §32.09, and the water from that well is bacteriologically safe, then the owner of said property shall be required to connect their property into an abutting water main within one (1) year. The connection shall be extended into the property and a water meter shall be set. (See §32.09) Water from the Water Utility need not be used as long as a Well Permit is maintained and the water from the well is bacteriologically safe.

Rule 06-02. Water Connection Charges. Owners shall be responsible, where the water main extension has been approved by the Water Utility through a developer's agreement, for the water service lateral installation costs from the main through the curb stop.

The initial water service lateral(s), not installed as part of a developer's agreement or an assessable Utility extension, will be installed from the main through the curb stop by the Water Utility, for which there will be charges as approved by the Wisconsin Public Service Commission.

Rule 06-03. Water Service Pipe. Water service pipe extending from the building to the Water Utility curb stop within the public right-of-way or easement, shall be installed in accordance with Wisconsin Administrative Code, SPS 382.

All curb stops for controlling the supply of water to customers shall be placed between the curb line of the street and sidewalk, where sidewalk is present or proposed, with the top of the box even with the grade of sidewalk or parkway. Representative detail drawings are on file at the Water Utility Engineering Office and are available for review upon request. Each water service lateral shall have a curb stop valve. When the water main is within ten (10') feet of the property line or within an easement, the tapping valve (corporation stop) of a service four (4") inch or greater in diameter may be considered to be the curb stop. If installed in this manner, the property owner is responsible for maintaining the entire water lateral, beginning at the tapping valve. The Utility is responsible for the tapping valve.

The minimum size of service pipe from the curb stop to the water meter shall be one (1") inch in diameter. The minimum size service from water main to curb stop for a residential unit, where the distance from the water main to the meter is greater than one hundred (100') feet, shall be one and one-half (1-1/2") inch diameter. In all cases the domestic service shall be sized to provide a minimum of 12 gpm at 20 psi at the water meter for each dwelling unit.

The water service from the curb stop to the building shall conform to the standards listed in Wisconsin Administrative Code, SPS 384. The water service from the main to the curb stop shall be type K copper for 1", 1-1/2" and 2" services; poly-encased ductile iron pipe Class 53 or C900 PVC pipe for 4", 6" and 8" services; and poly-encased ductile iron pipe Class 52 or C900 PVC pipe for services larger than 8". Alternate material may only be used upon written approval from the General Manager.

Water service pipe shall be laid at least five and one-half (5-1/2') feet below the planned finished grade of the street, lawn or below the existing grade, whichever is lower. The water service pipe may be laid in a sewer connection trench if it is properly shelved to one side of the trench or at least one (1') foot above the sewer lateral. No new or replacement service curb stop shall be laid deeper than six and one-half (6-1/2') feet below the established grade.

No person, party or contractor shall cover or permit the covering of any water connection line until the installation has been inspected and approved by the Utility. The contractor shall subject the water piping to a test in the presence of a City Plumbing Inspector, as required by the State Plumbing Code.

When a service pipe larger than two (2") inches is used to supply an individual service or a private water main extension, the service pipe shall be tested in accordance with Rule 06-36 prior to any pressure test or water usage.

A water service may cross one or more parcels to service another parcel provided only one parcel is served and the water service meets all of the following requirements/conditions:

1. Approved by the General Manager of the Water Utility;
2. A copy of a recorded easement between parcel owners is delivered to the Water Utility;
3. A "Deed Covenant - Rights to Maintain Sewer and/or Water" (approved by the City Attorney) is recorded and a copy of the recorded document is delivered to the Water Utility.

Rule 06-04. Responsibility for Water Service Pipes, Appurtenances and Connections. The Water Utility is responsible for any necessary repairs to or replacement of the water service pipe and curb stop, from the curb stop to the Water Utility's water distribution main located in an easement or in the public right-of-way. When the water main is within ten (10') feet of the property line or within an easement, the tapping valve (corporation stop) of a service four (4") inch or greater in diameter may be considered to be the curb stop. If installed in this manner, the property owner is responsible for maintaining the entire water lateral, beginning at the tapping valve. The Utility is responsible for the tapping valve.

CODE OF GENERAL ORDINANCES, 2021 - KENOSHA, WISCONSIN

The property owner is responsible for the installation, maintenance, and any necessary repairs to, or replacement of the water service pipe and all appurtenances and connections from within the building to the curb stop, except for the water meter and meter horn. The Water Utility is responsible for the installation, maintenance, and any repairs to, or replacement of the water meter and meter horn.

In the event any repair or replacement of the owner's water service pipe is required, the owner, at his/her expense, must make the repair or replacement within twenty (20) days after receiving written notice from the Water Utility that repair or replacement is required. If the necessary repair or replacement is not completed by the owner within said twenty (20) days, or if the condition requiring repair or replacement is of such a nature as to cause a danger to persons or property, the Water Utility may disconnect the water connection or make the necessary repair or replacement and charge the cost to the property owner, and specially assess the property served. Any costs or expenses incurred by the Water Utility which are the responsibility of the owner as stated in this Chapter, shall be charged to the property owner and may be specially assessed to the property served.

The Water Utility, as a public service, and upon the request of the property owner, may enter private property which receives its water supply from the Water Utility to attempt to locate a water pipe break. Under normal circumstances, the Water Utility will not perform or arrange to perform any repair work on private property. The Water Utility may, at its discretion, shut off water services to the premises without the consent of the owner or occupant, where there is evidence that the water pipe break may endanger persons, damage property, or create a public nuisance.

Rule 06-05. Water Service Leaks. If the Water Utility makes repairs to a water service pipe on the Water Utility's side and cannot reconnect to the service pipe on the homeowner's side because of a deteriorated service pipe or if the water service begins leaking during the Water Utility's maintenance to the meter or other Water Utility facilities, and it is determined that the owner's water service pipe must be replaced, then the Water Utility and the property owner shall equally share the cost of replacing the water service pipe on the owner's side.

Cost sharing shall only occur if the Water Utility attempted to reconnect or repair the water service pipe on the owner's side and determined that the service pipe on the owner's side requires replacement.

The property owner may arrange to have a contractor, acceptable to the Water Utility, replace or repair the water service pipe and then request 50 percent reimbursement of expenses from the Water Utility. Cost estimates must be approved by the General Manager prior to contracting the work.

The property owner shall be responsible for all costs for restoration on his/her property. The Water Utility shall be responsible for all costs for restoration of the right-of-way, including sidewalk, parkway, curb and gutter and road repairs.

Rule 06-06. Lead Service Replacement.

A. Intent and Purpose. Lead service lines have the potential to leach lead into drinking water. Disturbing or reconnecting to an existing lead service line may increase lead levels in drinking water. Elevated lead levels in drinking water have been determined to cause health problems in young children, pregnant women and their unborn children, and are also potentially harmful to adults. The Common Council therefore finds it in the public interest to establish a comprehensive program for removing and replacing all lead service lines within and connected to the Water Utility water distribution system.

B. Authority. This ordinance is enacted pursuant to §§ 62.11(5) and 196.372, Wisconsin Statutes.

C. Definitions. This ordinance shall be interpreted so that the intent and purpose described may be accomplished. Words and phrases shall be understood according to common meanings unless the contrary is clearly indicated. In addition to the definitions for this Chapter found in Section 32.01, definitions of terms used in this Section are listed below:

- 1. Customer-side service line.** The Property Owner's water service line, from the outlet of the curb stop to the inlet of the customer's water meter.
- 2. Distribution System.** The network of water pipes, including mains and service lines, owned and operated by the Water Utility.
- 3. Lead Service Line or LSL.** A water service line constructed of lead. The term includes the customer-side service line and/or the Utility-side service line.

CODE OF GENERAL ORDINANCES, 2021 - KENOSHA, WISCONSIN

4. **Property.** Real property as defined in § 70.03, Wisconsin Statutes.

5. **Property Owner.** A person or legal entity having a possessory interest, legal or equitable, in property, which defined term includes an estate, trust or lien.

6. **Plumbing Contractor.** A person, firm, corporation or other entity licensed by the State of Wisconsin to perform plumbing work in the City.

7. **Utility-side service line.** The Utility-owned portion of the water service line from the water main to the outlet of the curb stop, including the curb stop, but not the outlet joint of the curb stop.

D. Lead Service Line Replacement Requirement.

1. As provided in this ordinance, all existing lead service lines connected to the distribution system shall be replaced with water service lines constructed of materials approved by the City.

2. Where both the customer-side and Utility-side service lines are constructed of lead, the replacement of both sides of the service line shall be completed under a schedule established by the Utility.

3. Where only the customer-side service line is constructed of lead, the replacement of the customer-side LSL shall be completed under a schedule established by the Utility.

4. As of the effective date of this ordinance, no person, other than a Utility employee or agent, may connect a customer-side LSL to a non-lead Utility-side service line, except as a temporary emergency repair.

E. Identification of Lead Service Lines.

1. Upon notice from the Utility, any person or entity who owns, manages or otherwise exercises control over a property connected to the distribution system shall allow the Utility to inspect the customer-side service line to determine the material of construction. (See Rule 05-04.)

2. The Utility shall create and maintain a record of the location of all identified lead service lines in the City.

F. Private Replacements Done in Conjunction with Utility Replacements.

1. Prior to scheduling the replacement of Utility-side service lines, the General Manager, or his/her designee, shall inspect all affected customer-side service lines for the presence of lead. In the event that the Property Owner fails to provide access to the interior of any improvement to accomplish such inspection, the General Manager shall take such steps necessary to make the determination, and shall collect the cost therefore from the Property Owner, including by imposition of a special charge.

2. If the customer-side service line is found to be constructed of lead, the Property Owner will be notified in writing of that fact, along with notification that the Property Owner must replace the customer-side service line.

3. Replacement of the customer-side LSL must be completed by the Property Owner at the time the Utility-side service line is replaced unless an extension is allowed under subparagraph F.7.

4. A Property Owner having a customer-side LSL will be notified in writing at least forty-five (45) days prior to the date for scheduled replacement of the Utility-side service line.

5. Within thirty (30) days of receipt of the replacement notice, Property Owner must schedule replacement of the customer-side service lateral to coincide with the scheduled replacement of the Utility-side service line.

6. Failure to commence work on the replacement of the customer-side LSL when scheduled pursuant to this ordinance or to complete such work within a reasonable time after commencement of the work, may result in a citation for the violation to the Property Owner.

7. Upon written request of the Property Owner with demonstration by the Property Owner of a compelling need, the General Manager may, at his or her discretion, extend the time requirement for replacement of the customer-side LSL, unless the General Manager determines that doing so will create an imminent threat to the health, safety or welfare of the public.

G. Financial Assistance for Customer-Side LSL Replacements.

1. The Utility may provide an eligible Property Owner with financial assistance to replace a customer-side LSL if the Utility maintains a financial assistance program that has received the approval of the Public Service Commission of Wisconsin and that has available funding.

2. If the Utility maintains an approved financial assistance program, the Utility may provide eligible

CODE OF GENERAL ORDINANCES, 2021 - KENOSHA, WISCONSIN

Property Owners with a grant for up to fifty percent (50%) of the cost of customer-side LSL replacement, but not to exceed a maximum grant amount established by the Board of Water Commissioners. The Board of Water Commissioners shall periodically review and adjust the maximum grant amount.

3. Financial assistance granted to eligible Property Owners shall be in accordance with the following priority:

- a.** for Properties with leaking or failed customer-side or Utility-side service lines.
- b.** for Properties where the Water Utility is replacing the Utility-side service line, on either a planned

or emergency basis.

- c. for Properties with licensed child care facilities and schools.
 - d. for Properties where children under the age of seven (7) or pregnant women reside.
 - e. to all remaining Properties with customer-side LSLs.
4. A Property Owner is eligible for financial assistance for the purpose of replacing the customer-side LSL if the Property Owner satisfies all of the following criteria:
 - a. The Property Owner alone, or collectively with others, owns the entire fee simple title to the Property served by a customer-side LSL.
 - b. The Property Owner's customer-side LSL is either attached to a Utility-side service line that is not a LSL, or a Utility-side LSL scheduled for replacement and for which the Property Owner has been notified by the Utility of such scheduled replacement.
 - c. The Property Owner of subparagraph a, above, agrees to have the work done by a Utility-approved Plumbing Contractor and in compliance with this ordinance.
 - d. The Property Owner of subparagraph a, above, executes a temporary right of entry and construction easement authorizing the Utility access to the dwelling as needed.
5. Written applications for financial assistance shall include the following:
 - a. A completed application on a form furnished by the Utility signed by the Property Owner of subparagraph 4. a, above. The completed application form shall include a certification by the Property Owner that attests that all eligibility criteria are met.
 - b. The executed documentation required by paragraph G.4.
 - c. Copies of written quotes from at least two pre-qualified Plumbing Contractors for the replacement of the customer-side LSL. A pre-qualified Plumbing Contractor is one that either is on the Utility's Prequalified Plumbing Contractor list, or is a Plumbing Contractor that is properly licensed to work in the State of Wisconsin, has filled out a Prequalification Form at the Kenosha Water Utility office, and has been accepted by the Utility.
6. Prior to commencement of any work, the Utility shall determine if the Property Owner is eligible for financial assistance, and if there is money available to provide financial assistance to replace the customer-side LSL. Such determination shall be provided in writing to the Property Owner who applied.
7. Customer-side service line replacement work must be accomplished in a worker-like manner and be coordinated with any Utility replacement work as required by paragraph F.
8. Upon completion of the customer-side service line replacement, the Property Owner shall provide the Utility with a copy of the invoice from the Plumbing Contractor. Upon proof of completion satisfactory to the Utility, the Utility shall pay directly to the Plumbing Contractor the amount of financial assistance approved by the Utility for replacement of the customer-side LSL. The Utility shall notify the Property Owner of the payment.
9. In addition to the provision of grants, the Utility may provide financial assistance for customer-side LSL replacements in the form of loans. In accordance with § 66.0627, Wisconsin Statutes, the Utility shall require that an eligible Property Owner enter into a loan agreement, which provides that loan repayments be paid in annual installments, with installment payments being placed on the tax roll as a special charge. The total amount of grants and loans provided as financial assistance by the Utility may not exceed the actual cost of replacement of the customer-side LSL.
10. Disputes regarding eligibility for financing may be appealed to the Board of Water Commissioners.

H. Severability. If any subsection or portion of this ordinance is for any reason determined to be invalid or unconstitutional by the decision of a court of competent jurisdiction, that subsection or portion shall be deemed severable and shall not affect the validity of the remaining subsections or portions of this ordinance.

I. Authority to Discontinue Service. As an alternative to any other methods provided for obtaining compliance with this section regarding replacement of a customer-side LSL, the Utility may, after at least thirty (30) days of giving notice, discontinue water service to such property served by customer-side service LSL after reasonable opportunity has been given to make the appropriate replacement.

Rule 06-07. Frozen Laterals.

- A. Thawing of a customer's lateral shall be at the Water Utility's expense if:

CODE OF GENERAL ORDINANCES, 2021 - KENOSHA, WISCONSIN

1. The frozen lateral is a direct result of a Water Utility disconnect and the disconnection occurs during a time when conditions are such that frozen lateral could reasonably be expected to occur or;
2. The customer's portion of lateral is electrically conductive and:
 - a. It is the first thaw for the customer at the location during the current winter season and;
 - b. The Water Utility has not provided the customer with seasonal notice of the corrective actions to be taken for a known condition.

B. Lateral thawing shall be at the customer's expense if:

1. The customer's lateral is not electrically conductive and the frozen lateral is not a direct result of a Water Utility disconnect as set forth in sub. A. 1. or;
2. The customer neglected to provide or maintain proper insulation or protection for the lateral according to standard accepted practice, or specific Water Utility instructions on, for example, the required depth of burial needed to prevent freezing, or;
3. The Water Utility advises the customer of the corrective measures to be taken and the customer does not follow the Water Utility's advice. (See § PSC 185.35 (7) for bill adjustment where a Water Utility requests a customer to let water flow to prevent freezing), or;
4. If the Water Utility disconnects for a dangerous condition.

Rule 06-08. Number of Meters on One Water Service Pipe. Each parcel of property shall have only one (1) water service with only one (1) water meter (customer) unless otherwise authorized and approved in writing by the General Manager of the Water Utility, except customers may have a second water meter for "lawn sprinkling" (no sanitary sewer charge) in the same location as the domestic meter. A parcel with more than one building to be served may split a single service from the Water Utility to serve each building, if installed per the State Plumbing Code. Each building must have a meter, and each meter must have a separate exterior curb stop that is accessible to Water Utility personnel.

Owners of multi-unit dwelling units or condominiums must apply, in writing, and must obtain approval from the General Manager for the installation of separate water meters for each housing unit served by a single service pipe.

Rule 06-09. Customer Responsibilities. The Water Utility, absent negligence on its part, shall not assume responsibility for any damages incurred by a customer or property owner arising out of a broken or defective water main or service pipe where the installation thereof was performed in a good and workmanlike manner or from damages arising from insecure boilers, variation in water pressure, or the water hammer from the mains or from the failure of any water fixture.

The Water Utility shall not be responsible for the cost of any water loss or property damage arising out of a broken or defective service pipe or appurtenance thereto where the property owner is responsible for the maintenance thereof.

Each customer shall be responsible for maintaining their premises which receive service in as safe a condition as the nature of the premises shall reasonably permit so as to protect employees of the Water Utility from harm when they enter said premises in the performance of their duties.

Each customer is also responsible for providing the Water Utility with access to their premises as provided in **Rule 05-04**. Water service may be temporarily discontinued (shut off) should a customer fail to comply with this Section.

Rule 06-10. Meters Required. All water services within the Retail Service Area shall be metered. All meters shall be furnished by the Water Utility and shall be installed by or under the supervision of the Water Utility. Only one meter will be installed for each service pipe, unless otherwise approved by the General Manager.

The meter must be installed before the City of Kenosha, Department of City Inspections will issue a certificate of occupancy.

No connection to the service pipe shall be made before the meter.

Submeters shall not be installed, read or maintained by the Water Utility.

Rule 06-11. Water Meters, Remote Registers and Meter Bypasses - How Placed.

- A. Meters shall be placed in the basement where a basement exists. The meter must be placed

CODE OF GENERAL ORDINANCES, 2021 - KENOSHA, WISCONSIN

on the service pipe within twelve inches (12") of the inside wall and between twelve inches (12") and twenty-four inches (24") above the floor. If no basement exists or the service pipe is extended beyond where the service enters the building foot print, the service pipe shall be buried under the concrete floor (no exposed pipe) until it rises to the meter. The service pipe riser to the meter shall be perpendicular to the floor and secured or reinforced to support the meter. The meter shall be so placed as to be easily accessible and shall be kept free from all obstructions so that it may be easily read, maintained and inspected and it shall be protected by the property owner from freezing and other damage.

All meters shall have a valve on both the inlet and outlet side of meter.

All meters of size from five-eighths inch (5/8") through one inch (1") shall be set with the use of a meter horn supplied by the Water Utility. Meter horns shall be furnished upon application for a meter and shall be installed by a licensed plumber. Representative detail drawings are on file at the Water Utility Engineering Office and are available for review upon request. Meters installed in newly constructed single family units shall be a minimum of three-quarter inch (3/4").

All meters one and one-half inch (1-1/2") or larger shall be provided with a bypass connection. The bypass connection shall be teed off the main service pipe before the inlet valve and after the outlet valve which are required at the meter. Representative detail drawings are on file at the Water Utility Engineering Office and are available for review upon request. The size of the bypass connection shall not be less than one normal pipe size less than the meter size. A locking valve, approved by the Utility, shall be installed on the bypass and will be locked by the Water Utility. A meter test plug shall be provided between the outlet side of the meter and outlet valve for three inch (3") and larger meters.

Existing meter bypass connections installed without locking bypass valves shall be allowed to remain in service unless it is discovered that the valve has been tampered with or operated without the consent of the Water Utility, whereby the Water Utility will require the owner to replace the existing valve with a locking bypass valve in the meter bypass connection which shall be locked by the Water Utility.

A remote water meter register is required for all water meters, and shall be attached directly to the outside of the building or structure wall. The remote register shall be approximately four (4') feet above finished ground elevation and located by the Water Utility where it will be free of obstruction and easily accessible.

Wiring from meter to remote register will be exposed on both the interior and exterior of a residential (single family or duplex) building unless the owner, at his/her expense, provides a 1/2" conduit.

Any owner or builder of a new duplex, who receives authorization for two separate meters, shall provide a 1/2" conduit with three, #18 wires from each meter to the remote reader. The remote reader shall be field located and approved by the Water Utility.

Wiring from meter to remote register shall be three, #18 wires in a 1/2" conduit for each meter for commercial and industrial buildings. The remote register or reader shall be field located and the location shall be approved by the Water Utility.

Remote water meter registers shall be installed only by authorized employees of the Water Utility. The Water Utility does not assume responsibility for the defacement or damage of property caused by necessary holes, fastenings or other work required for proper installation.

The remote water meter registers, wiring and other appurtenances required for the installation shall be and remain the property of the Water Utility. The Water Utility shall have the right of access to install, read, remove, test and inspect the meter and installation as a condition of providing water service.

Rule 06-12. Location of Meters, Remote Registers--Not Obstructed. In the event that a meter or remote register is situated in a location that is inaccessible or difficult to access, the Water Utility shall notify the owner of such condition, and if such condition is not remedied in a manner satisfactory to the General Manager within thirty (30) days after receipt of such notice, the water service may be discontinued (shut off) by the Water Utility and remain discontinued (shut off) until such condition is remedied.

Rule 06-13. Meters and Meter Bypasses Not to be Interfered With. Meters and meter bypasses shall be left in the condition and manner as set by the Water Utility and shall not be tampered with by anyone in any manner whatsoever. No meter shall be moved or disturbed without written permission from the General Manager, and then only by a licensed plumber.

In no case shall a service pipe coupling bypass be inserted in the service pipe in place of a meter, except that in case of frozen service pipes or frozen meters. Only a licensed plumber, upon notification to

CODE OF GENERAL ORDINANCES, 2021 - KENOSHA, WISCONSIN

the Water Utility, or the Water Utility will be permitted to make such insertion.

Any person violating this provision will be required, as a condition of future water service, to pay an amount equal to the amount of damage sustained by the Water Utility by reason of loss of, or damage to the meter, and the loss of revenue from the sale of water by reason of inaccurate water usage registration on meter. Diversion of service around the meter, which has not been previously authorized by the Water Utility, may result in a disconnection and refusal of service in accordance with Wisconsin Administrative Code, PSC §185.37.

Rule 06-14. Meter Repairs. All meters, damaged by frost, hot water or causes other than ordinary wear and tear, will be repaired or replaced by the Water Utility and the cost thereof shall be charged to the owner of the property served. All repairs or replacements due to ordinary wear and tear of the meter will be made by the Water Utility at the expense of the Water Utility.

Prior to replacing a meter, the condition and configuration of the service pipe and the valves on both the inlet and outlet sides of the meter will be assessed to determine the potential for future water leaks. In those instances where the piping and/or valves are in poor condition and/or the configuration of the plumbing is such that future water leaks are likely, the owner may be asked to sign a "hold harmless" agreement prior to the replacement of the meter. Plumbing configurations that are in violation of Wisconsin Administrative Code, SPS 381 through 387 (Plumbing) will be referred to City of Kenosha, Department of City Inspections.

Rule 06-15. Meter Pits. If a meter pit must be placed outside of the premises, the owner must request special written permission therefor and construct the pit according to specifications of the Water Utility to obtain water service. Representative detail drawings are on file in the Water Utility Engineering Office and are available for review upon request.

New residential units shall be designed in such a manner that outside meter pits are not required.

In all cases of existing or new meter pits, the owner is responsible to maintain the pit according to specifications of the Water Utility. In the event that a pit does not meet Water Utility specifications, the Water Utility shall notify the owner of such condition, and if such condition is not remedied in a manner satisfactory to the General Manager within thirty (30) days after receipt of such notice, the water service may be discontinued (shut off) by the Water Utility and remain discontinued (shut off) until such condition is remedied.

The meter must be accessible for meter reading and testing at all times and is subject to all other rules governing meters.

Rule 06-16. Failure to Read Meters. Where the Water Utility is unable to read a meter, the fact will be plainly indicated on the bill, and either an estimated bill will be computed or the minimum charge applied. The difference shall be adjusted when the meter is again read, that is, the bill for the succeeding billing period will be computed with the gallons or cubic feet in each block of the rate schedule doubled, and credit will be given on that bill for the amount of the bill paid the preceding period. Only in unusual cases shall more than three consecutive estimated or minimum bills be issued.

Rule 06-17. Testing Meters. Water meters shall be tested in accordance with Wisconsin Administrative Code PSC §185.75.

Rule 06-18. Meters Failing to Register. Water meters failing to register shall be billed in accordance with Wisconsin Administrative Code, PSC §185.34.

Rule 06-19. Collection of Overdue Bills. An amount owed by the customer may be levied as a tax as provided in § 66.0809 of the Wisconsin Statutes.

Rule 06-20. Adjustment of Water Bill. An adjustment of a water bill may only be made in accordance with Wisconsin Administrative Code, PSC §186.35.

Rule 06-21. Disconnection and Refusal of Service. Disconnection and refusal of service shall be in accordance with Wisconsin Administrative Code, PSC §185.37.

CODE OF GENERAL ORDINANCES, 2021 - KENOSHA, WISCONSIN

Rule 06-22. Deferred Payment Agreement. Deferred payment agreements shall be in accordance with Wisconsin Administrative Code, PSC §185.38.

Rule 06-23. Dispute Procedures. Dispute procedures shall be in accordance with Wisconsin Administrative Code PSC §185.39.

Rule 06-24. Breaking Seals and Locks Prohibited. No person shall break any seal or lock upon any meter, meter bypass, remote register, valve, private fire hydrant or other fixtures that may be sealed by the Water Utility.

Rule 06-25. Check Valve or Other Protective Devices. When water service is provided to a hot water boiler or other pressure vessel, a check and relief valve or other protective device shall be installed, as required by Wisconsin Administrative Code, SPS 381 through 387 (Plumbing). The Water Utility may require vacuum breakers, backflow preventers or check valves on any water service if it is found necessary to protect the public water supply, as may be determined by the General Manager.

Rule 06-26. Private Fire Service Pipe. Private fire service pipes may be unmetered or metered as authorized by the General Manager. Fire service pipe meters must be set in accordance with **Rule 06-12** where their use is required by the Water Utility. Representative detail drawings are on file at the Water Utility Engineering Officer and are available for review upon request.

The rates for Private Fire Protection service shall be based on the service pipe size as authorized by the Public Service Commission.

Rule 06-27. Seasonal or Intermittent Use. Charges for seasonal or intermittent use are authorized by the Wisconsin Public Service Commission.

Rule 06-28. Permits for Temporary Water Service. Permits for temporary water service shall be issued and obtained from the City of Kenosha Department of City Inspections. Applicants for a new Building Permit shall also make application for Temporary Water Service Permit. Charges for Temporary Water Service Permits shall be as authorized by the Wisconsin Public Service Commission.

No Occupancy Permit for a building serviced by a water service exceeding two inches (2") in diameter shall be approved until such time as the Water Utility has provided the Plumbing Inspector with written verification that the water service that serves the building has been successfully tested in accordance with Rule 06-36.

Rule 06-29. Discontinuance of Service. Any property owner desiring to discontinue the use of water service must give written notice to the Water Utility of such discontinuance, providing within such notice the location of the relevant premises served and the date water service is to be discontinued. Water service discontinuance policies are in accordance with the Wisconsin Administrative Code, PSC §185.3.

Rule 06-30. Disconnection of Water Service Prior To Razing or Moving Buildings. Prior to razing or moving any building the party to whom a Razing or Moving Permit is issued shall request the Water Utility, in writing, to remove the meter and shall cause the water service to be disconnected and capped at the property line. If the capped water service from the property line to the connection at the water main in the public right-of-way is constructed of lead or galvanized steel, the entire water service shall be abandoned and is not permitted for reuse.

Rule 06-31. To Provide a Program for Protecting the Public Water System from Contamination Due to Backflow of Contaminants Through the Water Service Connection into the Public Water System.

A. Cross-Connection Prohibited. No person may establish or permit to be established or maintain or permit to be maintained any cross-connection. No interconnection shall be established whereby potable water from a private, auxiliary or emergency water supply, other than the public water supply of the Utility, may enter the supply or distribution system of the Utility, unless such private, auxiliary, or emergency water supply and the method of connection and use of such supply shall have been

approved by the Utility and the State of Wisconsin Department of Natural Resources. Cross-connection shall be protected as required in Chapter SPS 382, Wisconsin Administrative Code.

B. Inspections. It shall be the duty of the Utility to cause inspection to be made of all properties serviced by the Utility where cross-connection with the public water system is deemed possible. Residential properties serviced by the Utility shall be inspected on an interval matching the meter replacement schedule. All non-residential properties serviced by the Utility shall be inspected on a 2-year interval. Commercial properties of similar or lesser risk as residential properties may follow the same schedule as residential properties. The Utility shall be responsible for determining the hazard risk and the inspection schedule.

The Utility may, but is not required to, perform the cross-connection inspection of residential and low hazard properties. For nonresidential properties or properties of significant hazard risk, upon notification in writing by the Utility, the property owner must, at their own expense, have the plumbing inspected for cross-connections by a State of Wisconsin Certified Cross-Connection Inspector/Surveyor or by a State of Wisconsin licensed plumber.

The frequency of required inspections and re-inspections, based on potential health hazards involved, may be shortened by the Utility. The Utility shall charge fees as approved by the State of Wisconsin Public Service Commission for on-premises follow-up visits by Utility personnel for re-inspection due to customer non-compliance and for after-hours inspections or re-inspections.

C. Owner Responsibility. The property owner shall be responsible for the protection of the customer's potable water system. Every person owning or occupying a premise receiving municipal water supply shall maintain such municipal water supply free from any cross connection, either by a direct or an indirect nature. The responsibilities include the elimination of, or protection from, all cross connections on their premises. The owner shall, at their own expense, install, maintain and test any and all backflow preventers on their premises in compliance with the Chapter SPS 382.41 Wisconsin Administrative Code and the Utility's Cross Connection Ordinance.

The property owner shall have corrected any malfunction revealed by periodic testing of any backflow preventer on their premises. The property owner shall inform the Utility of any proposed or modified cross connections and also any existing cross connections that are not protected by an approved backflow prevention means. The property owner shall not install a by-pass around any backflow preventer unless there is a backflow preventer of the same type in the by-pass. Property owners who cannot shut down operation for testing of the backflow prevention assembly must supply additional assemblies necessary to allow testing and maintenance to take place. In the event the property owner installs potable water using fixtures, equipment or appurtenances upstream of the backflow preventer, such must have its own approved backflow prevention means.

The property owner is required to follow the protection practices described in the American Water Works Association publication AWWA M-14 titled "Recommended Backflow Prevention and Cross Connection Control", United States Environmental Protection Agency publication titled "Cross Connection Control Manual", Chapters SPS 381-384 Wisconsin Administrative Code, and the Utility's Cross Connection Control Ordinance, unless the Utility requires or authorizes other means of protecting the potable water systems.

Other required or authorized means will be subject to prior approval of the Utility.

D. Right of Entry. Upon presentation of credentials, representatives of the Utility shall have the right of entry at any reasonable time to examine any property served by a connection to the public water system of the Utility for cross-connection. If entry is refused, such representatives may obtain a special inspection warrant under 66.0119, Wis. Stats. Refusing to provide access shall be sufficient cause for the Utility to discontinue water service to the property, as provided under paragraph F of this ordinance.

E. Provision of Requested Information. The Utility may request an owner, lessee, or occupant of property served by a connection to the public water system to furnish the Utility with pertinent information regarding the piping systems on the property. Refusing to provide requested information shall

be sufficient cause for the Utility to discontinue water service to the property, as provided under paragraph Subsection F. of this ordinance.

F. Authority to Discontinue Service. The Utility is hereby authorized and directed to discontinue water service to any property wherein any connection in violation of this section exists and to take such other precautionary measures deemed necessary to eliminate any danger of contamination of the public water system. Water service shall be discontinued if the means of backflow prevention required by the Utility is not installed, tested, maintained, and repaired in compliance with this ordinance and Wisconsin Administrative Code NR 811 or if it is found that the means of backflow prevention required by this ordinance has been removed, bypassed or information requested in Section E. is not provided. Water service shall be discontinued only after reasonable notice and opportunity for hearing under Ch. 68 Wis. Stats., except as provided in Subsection G. of this section. Water service to such property shall not be restored until the unprotected cross-connection has been eliminated or requested information is not provided.

G. Emergency Discontinuance of Service. If it is determined by the Utility that an unprotected cross-connection or an emergency endangers public health, safety, or welfare and requires immediate action, service may be immediately discontinued. A written notice to the effect must be delivered to the customer premises. The owner, lessee, or occupant shall have an opportunity for hearing under Ch. 68 Wis. Stats., within 10 days of such emergency discontinuance. Such hearing shall be before the Board of Water Commissioners and shall conform to all existing due process requirements.

H. Reconnection of Service. Water service to any property discontinued under the provisions of this ordinance shall not be restored until the cross-connection has been eliminated or a backflow prevention device is approved by the Utility has been installed in compliance with the provisions of this section. The Utility shall charge fees as approved by the State of Wisconsin Public Service Commission for the reconnection of the water service.

I. Additional Protection. In the case of premises having (a) internal cross-connection that cannot be permanently corrected or controlled, or (b) intricate plumbing and piping arrangements or where entry to all portions of the premises is not readily accessible for inspection purposes, making it impracticable or impossible to ascertain whether or not dangerous cross-connections exist, the public water system shall be protected against backflow from the premises by installing an approved backflow preventer in the service line. In the case of any premises where there is any material dangerous to health that is handled in such a manner that, in the opinion of the Utility, could create an actual or potential hazard to the public water system, the public water system shall be protected by an approved air-gap separation or an approved reduced-pressure principle backflow preventer. Examples of premises where these conditions will exist include sewage treatment plants, hospitals, mortuaries, plating plants, and car wash establishments. In the case of any premises where, in the opinion of the Utility, an undue health threat is posed because of the presence of toxic substances, the Utility may require an approved air gap at the service connection to protect the public water system. This requirement will be at the discretion of the Utility.

Rule 06-32. Fire Hydrants. No person, except an employee of the Water Utility, Public Works Department or Fire Department, in the course of their employment, or person obtaining a permit from the Water Utility, shall open and take water from a Water Utility owned fire hydrant or in any way interfere with, injure, break, or deface any fire hydrant belonging to the Water Utility. No building, structure, tree, pole, post, sign, or any other obstruction shall be placed, located or maintained within a five (5') foot radius of any fire hydrant connected to the Water Utility water supply system.

Any unauthorized person taking water from a fire hydrant shall pay to the Water Utility a Hydrant Permit fee and water usage charge as payment for the water diverted from the fire hydrant in addition to any applicable civil forfeitures resulting from prosecution and conviction for a violation of this Chapter.

Fire Hydrant Permit fees are authorized by the Wisconsin Public Service Commission.

Rule 06-33. Fire Hydrant Maintenance. Private fire hydrant maintenance may be performed by Water Utility employees upon a signed agreement between the Water Utility and property owner. Charges for private fire hydrant maintenance shall be established by the Water Utility.

Rule 06-34. Fire Protection. The Water Utility, as a public service, may install and maintain fire hydrants to be used for Public Fire Protection. The fire hydrants shall be installed in accordance with the National Board of Fire Underwriters recommendations. However, the Water Utility does not assume liability for any failure to act in this regard as the performance of such service is not guaranteed within any particular time frame or as to any particular location.

Rule 06-35. Testing of Water. The Wisconsin Department of Natural Resources has approved and authorized the Water Production Laboratory of the Water Utility to test water to determine if it is safe for domestic purposes.

Any water connection larger than two (2") inches shall be flushed by the installer and tested by the Water Utility laboratory and be certified with two consecutive bacteriologically safe samples at least twenty-four (24) hours apart prior to use for any purpose. A water line pressure test shall be made only after bacteriologically safe samples have been obtained.

Preparation for flushing and testing shall consist of providing a flushing assembly at the end of the installed line before any other piping is connected. The flushing assembly shall consist of a two (2") inch minimum connection to the end of the line, a three-quarter (3/4") inch female pipe tee for a test faucet, a test faucet and necessary hose to discharge the flushing water in to a drain. The size of the hose shall be one and one-half (1-1/2") inches for water main sizes smaller than eight (8") inches and hose lengths two hundred (200') feet or less. All others require hoses two and one half (2-1/2") inches in diameter.

Flushing shall proceed only upon approval and under the supervision of the Water Utility. All samples for newly constructed services or water mains shall be taken by Water Utility personnel. Metering of flushing water is required. Meters can be obtained at the Utility Business Office.

Flushing water may only be turned off upon notification by the Water Utility that the installation has been determined to be bacteriologically safe.

32.07 RULES AND REGULATIONS GOVERNING THE SEWERAGE SYSTEM

Rule 07-01. Sewer Inspection Permit Required. A Sewer Inspection Permit shall be obtained from the Department of City Inspections or the Water Utility before any extension is made to a sanitary sewer main or lateral. Any work on sanitary sewers within the street right-of-way or any Water Utility easement shall be done according to Water Utility specifications and inspected by the Water Utility Engineering Division.

Rule 07-02. Sewer Lateral Charges. Owners shall be responsible, where the sewer main extension has been approved by the Water Utility through a developer's agreement for the sanitary sewer lateral installation costs from the main to the property line.

The initial sanitary sewer lateral(s), not installed as part of a developer's agreement or an assessable utility extension, will be installed from the main through to the property line by the Water Utility, for which there will be charges as approved by Board.

Rule 07-03. Sewer Lateral Specifications. Sanitary sewer lateral from the sewer main to the property line shall be a minimum of four inch (4") for residential properties and a minimum of six inch (6") for non-residential properties, to include PVC pipe with rubber gaskets or solvent cemented joints. If a tee or wye is not available for connection, a saddle of the proper size shall be used. Saddle shall be installed with sealant and stainless steel straps as recommended by manufacturer. Hole cutter or sabre saw shall be used to cut PVC sewer pipe.

Rule 07-04. Responsibility for Sanitary Sewer Pipes, Appurtenances, and Connections. The property owner is responsible for the installation, maintenance, cleaning, repair and replacement of the entire sanitary sewer lateral from the building to the Water Utility's sanitary sewer located in an easement or in the public right-of-way.

In the event it becomes necessary to repair or replace that portion of the sanitary sewer lateral that lies underneath the public right-of-way, the Water Utility will make the necessary repair or replacement at its initial cost upon the property owner signing an agreement that the property owner will pay the costs of the necessary sanitary sewer lateral repair and replacement and excavation and repair of the public right-of-way in the event such work is necessitated because of damage or blockage to the sanitary sewer lateral that was caused by property owner, or occurred during the homeowner's, or the homeowner's contractor's maintenance or cleaning of the sanitary sewer lateral or for other causes attributable to the homeowner or the homeowner's contractors.

In the event any repair or replacement of the sanitary sewer lateral outside of the public right-of-way is required of the owner, the owner, at their expense, must make the repair or replacement within thirty (30) days after receiving written notice from the Water Utility that repair or replacement is required. If the necessary repair or replacement is not completed by the owner within said thirty (30) days, or if the condition requiring repair or replacement is of such a nature as to cause a danger to persons or property, the Water Utility may make the necessary repair or replacement and charge the cost to the property owner, and specially assess the property served.

Rule 07-05. Customer Responsibility. The Water Utility shall not assume responsibility for any damages incurred by a customer or property owner arising out of a broken or defective sanitary sewer main where the installation thereof was performed in a good and workmanlike manner.

The Water Utility shall not be responsible for the cost of any property damage arising out of a broken or defective service pipe or appurtenance thereto where the property owner is responsible for the maintenance thereof.

Each customer shall be responsible for maintaining their premises which receives service in as safe a condition as the nature of the premises shall reasonably permit so as to protect employees of the Water Utility from harm when they enter said premises in the performance of their duties.

The customer is responsible for providing the Water Utility with access to their premises so that employees of the Water Utility may read meters and make other inspections as authorized or required by the Board or this Chapter. Water service may be temporarily discontinued (shut off) should a customer fail to comply with this Rule.

Rule 07-06. Required Building Connections to Sanitary Sewer. For each parcel of property, there shall be one sanitary sewer lateral connection, unless otherwise authorized and approved in writing by the General Manager. To assure preservation of the public health, comfort, and safety, it is required that any building used for human habitation or intended for human habitation and located adjacent to a sanitary sewer main or in a block through which such main extends, be connected with such sanitary sewer main by means of individual connections or private interceptor mains. If any person fails to comply for more than one hundred eighty (180) days after notice in writing, the Water Utility may impose a penalty or may cause connection to be made, and the expense thereof shall be assessed as a special tax against the property. The owner may, within thirty (30) days after the completion of the work, file a written request with the City Clerk asking that the special assessment be payable in ten (10) equal annual installments. The amount of each installment shall be equal to one-tenth (1/10th) of the total special assessment, plus interest at a rate determined by the Board. Special assessments shall be placed on the real estate tax roll and collected in the manner provided by law.

Rule 07-07. Sewerage Service Charges.

Rule 07-07(01). Cost of Service. Sewerage Service Charges are composed of operation,

maintenance, replacement, capital and debt costs. These costs of service are distributed to wastewater volume, BOD, suspended solids, phosphorus, and customer service.

Customer service costs associated with water meter costs, water meter reading, billing, and collecting bills are assessed equally to all sewer customers as a fixed charge.

New connections will be allowed to connect to the system if there is available capacity in the existing wastewater collection and treatment facilities. The Utility has the right to reject connections of users or other municipalities if capacity of the system is not adequate.

Rule 07-07(02). Replacement Fund (DNR). Replacement Fund costs are determined by annual depreciation cost to equipment with a life of 20 years or less. These allocations are then distributed to volume, BOD, suspended solids, and phosphorus. This is a restricted fund used for replacement of existing equipment.

Rule 07-07(03). Capital Costs. Capital expenses are allocated to the wastewater parameters based upon their relation to the parameters. Outlying community customers are not charged for any collection system capital expenditures. A return on investment is charged to outlying communities to collect revenues to reimburse the Utility for capital expenses incurred in the past for older wastewater treatment facilities and interceptors that are still in use.

Rule 07-07(04). Operation and Maintenance Costs. Operation and maintenance costs are allocated to wastewater parameters and customer services. For the outlying communities, the unit costs for volume are adjusted by subtracting out the cost of collection system sewer main and lateral maintenance. The outlying communities will pay for a portion of the sewer maintenance and treatment of infiltration/inflow that is attributable to their usage of the interceptor sewer system.

Rule 07-07(05). Rates and Fees. The Board shall establish, adopt, and from time to time modify rates and fees. The Board shall develop a sewerage service charge system that will:

1. Meet Department of Natural Resources' requirements as may be required.
2. Develop rates that will allow the Water Utility to generate revenue to pay expenses, cover debt service, and receive an adequate return on investments.
3. Establish fair and equitable rates for the City of Kenosha retail customers, outlying municipalities, waste haulers and any other customers receiving service from the Water Utility.

All rates and fees for sewer service shall be adopted by the Board and shall relate to the following categories:

A. Category A Retail Charges. Category A Retail is defined as City of Kenosha customer with normal domestic strength wastewater having BOD concentrations of no greater than 200 mg/l, suspended solids no greater than 250 mg/l, phosphorus no greater than 5.0 mg/l.

1. The service charge for Category A Retail customers shall be the fixed charge plus volume charge. The service charge for Category A Retail dischargers discharging to the wastewater collection facilities and being served by the Water Utility with water metered service shall be based on the volume of water used, as measured by the Water Utility water meter upon the premises receiving water service from the Water Utility, plus a fixed charge.
2. Industrial dischargers will be assessed an additional charge for the purpose of defraying the cost of the Wastewater Discharge Permit and pretreatment program.
3. The service charge for Category A Retail residential dischargers discharging to the wastewater collection facilities and receiving part or all of their water supply from sources other than the Water Utility, shall be based upon the estimated volume of wastewater discharged to the wastewater collection facilities where there is no meter measuring the total water supply used. Where desired, the owners or occupiers of such property shall install sewage meters, at their cost and expense. Where such a meter has been installed, the service charge shall be based upon the volume of wastewater discharged,

plus a fixed charge. Commercial or industrial dischargers discharging to the wastewater collection facilities and receiving part or all of their water supply from sources other than the Water Utility, shall be required to install water or sewage meters for billing calculation purposes. The cost of the meters and installation shall be paid by the customer. Testing of meters to ensure the proper operation and accuracy shall be performed as required by the Water Utility.

4. Where a significant amount of metered water does not reach the wastewater collection facilities due to process water that is discharged into the storm sewer system or ground watering, etc., the discharger may, at their own cost and expense, install a second meter which would monitor the flow of such water. Requests for a second meter must be made, in writing, and approved by the General Manager of the Water Utility. Upon approval and verification by the Water Utility of the separated piping systems, the second meter will be installed.

5. The Water Utility may determine a sprinkling credit, which is a reduction in the Sewerage Service Charge, to be given for summer water consumption in excess of normal winter consumption. This credit is given based on the average usage during the winter season subtracted from the actual usage during the summer season. There is a minimum usage of 1,000 cubic feet per month for summer consumption. This provision applies only to retail residential customers within the City of Kenosha.

B. Category B Retail Charges. Category B Retail is defined as City of Kenosha customers having wastewater concentrations of BOD greater than 200 mg/l, suspended solids greater than 250 mg/l, or phosphorus greater than 5.0 mg/l.

Dischargers whose wastewater exceeds the concentrations for any one of these parameters shall be in Category B Retail. The service charge for Category B Retail wastewater shall be the fixed charge and volume charge as established in Category A Retail, plus a unit charge for BOD greater than 200 mg/l, suspended solids greater than 250 mg/l, or phosphorus greater than 5.0 mg/l. Category B Retail service charges for volume, BOD, suspended solids and phosphorus shall be computed in accordance with the formula presented below:

$C = F + (V \times CV) + 0.00624 V [(B \times CB) + (S \times CS) + (P \times CP)]$ where:

C is the Charge to sewer user for collection and treatment of wastewater;

F is the Fixed charge per billing period;

B is the Concentration of excess BOD in mg/l in the wastewater (concentration minus 200 mg/l equals B);

S is the Concentration of excess suspended solids in mg/l of wastewater (concentration minus 250 mg/l equals S);

P is the Concentration of excess phosphorus in mg/l of wastewater (concentration minus 5.0 mg/l equals P);

V is the Wastewater volume in 100 cubic feet for the billing period; **CV** is the Cost per 100 cubic feet;

CB is the Cost per pound of BOD;

CS is the Cost per pound of suspended solids;

CP is the Cost per pound of phosphorus;

0.00624 equals Conversion factor.

C. Wholesale/Municipal Metered Charges. Wholesale/Municipal Metered Service Charges for outlying communities are established for customers flowing into master sewer meters. The charges for this class of customer shall be determined by actual readings and monitored loadings from the master meter. Fixed charges and/or sampling charges shall be calculated based on actual costs for service, including, but not limited to, metering, monitoring, testing, billing and administration.

D. Wholesale/Municipal Unmetered Charges. Wholesale/Municipal Unmetered Service Charges for outlying communities are established for customers not flowing into master sewer meters. Sewer service charges for outlying community's customers not having master sewer meters shall be based on average sewer metered flows and loadings, from their respective village, town, or district, less any industrial/commercial flows and loadings, divided by the number of nonindustrial/commercial customers connected to the metered system. Fixed charges shall be calculated based on actual costs for

service.

Industrial dischargers will be assessed an additional charge for the purpose of defraying the cost of the Wastewater Discharge Permit and Pretreatment Program.

Rule 07-07(06). Billing Procedure for Service Charges.

A. Sewerage Service Charge Billing Period. Service charges shall be billed pursuant to a schedule recommended by the General Manager of the Water Utility and approved by the Board.

B. Payment of Service Charges. Sewerage service charges shall be payable twenty (20) days after the billing date, at the Water Utility Business Office or authorized payment station.

C. Penalties. A late payment charge of one (1%) percent per month will be added to bills not paid within 20 days of issuance. This late payment charge will be applied to the total balance for sewerage service, including late payment charges.

Rule 07-07(07). Service Charge for Haulers. No hauler in the business of collecting and disposing of septic tank sludge, holding tank sewage, leachate or other wastes shall discharge such material to the wastewater collection facilities unless a Wastewater Discharge Permit therefor has been first obtained from the Water Utility. "Hauler Dumping Rates" for service charges shall apply to all haulers.

Rule 07-07(08). Charges to Industrial Dischargers in the Wastewater Discharge Permit Program. In addition to service charges, industrial discharges in the Wastewater Discharge Permit Program shall pay an annual charge which is based upon the volume of wastewater discharged per year to the wastewater collection facilities. Charges are also assessed to pay for costs incurred by the Water Utility for the sampling and analysis of each of the priority pollutants and/or other regulated pollutants.

Rule 07-07(09). Laboratory Testing Charges. Laboratory fees for testing metals, oil and grease, PH, B.O.D., suspended solids, phosphorous, leachate sampling and other testing shall be based on time, material and overhead.

Rule 07-07(10). Charge For Unlawful Storm Water Discharge. In the event the Water Utility determines that storm (rain) water from a downspout, sump pump, parking lot, or any other cause located on property receiving sanitary sewer service is discharged in violation of Rule 08-02(02) of the Code of General Ordinances, the Water Utility may assess a charge to cover the cost of treatment, administration and other associated costs. In addition, penalties under Rule 10 Penalties may apply.

The owner or occupant of the violating property will be provided with a written notice of the violation and given 30 days to permanently disconnect the unlawful connection prior to the imposition of the charge.

The charge, based on the estimated volume of storm (rain) water entering the sanitary sewer system plus administrative cost, will be added to the customer's service bill. This charge is in addition to all other remedies and ordinance enforcement measures provided for in this Chapter.

32.08 WASTEWATER DISCHARGE REGULATIONS

Rule 08-01. General. These regulations set forth uniform requirements for dischargers discharging into the wastewater collection facilities of the Water Utility and enables said Water Utility to comply with the Clean Water Act, as amended, 33 U.S.C. 1251, et seq. and the Pretreatment Regulations, 40 CFR Part 403. This Section also allows the POTW to operate pursuant to legal authority enforceable in Federal, State, and local courts, which authorizes or enables the POTW to apply and to enforce the requirements of Sections 307(b) and (c), and 402(b)(8) of the Act and any regulations as hereafter provided for. The objectives of this Section are as follows:

B. To prevent the introduction of discharges into the wastewater collection and treatment facilities which could cause injury thereto, not amenable to removal, or could contaminate sludge;

C. To provide for the equitable distribution of the costs and expenses of the system and of operating an industrial wastewater pretreatment program through the granting of Wastewater Discharge Permits.

D. To provide for the regulation and monitoring of dischargers discharging into the wastewater collection facilities through the issuance of permits and enforcement of general regulations.

These regulations apply to all wastewater discharged into the Water Utility's wastewater collection system and/or treated at the Water Utility's wastewater treatment facilities.

Rule 08-02. Discharge to the Wastewater Collection Facilities.

Rule 08-02(01). Unpolluted Waters Prohibited in Sanitary Sewers. No person shall discharge or cause to be discharged any unpolluted waters into the wastewater collection facilities. Unpolluted waters may only be discharged into storm sewers and such other outlets as permitted by law.

Rule 08-02(02). Downspouts and Sump Pumps Discharge Prohibited. No downspout or sump pump of any house, building, structure, or outlet of any cistern or drain shall be connected to or discharged to the wastewater collection facilities. In the event of such a connection, the Water Utility shall provide the owner or occupier of the violating property with a written notice to permanently disconnect the unlawful connection, within Thirty (30) days. It shall be unlawful for any person to fail to promptly comply with such order, unless an extension of time has been requested from and granted by the Water Utility prior to the date specified in an order to disconnect. (Charges for unlawful storm water discharge – See Rule 07-07 (10).)

Rule 08-02(03). Wastewater Prohibited in Storm Water Collection Facilities. No person shall discharge, or cause to be discharged, any wastewater into the storm water collection facilities, unless specifically authorized to do so under the terms of a specific WPDES Permit.

Rule 08-02(04). Prohibited Wastewater. No person shall discharge or cause to be discharged any of the following, measured at the point of discharge, into the wastewater collection facilities.

A. Gasoline, benzene, naphtha, fuel oil, or other flammable or explosive liquids, solids or gases, which by reason of their nature or quantity may be sufficient, either alone or by interaction with other substances to create a fire or explosion hazard or be injurious to the POTW. Other elements and compounds are included, but are not limited to wastestreams with a closed cup flashpoint of less than 140 degrees F or 60 degrees C using the test methods specified in 40 CFR 261.21.

B. Wastewater containing nonconventional pollutants; or solids, liquids, or gases of any property which, in sufficient quantity, either singly or by interaction with other wastes, may injure the system or contaminate the sludge, or cause air pollution above allowable levels.

C. Wastewater discharged with a pH of less than 5.5 or greater than 10.0 or which may cause corrosive structural damage to the wastewater collection or treatment facilities.

D. Solids which cannot penetrate a Tyler designation 20 mesh screen or viscous substances in quantities which may injure the system or contaminate the sludge.

E. Heat in amounts which will inhibit biological activity in the POTW resulting in interference, but in no case heat in such quantities that the temperature at the POTW exceeds 104 degrees Fahrenheit (40 degrees Celsius).

F. Wastewater containing more than 100 mg/l of petroleum oil, nonbiodegradable cutting oils, or products of mineral oil origin, or otherwise in amounts that will cause interference or pass through.

CODE OF GENERAL ORDINANCES, 2021 - KENOSHA, WISCONSIN

G. Garbage that has not been shredded so as to comply with **Rule 08-02(04)D**. (Garbage grinders may be connected to sanitary sewers from homes, hotels, institutions, restaurants, hospitals, catering establishments, or similar places where garbage originates from the preparation of food.)

H. Wastewater containing chromium, copper, zinc, and other nonconventional and priority pollutants to such degree that they are in concentrations exceeding levels specified within this Section or within applicable Federal and State laws, rules and regulations. Categorically regulated wastestreams shall be measured at the point of discharge from the regulated process, a discharge from a pretreatment process, or at the point of discharge to the wastewater collection facilities when the use of the combined wastestream formula has been approved.

I. The following substances in excess of the limit below provided:

Parameter	Consecutive 4 Day Average Limit (mg/L)	Daily Maximum Limit (mg/L)
Cadmium	1	1.75
Chromium (Total)*	10	15
Copper	1.5	2.63
Lead	10	15
Mercury	0.001	0.00175
Nickel	3	5.25
Silver	3	5.25
Zinc	10	15
Cyanide	0.96	1.7

*Hexavalent chrome shall be reduced to trivalent chrome before discharge to the wastewater collection facilities or be eliminated from the wastewater stream.

Should National Categorical Pretreatment Standards (NCPS) provide for more stringent limitations, the NCPS shall prevail.

J. Wastewater containing substances which are not amenable to treatment or reduction by the wastewater treatment processes employed by the wastewater treatment facility, or which are amenable to treatment only to such degree that the wastewater treatment facility effluent cannot meet the requirements of the Federal and State laws, rules, and regulations.

K. Wastewater which, by interaction with other wastewater, forms and releases pollutants that result in the presence of toxic gases, vapors, fumes, or suspended solids which may injure the system or enter the POTW in a quantity that may adversely affect worker health or contaminate the sludge.

L. Pollutants, including oxygen demanding pollutants (BOD, etc.) released in a discharge at a flow rate and/or pollutant concentration that will cause interference with the POTW.

M. Substances which exert or cause:

1. A volume or concentration of wastewater consisting of slugs in sufficient quantities to injure the system or contaminate the sludge.
2. Concentrations of inert suspended solids, or inert dissolved solids, sufficient to injure the system or contaminate the sludge.

N. No person shall introduce or cause to be introduced into the POTW any pollutant or wastewater which pass through or interfere with the operation or performance of the POTW or sanitary sewer.

Rule 08-02(05). Dilution of Discharge Prohibited. No person discharging into the wastewater collection facilities shall increase the use of potable or process water or mix separate wastewaters for the purpose of diluting prohibited wastewater as a partial or complete substitute for pretreatment or to otherwise avoid compliance with or circumvent this Section.

Rule 08-02(06). Notice of Accidental Discharge of Prohibited Wastewater. Any person who does not hold a Wastewater Discharge Permit who discharges or causes to be discharged prohibited wastewater into the wastewater collection facilities shall immediately orally notify the Water Utility thereof. Such notice shall include the date, time, place, and cause of such discharge, the nature, volume, and concentration of such discharge and any corrective action taken. The oral notice must be reduced to writing and submitted to the Water Utility within ten (10) days of an accidental discharge.

Rule 08-03. Wastewater Discharge Permits.

Rule 08-03(01). Dischargers Required to Obtain a Permit. The following Dischargers shall be required to obtain a Wastewater Discharge Permit prior to and as a condition of any wastewater discharge into the wastewater collection facilities:

- A. Industrial Dischargers currently discharging to the wastewater collection facilities.
- B. Industrial Dischargers not currently discharging to the wastewater collection facilities who intend to discharge within ninety (90) days.
- C. Haulers.
- D. Municipalities.

Rule 08-03 (02). Procedures for Application. Applications for Wastewater Discharge Permits shall be made on Water Utility supplied forms. It shall be unlawful for any person to intentionally file an incomplete or inaccurate application. A Wastewater Discharge Permit will not be processed or issued until a complete and accurate application is filed. The application for a Wastewater Discharge Permit must be signed by an authorized representative of the industrial user, municipality or hauler, and must contain the following information prior to being processed:

- A. The name, address and location of the industrial discharger, hauler or municipality and the location of the point of discharge if different from the business address.
- B. The SIC number of the facility.
- C. The probable constituents and characteristics of wastewater that will be discharged.
- D. The expected time and duration of discharges.
- E. The expected average daily wastewater discharge rates, in gallons per day, including seasonal variations, if any.
- F. Site plans, floor plans, mechanical and plumbing plans, and details which show all sanitary sewers, sanitary sewer connections, inspection manholes, sampling chambers, and appurtenances by size, location and elevation.
- G. General description of activities, facilities, and plant processes on the premises, including all materials that may be discharged.
- H. A listing of each product produced by type, expected quantity, process or processes, and anticipated rate of production.
- I. The type and quantity of raw materials utilized, which may be discharged.
- J. Whether or not the Facility will be in compliance with this Section on a consistent basis.

Rule 08-03(03). Amendments to Applications. An industrial discharger, municipality, or hauler, must submit an amended application for a Wastewater Discharge Permit within thirty (30) days following any material change in the information required and previously submitted on an application form, and thirty (30) days prior to the following:

- A. Change in the characteristics and constituents of wastewater,
- B. Change in the volume of wastewater discharged by twenty percent (20%) or more, or
- C. Change in the operations or processes utilized by the discharger. An amended application will

be processed the same as if it were an original application. This rule does not apply to temporary variations in production schedules.

Rule 08-03(04). Insufficient Information. Where an application for a Wastewater Discharge Permit contains insufficient or inaccurate information, the Water Utility may require more complete and accurate information. Applicants shall be provided thirty (30) days from the date of receipt of written notice of an incomplete or inaccurate application in which to furnish more complete or accurate information.

Rule 08-03(05). Permit Approval. Ninety (90) days after a fully completed and accurate application is submitted for a Wastewater Discharge Permit, such permit shall be issued in accordance with the provisions of this Section, which will specify wastewater which is totally prohibited, place limits on the constituents and characteristics of wastewater, and provide for the pretreatment of certain wastewater prior to its discharge to the wastewater collection facilities. Wastewater Discharge Permits are granted by the Board.

Rule 08-03(06). Permit Terms, Conditions and Limitations. The following terms, conditions, and limitations shall be specified in Wastewater Discharge Permits:

A. Effluent limitations based on prohibited discharge standards, categorical pretreatment standards, local limits and state and local law.

B. Limitations on the average and maximum rate and time of discharge and/or requirements for flow regulation and equalization.

C. Requirements for inspection and sampling. Cost incurred by the Water Utility for sample collection and analysis shall be billed to the discharger.

D. Special conditions imposed by the Water Utility under particular circumstances, including sampling locations, frequency of sampling and monitoring, the number and types of analytical tests, reporting schedule, and special technical reports or discharge reports. The special conditions imposed shall be reasonable and necessary to carry out the objectives of this Section. In each case, at the discharger's written request, the Water Utility may provide to the discharger a full and complete explanation of the reason for the special condition(s).

E. Requirements for reporting and action plans in the event of an accidental discharge of prohibited wastewater. Dischargers which have a potential for an accidental discharge of prohibited wastewater shall be required to develop a written plan designed to prevent accidental discharges of prohibited wastewater, and in the event of such accidental discharge, to mitigate potential damages which could be caused thereby. Such plan shall include a provision that dischargers place signs in conspicuous places on their premises advising officers, employees and agents thereof of the procedure to be utilized to report a discharge of prohibited wastewater to the Water Utility.

F. Requirements for pretreatment. Where pretreatment is required, the discharger shall submit a plan therefor to the Water Utility. Such plan may not be implemented until approved by the State of Wisconsin and the Water Utility. Effluent limitations will be based on applicable Federal and State pretreatment standards and this Chapter. It shall be unlawful for a discharger to fail to obey an order for pretreatment for any phase of the implementation of pretreatment. Pretreatment shall be at the sole cost and expense of the discharger.

G. Provisions for self-monitoring, sampling, reporting, notification, and record keeping requirements, including an identification of the pollutants to be monitored, sampling location, sampling frequency, and sample type, based on Federal and State laws, rules and regulations and this Chapter. Installation, operation, and maintenance of the sampling facilities shall be at the cost and expense of the discharger and shall be subject to the approval of the Water Utility. Access to sampling sites, processes that discharge wastewater, pretreatment facilities and wastewater self-monitoring records shall be granted to the Water Utility and its authorized representatives.

H. Requirements to control slug discharges, if determined by the POTW to be necessary. If the POTW determines that a slug control plan is needed, the industrial user must develop a plan with the following elements as deemed necessary by the POTW:

1. A description of discharge practices, including non-routine batch discharges;
2. A description of stored chemicals;
3. Procedures for immediately notifying the POTW of slug discharges, including any discharge that

CODE OF GENERAL ORDINANCES, 2021 - KENOSHA, WISCONSIN

would violate a prohibition in Rule 08-02(04), with procedures for a subsequent written notification within 5 days;

4. Any procedures deemed necessary by the POTW to;

- a. Prevent accidental spills;
- b. Inspect and maintain storage areas;
- c. Handle and transfer materials;
- d. Control loading and unloading operations;
- e. Control plant site run-off; and
- f. Train workers.

5. Any procedures deemed necessary by the POTW for building containment structures or equipment;

6. Any procedures deemed necessary by the POTW to contain toxic organic pollutants, including solvents;

7. Any procedures and equipment deemed necessary by the POTW for emergency response; and

8. Any practices deemed necessary by the POTW to limit the damage suffered by the treatment plant or the environment after a slug discharge.

I. Provisions of discharge by haulers. The permit will identify each vehicle and the license number thereof which will discharge into the wastewater collection facilities. Permits shall be nonassignable and nontransferable, except in the case of replacement of a vehicle for which a permit has been issued. The Water Utility may require a bond to guarantee payment of all fees and charges. The time and place of discharge into the wastewater collection facilities will be designated by the Water Utility. The Water Utility may impose such conditions as it deems necessary on any permit granted.

Haulers must carry public liability and motor vehicle insurance in an amount no less than One Million Dollars (\$1,000,000) covering loss through death, injury and property damage caused in any way or manner by an action, or omission, of a hauler or the employees or agents thereof. A Certificate of Insurance must be furnished to the Water Utility with the application.

Haulers shall post a bond for Five Thousand Dollars (\$5,000) to indemnify and hold harmless the Water Utility against injury to the system, contamination of the sludge, and costs associated with the correction of upsets in process at the wastewater treatment facility. Permit holders may not discharge prohibited wastewater into the system unless their permit so authorizes, and then only to the extent permitted.

Haulers shall pay a service charge as determined by the concentration of the waste pursuant to Rule 07-07(05) of this Chapter, or as determined by agreement with the Water Utility. All trucked or hauled wastewater must be discharged at the point(s) designated by the Water Utility.

J. A statement that dischargers discharging on the effective date of this rule shall comply with said Section where it is stricter than Federal or State laws, or regulations, within fifteen (15) days after the effective date of said Section. If compliance with Section 32.08 is not met within the allotted fifteen (15) days, stepped enforcement actions will be initiated.

K. A statement of applicable civil and criminal penalties for violation of this Chapter, pretreatment standards and requirements, and any applicable compliance schedule.

L. Compliance by existing industrial sources with categorical pretreatment standards shall be within three (3) years of the date the standard is effective unless a shorter compliance time is otherwise specified. Existing sources which become industrial users subsequent to promulgation of an applicable categorical pretreatment standard shall be considered existing industrial users.

M. New sources shall install and have in operating condition, and shall "start-up" all pollution control equipment required to meet applicable pretreatment standards before beginning to discharge. Within the shortest feasible time (not to exceed 90 days), new sources must meet all applicable pretreatment standards.

Rule 08-03(07). Equivalent Limits. When the limits in a categorical pretreatment standard are expressed only in terms of mass of pollutant per unit of production, the POTW may convert the limits to equivalent limits expressed either as mass of pollutant discharged per day or effluent concentration.

The POTW shall calculate equivalent mass-per-day limitations by multiplying the limits in the

CODE OF GENERAL ORDINANCES, 2021 - KENOSHA, WISCONSIN

standard by the industrial user's average rate of production. This average rate of production shall be based upon a reasonable measure of the industrial user's actual long-term daily production, such as the average daily production during a representative year. New sources shall use projected production in place of actual production.

Any industrial user operating under a control mechanism incorporating equivalent mass or concentration limits shall notify the POTW within two (2) business days after the user has a reasonable basis to know that the production level will significantly change.

Rule 08-03(08). Permit Duration. All Wastewater Discharge Permits shall be issued for four (4) years, or as determined by the Board, subject to conditions of this Section.

Rule 08-03(09). Limitations on Permit Assignment and Transfer. A Wastewater Discharge Permit is issued to a specific industrial discharger, municipality, or hauler for a specific operation and is not valid for operations not described in the application, is not assignable to another discharger, or transferable to any other location without prior notification and approval from the Water Utility.

Rule 08-03(10). Permit Amendments by Issuer. The Water Utility may amend any Wastewater Discharge Permit issued to a discharger subject to the discharger being given an opportunity to be heard, for the purpose of correcting any errors or omissions made by the Water Utility and to incorporate revised limitations on prohibited wastewater required by law. A compliance schedule shall be issued if an industry cannot meet any new or modified requirements on their effective date, unless prohibited by Federal or State law, rule or regulation.

Rule 08-03(11). Extensions of Permit Time Schedules. Whenever any industrial discharger, municipality, or hauler believes that any time schedule contained in a Wastewater Discharge Permit is unreasonable under the circumstances, such discharger may request, in writing, an extension of time to meet such schedule prior to the expiration of any such time limit. Time extensions may be given after the fact, but the discharger is subject to the penalties herein provided for failure to meet such time schedule.

Rule 08-03(12). Opportunity for Hearing Relative to Permit Conditions and Limitations. Any discharger, within thirty (30) days of the granting of a Wastewater Discharge Permit, may file with the Water Utility a request to be heard relative to the application of any permit conditions and limitations. An opportunity to be heard will be provided before the General Manager of the Water Utility within ten (10) days of the receipt thereby of a request for hearing.

Rule 08-04. Reporting and Monitoring Requirements for Holders of Wastewater Discharge Permits.

Rule 08-04(01). NCPS Incorporated by Reference. The NCPS, and all amendments which may be made thereto, are incorporated herein by reference.

Rule 08-04(02). Application of Rule 08-04. Rule 08-04 is applicable to all holders of Wastewater Discharge Permits where NCPS are applicable.

Rule 08-04(03). Notice to Holders of Wastewater Discharge Permits. Where applicable, the Water Utility shall provide written notification to all holders of Wastewater Discharge Permits, that NCPS are applicable, as follows:

A. At the time of granting a Wastewater Discharge Permit, such notice will be provided within such permit, and limitations provided for by NCPS will be a term and condition of such permit.

B. At such time as the Water Utility is aware of new NCPS.

C. At such time as the Water Utility is aware that a holder of a Wastewater Discharge Permit is subject to NCPS.

However, lack of notice furnished by the Water Utility will not relieve the holder of a Wastewater Discharge Permit of their obligation to timely comply with NCPS.

Rule 8-04(04). Baseline Monitoring Report (BMR) Filing Requirements. All Baseline Monitoring Reports shall be filed with the Water Utility as follows:

A. Any industrial discharger subject to NCPS that plans to connect to the wastewater collection facilities shall file a BMR with the Water Utility no later than sixty (60) days prior to discharging any

CODE OF GENERAL ORDINANCES, 2021 - KENOSHA, WISCONSIN

wastewater to the collection facilities.

B. New industrial dischargers subject to NCPS shall file a BMR with the Water Utility no later than ninety (90) days prior to the initial discharge of wastewater to the collection facilities.

C. An existing discharger that becomes an industrial discharger subject to NCPS after promulgation of an applicable pretreatment standard shall file a BMR with the Water Utility within one hundred eighty (180) days following the effective date of the categorical standard.

Rule 08-04(05). Required Contents of BMR. A BMR shall be on a Water Utility form and shall contain the following information respecting industrial dischargers subject to NCPS:

A. Identifying Information. The name and address of the discharger, and the names of the persons who own and operate the facility from which there will be a discharge of wastewater into the wastewater collection facilities; and the SIC of the operator.

B. Permits. A listing of any environmental control permits held or applications pending.

C. Description of Operations. A description of the unit processes that the facility plans to use in production.

D. Production. A description of the nature and average rate of production.

E. Points of Discharge. A process schematic diagram indicating points of wastewater discharge.

F. Pretreatment Equipment. Any pretreatment equipment employed at the facility.

G. Flow Measurement. The discharger shall submit information showing the measured average daily and maximum daily flow, in gallons per day, to the POTW from all wastestreams.

H. Measurement of Pollutants. The discharger shall identify the pretreatment standards applicable to each regulated process. Sampling and analysis shall be done on wastestreams that are regulated and results shall identify the nature and concentration of regulated pollutants. Sampling and analysis shall be performed pursuant to 40 CFR 403.12(b)(5)(ii)-(viii). Where alternative sampling is authorized by the POTW under Rule 08-04(10), the samples shall be representative of the discharge and the decision to allow alternative methods shall be documented in the industrial user's file.

I. Certification. A statement, reviewed by an authorized representative of the discharger and certified by a qualified professional, indicating whether pretreatment standards are being met on a consistent basis, and, if not, whether additional operation and maintenance and/or additional pretreatment is required for the discharger to meet the pretreatment standards and requirements.

Rule 08-04(06). Compliance Date Report. Within ninety (90) days following the date for final compliance with applicable categorical pretreatment standards or in the case of a new source following commencement of the introduction of wastewater into the POTW, any industrial discharger subject to NCPS shall submit to the Water Utility a report containing the information described in 40 CFR 403.12 (b) (4)-(6). For all other industrial dischargers subject to NCPS expressed in terms of allowable pollutant discharge per unit of production, this report shall include the discharger's actual production during the appropriate sampling period. This report shall be signed by an authorized representative of the discharger and certified by a qualified professional.

Rule 08-04(07). Periodic Reports on Continued Compliance. Any industrial discharger subject to NCPS shall submit to the Water Utility a report indicating the nature and concentration of pollutants in the effluent which are limited by categorical pretreatment standards. This report shall also include a record of measured or estimated average and maximum daily flows for the reporting period for the discharge reported in Rule 08-04 (05)(G). Compliance reports shall be submitted to the Water Utility during the months of July and January, unless required more frequently by the Water Utility. Flow shall be reported on the basis of actual measurement, except that where cost or feasibility considerations justify, the Water Utility may accept reports of average and maximum flows estimated by verifiable techniques.

Rule 08-04(08). Pretreatment Reporting Requirements. Industrial dischargers subject to NCPS shall comply with the following reporting requirements:

A. All dischargers shall notify the POTW immediately of all discharges that could injure the system or contaminate the sludge, including any slug loadings by the discharger.

B. The reports required in Rule 08-04 (07) shall be based upon data which is representative of conditions occurring during the reporting period. Appropriate sampling and analysis shall be performed

CODE OF GENERAL ORDINANCES, 2021 - KENOSHA, WISCONSIN

during the period covered by the reporting period. The POTW shall require such frequency of monitoring as necessary to assess and assure compliance by discharger, with applicable pretreatment standards and requirements. Sampling and analysis may be performed by the POTW instead of the discharger. When the POTW collects all of the information required for a report, the POTW will not require the discharger to submit the report.

C. If a discharger subject to the reporting requirement in Rule 08-04(07) monitors any pollutant more frequently than required by the POTW, using the procedures prescribed in this Section, the results of this monitoring shall be included in the report required in Rule 08-04(07).

D. The POTW may authorize a monitoring waiver for individual pollutants for an industrial user subject to a categorical standard if the user has demonstrated through sampling and other technical factors as deemed necessary by the POTW that the pollutant is neither present nor expected to be present in the discharge, or is present only at background levels from intake water and without any increase in the pollutant due to activities of the industrial user. This authorization is subject to the following conditions:

1. The POTW may authorize a waiver where a pollutant is determined to be present solely due to sanitary wastewater discharged from the facility provided that the sanitary wastewater is not regulated by an applicable categorical standard and otherwise includes no process wastewater.

2. The monitoring waiver is valid only for the duration of the effective discharge permit, but in no case longer than five (5) years. The user shall submit a new request for the waiver before the waiver may be granted for each subsequent discharge permit or five (5) year period.

3. In making a demonstration that a pollutant is not present, the industrial user shall provide data from sampling of the facility's process wastewater prior to any treatment present at the facility that is representative of all wastewater from all processes. The request for a monitoring waiver shall include the certification statement and be signed in accordance with Wisconsin Administrative Code, NR 211.15(10). Non-detectable sample results may only be used as a demonstration that a pollutant is not present if the EPA approved method from 40 CFR Part 136 with the lowest minimum detection level for that pollutant was used in the analysis.

4. Any grant of the monitoring waiver by the POTW shall be included as a condition in the user's discharge permit. The reasons supporting the waiver and any information submitted by the user in its request for the waiver shall be maintained by the POTW for three (3) years after expiration of the waiver.

5. Upon approval of the monitoring waiver and revision of the user's discharge permit by the POTW, the industrial user shall certify on each report with the statement below, that there has been no increase in the pollutant in its wastestream due to activities of the industrial user: "Based on my inquiry of the person or persons directly responsible for managing compliance with the applicable pretreatment standards, I certify that, to the best of my knowledge and belief, there has been no increase in the level of [list pollutant(s)] in the wastewaters due to the activities at the facility since filing of the last periodic report."

6. In the event that a waived pollutant is found to be present or is expected to be present based on changes that occur in the user's operations, the user shall immediately comply with the monitoring requirements of the discharge permit or other more frequent monitoring requirements and notify the POTW.

7. This paragraph does not supersede certification processes and requirements established in categorical pretreatment standards, except as otherwise specified in the categorical pretreatment standard

8. Where the POTW has authorized a user subject to a categorical pretreatment standard to forego sampling for a pollutant that is not present, the POTW shall sample for the waived pollutant at least once during the term of the user's discharge permit. In the event that the POTW subsequently determines that a waived pollutant is present or is expected to be present in the industrial user's wastewater based on changes that occur in the user's operations, the POTW shall immediately begin at least annual effluent monitoring for that pollutant and inspection.

E. The POTW may determine that an industrial user subject to categorical pretreatment standards is a non-significant categorical industrial user rather than a significant industrial user on a finding that all of the following conditions are met:

1. The industrial user never discharges more than 100 gallons per day of total categorical wastewater, excluding sanitary, non-contact cooling and boiler blowdown wastewater, unless specifically included in the pretreatment standard.

2. The industrial user has consistently complied with all applicable categorical pretreatment

standards and requirements.

3. The industrial user never discharges any untreated concentrated wastewater.

4. The industrial user annually submits the following certification statement signed in accordance with the signatory requirements of Wisconsin Administrative Code, NR 211.15 (10) along with any additional information deemed necessary by the POTW: "Based on my inquiry of the person or persons directly responsible for managing compliance with pretreatment standards, I certify that, to the best of my knowledge and belief that during the period from [date], to [date], the facility described as [facility name] met the definition of a non-significant categorical industrial user as described in NR 211.15 (4) (d); the facility complied with all applicable pretreatment standards and requirements during this reporting period; and the facility never discharged more than 100 gallons of total categorical wastewater on any given day during this reporting period. This compliance certification is based upon the following information: [applicable data]."

5. Where the POTW has determined that an industrial user meets the criteria for classification as a non-significant categorical industrial user in accordance with Wisconsin Administrative Code, NR 211.15 (4) (d), the POTW shall evaluate, at least once per year, whether the industrial user continues to meet those criteria.

F. The POTW may reduce the frequency of the reports required under Rule 08-04(07) to no less than once per year, unless required more frequently by the pretreatment standard or the department, where the industrial user meets all of the following conditions:

1. The industrial user's total categorical wastewater flow does not exceed any of the following:

a. One one-hundredth percent of the design dry weather hydraulic capacity of the POTW, or five thousand (5,000) gallons per day, whichever is smaller, as measured by a continuous effluent flow monitoring device unless the industrial user discharges in batches;

b. One one-hundredth percent of the design dry weather organic treatment capacity of the POTW; and

c. One one-hundredth percent of the maximum allowable headworks loading for any pollutant regulated by the applicable categorical pretreatment standard for which approved local limits were developed by a POTW in accordance with Wisconsin Administrative Code, NR 211.10 (3);

2. The industrial user has not been in significant noncompliance, at any time in the past two (2) years;

3. The industrial user does not have daily flow rates, production levels, or pollutant levels that vary so significantly that decreasing the reporting requirement would result in data that are not representative of conditions occurring during the reporting period;

4. The industrial user shall notify the POTW immediately of any changes at its facility causing it to no longer meet conditions of paragraph 1. or 2. Upon notification, the industrial user shall immediately begin complying with the minimum reporting requirements under Rule 08-04(07) ; and

5. The control authority shall retain documentation to support the determination that a specific industrial user qualifies for reduced reporting requirements under this paragraph for a period of three (3) years after the expiration of the term of the control mechanism.

6. Where the POTW has determined that an industrial user is `subject to reduced reporting requirements as described in, the POTW shall inspect and sample the effluent from the industrial user at least once every two (2) years. If the industrial user no longer meets the conditions for reduced reporting, the POTW shall immediately begin sampling and inspecting the industrial user at least once a year.

Rule 08-04(09). Reports from Noncategorical Significant Industrial Dischargers. The POTW shall require appropriate reporting from those significant industrial dischargers with discharges that are not subject to NCPS. Significant noncategorical industrial dischargers shall submit to the Water Utility at least once every six months, in the months of July and January, a report indicating the nature, concentration, and flow of the pollutants required to be monitored by the Water Utility. These reports shall be based on sampling, and analysis performed in the period covered by the report, and performed in accordance with the techniques described in 40 CFR Part 136 and amendments thereto. Where 40 CFR Part 136 does not contain sampling or analytical techniques, or where the sampling or analytical technique described in 40 CFR Part 136 are inappropriate for the pollutants in question, or where the Administrator otherwise determines, the sampling and analysis shall be performed by using validated analytical methods or any other applicable sampling and analytical procedures, including procedures suggested by the POTW or

other persons approved by the EPA Administrator. Sampling shall be conducted at the appropriate sampling location and shall be representative of conditions during the reporting period. If a user monitors any regulated pollutant more frequently than required by the POTW, the results of this monitoring shall be included in the report. This sampling and analysis may be performed by the POTW. Where the POTW itself collects all information required for the report, the noncategorical significant industrial discharger will not be required to submit the report.

Rule 08-04(10). Sampling Collection and Analysis for SIUs. Sampling and analysis shall be performed to identify the concentration or mass of regulated pollutants in the discharge from each regulated process, according to the requirements of the applicable categorical pretreatment standard and the POTW. Samples shall be representative of daily operations. Grab samples shall be used for pH, cyanide, total phenols, oil and grease, sulfide and volatile organics. All other samples shall be 24-hour flow proportional composites, unless time proportional or grab sampling is authorized by the POTW. Where alternative sampling is authorized by the POTW, the samples shall be representative of the discharge and the decision to allow alternative methods shall be documented in the industrial user's file. Multiple grab samples collected during a 24-hour period may be composited prior to analysis provided appropriate protocols specified in Wisconsin Administrative Code, ch. NR 219, and in EPA and department guidance are followed.

Rule 08-04(11). Notice of Violation/Repeat Sampling and Reporting. If sampling performed by a discharger indicates a violation, the discharger must notify the POTW within twenty-four (24) hours of becoming aware of the violation. The discharger shall also repeat the sampling and analysis and submit the results of the repeat analysis to the POTW within 30 days after becoming aware of the violation, except the discharger is not required to resample if the POTW performs sampling between the discharger's initial sampling and the time when the discharger receives the results of this sampling.

Rule 08-04(12). Notification of Changed Discharge. All industrial dischargers shall promptly notify the POTW in advance of any substantial change in the volume or character of pollutants in their discharge, including the listed or characteristic hazardous wastes for which the industrial user has submitted initial notification under **Rule 08-04(11)**. Significant Industrial Users are required to notify the POTW immediately of any changes at its facility affecting the potential for a Slug Discharge.

Rule 08-04(13). Hazardous Waste Notification. Any industrial discharger who commences the discharge of hazardous waste shall notify the POTW, the EPA Regional Waste Management Division Director, and State hazardous waste authorities in writing of any discharge into the POTW of a substance which, if otherwise disposed of, would be a hazardous waste under 40 CFR Part 261. Such notification must include the name of the hazardous waste as set forth in 40 CFR Part 261, the EPA hazardous waste number, and the type of discharge (continuous, batch, or other). If the industrial discharger discharges more than 100 kilograms of such waste per calendar month to the POTW, the notification shall also contain the following information to the extent such information is known and readily available to the industrial discharger:

- A. An identification of the hazardous constituents contained in the wastes,
- B. An estimation of the mass and concentration of such constituents in the wastestream discharged during that calendar month, and
- C. An estimation of the mass of constituents in the wastestream expected to be discharged during the following twelve (12) months.

All notifications must take place no later than 180 days after the discharge commences.

Dischargers are exempt from the hazardous waste notification requirement during a calendar month in which they discharge fifteen (15) kilograms or less of non-acute hazardous wastes. Discharge of any quantity of acute hazardous waste as specified in 40 CFR 261.30(d) and 261.33(e) requires a onetime notification.

Rule 08-04(14) Signature Requirements. The reports containing analytical data required by this section shall include a certification as defined in NR211.15(10)(a) signed by an Authorized Representative.

Rule 08-05. General Provisions Governing Dischargers Discharging to the Wastewater Collection

Facilities.

Rule 08-05(01). Measurement of Flow. The volume of flow used for computing service charges shall be the metered water consumption of the discharger as shown in the records of meter readings maintained by the Water Utility, except that devices for measuring the volume of wastewater discharged may be required by the Water Utility if this volume cannot otherwise be determined from the metered water consumption records. Metering devices for determining the volume of wastewater shall be approved by the General Manager of the Water Utility and installed, owned, and maintained by the discharger. Such meters, upon approval and installation, shall not be removed without the consent of the General Manager of the Water Utility. New categorical dischargers shall install, maintain, and own flow monitoring equipment for processes which generate categorical wastewater discharges. When a pretreatment system is updated or newly constructed, flow monitoring equipment shall be installed, maintained, and owned by the industrial user. Devices used for measuring flows by methods described in §NR 218.05 shall be calibrated and the calibration rechecked at least annually using one of the following methods:

- A.** A method specified by the manufacturer of the device.
- B.** Calculation of the flow from the dilution of chloride or other ion or substance added to the effluent stream at a fixed rate sufficiently ahead of the sampling point to ensure complete mixing,
- C.** Measuring the volume withdrawn from or introduced into a tank or container in a known period of time, or
- D.** In any specific instance by any other method approved by the General Manager of the Water Utility in response to a written request.

Records of calibration data shall be retained for a three-year period, or for a longer period on specific request of the Water Utility.

Rule 08-05(02). Sampling Manholes. A discharger which discharges wastewater in excess of normal domestic strength wastewater, including all food service facilities, and/or which discharges nonconventional pollutants, shall be required to construct and maintain one (1) or more sampling manholes to facilitate observation, measurement, and sampling of its wastewater. Sampling manholes shall be located as prescribed by or approved by the General Manager. Sampling manholes and related equipment shall be installed by the discharger at his/her cost and expense, and shall be maintained by the discharger so as to be safe, accessible, and in proper operating condition at all times. Plans for the installation and construction of sampling manholes and related equipment shall be approved by the General Manager prior to the commencement of construction or installation. This requirement shall apply to all new construction, change in occupancy, and renovation of existing facilities, and existing facilities classified as Category B Retail.

Rule 08-05(03). Wastewater Sampling. Any wastewater discharged into the wastewater collection facilities shall be subject to periodic inspection by the Water Utility to determine the character and concentration thereof, without notice to the discharger.

Rule 08-05(04). Grease and Oil, Sand Separators and Sand Basins. A discharger (other than cooking and/or food waste) who utilizes a garage catch basin, or grease or oil interceptor/separator which is connected to the wastewater collection facilities shall install, at its cost and expense, a sampling manhole on the sewer lateral. The manhole shall be located outside of the building, on private property and, if possible, accessible by a van/truck. The design of the manhole shall be as shown in "Standard Specifications for Sewer and Water Construction in Wisconsin" (latest edition) or as approved by the General Manager.

Rule 08-05(05). Monitoring of Municipalities. Municipalities other than the City of Kenosha shall monitor their wastewater and report their findings as to the wastewater volume, BOD, suspended solids, phosphorus, and oil at the cost and expense of the municipality, as directed by the General Manager. Metering stations may be required by the General Manager to be installed and maintained at the cost and expense of the municipality. The General Manager shall have the right to install flow monitoring and sampling equipment to check the results reported by a municipality, and in the event of a dispute or conflict, the findings and determinations of the Water Utility shall control, all in accordance with the municipality's Wastewater Discharge Permit.

Rule 08-05(06). Analysis. All measurements, testing and analysis shall be performed in accordance with 40 CFR Part 136 and amendments thereto. Where 40 CFR Part 136 does not contain sampling or analytical techniques for the pollutant in question, or where the Administrator determines that the Part 136 sampling and analytical techniques are inappropriate for the pollutant in question, sampling and analysis shall be performed by using validated analytical methods or any other applicable sampling and analytical procedures, including procedures suggested by the POTW or other parties, as approved by the Administrator. Sampling method, location, time, duration and frequency are determined on a case-by-case basis, subject to the approval by the Water Utility.

Rule 08-05(07). Confidential Information. Information and data obtained by the Water Utility pursuant to this Section with respect to the nature and frequency of wastewater discharges shall be available to the public or other governmental agencies, without restriction, unless the discharger specifically requests confidentiality and is able to satisfactorily demonstrate that the release of such information would divulge information, processes, or methods of production entitled to protection as trade secrets. When the Water Utility grants a request for confidentiality, the portions of a report which are confidential shall not be made available for inspection to the public, but shall be made available, upon written request, to governmental agencies for uses related to this Section. The National Pollutant Discharge Elimination System (NPDES) Permit, and Wisconsin Pollutant Discharge Elimination System (WPDES) Permit shall also be available for use by any party involved in judicial or administrative review or enforcement proceedings involving the discharger furnishing the report. Wastewater constituents and characteristics are not recognized as confidential information.

Rule 08-05(08). Bypass. Bypass is prohibited, and the POTW may take enforcement action against an industrial user for a bypass, unless:

- A.** The bypass was unavoidable to prevent loss of life, personal injury, or severe property damage;
- B.** There were no feasible alternatives to the bypass, such as the use of auxiliary treatment facilities, retention of untreated wastes, or maintenance during normal periods of equipment downtime. This condition is not satisfied if adequate backup equipment should have been installed in the exercise or reasonable engineering judgment to prevent a bypass which occurred during normal periods of equipment downtime or preventative maintenance; and,
- C.** The industrial user submitted notices as required under this rule.

If an industrial user knows in advance of the need for a bypass, it shall submit prior notice to the POTW, at least ten days before the date of the bypass, if possible.

An industrial user may allow any bypass to occur which does not cause pretreatment standards or requirements to be violated, but only if it also is for essential maintenance to assure efficient operation. An industrial user shall submit oral notice of an unanticipated bypass that exceeds applicable pretreatment standards to the POTW within twenty-four (24) hours from the time it becomes aware of the bypass. A written submission shall also be provided within 5 days of the time the industrial user becomes aware of the bypass. The written submission shall contain a description of the bypass and its cause; the duration of the bypass, including exact dates and times, and if the bypass has not been corrected, the anticipated time it is expected to continue; and steps taken or planned to reduce, eliminate, and prevent reoccurrence of the bypass.

The POTW may approve an anticipated bypass, after considering its adverse effects, if the POTW determines that the user will meet the three conditions listed above in 08-05(08) A, B, and C.

Rule 08-05(09). Upset. An upset shall constitute an affirmative defense to an action brought for noncompliance with pretreatment standards if the requirements of the next paragraph are met.

A. An industrial user who wishes to establish the affirmative defense of upset shall demonstrate, through properly signed, contemporaneous operating logs, or other relevant evidence that:

- 1.** An upset occurred and user can identify the cause(s) of the upset.
- 2.** The facility was at the time being operated in a prudent and workmanlike manner and in compliance with applicable operation and maintenance procedures.
- 3.** The user has submitted the following information to the POTW within twenty-four (24) hours of becoming aware of the upset (if this information is provided orally, a written submission must be provided

within five (5) days):

- (a) A description of the discharge and cause of noncompliance.
 - (b) The period of noncompliance, including exact dates and times or, if not corrected, the anticipated time the noncompliance is expected to continue.
 - (c) Steps being taken and/or planned to reduce, eliminate and prevent recurrence of the noncompliance.
4. In any enforcement proceeding, the user seeking to establish occurrence of an upset shall have the burden of proof.
5. The user shall control production or all discharges to the extent necessary to maintain compliance with pretreatment standards upon reduction, loss, or failure of its treatment facility until the facility is restored or an alternative method of treatment is provided. This requirement applies in the situation where, among other things, the primary source of power of the treatment facility is reduced, lost or fails.

Rule 08-07. Reassignment of Dischargers. The General Manager will reassign dischargers into appropriate service charge categories where Water Utility records indicate facts supporting such a change. Dischargers will be given an opportunity to be heard on the proposed action before it becomes effective.

Rule 08-08. Enforcement of Wastewater Discharge Permit.

Rule 08-08(01). Written Notice of Violation. Any discharger in violation of a Wastewater Discharge Permit issued to it, shall be served with a written notice stating the nature of the violation and the action proposed to be taken by the Water Utility, in response to such violation.

Rule 08-08(02). Administrative Order(s). The General Manager shall have the following courses of action as options which may be taken, jointly or severally, in response to a violation of a Wastewater Discharge Permit:

- A. To issue an order to immediately cease the unlawful conduct identified in a notice of violation.
- B. To issue an order to cease the unlawful conduct identified in a notice of violation within a specified period of time.
- C. To pursue penalties and legal remedies as provided in Section 32.11.
- D. To make a claim for damages occasioned by injury to the system or contamination of the sludge.
- E. To suspend or revoke a Wastewater Discharge Permit.
- F. To commence an action at law or in equity in the State or Federal Courts for a declaratory judgment, monetary damages, and/or a temporary or permanent injunction.
- G. To commence an action at law for a court imposed compliance schedule.

Rule 08-08(03). Opportunity for and Purpose of Hearing. The notice of violation shall provide the discharger with an opportunity for a hearing prior to enforcement action being taken. Such notice shall provide a time within which the discharger may request a hearing, which time limit shall be reasonable under the circumstances. Following a request for a hearing, a hearing shall be held before the General Manager and the violator shall be notified, in writing, of the time, date and place thereof. The purpose of such hearing shall be to determine the existence of mitigating factors, if any, and to determine the factual basis underlying the alleged violation. The failure to make a timely, written request for a hearing shall constitute a waiver of the right to such hearing. However, in the event of an emergency, an order under Rule 08-08 (02) A. may be issued without a written notice and prior hearing, provided that such written notice and hearing are provided as soon as possible following the issuance of said order.

Rule 08-08(04). Written Determination. Within ten (10) days following the hearing, or in the absence of a timely request for a hearing, within ten (10) days following the last day on which a hearing could have been requested, a written determination report shall be made.

Rule 08-08(05). Grounds for Suspension, Revocation, or NonRenewal of Wastewater

Discharge Permit. The General Manager of the Water Utility may commence an administrative proceeding, upon written notice, and an opportunity to be heard, to seek the suspension, revocation or nonrenewal of any Wastewater Discharge Permit should a discharger:

A. Fail to factually report to the Water Utility the constituents and characteristics of its wastewater discharge.

B. Fail to promptly report to the Water Utility any violation by it of this Section or of any order promulgated under authority of this Section or any violation of any permit it may hold issued pursuant to this Section.

C. Fail to promptly report to the Water Utility any significant change in the constituents and characteristics of its wastewater discharge.

D. Fail to provide to the Water Utility reasonable access to its premises for inspection, sampling and monitoring purposes.

E. Fail to abide by the terms and conditions of this Section, any order promulgated under authority of this Section, any permit issued pursuant to this Section or any court order enforcing this Section and orders promulgated under its authority.

F. Fail to provide accurate and truthful information and statements to the Water Utility.

G. Attempt to or tamper with any sampling, or monitoring equipment or with the analysis or reports required by this Chapter.

H. Fail to timely file an amended permit application where one is required by this Section.

Rule 08-09. Service of Notices, Findings, and Determinations. Service of notices, findings, and determinations provided for in this Section shall be by personal service or by Certified Mail with Return Receipt. Notices to the Water Utility shall be served at or delivered to the Water Utility Business Office.

Rule 08-10. Procedures for Review. Any discharger, permit applicant, or permit holder adversely affected by any decision, action or determination made by the General Manager of the Water Utility interpreting or implementing the provisions of this Section or of any permit issued herein, may file with the General Manager of the Water Utility a written request for reconsideration within ten (10) days of the date of such decision, action, or determination, setting forth in detail the facts and arguments supporting the request for reconsideration. The General Manager of the Water Utility shall render a decision on the request for reconsideration, in writing, within fifteen (15) days of receipt of the request. If the decision on the request for reconsideration made by the General Manager of the Water Utility is unsatisfactory to the party requesting the reconsideration, then such party may, within ten (10) days after notification of such decision, file a written appeal with the Board. The written appeal shall be heard by the Board within forty-five (45) days from the date of filing. The Board shall make a final ruling on the appeal within sixty (60) days from the date of the filing of an appeal.

Rule 08-11. Annual Publication of Enforcement Proceedings. The Water Utility shall annually publish, in the largest daily newspaper published in Kenosha, a list of industrial users which, during the previous twelve (12) months, were in significant noncompliance with applicable pretreatment standards and requirements. Significant noncompliance and/or criteria are listed in 08-01.

Rule 08-12 Grease Management.

Rule 08-12(01) Purpose. The purpose of this rule is to establish uniform requirements for food service establishments discharging grease wastewater into the Water Utility wastewater collection system and to enable the Water Utility to comply with all applicable federal and state laws, including those, which apply to sanitary sewer overflows.

Rule 08-12(02) Food Service Establishments.

A. General. All food service establishments are required to have a grease trap or grease interceptor as per the requirements of the Wisconsin Administrative Code, SPS 382.34(5) as may be amended from time to time.

B. New facilities. Upon the effective date of this rule, food service establishments which are newly proposed or constructed, or existing facilities which will be expanded or renovated, where such

CODE OF GENERAL ORDINANCES, 2021 - KENOSHA, WISCONSIN

facility did not previously exist, shall be required to install, operate and maintain a grease interceptor or grease trap according to the requirements of the Wisconsin Administrative Code, SPS 382.34(5).

C. Existing facilities. For the purposes of sizing and installation of grease interceptors, all food service establishments existing prior to the effective date of this rule shall be permitted to operate and maintain existing grease interceptors or grease traps provided same are in efficient operating condition. Upon the effective date of this rule, the Water Utility may require an existing food service establishment to install, operate and maintain a new grease interceptor or trap that complies with the requirements of this chapter or to modify or repair any noncompliant plumbing or existing interceptor or trap within ninety (90) days of written notification by the Water Utility when any one or more of the following conditions exists:

1. The facility is found to be contributing oils and grease in quantities sufficient to cause line stoppages or necessitate increased maintenance on the wastewater collection system;
2. The facility has an undersized, irreparable or defective grease interceptor or trap;
3. The facility has a garbage grinder;
4. Remodeling of the food preparation or kitchen waste plumbing system is performed which requires a plumbing or building permit to be issued;
5. The existing facility is sold or undergoes a change of ownership.

D. Plumbing connections. Grease interceptors or traps shall be located in the food service establishment's lateral sewer line after all fixtures that may introduce grease into the sewer system and the connection to the wastewater collection system. Such fixtures shall include but not be limited to, sinks, dishwashers, automatic hood wash units, floor drains in food preparation and storage areas, and any other fixture which is determined to be a potential source of grease. Garbage grinders installed within food service establishments shall be plumbed through the grease interceptor(s) and a solids interceptor shall separate the discharge before connecting to the grease trap. Solids interceptors and grease interceptors shall be sized and rated for the discharge of the garbage grinder. Wastewater from sanitary facilities and other similar fixtures shall not be introduced into the grease interceptor or trap under any circumstances.

E. Grease interceptors. Grease interceptors shall be installed at all new food service establishments as specified by the Wisconsin Administrative Code, SPS 382.34(5). All food service establishments shall comply with the following guidelines:

1. Inspection, pumping, and maintenance. Each food service establishment shall be responsible for the costs of installing, inspecting, pumping, cleaning and maintaining its grease interceptor. Pumping services shall include the initial complete removal of all contents, including floating materials, wastewater and bottom sludge and solids from the interceptor. Grease interceptor cleaning shall include scraping excessive solids from the walls, floors, baffles and all pipe work. The return of gray water back into the grease interceptor from which the wastes were removed is allowable, provided that grease and solids are not returned to the interceptor. The grease hauler shall wait at least twenty (20) minutes to allow the interceptor waste to separate in the truck tank before attempting to re-introduce the gray water to the interceptor. It shall be the responsibility of each food service establishment to inspect its grease interceptor during the pumping procedure to ensure that the interceptor is properly cleaned out and that all fittings and fixtures inside the interceptor are in working condition and functioning properly.

2. Interceptor pumping frequency. Each food service establishment shall determine the frequency at which its grease interceptor(s) shall be pumped according to the following criteria:

- a. When the floatable grease layer exceeds six (6) inches in depth as measured by an approved dipping method; or,
- b. When the settleable solids layer exceeds eight (8) inches in depth as measured by an approved dipping method; or,
- c. When the total volume of settleable solids is more than three quarters (3/4) of the total clearance of the outlet pipe located at the bottom of the interceptor; or,
- d. When the total volume of captured grease and solid material displaces more than twenty (20) percent of the capacity of the interceptor as calculated using an approved dipping method.

3. Repairs. Each food service establishment shall be responsible for the cost and scheduling of all repairs to its grease interceptor(s). Repairs required by the Water Utility shall be completed within ten (10) calendar days after written notice is received by the facility unless the Water Utility establishes a different compliance date.

4. Disposal. Wastes removed from each grease interceptor shall be disposed of at a facility

permitted to receive such wastes. Neither grease nor solid materials removed from interceptors shall be returned to any grease interceptor, private sewer line or to any portion of the wastewater collection system.

F. Interceptor additives prohibited. Any chemicals, enzymes, emulsifiers, live bacteria or other grease cutters or additives are prohibited.

G. Alternative grease removal devices or technologies. Alternative devices and technologies such as automatic grease removal systems shall be subject to written approval by the Water Utility prior to installation. Approval of the device shall be based on demonstrated (proven) removal efficiencies and reliability of operation. The Water Utility may approve these types of devices depending on manufacturers' specifications on a case-by-case basis. The food service establishment may be required to furnish analytical data demonstrating that grease discharge concentrations to the wastewater collection system will not exceed the established limitation.

Rule 08-12(03) Entry, Inspection, Sampling, and Reporting.

A. Entry. All food service establishments shall allow Water Utility personnel, bearing proper credentials and identification, access to all parts of the premises during reasonable business hours, for the purpose of inspection, observation, and sampling in accordance with the provisions of this rule. Any user refusing the Water Utility entry to or upon the premises of the user for the purposes of inspection, sampling effluents or performing such other duties as required by this rule shall constitute a violation of the terms of this rule. The Water Utility may seek a warrant or use any other legally available procedures to discharge their duties.

B. Inspection and sampling. The Water Utility may inspect the facilities of any food service establishment, to determine compliance with this rule. Grease interceptors shall be inspected as necessary to insure compliance with specific grease interceptor requirements and to determine if proper cleaning and maintenance schedules are being performed.

The Water Utility may collect effluent samples to determine compliance. The Water Utility shall re-inspect any user that received a deficiency notice after the original inspection. In the event that the user is compliant with all of the deficiencies, there shall be no charge for the re-inspection. In the event of continuing non-compliance, successive re-inspections will be scheduled and appropriate fees shall be charged to the user for the first and all successive re-inspections. Such fees may be charged to the appropriate account of the customer's sewer bill.

C. Reporting. Owners of grease trap/interceptors shall obtain records from contractors used to remove grease waste showing the volume of grease waste shipped; the name and address of the destination; and the name and address of the contractor. Owners of grease trap/interceptors shall maintain these records for a minimum of five years and make them available to the Water Utility for inspection and copying upon request.

Rule 08-12(04) Enforcement and Damage Assessment.

A. Enforcement response plan. Whenever the Water Utility determines that a grease interceptor is in need of pumping, repairs or other maintenance, or in the event that an additional grease interceptor is required, the Water Utility shall proceed as prescribed below:

1. If during inspection, the Water Utility determines that a violation exists, the Water Utility shall immediately notify the owner/manager of the food service establishment that a violation exists and must be addressed promptly.

2. The Water Utility may issue the food service establishment a notice of violation (NOV) stating the nature of the violation(s). Upon issuance of a NOV:

The Water Utility shall perform a first re-inspection after a minimum of fifteen (15) calendar days after issuance of the NOV, to allow sufficient time for corrective action by the food service establishment to be completed. In the event that the food service establishment is compliant with all of the deficiencies, there shall be no charge for the re-inspection. If all of the deficiencies have not been corrected, a first re-inspection fee shall be charged to the food service establishment.

A second re-inspection will be performed after a minimum of ten (10) additional calendar days have passed. In the event that the food service establishment is compliant with all of the deficiencies, there shall be no additional charge for the re-inspection. If deficiencies remain, a second re-inspection shall be charged to the food service establishment.

Additional re-inspections and fees will be assessed until the food service establishment is

compliant with all of the deficiencies. If necessary, additional enforcement actions may be necessary.

Fees shall be established and, when necessary, modified by the Board.

B. Assessment of damages. When the discharge from a food service establishment causes an obstruction, damage or any other impairment to the facilities or any expense of whatever character or nature to the Water Utility, the Water Utility may charge the expenses incurred to the discharger. The expenses include services to clear the obstruction, repair the damage to the Utility's facilities or to recover any other expenses for damage(s) of any kind or nature suffered by the Water Utility. The Water Utility shall file a claim with the food service establishment or person causing the damages for any and all expenses or damages suffered by the Water Utility. If the claim is ignored or denied, the Water Utility may charge the expense to the Water Utility sewer bill, or notify the city attorney to take such measures as shall be appropriate to recover any expense or damages suffered by the Water Utility.

Rule 08-12(05) Permit Requirements.

A. It is unlawful for any facility to discharge effluent from a grease interceptor without authorization from the Water Utility. Authorization shall be given in the form of a Grease Interceptor Permit. Application for a permit shall be made to the Water Utility. If the Water Utility determines that the proposed discharge does not conflict with the provisions of this Chapter, or any other federal, state or local requirement or regulation, and the permit fee is paid, a permit shall be issued allowing the facility to discharge into the sanitary sewer collection system. Each grease interceptor permit shall be issued for a time not longer than three years from the date of the permit. The grease generator shall apply for permit re-issuance prior to the expiration of the grease generator's existing permit.

Rule 08-12(06) Fees. The Board may establish and, from time to time, modify charges, surcharges, and fees for permit application, operation, enforcement, administration, and reimbursement of costs incurred.

Rule 08-13. Amalgam Management at Dental Offices.

A. This rule applies to any dental office that places or removes amalgam. If work in a dental office is limited to work that does not involve placing or removing amalgam, such as orthodontics, periodontics, maxillo-facial surgery, endodontics, or prosthodontics, then this rule does not apply.

B. All dental offices shall implement best management practices for amalgam as established by the Wisconsin Dental Association.

C. Within the shortest reasonable time, but no later than four years from the effective date of this Chapter, every vacuum system where amalgam is used or removed shall include an amalgam separator that meets the criteria of the International Standards Organization for amalgam removal equipment (ISO 11143). Dental office shall install, operate and maintain the amalgam separator according to manufacturer's instructions. The amalgam separator shall have a design and capacity appropriate for the size and type of vacuum system.

D. Within one year of the adoption of this Chapter, each dental office shall submit a report that certifies the implementation of the management practices required by paragraph 08-13 B and identifies the contractors used to remove amalgam waste within the last twelve months.

E. Within two years of the adoption of this Chapter, each dental office shall provide a schedule for the installation of the amalgam separator required by paragraph 08-13 C.

F. Within three years of the adoption of this Chapter, each dental office shall provide the following information:

1. The installation date, manufacturer and model name of the amalgam separator, if the installation of the separator is completed.

2. A brief explanation of the delay, anticipated installation schedule, proposed manufacturer and model name of the amalgam separator, if the separator has not yet been installed.

G. If the dental office has provided a report according to paragraph 08-13 F, the dental office shall notify the Water Utility of the completion of the installation within five days after completion.

H. Dental offices shall obtain records for each shipment from contractors used to remove amalgam waste showing the volume or mass of amalgam waste shipped; the name and address of the destination; and the name and address of the contractor. Dental offices shall maintain these records for a minimum of five years and make them available to the Water Utility for inspection and copying upon

request.

I. Dental offices shall allow the Water Utility to inspect vacuum system, amalgam separator, and amalgam waste storage areas upon request. Inspections shall occur during the normal operating schedule of the dental office.

J. If the dental office is implementing the management practices required by paragraph 08-13 B and is operating and maintaining the amalgam separator required by paragraph 08-13 C, then any numerical discharge limit for mercury established in any other section of this Chapter does not apply.

Rule 08-14. Record Retention by Dischargers. Dischargers subject to this Section shall retain and preserve, for no less than three (3) years, any records, books, documents, memoranda, reports, correspondence, and any and all summaries thereof relating to monitoring, sampling and chemical analyses made in connection with its wastewater discharge. All records that pertain to matters that are the subject of administrative adjustment or any other enforcement or litigation activities brought by the Water Utility pursuant hereto shall be retained and preserved by the discharger until all enforcement activities and related review proceedings have concluded and all periods of limitation with respect to any and all appeals have expired. Records of any contractor or agent of the discharger must be retained by the discharger.

32.09 PRIVATE WELLS

Rule 09-01. Prohibition. No person, whose premises are served with water from the Water Utility shall maintain or use a private well as a source of domestic potable water, within the Water Utility service area, without first obtaining and maintaining a permit thereafter as hereinafter provided.

Rule 09-02. Requirement. Within twelve (12) months following connection of any premises to the Water Utility water system, the owner shall discontinue use of any private well serving the premises and fill the well as hereinafter provided, unless a permit to maintain a private well is obtained from the General Manager of the Water Utility.

Rule 09-03. Private Well Permits. The General Manager of the Water Utility may issue a Private Well Permit for a period not to exceed five (5) years, subject to the following conditions:

E. The well and pump installation meet the requirements of Wisconsin Administrative Code, NR §812, and a well constructor's report is on file with the Department of Natural Resources, or certification of the acceptability of the well has been granted by the Private Water Supply Section of the Department of Natural Resources.

F. The well has a history of producing bacteriologically safe water as evidenced by a minimum of one (1) safe sampling every five (5) years for renewal or initial well permit.

G. No physical connection shall exist between the piping of the public water system and the private well.

H. The well and pump system shall be evaluated by a licensed well driller or pump installer and certified to comply with the Wisconsin Administrative Code, NR 812 every ten (10) years with the first inspection being done prior to issuance of first or initial well permit. Written documentation of the well and pump inspection indicating compliance with the Wisconsin Administrative Code, NR 812 requirements must be submitted to the Water Utility.

I. The renewal application along with all supporting documentation must be accompanied by the well permit fee and submitted to the Water Utility prior to permit issuance.

Rule 09-04. Disconnection. The owner of any premises possessing a nonpermitted private well shall discontinue the use thereof and fill it as hereinafter provided.

Rule 09-05. Private Well Filling Requirements. Private wells to be abandoned hereunder shall be filled according to the procedures outlined in Wisconsin Administrative Code NR §812.26. The pump and piping must be removed and the well checked for obstructions prior to plugging. An obstruction or liner must be removed.

Rule 09-06. Reports and Inspection. A well abandonment report must be submitted by the well owner to the Department of Natural Resources on forms provided by that agency, immediately upon completion of the filling of the private well. The filling of the private well must be observed by a

representative of the Water Utility. Notice of appropriate DNR filings shall be provided by the well owner to the Water Utility as soon as possible.

32.10 APPEAL

An aggrieved person adversely affected by the denial of a permit or decision, determination or interpretation by the General Manager may appeal such denial, decision, determination or interpretation to the Board of Water Commissioners. A hearing thereon shall be conducted before the Board of Water Commissioners.

32.11 PENALTIES AND LEGAL REMEDIES

Rule 11-01. Legal Remedies. Any person who violates any of the provisions of this Chapter, shall, in addition to the forfeiture hereinafter provided, be liable for any damage to the Water Utility including loss of revenue from the sale of water or sewerage service resulting from a violation of these rules and regulations. Where the Water Utility must take corrective action with respect to any parcel of property, such parcel may be specially assessed for such work. The payment of damages and the correction of violations may be a condition of providing future water or sewerage service.

Rule 11-02. Penalties. Any person who violates any provision of this Chapter, or orders authorized by this Chapter, may, upon conviction thereof, forfeit not less than One Thousand (\$1,000.00) Dollars, together with the costs of prosecution and all applicable surcharges and fees for each violation. Each day a violation continues shall be deemed a separate offense. In default of the timely payment of such a forfeiture and costs, the violator shall be imprisoned in the Kenosha County Jail for not more than thirty (30) days or have their drivers privileges suspended for up to two years.

The forfeiture above provided for shall be in addition to all other remedies specified in this Chapter or available in law or equity.

APPENDIX
DRAWING #1

Kenosha Water Utility Meter Setting 1987

BASEMENT TYPE
5/8 Inch - 1 Inch

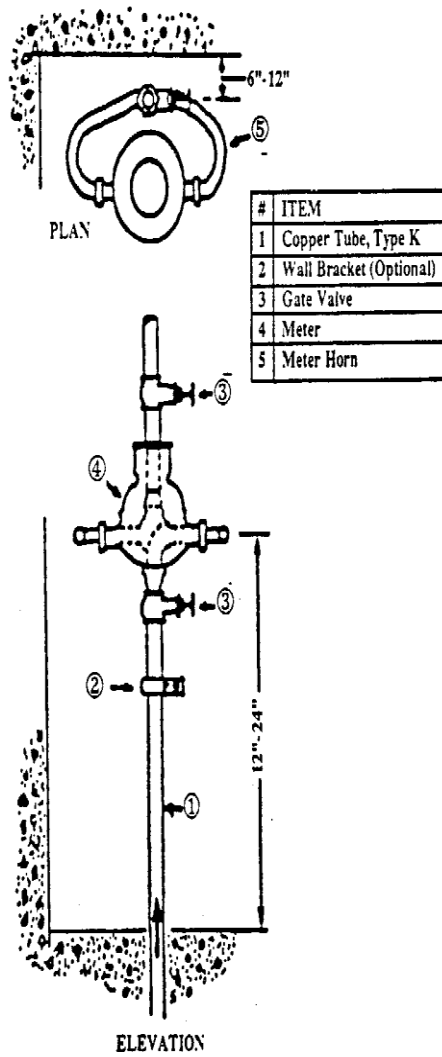

APPENDIX
DRAWING #2

KENOSHA WATER UTILITY METER SETTING 1987

LARGE METERS
2 Inches & Larger

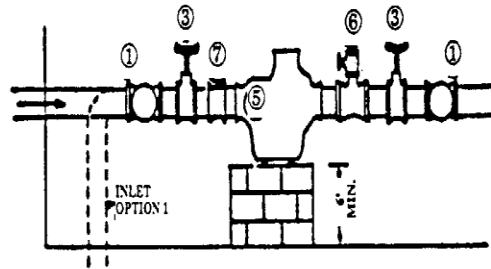

ELEVATION

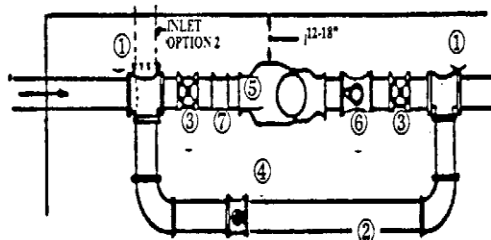

PLAN

#	ITEM
1	Tee for Bypass
2	Solid Bypass
3	Gate Valve
4	Sealed Gate Valve
5	Meter
6	Test Tee with Gate Valve:(not required with 2" meter) 2 inch Gate Valve for 3-6 inch meters 3 inch Gate Valve for 8-10 inch meters
7	Solid Sleeve

NOTE: All flanges must be 125# standard. All steel must be galvanized.

APPENDIX
DRAWING #3

KENOSHA WATER UTILITY
WATER SERVICE PIPING
1987

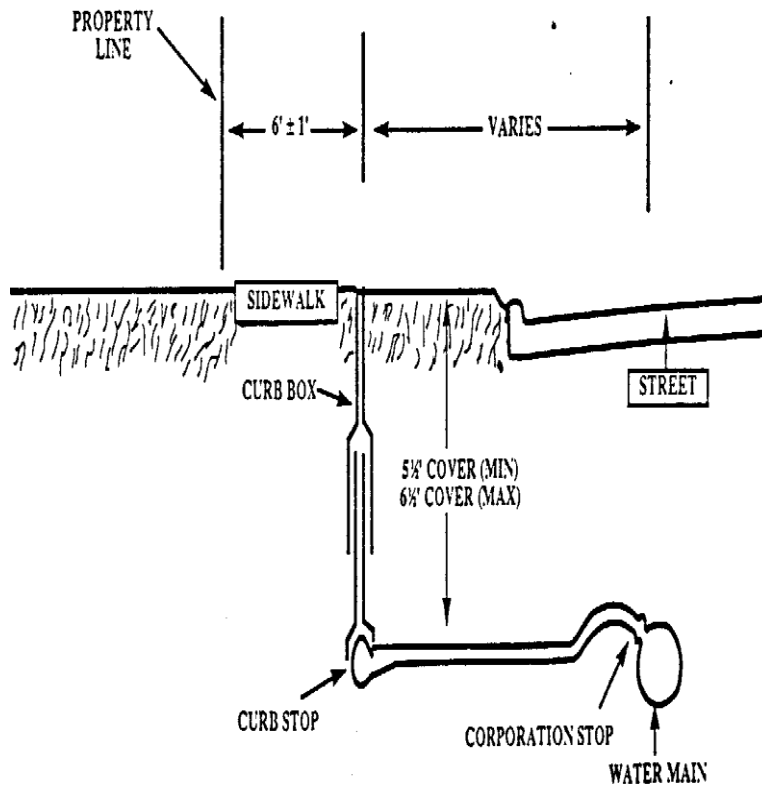

APPENDIX
DRAWING #4

KENOSHA WATER UTILITY METER PIT 1987
LARGE SERVICES (2 Inches & Larger)

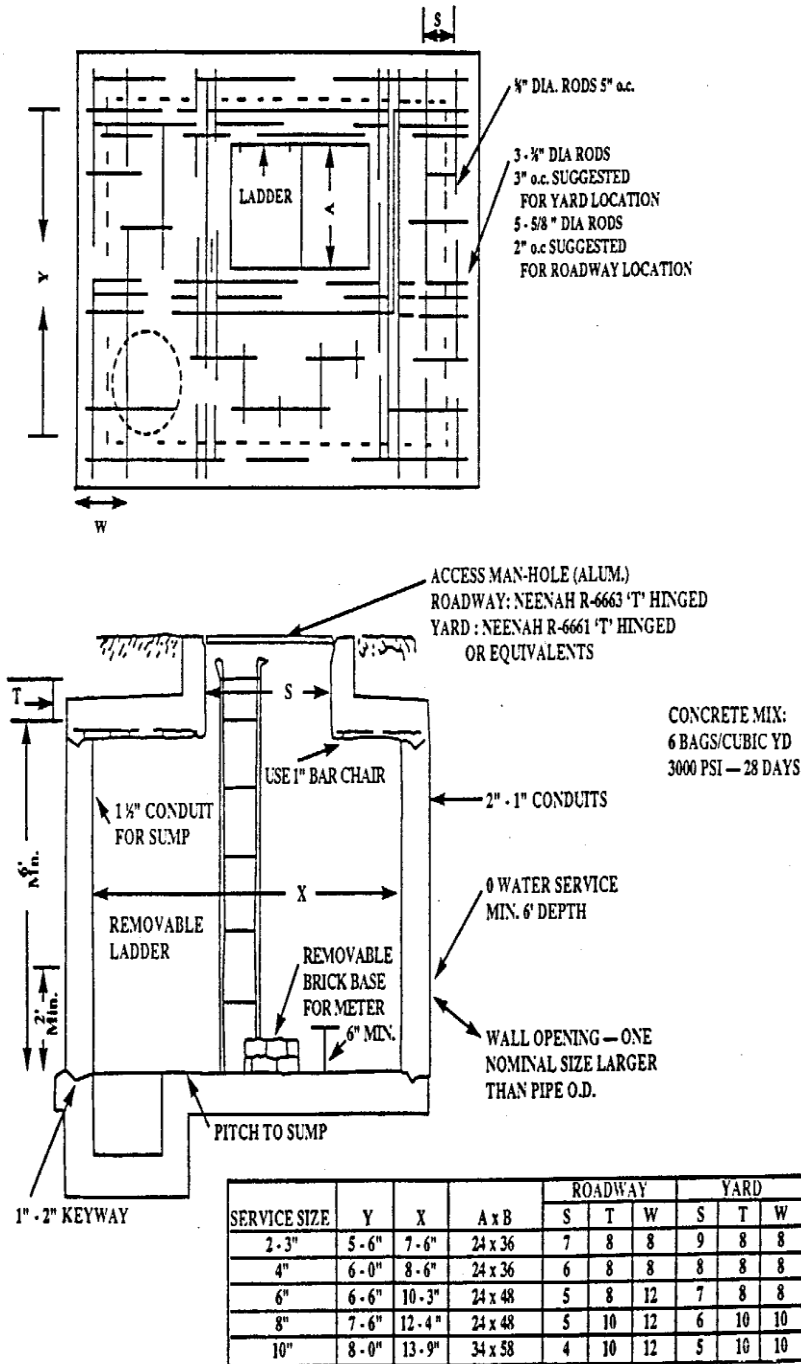

APPENDIX
DRAWING #5

KENOSHA WATER UTILITY FIRELINE SERVICE 1987

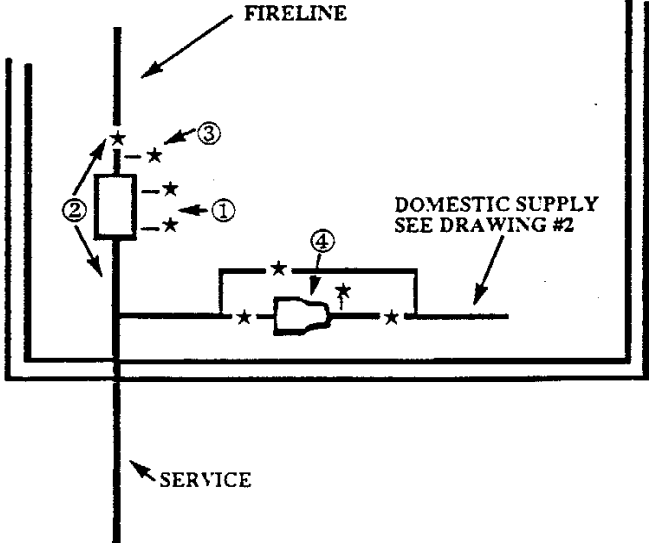

#	ITEM
1	Director Check
2	Gate Valve
3	Test Tee with Gate Valve
4	Meter

CHAPTER XXXIII
LAND-DISTURBING EROSION AND
SEDIMENT CONTROL ORDINANCE

33.01 AUTHORITY

A. Statutory Authority. This Chapter is adopted pursuant to Section 62.234 of the Wisconsin Statutes. Except as otherwise specified in Wisconsin Statutes Section 62.234, Section 62.23 of the Wisconsin Statutes applies to this Chapter and to any amendments to this Chapter.

B. Construction Not Limiting. The provisions of this Chapter are to be construed so as not to limit any other lawful regulatory powers of the City of Kenosha.

C. Administration. This Chapter 33 shall be administered and enforced by the Director of Public Works, or his/her designee.

33.02 FINDINGS AND PURPOSE

A. Findings. The Common Council finds that runoff from land-disturbing construction activity carries a significant amount of sediment and other pollutants to the waters of the State in the City.

B. Purpose. It is the purpose of this Chapter to further the maintenance of safe and healthful conditions; prevent and control water pollution; prevent and control soil erosion; protect spawning grounds, fish and aquatic life; control building sites, placement of structures and land uses; preserve ground cover and scenic beauty; and promote sound economic growth by minimizing the amount of sediment and other pollutants carried by runoff or discharged from land-disturbing construction activity to waters of the State in the City.

33.03 INTENT

The intent of this Chapter is to require use of best management practices to reduce the amount of sediment and other pollutants resulting from land-disturbing construction activities. Use of this Chapter will foster consistent, Statewide application of the construction site performance standards for new development and redevelopment contained in Subchapters III and IV of Chapter NR 151, Wisconsin Administrative Code.

33.04 APPLICABILITY OF CODE

A. Applicability. This Chapter applies to the following land-disturbing construction activities except as provided under Subsection B:

An Erosion Control Permit shall be required, and all construction site erosion control provisions of this Chapter shall apply, to any of the following activities:

- a. Land-disturbing activity on a slope of greater than twelve (12%) percent.
- b. Land-disturbing activity that involves the excavation or filling, or a combination of excavation and filling.
- c. Land-disturbing activity that disturbs more than one hundred (100) linear feet of road ditch, grass waterway or other land area where surface drainage flows in a defined open channel; including the placement, repair or removal of any underground pipe, utility or other facility within the cross-section of the channel.
- d. Any new private roads or access drives longer than one hundred twenty-five (125') feet.
- e. Development that requires a subdivision plat, as defined in the applicable local land division Chapter(s).
- f. A construction site that has one (1) or more acres of land-disturbing construction activity.

B. Exemptions. This Chapter does not apply to the following:

1. A construction project that is exempted by Federal statutes or regulations from the requirement to have a National Pollutant Discharge Elimination System Permit issued under Chapter 40, Code of Federal Regulations, Part 122, for land-disturbing construction activity.
2. Nonpoint discharges from agricultural facilities and practices.
3. Nonpoint discharges from silviculture activities.
4. Routine maintenance for project sites under five (5) acres of land disturbance if performed to maintain the original line and grade, hydraulic capacity or original purpose of the facility.
5. **Exemptions For Municipal Road or County Highway Projects.** Municipal road or County highway projects are exempt where all of the activity takes place within existing public right-of-ways.

C. Applicability to Excluded or Exempted Sites. Notwithstanding the applicability requirements in Subsection A, or the exemptions in Paragraphs B.2. through B.5., this Chapter applies to construction sites of any size that, in the opinion of the Code Official, or designee, are likely to result in runoff that exceeds the safe capacity of the existing drainage facilities or receiving body of water, that causes undue channel erosion, that increases water pollution by scouring or the transportation of particulate matter, or that endangers property or public safety.

This Chapter applies to land-disturbing construction activities on lands within the boundaries and jurisdiction of the City, as well as the extraterritorial division of land subject to an ordinance enacted pursuant to Sections 236.45(2) and (3) of the Wisconsin Statutes.

This Chapter is not applicable to activities conducted by a State agency, as defined under Section 277.02(1) of the Wisconsin Statutes, but also including the office of District Attorney, which is subject to the State plan promulgated or a memorandum of understanding entered into under Section 281.33 of the Wisconsin Statutes.

33.05 INTERPRETATION

In their interpretation and application, the provisions of this Chapter shall be held to be minimum requirements and shall be liberally construed in favor of the City of Kenosha, and shall not be deemed a limitation or repeal of any other power granted by Wisconsin Statutes.

33.06 JURISDICTION AND ADMINISTRATION

A. Jurisdiction. This Chapter applies to all areas of the City of Kenosha, Wisconsin.

B. Conflict. Where the standards of this Chapter differ or conflict with applicable local land division, zoning, shoreland zoning or other applicable local Ordinances or State regulations, the more restrictive standards shall apply.

33.07 DEFINITIONS

Agricultural Facility means a structure associated with an agricultural practice, per the meaning given in Section 281.16 of the Wisconsin Statutes, or as amended.

Agricultural Practice means beekeeping; commercial feedlots; dairying; egg production; floriculture; fish or fur farming; grazing; livestock raising; orchards; poultry raising; raising of grain, grass, mint and seed crops; raising of fruits, nuts and berries; sod farming; placing land in Federal programs in return for payments in kind; owning land, at least thirty-five (35) acres of which is enrolled in the Conservation Reserve Program under 16 USC 3831 to 3836; and, vegetable raising, per the meaning given in Section 281.16 of the Wisconsin Statutes, or as amended.

Average Annual Rainfall means a calendar year of precipitation, excluding snow, which is considered typical.

Best Management Practice (BMP) means structural or non-structural measures, practices, techniques or devices employed to avoid or minimize soil, sediment or pollutants carried in runoff to waters of the State.

CODE OF GENERAL ORDINANCES, 2021 - KENOSHA, WISCONSIN

Business Day means a day the office of the City's Department of Public Works is routinely and customarily open for business.

Code Official means the Director of Public Works, and any duly authorized designee of the Director.

Construction Site means any area upon which one or more land-disturbing construction activities occur, including areas that are part of a larger common plan of development or sale where multiple separate and distinct land-disturbing construction activities may be taking place at different times on different schedules, but under one plan.

Department means the Department of Public Works for the City of Kenosha, Wisconsin.

Division of Land means the creation from one parcel of five (5) or more parcels or building sites of five (5) or fewer acres each in area where such creation occurs at one time or through the successive partition within a five (5) year period.

Erosion means the process by which the land's surface is worn away by the action of wind, water, ice or gravity.

Erosion and Sediment Control Plan means a comprehensive plan developed to address pollution caused by erosion and sedimentation of soil particles or rock fragments during construction.

Extraterritorial means the unincorporated area with three (3) miles of the corporate limits of a First, Second, or Third Class City, or within 1.5 miles of a Fourth Class City or village.

Final Stabilization means that all land-disturbing construction activities at the construction site have been completed and that a uniform perennial vegetative cover has been established, with a density of at least seventy (70%) percent of the cover, for the unpaved areas and areas not covered by permanent structures, or that employ equivalent permanent stabilization measures.

Governing Body means the Common Council of the City of Kenosha, Wisconsin.

Land-Disturbing Activities means any land alterations or disturbances that may result in soil erosion, sedimentation, or change in runoff, including, but not limited to, removal of groundcover, grading, excavating and filling of land.

Land-Disturbing Construction Activity means any manmade alteration of the land surface resulting in a change in the topography or existing vegetative or non-vegetative soil cover, that may result in runoff and lead to an increase in soil erosion and movement of sediment into waters of the State. Land-Disturbing Construction Activity includes clearing and grubbing, demolition, excavating, pit trench dewatering, filling and grading activities.

MEP or Maximum Extent Practicable means a level of implementing Best Management Practices in order to achieve a performance standard specified in this Chapter which takes into account the best available technology, cost effectiveness and other competing issues, such as human safety and welfare, endangered and threatened resources, historic properties and geographic features. MEP allows flexibility in the way to meet the performance standards and may vary based on the performance standard and site conditions.

Performance Standard means a narrative or measurable number specifying the minimum acceptable outcome for a facility or practice.

Permit means a written authorization made by the Code Official, or designee, to the applicant to conduct land-disturbing construction activity or to discharge post-construction runoff to waters of the State.

Pollutant means any dredged spoil, solid waste, incinerator residue, sewage, garbage, refuse, oil, sewage sludge, munitions, chemical wastes, biological materials, radioactive substance, heat, wrecked or discarded equipment, rock, sand, cellar dirt and industrial, municipal and agricultural waste discharged into water, per the meaning given in Section 283.01 of the Wisconsin Statutes, or as amended.

Pollution includes contaminating or rendering unclean or impure the waters of the State, or making the same injurious to public health, harmful for commercial or recreational use, or deleterious to fish, bird, animal or plant life, per the meaning given in Section 281.01 of the Wisconsin Statutes, or as amended.

Responsible Party means any entity holding fee title to the property or performing services to meet the performance standards of this Chapter through a contract or other agreement.

Runoff means storm water or precipitation, including rain, snow or ice melt or similar water that moves on the land surface via sheet or channelized flow.

Sediment means settleable solid material that is transported by runoff, suspended within runoff or deposited by runoff away from its original location.

Separate Storm Sewer means a conveyance or system of conveyances, including roads with drainage systems, streets, catch basins, curbs, gutters, ditches, constructed channels or storm drains, which meet all of the following criteria:

1. Is designed or used for collecting water or conveying runoff.
2. Is not part of a combined sewer system.
3. Is not draining to a storm water treatment device or system.
4. Discharges directly or indirectly to waters of the State.

Site means the entire area included in the legal description of the land on which the land-disturbing construction activity is proposed in the permit application.

Soil Stockpile means an artificially created accumulation of earth that materially affects water flow across the soil surface in a manner that is inconsistent with the permanent drainage plan.

Stop Work Order means an order issued by the Code Official, which requires that all construction activity on the site be stopped.

Technical Standard means a document that specifies design, predicted performance and operation and maintenance specifications for a material, device or method.

Waters of the State includes those portions of Lake Michigan and Lake Superior within the boundaries of this State, and all lakes, bays, rivers, streams, springs, ponds, wells, impounding reservoirs, marshes, watercourses, drainage systems and other surface water or groundwater, natural or artificial, public or private, within this State or its jurisdiction, per the meaning given in Section 281.01 of the Wisconsin Statutes, or as amended.

33.08 DESIGN CRITERIA, STANDARDS AND SPECIFICATIONS

A. BMP Design Criteria, Standards and Specifications. All BMPs required to comply with this Chapter shall meet the design criteria, standards and specifications based on the following:

1. Design guidance and technical standards identified or developed by the Wisconsin Department of Natural Resources under Subchapter V of Chapter NR 151, Wisconsin Administrative Code.
2. Design guidance and technical standards identified in the City of Kenosha Stormwater Management Criteria as developed and revised by the Director of Public Works, or his/her designee, and on file in the City Engineer's Office.
3. For purposes of this Chapter, average annual basis is calculated using the appropriate annual rainfall or runoff factor, also referred to as the R Factor, or an equivalent design storm using the 90th percentile rainfall distribution developed by the Southeastern Wisconsin Regional Planning Commission, revised 2005, and approved by the Wisconsin Department of Natural Resources, with consideration given to the geographic location of the site and period of disturbance.

B. Alternate Standards. Other technical standards not identified or developed in Subsection 33.08 A. may be used provided that the methods have been approved by the Code Official.

C. Conflict Resolution of Technical Sources. The Code Official shall approve final design criteria, standards and specifications for BMP requirements in the event of conflicts between technical sources in **Section 33.08 A.**

33.09 PERFORMANCE STANDARDS

A. Responsibility For Implementation of Plan. The responsible party shall implement an Erosion and Sediment Control Plan, developed in **Section 33.11**, which incorporates the requirements of this Section.

B. Plan. A written plan shall be developed in accordance with Section 33.11 and implemented for each construction site.

C. Erosion and Other Pollutant Control Requirements. The plan required under Section 33.11 shall include the following:

CODE OF GENERAL ORDINANCES, 2021 - KENOSHA, WISCONSIN

1. BMPs that, by design, achieve to the maximum extent practicable, a reduction of eighty (80%) percent of the sediment load carried in runoff, on an average annual basis, as compared with no sediment or erosion controls until the construction site has undergone final stabilization. No person shall be required to exceed an eighty (80%) percent sediment reduction to meet the requirements of this Section. Erosion and sediment control BMPs may be used alone or in combination to meet the requirements of this Section. Credit toward the sediment reduction shall be given for limiting the duration or area, or both, of land-disturbing construction activity, or other appropriate mechanism.

2. Notwithstanding Paragraph C.1., if BMPs cannot be designed and implemented to reduce the sediment load by eighty (80%) percent on an average annual basis, the plan shall include a written and site-specific explanation as to why the eighty (80%) reduction goal is not attainable and the sediment load shall be reduced to the maximum extent practicable.

3. Where appropriate, the plan shall include sediment controls to do all of the following to the maximum extent practicable:

- a. Prevent tracking of sediment from the construction site onto roads and other paved surfaces.
- b. Prevent the discharge of sediment as part of site dewatering.
- c. Protect the separate storm drain inlet structure from receiving sediment.

4. The use, storage and disposal of chemicals, cement and other compounds and materials used on the construction site shall be managed during the construction period, to prevent their entrance into waters of the State. However, projects that require the placement of these materials in waters of the State, such as constructing bridge footings or BMP installations, are not prohibited by this Section.

D. Location. The BMPs used to comply with this Section shall be located prior to runoff entering waters of the State.

E. Alternate Requirements. The Code Official may establish storm water management requirements more stringent than those set forth in this Section if the Code Official determines that an added level of protection is needed for sensitive resources.

33.10 EROSION CONTROL PERMITS AND ADMINISTRATION

A. Erosion Control Permits Required. No activity shall occur and no Building Permit may be issued until an Erosion Control Permit is issued by the Code Official.

B. Permit Application. The applicant must provide the following when requesting a permit:

1. A completed application form signed by the landowner. If a landowner appoints an agent to submit an application, the landowner shall be bound by all of the requirements of this Chapter and the terms of any permit issued to the agent.

2. An Erosion Control Plan meeting all the standards of the Wisconsin Department of Natural Resources (WDNR) and the Wisconsin Department of Commerce.

3. Copies of permits or permit applications or approvals required by any other governmental entity.

4. A proposed timetable and schedule for completion and installation of all elements of approved Erosion Control Plans and a detailed schedule of completion of construction.

5. Projects of a smaller scale may be allowed relief from some permit application requirements at the discretion of the Code Official.

C. Permit Approval. The Code Official shall verify that the permit application is complete. Upon approval, the Erosion Control Permit shall be issued after the applicant has met all other requirements of this Chapter.

D. Permit Conditions.

1. **Plan Implementation.** The Erosion Control Plan shall be implemented prior to the start of any land-disturbing activity and shall be maintained over the duration of the project.

2. **Permittee Responsibilities.** The permittee is responsible for the successful completion of the Erosion Control Plan. The permittee shall be liable for all costs incurred, including environmental restoration costs, resulting from noncompliance with an approved plan.

CODE OF GENERAL ORDINANCES, 2021 - KENOSHA, WISCONSIN

3. Permission To Enter Property For Inspection. Application for a permit shall constitute express permission by the permittee and landowner for the Code Official to enter the property for purposes of inspection under Section 33.08 E. of this Chapter or for curative action.

4. Adjacent Public Thoroughfares To Be Cleaned. All mudtracking off-site onto adjacent public and private thoroughfares shall be cleaned up and removed by the end of each working day or at the discretion of the Code Official using proper disposal methods.

5. Approved Permit and Erosion Control Plan Kept on Project Site. A copy of the approved permit and Erosion Control Plan shall be kept on the project site, or in a place readily accessible to contractors, engineers, inspection staff and other authorized personnel.

6. One and Two Family Erosion Control Permit Requirements. The landowner shall be responsible for construction site and erosion control maintenance and grading work at the project site, and for proper restoration in compliance with this Chapter. All items listed below shall be complied with:

a. All required drainage structures and appurtenances shall meet City specifications and approved grading and drainage plans.

b. All required ditches, swales, berms, drainage easements and waterways located within the boundary of the referenced site or within the adjacent road right-of-way and area lying adjacent to the site shall be graded to the proper gradient and side slope, and meet the approved elevations, and shall be seeded or sodded and stabilized.

c. The finished or final yard elevation and slope around the perimeter of any new structure, along with the entire site area, shall be final graded and finished with topsoil and seeded or sodded to the required elevations as shown on the approved Building Permit Plat of Survey as submitted at the time of Building Permit issuance. If seeded, the parkway, a ten (10) foot perimeter along any public sidewalk or right-of-way, and any drainageway, including downspout channels, shall be protected by erosion control matting or other approved method.

If a structure or project is completed between September 15 and May 1 of any given year, the site may be rough graded so as to prevent runoff, and erosion control measures are to be installed and maintained until the site can be final graded and stabilized, but in no case later than June 1 of the following year.

d. All roof drainage and sump pump discharge shall be outletted to the street yard, natural drainageway or approved storm sewer system so as not to saturate, accumulate or damage the subject property or adjacent properties.

e. Gutters and downspouts, or roof leaders and downspouts, shall be installed on all principal structures in order to direct water runoff away from the structures to the street yard, natural drainageway or approved storm sewer system.

f. The site shall be cleared of rubbish, brush and any other debris. Construction materials, other unused materials, clay or fill piles shall be removed from the site.

g. A Plat of Survey prepared by a Wisconsin registered land surveyor or Wisconsin licensed professional engineer shall be submitted showing proposed elevations as approved by the City, and actual final elevations in the following locations:

(1) At the property corners and at all corners of the structures.

(2) At twenty-five (25) foot intervals along each property line.

E. Permit Duration. Permits issued under this Section shall be valid for a period of one hundred eighty (180) days from the date of issue, or for the pendency of the Building Permit or other construction authorizations, whichever is longer.

F. Extensions of Time To Complete Work. Any applicant who obtains a permit and fails to complete the work in the time specified in Subsection 33.10 E., may apply to the Code Official for a time extension not to exceed one (1) year. Extensions may be granted if the work commenced has proceeded in a professional and workmanlike manner which exhibits reasonably progress. Extended permits shall not impose new conditions unless required by this Ordinance, or any other State or local law, rule or regulation. In the event that the Code Official denies the request for extension, such denial may be appealed to the Stormwater Utility Committee. Such appeal must be filed in the office of the City Clerk/Treasurer within thirty (30) days of the denial. There is no fee for this appeal. Upon a violation of

Subsection 33.10 E., no new work may commence without the issuance of an approved extension or a new permit.

G. Cash Assurance. At the time a preliminary grading or mass grading Erosion Control Permit is issued to any project involving one (1) or more acres of land-disturbing construction activity, the landowner shall submit a payment of Five Thousand (\$5,000.00) Dollars to guarantee that the conditions of the Erosion Control Permit and this Chapter are being followed as they relate to maintaining the public right-of-way and storm sewer system. The cash assurance shall be used if the City determines that the landowner or his/her contractor have not kept the right-of-ways clean from mudtracking, if there is damage to the stormwater drainage improvements, or if erosion and sediment controls are not being maintained. If the cash assurance is depleted prior to completion of the project, the landowner shall post another cash assurance in the same amount. The cash assurance shall be refunded to the landowner once the project is completed and it is determined that the property is in compliance with this Chapter.

H. Soil Stockpiles.

1. Review and Approval Required. Soil stockpiles are permitted only when reviewed and approved as part of an Erosion Control Permit for site mass grading or new building construction, or other approved land-disturbing activities.

2. Location. Soil stockpiles shall not be located in close proximity to any public street or alley, and in all cases shall be located as indicated on the approved plan. Requested changes of location shall require a revised plan and approval of the Code Official.

3. Removal. All soil stockpiles shall be removed from the site or graded to meet the approved drainage plan at the time the permit expires, or at the time a Temporary Occupancy Permit is issued to any project connected with that particular site, whichever occurs sooner.

I. Project Site Maintenance.

1. Responsibility of Landowner. It shall be the responsibility of the landowner to maintain the project site and adjoining right-of-way in conformance with the following:

a. Free from debris, rubbish, unused building materials, scraps, etc. All such materials shall be collected in a covered dumpster or other approved container.

b. Grass, weeds and vegetation shall not exceed a height of eight (8") inches.

2. Failure To Comply With Order(s). In the event that the responsible party fails to comply with an order to clean the site or to cut grass, weeds or vegetation, the Code Official may have the work done, and shall recover the cost through special assessments levied against the property. A One Hundred (\$100.00) Dollar Administrative Fee for processing and administering the special assessment shall be added to the special assessment against the property.

J. Inspections.

1. Implied Consent. Application for a permit shall constitute permission by the applicant and landowner for the Code Official, or his/her designee, to enter upon the property and inspect during the construction phase prior to the inspections, as may be deemed necessary to confirm compliance with the requirements of this Chapter.

2. Number of Inspections. The site of any regulated land disturbing activity shall be inspected once every thirty (30) days, or more frequently as determined by the Code Official during the construction phase.

3. Compliance Verification. Within ten (10) days after installation of all practices in an approved Erosion Control Plan and achievement of soil stabilization, the permittee shall notify the Code Official. The Code Official shall inspect the property to verify compliance with the Erosion Control Plan within ten (10) days of notification of soil stabilization.

4. Maintenance. Maintenance, as outlined in Commerce 21.125 and Commerce 60.20, Wisconsin Administrative Code, is the responsibility of the owner, and facilities are subject to inspection and orders for repair.

K. Permit Transfers.

1. Approval. When a permittee and landowner act to transfer an interest in property subject to an approved plan prior to the completion of the proposed steps to attain soil stabilization, the permittee must

secure approval from the Code Official.

2. Responsibility To Comply With Minimum Standards. When a permittee and landowner transfer ownership, possession or control of real estate subject to either or both an uncompleted Erosion Control Plan, the successor in interest to any portion of the real estate shall be responsible to control soil erosion and runoff and shall comply with the minimum standards provided in this Chapter.

L. Plan or Permit Amendments. Any proposed modifications to approved plans, construction schedules or alterations to accepted sequencing of land disturbing site activities shall be approved by the Code Official in consultation with the plan review agency prior to implementation of said changes.

33.11 EROSION AND SEDIMENT CONTROL PLAN, STATEMENT AND AMENDMENTS

A. Erosion and Sediment Control Plan.

1. An Erosion and Sediment Control Plan shall be prepared and submitted to the Code Official.
2. The Erosion and Sediment Control Plan shall be designed to meet the performance standards in Section 33.09 and other requirements of this Chapter.
3. The Erosion and Sediment Control Plan shall address pollution caused by soil erosion and sedimentation during construction and up to final stabilization of the site. The Erosion and Sediment Control Plan shall include, at a minimum, the following items:
 - a. The name(s) and address(es) of the owner or developer of the site, and of any consulting firm retained by the applicant, together with the name of the applicant's principal contact at such firm. The application shall also include start and end dates for construction.
 - b. Description of the site and the nature of the construction activity, including representation of the limits of land disturbance on a United State Geological Service 7.5 minute series topographic map.
 - c. A sequence of construction of the development site, including stripping and clearing; rough grading; construction of utilities, infrastructure, and buildings; and final grading and landscaping. Sequencing shall identify the expected date on which clearing will begin, the estimated duration of exposure of cleared areas, areas of clearing, installation of temporary erosion and sediment control measures, and establishment of permanent vegetation.
 - d. Estimates of the total area of the site and the total area of the site that is expected to be disturbed by construction activities.
 - e. Estimates, including calculations, if any, of the runoff coefficient of the site before and after construction activities are completed.
 - f. Calculations to show the expected percent reduction in the average annual sediment load carried in runoff as compared to no sediment or erosion controls.
 - g. Existing data describing the surface soil as well as subsoils.
 - h. Depth to groundwater, as indicated by Natural Resources Conservation Service soil information, where available.
 - i. Name of the immediate named receiving water from the United States Geological Service 7.5 minute series topographic maps.
 - j. For building construction sites, the following shall also be required:
 - (1) Property lines, lot dimensions and limits of disturbed areas.
 - (2) Limits of impervious area, including buildings. Include all public and private roads, interior roads, driveways and parking lots, and indicate the type of paving and surfacing material.
 - (3) Cross-sections of and profiles of channels, swales and road ditches.
 - (4) Culvert sizes, if applicable.
 - (5) Direction of flow of runoff.
 - (6) Design discharge for ditches and structural measures.
 - (7) Runoff velocities.
 - (8) Fertilizer and seeding rates and recommendations, if applicable.
 - (9) Time schedules for stabilization of ditches and slopes.
 - (10) Description of methods by which sites are to be developed and a detailed land disturbance

CODE OF GENERAL ORDINANCES, 2021 - KENOSHA, WISCONSIN

schedule, including time schedules for stabilization of ditches and slopes.

(11) Provision for sequential steps mitigating erosive effect of land disturbing activities to be followed in appropriate order and in a manner consistent with accepted erosion control methodology suitable to proposed sites and amenable to prompt revegetation, including runoff calculations as appropriate.

(12) Provisions to prevent mudtracking off-site onto public thoroughfares during the construction period.

(13) Provisions to disconnect impervious surfaces, where feasible.

(14) Provisions to prevent sediment delivery to and accumulation in any proposed or existing stormwater conveyance systems.

(15) Copies of permits or permit applications required by any other unit of government or agency.

(16) Existing and proposed elevations, and existing and proposed contours in the area, where deemed necessary.

(17) Any other information necessary to reasonably determine the location, nature and condition of any physical or environmental features of the site.

(18) Soil storage piles and length of time to be left undisturbed.

(19) Basin and retention area stabilization details.

4. Plan Checklists shall be reviewed by the Code Official for completeness and accuracy.

5. All Best Management Practices (BMPs) shall be designed to meet the criteria identified by or developed by the Wisconsin Department of Natural Resources as set forth in Chapters NR 151, Commerce 20-21 and Commerce 60-65, Wisconsin Administrative Code. In addition, the Wisconsin Department of Transportation Erosion Control Product Acceptability List (WIS DOT PAL) may be used as a reference.

6. The Erosion and Sediment Control Plan shall include a site map. The site map shall include the following items and shall be at a scale not greater than two hundred (200') feet per inch and at a contour interval not to exceed five (5') feet.

a. Existing topography, vegetative cover, natural and engineered drainage systems, roads and surface waters. Lakes, streams, wetlands, channels, ditches and other watercourses on and immediately adjacent to the site shall be shown. Any identified one hundred (100) year flood plains, flood fringes and floodways shall also be shown.

b. Boundaries of the construction site.

c. Drainage patterns and approximate slopes anticipated after major grading activities.

d. Areas of soil disturbance.

e. Location of major structural and non-structural controls identified in the plan.

f. Location of areas where stabilization practices will be employed.

g. Areas which will be vegetated following construction.

h. Areal extent of wetland acreage on the site and locations where stormwater is discharged to a surface water or wetland.

i. Locations of all surface waters and wetlands within one (1) mile of the construction site.

j. An alphanumeric or equivalent grid overlying the entire construction site map.

7. Each Erosion and Sediment Control Plan shall include a description of appropriate controls and measures that will be performed at the site to prevent pollutants from reaching the waters of the State. The plan shall clearly describe the appropriate control measures for each major activity and the timing during the construction process that the measures will be implemented. The description of erosion controls shall include, when appropriate, the following minimum requirements:

a. Description of interim and permanent stabilization practices, including a practice implementation schedule. Site plans shall ensure that existing vegetation is preserved where attainable and that disturbed portions of the site are stabilized.

b. Description of structural practices to divert flow away from exposed soils, store flows or otherwise limit runoff and the discharge of pollutants from the site. Unless otherwise specifically approved in writing by the Code Official, structural measures shall be installed on upland controls.

c. Management of overland flow at all sites, unless otherwise controlled by outfall controls.

- d. Trapping of sediment in channelized flow.
- e. Staging construction to limit bare areas subject to erosion.
- f. Protection of downslope drainage inlets where they occur.
- g. Minimization of tracking at all sites.
- h. Cleanup of off-site sediment deposits.
- i. Proper disposal of building and waste materials at all sites.
- j. Stabilization of drainageways.
- k. Control of soil erosion from dirt stockpiles.
- l. Installation of permanent stabilization practices as soon as possible after final grading.
- m. Minimization of dust to the maximum extent practicable.

8. The Erosion and Sediment Control Plan shall require that velocity dissipation devices be placed at discharge locations and along the length of any outfall channel, as necessary, to provide non-erosive flow from the structure to a watercourse so that the natural physical and biological characteristics and functions are maintained and protected.

B. Erosion and Sediment Control Plan Statement. For each construction site identified under Section 33.04, an Erosion and Sediment Control Plan statement shall be prepared. This statement shall be submitted to the Code Official. The control plan statement shall briefly describe the site, including a site map. Further, it shall also include the best management practices that will be used to meet the requirements of the Chapter, including the site development scheduled.

C. Amendments. The applicant shall amend the plan if any of the following occur:

- 1. There is a change in design, construction, operation or maintenance at the site which has the reasonable potential for the discharge of pollutants to waters of the State and which has not otherwise been addressed in the plan.
- 2. The actions required by the plan fail to reduce the impacts of pollutants carried by the construction site runoff.
- 3. The Code Official notifies the applicant of changes needed in the plan.

33.12 FEE SCHEDULE

The fees referred to in other sections of this Chapter shall be established by Resolution of the Common Council, and may from time to time be modified by Resolution. A schedule of fees established by the Common Council shall be available for review in the Department of City Inspections.

33.13 INSPECTION

If land-disturbing construction activities are being carried out without a permit required by this Chapter, the Code Official may enter the land pursuant to the provisions of Sections 66.0119(1), (2), and (3) of the Wisconsin Statutes.

33.14 VIOLATIONS AND ENFORCEMENTS

A. Reinspection Fees. A Reinspection Fee may be assessed when any of the following occur:

- 1. An inspection is requested by the owner, owner's agent or contractor, and the Work is not completed.
- 2. An inspection is requested by the owner, owner's agent or contractor, and there is no access to the Premises.
- 3. After an initial inspection and notice of violation(s) to be corrected, an inspection is requested by the owner, owner's agent or contractor to approve corrections, and those corrections are incomplete or only a portion of the corrections are made, or corrections have been ignored, and previous arrangements have not been made with the Code Official to accomplish ordered corrections in phases, a Reinspection Fee shall be imposed on the owner, owner's agent or contractor responsible for the inspection request.

Work may not proceed on the installation impacted until such time that said Reinspection Fee has been paid.

CODE OF GENERAL ORDINANCES, 2021 - KENOSHA, WISCONSIN

There shall be no Reinspection Fee for a final inspection to determine compliance, or for a reinspection occurring during a period of an approved time extension granted for good cause and involving a good faith effort on the part of the property owner.

A fee of Ninety (\$90.00) Dollars may be charged for a second reinspection; a fee of One Hundred Eighty (\$180.00) Dollars may be charged for a third reinspection; and, a fee of Three Hundred Sixty (\$360.00) Dollars may be charged for each subsequent reinspection. Reinspection Fees which are not paid for by or on behalf of the property owner within thirty (30) days of mailing of an invoice to the Permit holder shall be charged and collected as a special assessment against the real estate upon which the reinspection was made, and shall be a lien upon the real estate until paid in full, with interest accruing on the unpaid balance at the rate of seven (7%) percent per annum. There shall also be an administrative fee in the amount of One Hundred (\$100.00) Dollars added to the charge to cover the administrative costs of charging and specially assessing the property.

B. Stop Work Order.

1. Whenever the Code Official finds any noncompliance with the provisions of this Chapter, the Code Official shall attempt to communicate with the owner or person performing the work to obtain immediate and voluntary compliance if such person is readily available. If the owner or person performing the work is not readily available, that person refuses to voluntarily comply immediately, or the noncompliance presents an immediate danger or threatens to cause bodily injury or damage to off-site property, including, but not limited to, off-site runoff, the Code Official shall post in a conspicuous place on the premises, a Stop Work Order, which shall cause all activity not necessary to correct the noncompliance to cease until noncompliance is corrected.

2. The Stop Work Order shall provide the following information:

- a. Date of issuance;
- b. Reason for posting; and,
- c. Signature of inspector posting the Order.

3. In addition to posting a Stop Work Order, the Code Official shall provide written notification to the owner or contractor by personal service, certified mail, electronic mail or facsimile transmission. The permittee, landowner and contractor shall have twenty-four (24) hours from time of notification by the Code Official to correct any noncompliance with the plan when notification is by either personal communication of noncompliance to the owner or contractor, or their respective agents, or written notice sent by certified mail to the owner or contractor.

If notice is not provided under this subsection, the permittee and landowner shall have seventy-two (72) hours to correct any noncompliance with the plan when notification is by posting notice in a conspicuous place on the site or sending notice by facsimile transmission to the owner or contractor.

4. If the noncompliance is not corrected within the time periods specified in Section 33.12 A.3., the permittee and landowner authorize the Code Official to take any action, to perform any work, or commence any operations necessary to correct noncompliance on the subject property where notice of noncompliance has been issued to bring the property into conformance with plan requirements. The permittee and landowner further consent to reimburse the authority for the total costs and expenses of the corrective actions. Reimbursement may be collected as a special charge upon the property for current services rendered as provided by law.

5. If the responsible party does not cease activity as required in a Stop Work Order posted under this Section or fails to comply with the Erosion and Sediment Control Plan or permit conditions, the Code Official may revoke the permit.

6. If the responsible party, where no permit has been issued, does not cease the activity after being notified by the Code Official, or if a responsible party violates a Stop Work Order posted under Subsection B.1., the Code Official may request that the City Attorney seek an injunction in any court of competent jurisdiction.

C. Penalties. Any person violating any of the provisions of this Code, except for the provisions governing the administration or enforcement thereof, shall upon conviction be subject to a forfeiture of not less than Twenty-five (\$25.00) Dollars per day, nor more than Five Hundred (\$500.00) Dollars per day, together with the costs of prosecution; and, in default thereof, shall be imprisoned for a period of not less than one (1) day, nor more than six (6) months in the County Jail, or until such forfeitures and costs are

paid.

33.15 APPEALS

A. Committee on Public Works. The Committee on Public Works, with respect to this Code:

1. Shall hear and decide appeals where it is alleged that there is error in any order, decision or determination made by the Code Official in administering this Code.

2. May authorize variances from the provisions of this Code which are not contrary to the public interest and where, owing to special conditions, a literal enforcement of the provisions of this Code will result in unnecessary hardship.

3. Shall use the rules, procedures, duties and powers authorized by Wisconsin Statutes in hearing and deciding appeals and authorizing variances.

B. Appeals. Appeals to the Committee on Public Works may be made in writing by any aggrieved person or by any officer, department, Authority, Board or Commission of the City affected by a decision of the Code Official.

C. Appeal Filing Fee. There shall be a One Hundred (\$100.00) Dollar fee to accompany the filing of an appeal.

33.16 SEVERABILITY

If a court of competent jurisdiction judges any section, clause, provision or portion of this Chapter unconstitutional or invalid, the remainder of the Chapter shall remain in force and not be affected by such judgment.

CHAPTER XXXIV
FORESTRY

- 34.01 Intent And Purpose
- 34.02 Definitions
- 34.03 City Forester
- 34.04 Forestry Permit
- 34.05 Regulations Respecting Trees In Lawn Parks And Public Right-Of-Ways
- 34.06 Public Nuisance-Private Premises
- 34.07 Permit Revocation
- 34.08 No Guarantee, Warranty Or Causes Of Action Created
- 34.09 Injury To Trees Prohibited
- 34.10 Tree Protection
- 34.11 Enforcement
- 34.12 Administrative Remedies
- 34.13 Appeals
- 34.135 Special Assessments
- 34.14 Penalty

34.01 INTENT AND PURPOSE

It is hereby declared to be the policy of the City of Kenosha to regulate trees in the City in order to promote the public health, safety and welfare, enhance aesthetics and reduce the potential for trees becoming public nuisances.

Trees are a valuable resource which enhance the aesthetics of the property, prevent soil erosion, filter airborne pollutants, reduce atmospheric carbon dioxide, produce oxygen and ameliorate harsh climates, thereby reducing energy consumption. In addition, trees contribute significantly to property values and provide many other benefits from a local to a global aspect.

34.02 DEFINITIONS

Whenever the following words or terms are used in this Ordinance, they shall be construed to have the following meanings:

- A. "**Person**" shall mean any person, firm, association or corporation.
- B. "**City**" shall mean the City of Kenosha, Wisconsin.
- C. "**Commission**" shall mean "The Board Of Park Commissioners" as constituted under the Code of General Ordinances of the City of Kenosha.
- D. "**Public Right-of-Ways**" shall include that part of every street between the lot line and the curb, pavement or street line and shall include sidewalks and lawn parks.
- E. "**Public Property**" shall include all public right-of-ways, City lawn parks, boulevards, parks and other lands owned, controlled or leased by the City.
- F. "**Public Trees**" shall mean any trees located or to be planted in or upon any public property.
- G. "**Private Property**" shall mean all lands not owned, controlled or leased by the City.
- H. "**Private Trees**" shall mean any trees located or to be planted in or upon private premises.
- I. "**Protected Trees**" shall mean a tree which has a diameter, measured at fifty-four (54") inches from grade, of three (3") inches or greater.
- J. "**Public Nuisance**" shall mean any tree or part thereof which by reason of its condition interferes with the use of any public area; or which is infected with a plant disease; or which is infested with injurious

insects or pests which threaten public or private property, or which endangers the public health, safety and welfare.

K. "Forestry Program" shall mean a comprehensive plan including maintenance, inventory and new planting with budget projections for annual and long range implementation.

L. "Visual Clearance" shall be defined as provided for in §2.06 of the Zoning Ordinance of the City of Kenosha entitled "Visual Clearance".

M. "Lawn Park" shall have the meaning provided in §5.051 of the Code of General Ordinances.

N. "Tree", for purposes of controlling a public nuisance or regulating public property, shall include shrubs.

O. "Replacement Tree" shall mean a tree which replaces a tree in the location where a tree has been removed.

34.03 CITY FORESTER

The City may employ a City Forester, or designate a City employee to perform the duties thereof, who, under the supervision of the Superintendent of Parks, and Commission, shall exercise designated powers and duties. City Forester shall include designees thereof.

A. Powers And Duties.

1. Exercise the powers conferred in §27.09, Wisconsin Statutes.
2. Administer and enforce this Ordinance.
3. Prepare an annual Forestry Program to be submitted to the Director of Public Works and Park Commission, and implement such Program, as adopted and amended from time to time.
4. Supervise subordinates, oversee other employees and administer contracts related to the Forestry Program and this Ordinance.
5. Conduct or authorize inspections, tests, planting, replacements, pruning, removal, spraying, maintenance and issue permits as necessary to implement the Forestry Program and this Ordinance. Inspections of private property shall be at reasonable times with the consent of the owner or person in charge or by Special Inspection Warrant.
6. Prepare a Forestry Plan to be submitted to the Director of Public Works and Park Commission and implement such Program, as adopted and amended from time to time.
7. Assist any person, having a permit to move a building, structure or oversized load upon a public right-of-way, in selecting a route which will cause minimal potential damage to trees.
8. Promulgate written guidelines for permitted work, to be filed in the Department of Public Works.

B. City Forestry Plan. The City Forester, under the direction of the Director of Public Works and Park Commission, shall prepare a Forestry Plan which shall include one or more of the following programs:

1. A City Lawn Park Beautification Program to provide for tree plantings and replacement in lawn parks. This Program is to be established on a quarter-section area basis or other acceptable, divisional plan covering a ten (10) year period. Said Program shall provide for the cost of tree planting to be borne jointly by the abutting property owner and the City, as determined by the Commission.
2. A City Tree Planting Program to provide that whenever a bond issue is passed for the purpose of replacing and/or widening any City street, that there be included within such bond issue sufficient funds to carry out a tree planting program to replace any trees destroyed or damaged in the course of making the improvement.

34.04 FORESTRY PERMIT

A. Permit Requirement And Cost. No person shall plant, replace, prune, alter, do surgery on a

tree, on any limbs greater than one and one-half (1-1/2") inches in diameter, or disturb the land within the dripline of any tree on lawn parks and public right-of-ways, or cause such work to be done by others, without first obtaining a written permit for such work from the City Forester, as herein provided. The permit holder shall be responsible for paying for the cost of all work performed, unless acting under contract with the City or its subunits.

B. Permit Exemptions. No person shall be required to obtain a Permit to fertilize or water trees in a lawn park abutting their property. No person shall be required to obtain a permit to prune limbs of one and one-half (1-1/2") inches or less in diameter on trees in a lawn park or public right-of-way abutting their property.

C. Permit Application. Any person who applies for a Permit shall make said application in writing, on City forms.

D. Permit Issuance, Fee And Term. When the City Forester determines that any proposed work described in an application for a Permit is in accordance with the provisions of this Ordinance, taking into account the public health, safety and welfare, the location of utilities above and below ground, public sidewalks, driveways, street lights and signs, the general character of the area in which the tree is located or proposed to be located, the type of soil, the characteristics and physiological need of the genus, species and variety of the tree, then a Permit may be issued or denied as appropriate under the circumstances, with conditions or limitations, without a fee therefore.

E. Permit And Duration. Every Permit issued by the City Forester shall include a description of the work to be done and shall specify, in the case of plantings, the genus, species and variety, size, nursery grade and location of trees to be planted. Any work done under such Permit issued under this Section shall expire nine (9) months after the date of issuance.

F. Permit Violation. It shall be a violation of this Ordinance for any person to perform work under a Permit contrary to the Permit terms and provisions of this Ordinance.

A Permit violator shall be responsible for the repair and replacement of any tree damaged or destroyed due to defective work or noncompliance with this Ordinance for two (2) full growing seasons following performance of work.

G. Annual Public Utility And Contractor Permits. Public utilities and contractors may apply for and obtain, in accordance with this Ordinance, an Annual Forestry Permit subject to the following additional conditions, unless waived for just cause by the City Forester:

1. Provide City Forester with fifteen (15) days advance, written notice of work to be performed.
2. Perform work in conformance with this Ordinance and written guidelines and directives of the City Forester.

34.05 REGULATIONS RESPECTING TREES IN LAWN PARKS AND PUBLIC RIGHT-OF-WAYS

The following regulations respecting trees in lawn parks and public right-of-ways shall apply, unless a variance is granted for just cause by the City Forester:

A. Genus, Species, Variety, Size And Manner Of Planting. The City Forester shall approve the genus, species, variety, size and manner of planting of trees planted in any lawn park or public right-of-way.

B. Minimum Size. The minimum size of any tree planted in a lawn park or public right-of-way shall be one and one-half (1-1/2") inches in diameter measured at six (6") inches above the ground.

C. Distance Limitations. No tree shall be planted in a lawn park or public right-of-way within thirty (30') feet of a street corner, street light, traffic sign, traffic signal, or within forty (40') feet of another tree located in the lawn park or public right-of-way. Trees may be authorized to be planted in a lawn park or public right-of-way which is less than four (4') feet in width, measured from the sidewalk to the back of the curb. The species and site location will be determined by the City Forester or his/her designee prior to planting a tree. No more than one (1) tree shall be planted in a lawn park or public right-of-way abutting a lot having a frontage at the street of less than one hundred twenty (120') feet.

D. Required Pruning. Trees planted within any lawn park or public right-of-way shall be trimmed so that any branches or foliage projecting over any public right-of-way which is the subject of vehicular traffic provide a clearance of not less than thirteen and one-half (13-1/2') feet from the pavement and any branches or foliage projecting over any public right-of-way which is the subject of pedestrian traffic provide a clearance of not less than eight and one-half (8-1/2') feet from the pavement or ground. Trees shall be pruned in such a manner as to preserve their health and maintain a natural shape.

E. Visual Clearance. Visual clearance shall be maintained.

F. Tree Removal. Trees which are cut down shall be removed with the root stump grubbed or ground out to a depth at least nine (9") inches below grade. Surface roots beyond the main stump are to be removed to a depth at least five (5") inches below grade. All wood and debris shall be removed from the site and no wood or debris shall be permitted to remain on the street or sidewalk when work on any day is concluded. Holes must be safeguarded by a barricade if not immediately filled. The abutting property owner shall fill holes as soon as practicable, which shall be topped with a minimum of two (2") inches of top soil and seeded. The site shall be barricaded to protect the public at any time work is in progress. A permit to an abutting property owner to remove a lawn park tree, having a diameter in excess of six (6") inches measured fifty-four (54") inches from grade, shall be conditioned upon proof of liability insurance covering death and personal injury and property loss or damage in the amount of Two Hundred Fifty Thousand (\$250,000) Dollars.

G. Tree Replacement. Irrespective of the foregoing distance limitations, a replacement tree may be planted in any lawn park or public right-of-way subject to the permitting requirements of Section 34.04.

H. Sidewalks. Sidewalks, paving and other surfaces impervious to water shall not be constructed within two (2') feet of the base of any tree.

I. Roots. Roots greater than two (2") inches in diameter shall not be severed without the permission of the City Forester.

J. Boring. Boring shall be done under a tree only when necessary, and at a minimum depth of thirty (30") inches below grade to avoid the roots of trees.

K. Sidewalk Excavation. Sidewalk excavation shall be allowed to a maximum depth of six (6") inches.

L. Curb Excavation. Curb excavation shall be allowed to a maximum depth of eighteen (18") inches.

M. Notice Of Planting And Removal. Whenever the City Forester proposes the planting or removal of any tree, he/she shall give two (2) weeks advance written notice to the owner of record or person in

charge of the lot or parcel of land adjacent to the land on which such tree stands or will stand. Said written notice shall advise that written, detailed objections may be sent or served upon the City Forester within said two (2) week period. Said notice shall specify in detail the street, avenue or boulevard from which trees are proposed to be planted or removed and the general nature and character of the changes and improvement contemplated. After reviewing any written objections which may be submitted, the City Forester will advise the owner of record or person in charge of the lot or parcel of land adjacent to the land on which the tree stands or will stand, in writing, of his/her final decision regarding the tree. The City Forester shall abandon or modify said proposed work or proceed with it as he/she believes the best interest of the public requires. No prior notices by the City Forester are required for the trimming of living trees or for the removal of dead or dangerous trees. The absence of a timely notice shall not render any work performed invalid.

N. Appeal. The final written order of the City Forester may be appealed to the Commission upon written notice of appeal to the City Forester, served or postmarked within ten (10) days of said written order. Where possible, said appeal will be heard at the next scheduled meeting of the Commission, provided that the notice of appeal is received by the City Forester at least seven (7) days prior to the next scheduled meeting of the Commission.

O. Sanitary Sewers Clogged With Tree Roots. Abutting property owners shall be responsible for cleaning and repairing sanitary sewer laterals which are clogged with the roots from lawn park trees. The abutting property owner, when performing any work within the dripline of a healthy tree, shall take such measures as directed by the City Forester to protect trees from injury and damage, up to and including tunneling.

34.06 PUBLIC NUISANCE-PRIVATE PREMISES

A. Notice to Abate Public Nuisance. Whenever the City Forester shall find that any tree or part thereof growing or located upon private property is a public nuisance, he/she shall notify the owner thereof, in writing, that the nuisance must be abated as directed in the notice within the time specified, which time shall not be less than thirty (30) days, unless the City Forester shall determine that immediate action is necessary to preserve the public health, safety and welfare, in which event a lesser period of time for abatement shall be provided.

Notice shall be served on the owner of record of said lot identifying those conditions which constitute a public nuisance and demanding abatement by a time certain in the manner and to the extent prescribed by said notice. Service shall be in the manner provided for service of a Summons in the Circuit Court or by Certified Mail-Return Receipt. If the owner cannot be served or if there is no Certified Mail-Return Receipt, the order may be served by posting it on the main entrance of the building or structure, if any, or where no building or structure is present, by posting a sign on each side of said lot, and by publishing as a Class One (1) Notice, under Chapter 985, Wisconsin Statutes.

B. Failure To Abate. If said owner fails to remedy or improve the condition complained of in accordance with the written notice furnished by the City Forester, then said City Forester shall, after the expiration of the period specified in the written notice, cause said nuisance to be abated.

C. Abatement By City. The abatement may be by City personnel or by a contractual agreement with others entered into by the City.

D. Hearing. The owner, upon written request to the City Forester, served and postmarked during the notice period, shall be granted a hearing before the City Forester. Where possible, said hearing should be within ten (10) days following the request therefor. Said hearing shall give the owner the opportunity to contest the existence of facts sufficient to form the basis for the finding of a public nuisance as herein

described. Following the hearing, a written statement of the findings of the City Forester shall be sent by regular mail to the owner at the address given by the owner at said hearing. The City Forester may, for good cause, extend the period of time for abatement of the nuisance.

E. Appeal. The written order of the City Forester, where a hearing has been held, may be appealed to the Commission upon written request to the City Forester, served or postmarked within ten (10) days of the date of said written order. Where possible, said appeal should be heard at the next scheduled meeting of said Commission, provided that the request for review is received by the City Forester at least seven (7) days prior to the next scheduled meeting of the Commission.

F. Special Assessment. Following abatement of said public nuisance, the City Forester shall bill the owner for the cost of abatement. If such bill is not paid within thirty (30) days, said bill shall be processed as a special assessment against said property.

G. Emergency Procedure. The above specified notice procedure does not apply when circumstances arise which require immediate action to protect the public from imminent harms, such as sickness, disease or personal injury. In determining imminent harm, there must be a balancing of the rights of the landowner to notice and appeal procedures with the right of the public to be protected from a risk of harm which could be avoided by prompt action. However, where possible, the landowner should be given a minimum of twenty-four (24) hours written or oral notice prior to City abatement action. The above Ordinance shall otherwise apply, except for the notice and appeal procedures, which shall be as herein stated.

34.07 PERMIT REVOCATION

Any Permit granted under authority of this Ordinance may be revoked by the City Forester for cause upon ten (10) days advance, written notice and an opportunity to be heard. The revocation of any Permit may be appealed to the Commission within ten (10) days of receipt of written notice of revocation.

34.08 NO GUARANTEE, WARRANTY OR CAUSES OF ACTION CREATED

This Ordinance is not intended to guarantee or to expressly or impliedly warrant to any person that this Ordinance will accomplish its intended purpose, especially in regard to private trees, and no causes of action are intended to be created or vested in any person either against the City or against any other party.

34.09 NJURY TO TREES PROHIBITED

A. No person, upon public property, shall:

1. Injure, destroy, damage, mutilate, deface or commit any act which will prevent the growth or cause the death of any tree.
2. Secure, attach, fasten, nail or run through any rope, cable, wire, sign or fixture to, around or through any tree.
3. Deposit, place or permit the deposit of any toxic or hazardous substance on or about any tree.
4. Excavate or disturb the ground within the dripline of any tree without a permit.
5. Perform any work within the dripline of any tree without taking measures as directed by the City Forester to protect the tree from injury and damage, up to and including tunneling.
6. Remove any guard, stake or other protective device or close or obstruct any open space about the base of a tree designed to permit access of air, water or fertilizer.
7. Perform any other act contrary to this Ordinance.

34.10 TREE PROTECTION

A. Application. This Ordinance, except as otherwise provided, shall be applicable to lots and parcels of land which are:

1. Twenty thousand (20,000) square feet or greater; or,
2. Subject to a Conditional Use Permit; or,
3. Subject to a Subdivider's Agreement; or,
4. Zoned B-2 or IP;

and which contain a protected tree.

This Ordinance shall not apply to the construction of garages and additions to dwellings located on residential lots improved with a dwelling.

B. Prohibition. No person shall perform any act requiring a Permit in this Ordinance without first obtaining a Permit or perform any action pursuant to a Permit contrary to the terms, conditions and limitations of such permit or otherwise violate any provision of this Ordinance.

1. Permit Required. Any person, party, firm or corporation to whom this Ordinance applies, except as herein provided, shall not remove a protected tree, build or construct any building or structure upon a lot or parcel containing a protected tree, or otherwise disturb the land upon a lot or parcel containing a protected tree without first obtaining a permit hereunder. A permit is not required where a development is regulated by a Subdivider's Agreement or Conditional Use Permit, where the Tree Protection provisions of this Ordinance are incorporated therein.

A permit shall not be required by government personnel or agencies who remove a tree in the performance of their official duties during an emergency declared by the Mayor or Common Council.

The owner of any regulated lot or parcel of land who claims an exemption from this permitting requirement for reason of there being no protected tree on said lot or parcel shall, as a condition of exemption, file an executed statement to this effect with the permitting authority.

2. Application Form And Filing. Permit application shall be made to the City Forester in the Department of Public Works upon City forms. Where an application is made for a Building Permit, the Tree Protection Permit application may be combined with the Building Permit application, and filed with the Department of City Inspections for forwarding to the City Forester. Where the lot or parcel of land contains a tree which has a diameter measured at fifty-four (54") inches from grade of three (3") inches or greater, the application shall include a tree location survey to include the following on a scale of 50:1 or larger:

a. Location, shape and dimensions of the lot or parcel, existing and proposed locations of buildings, utilities and other improvements, if any.

b. Location of all existing trees, which are subject to this Ordinance, identifying the tree diameter measured at fifty-four (54") inches from grade. Trees proposed to remain, to be transplanted, or to be removed, shall be identified as such. Groups of trees which are fifteen (15') feet or more in distance from any land disturbing activity may be designated as a "clump" of trees, with the estimated number and average size listed. All trees shall be numbered on the plan.

c. Where existing trees are to be transplanted, the proposed relocation for such trees, together with a statement as to how such trees are to be transplanted, protected during land clearing and building construction and maintained after construction, is required.

d. A statement indicating how trees not proposed for removal or relocation are to be protected during land clearing and building construction.

e. Locations and dimensions of all setbacks and easements required by the City of Kenosha Zoning Ordinance or Subdivider's Agreement.

f. Grade changes proposed for each lot or parcel of land and a statement showing how such changes will affect trees protected by this Ordinance.

g. Location of trees to be planted.

h. Approved landscape plan, if any is required by another Ordinance, to be attached.

The above data may be combined, as practical, into as many documents as will fulfill the requirement.

Where no protected tree is located upon the lot or parcel of land, a request for a "No Tree Verification" shall be submitted in lieu of a tree location survey.

3. Time Of Permit Issuance. Permit issuance shall be governed by the following timeframes:

a. Where a construction activity requires a City approved landscape plan, following landscape plan approval.

b. Where a construction or land disturbing activity requires an Erosion Control Permit, following the issuance of the Permit.

c. Where a construction activity requires a Building Permit, prior to the issuance of the Permit.

4. Permit Fee. The Permit fee shall be as determined by the Commission from time to time and maintained by the Department of Public Works in its schedule of fees and charges. The fee shall increase five hundred (500%) percent in the event any work requiring a Permit is commenced prior to obtaining a Permit, without effect on penalties arising out of a prosecution for a violation of this Ordinance.

5. Permit Review, Inspection and Issuance. The Permit application shall be reviewed by the City Forester and based thereon, and following site inspection, the City Forester may reject the application for insufficient data, or as being untimely, grant or deny the Permit, or grant the Permit with conditions and/or limitations.

The Permit may authorize the removal of protected trees where the landscape plan provides for tree removal, replacement and additional tree planting with the result that there will be an overall improvement in the environmental condition and aesthetic character of the site, or where the tree(s):

a. Pose a safety hazard to pedestrian or vehicular traffic or threaten to cause disruption to public utility services;

b. Pose a safety hazard to buildings or structures;

c. Prevent access to a lot or parcel of land;

d. Unreasonably prevents development of a lot or parcel of land or the physical use thereof, provided the applicant has not failed to design and locate the proposed improvements to minimize the removal of trees;

e. If diseased or weakened by age, storm, fire or other cause, so as to pose a danger to persons, property, improvements or other trees;

6. Permit Conditions. Any Permit issued for a site containing a protected tree shall include the following conditions:

a. Prior to and during the construction or land disturbance, the owner, developer or agent thereof shall clearly mark (with red flagging) all trees proposed to be removed and shall erect barricades around all trees to be protected. The barricades shall remain in place and in good condition throughout the construction and land disturbance activity. Removal of other vegetation within any tree protection zone identified on the Permit, shall be accomplished by mowing or hand clearing only. If improvements are to be located within the tree protection zone, clearing by machinery will be allowed, but only in the area and to the extent necessary to install the improvements.

b. Unless otherwise approved by the City Forester, required tree protective barricades shall be installed no closer than ten (10') feet from the trunk or at the outer edge of the dripline, whichever is greater, to shield all trees or groups of trees to be protected. The barricades shall be constructed in a post

and rail configuration. The upright posts shall be a minimum of a two (2") inch by two (2") inch wooden stake, six (6') feet in length. Connecting the upright posts shall be a minimum of a single one (1") inch by four (4") inch rail. The maximum distance allowed between upright posts is eight (8') feet. "Do Not Enter" signs shall be posted on all barricades.

c. Large property areas containing protected trees and separated from construction or land clearing areas, road rights-of-ways, lakes and utility easements may be barricaded off, in lieu of erecting barriers, as required by §§a. and b., by placing stakes a maximum of twenty-five (25') feet apart and connecting the stakes with two (2) lines of red colored ribbon from stake to stake and posting "Do Not Enter" signs along the outside perimeters of such areas at regular intervals.

d. Silt barriers, hay bales or similarly effective erosion control barriers shall be required in any area where erosion or siltation may cause damage to protected trees.

e. There shall be no movement, cleaning or storage of equipment within a designated tree protection zone. The owner, developer or agent shall not permit the placement of construction material, debris, or fill; nor cause or permit disposal of waste materials such as paints, oils, solvents, asphalt, concrete, mortar or any other harmful material within the dripline of any protected tree.

f. Where elevation changes are proposed within a designated tree protection zone, the applicant shall be required to design and submit drawings of appropriate root protection devices; i.e., drain tiles, retaining walls, etc., for approval. These root protection devices shall be in place prior to the deposit of fill, or excavation of soil from the protected zone.

g. No damaging attachment, wires, signs or permits may be fastened to any tree protected by this Ordinance.

h. Pruning trees for construction clearance shall be minimal to provide for passage of equipment and personnel, as well as to accommodate buildings and structures. Oaks and elms shall not be pruned from May through the end of August during the Permit term.

i. Trenching is prohibited for any reason, including utility installation within the dripline of protected trees during construction or thereafter. Tunnelling to a minimum depth of thirty (30") inches below existing tree grade within the dripline is permitted.

7. Tree Replacement And Planting Standards. As a condition of the granting of permission to remove a tree, the applicant shall be required to relocate the tree(s) being removed or replace the tree(s). The replacement(s) shall have at least equal shade potential and other approved characteristics comparable to those of the tree removed. Replacement shall be diameter inch for diameter inch removed, i.e., eighteen (18") inch diameter = six (6) trees @ three (3") inches diameter. Alternatives, with respect to size, number and species may be considered but must have written approval of the City Forester before implementation.

A minimum of one (1) replacement tree shall be required for each two thousand (2,000) square feet of lot or parcel of land not improved by a building or structure for which a Tree Permit has been issued. Any tree(s) left in good growing condition on the site shall be counted toward the minimum requirement. Replacement trees shall have a single stem, with a single terminal leader, specimen grade and conform to the American Standard for Nursery Stock Standards, published by the American Association of Nurserymen, Inc.. All replacement trees shall be a minimum of eight (8') feet in height, when planted, and have a diameter of at least two (2") inches, measured six (6") inches above grade. Trees shall be planted in accordance with the most recent Edition of the International Society of Arboriculture Standards.

Where a tree(s) is(are) to be removed under the provision of this Ordinance, the City Forester shall have the option, with owner's permission, to relocate the tree(s) not being relocated within property to another property, at the City's expense. The relocation shall be accomplished within fifteen (15) working days of the issuance of a Permit or other suitable schedule as agreed to by the City Forester and applicant.

Trees planted in compliance with an approved landscape plan required under another Ordinance may

be used to help satisfy the requirements of this Section. However, there may be different requirements in regard to species, sizes, and locations. It is the applicants responsibility to consult with the City Forester to resolve any potential conflicts, prior to the installation of replacement trees.

Trees required to be planted in accordance with this Section shall be in place and established prior to the issuance of a Certificate of Occupancy. No tree shall be located closer than five (5') feet to any property line or underground utility line. Replacement trees shall not be planted underneath or near overhead utility lines, unless they are a species which will attain a height that would not interfere with such lines. The planting site must have sufficient root zone and canopy space to reasonably allow the tree(s) to grow to a mature size.

Replacement tree(s) shall be planted either bareroot or balled and burlapped. A minimum of one (1) stake, set below the bottom of the planting pit, shall be used for bareroot trees. Only a webbing material with a width greater than one (1") inch may be used to hold the tree(s) attached to the stake by itself or with wire. Planting pits shall be as deep or slightly less than the depth of the root ball, so that the root collar remains at grade or slightly higher. Planting pits may be as wide as possible within the upper eighteen (18") inches of the surface. All trees shall receive mulch, composed of approved materials, at a minimum depth of three (3") inches and a minimum width of three (3') feet from the stem for trees two (2") in diameter, six (6") inches above grade, and one (1') foot wider for each additional tree-inch diameter increase, i.e., three (3") tree = mulch four (4') feet wide from the stem, or as approved by the City Forester.

8. Periodic Inspections. The City Forester shall conduct periodic inspections of the site during land disturbance and construction, in order to ensure compliance with this Ordinance.

9. Tree Survival. The property owner shall be responsible for the maintenance and survival of trees protected on site and planted pursuant to this Ordinance. All trees relocated or replaced in accordance with the terms of this Ordinance shall be replaced should the trees expire anytime within two (2) years after City approval of site planting.

34.11 ENFORCEMENT

This Chapter shall be enforced by the City Forester and designees thereof.

Any City Department which observes a violation of this Chapter shall bring said violations to the attention of the City Forester.

34.12 ADMINISTRATIVE REMEDIES

Until the provisions of this Chapter, including the conditions on any Permits issued thereunder, have been fully met, the City shall withhold issuance of any Land Use Permit, Building Permit, Certificate of Occupancy or inspection required under the current City Building Code or issue stop orders for any land development involving tree removal.

34.13 APPEALS

Any person aggrieved by the administration or interpretation of any of the terms or provisions of this Chapter, who is not in violation of this Ordinance, may appeal to the Commission within fifteen (15) days of receiving notice of such administration or interpretation, which, after a hearing, with notice to the appellant, may reverse, affirm or modify, in whole or in part, the order, requirement, decision or determination of the City Forester, and to that end shall have all the powers of the City Forester. The notice of appeal shall be filed with the Department of Public Works.

34.135 SPECIAL CHARGES

The City may specially charge any property for work performed by or at the direction of the City, where any work is done on such property or in the lawn park area abutting such property to secure compliance with this Ordinance, under circumstances where the property owner has been notified of the work to be performed and has failed to timely perform the work. The special charge shall include a Seventy-five (\$75.00) Dollar administrative fee.

34.14 PENALTY

Any person who by himself/herself or by his/her agent or employee, shall violate any of the provisions of this Chapter, shall, upon conviction, pay a forfeiture of not less than Twenty-five (\$25.00) Dollars and not more than One Thousand (\$1,000.00) Dollars, and in default of payment thereof, be imprisoned in the County Jail for a period not to exceed ninety (90) days. A separate offense shall be deemed to have been committed on every day on which a violation occurs or continues.

CHAPTER XXXV
IMPACT FEES

35.01 PURPOSE

The purpose of this Chapter is to impose Impact Fees in accordance with Section 66.0617, Wisconsin Statutes, as a condition of an approval granted for the development of land, to be expended as capital costs by the City in the provision of public facilities required to meet the demands for public services by the new development. The requirements of this Chapter are in addition to the requirements of Chapter 17, entitled "Regulating the Division and Platting of Land", and other applicable ordinances.

35.02 DEFINITIONS

In this Chapter:

A. "Capital Costs" means the capital costs to construct, expand or improve public facilities, including the cost of land, and including legal, engineering and design costs to construct, expand or improve public facilities, except that not more than ten (10%) percent of capital costs may consist of legal, engineering and design costs unless the City demonstrates that its legal, engineering and design costs which relate directly to the public improvement for which the Impact Fees were imposed exceed ten (10%) percent of capital costs. "Capital costs" does not include other noncapital costs to construct, expand or improve public facilities, vehicles or the costs of equipment to construct, expand or improve public facilities.

B. "City" shall mean the City of Kenosha, Wisconsin.

C. "Developer" means a person, party, firm, corporation or other legal entity that constructs or creates a land development.

D. "Development" means the real property which is the subject of land development.

E. "Impact Fees" means cash contributions, contributions of land or interests in land or any other items of value that are imposed on a developer by the City under this Chapter.

F. "Land Development" means the construction or modification of improvements to real property that creates additional residential dwelling units within the City or that results in nonresidential uses that create a need for new, expanded or improved public facilities within the City.

G. "Public Facilities" means highways, as defined in Section 340.01(22), Wisconsin Statutes, and other transportation facilities, traffic control devices, facilities for collecting and treating sewage, facilities for collecting and treating storm and surface waters, facilities for pumping, storing and distributing water, parks, playgrounds, land for athletic fields, solid waste and recycling facilities, fire protection facilities, law enforcement facilities, emergency medical facilities and libraries. "Public facilities" does not include facilities owned by a school district. With regard to Impact Fees that were first imposed before June 14, 2006, "Public Facilities" includes other recreational facilities that were substantially completed by June 14, 2006.

H. "Service Area" means a geographic area delineated by the City within which there are public facilities relative to a certain number of persons, parcels of land or other appropriate measure, as specified by the City.

35.03 PUBLIC FACILITIES NEED ASSESSMENT

This Chapter is based upon a Public Facilities Need Assessment which is on file in the office of the City Clerk and available for inspection and/or copying in accordance with the State Public Records and Property Law, Subchapter II of Chapter 19, Wisconsin Statutes.

35.03 The Public Facilities Need Assessment includes:

A. An inventory of existing Public Facilities, including an identification of any existing deficiencies in the quantity or quality of those Public Facilities for which an Impact Fee is imposed.

B. An identification of the new Public Facilities, or improvements or expansions of existing Public Facilities, that will be required because of Land Development for which an Impact Fee is imposed. This identification is based on explicitly identified Service Areas and service standards.

C. A detailed estimate of the Capital Costs of providing the new Public Facilities or the improvements or expansions in existing Public Facilities, including an estimate of the effect of recovering these Capital Costs through Impact Fees on the availability of affordable housing within the City.

35.04 FINDING OF REASONABLENESS AND STATUTORY COMPLIANCE

Impact Fees imposed by this Chapter are found by the Common Council of City to be reasonable and in compliance with Section 66.0617, Wisconsin Statutes in that they:

A. Bear a rational relationship to the need for new, expanded or improved Public Facilities that are required to serve Land Development.

B. Do not exceed the proportionate share of the Capital Costs that are required to serve Land Development, as compared to existing uses of land within City.

C. Are based upon actual Capital Costs or reasonable estimates of Capital Costs for new, expanded or improved Public Facilities.

D. Do not include amounts necessary to address existing deficiencies in Public Facilities.

E. Do not prohibit or deter the construction of affordable housing within the City.

35.05 IMPACT FEE REDUCTION

A. Impact Fees imposed by this Chapter shall be reduced to the extent necessary:

1. To compensate for other Capital Costs imposed by City with respect to Land Development to provide or pay for Public Facilities, including special assessments, special charges, land dedications or fees in lieu of land dedications under Chapter 236, Wisconsin Statutes, or any other items of value.

2. To compensate for moneys received from the Federal or State government specifically to provide or pay for the Public Facilities for which the Impact Fees are imposed.

B. The Board of Park Commissioners may, in its discretion, provide for an exemption from, or a reduction in the amount of Park/Open Space Impact Fees imposed on a Developer that provides low-cost housing in accordance with guidelines established by the Department of City Development, except that no amount of an Impact Fee for which an exemption or reduction is provided under this Section may be shifted to any other development in the Land Development in which the low-cost housing is located or to any other Land Development in the City.

35.07 PAYMENT OF IMPACT FEES

A Developer shall pay an Impact Fee for any Land Development, in full, to the City Clerk/Treasurer, upon the issuance of a Building Permit.

35.08 IMPACT FEE REVENUES

Revenues from Impact Fees shall be placed in a segregated, interest bearing account, and shall be accounted for separately from the other funds of City. Impact Fee revenues and interest earned on Impact Fee revenues may be expended only for Capital Costs for which the Impact Fees were imposed.

The revenue and expenditure totals for each Impact Fee must be included in the City's annual budget, and a summary of the revenue and expenditure totals for each Impact Fee must also be made available in the City's annual budget summary as required under Section 65.90(3)(a), Wisconsin Statutes.

35.09 TIME FOR USE OF IMPACT FEES

Impact Fees imposed and collected by City under this Chapter shall be used within the time limits defined by Section 66.0617(9), Wisconsin Statutes, by City to pay the Capital Costs of the Public Facilities for which they were imposed, or in the alternative, refunded to the current owner of the real property with respect to which the Impact Fees were imposed, along with any interest that has accumulated. Specifically, the time limits shall be as follows:

A. With regard to Park/Open Space Impact Fees collected before January 1, 2003, not later than December 31, 2012.

B. With regard to Park/Open Space Impact Fees collected after December 31, 2002, and before April 11, 2006, not later than the first day of the 120th month beginning after the date on which the fee was collected.

C. With regard to Park/Open Space Impact Fees collected after April 10, 2006, but within seven (7) years of the effective date of the Ordinance enacting the Park/Open Space Impact Fees, ten (10) years after the effective date of the Ordinance enacting Park/Open Space Impact Fees.

D. With regard to Park/Open Space Impact Fees collected after April 10, 2006, but more than seven (7) years after the effective date of the Ordinance enacting Park/Open Space Impact Fees, fifteen (15) years after the date on which the fee was collected. Said fifteen (15) year period of time is found to be reasonable by the Common Council of the City in view of the appropriate planning and financing periods for the particular types of facilities for which said Impact Fees are imposed.

E. With regard to Sewer Impact Fees collected within seven (7) years after the effective date of the Ordinance enacting Sewer Impact Fees, ten (10) years after the effective date of the Ordinance enacting Sewer Impact Fees.

F. With regard to Sewer Impact Fees collected more than seven (7) years after the effective date of the Ordinance enacting Sewer Impact Fees, twenty (20) years after the date on which the fee was collected. Said twenty (20) year period of time is found to be reasonable by the Common Council of the City in view of the appropriate planning and financing periods for the particular types of facilities for which said Impact Fees are imposed.

35.10 IMPACT FEES

In addition to a Storm and Surface Water Impact Fee, Impact Fees are imposed upon Developers of land, as follows:

A Park/Open Space Impact Fee to acquire real property for parks or open space and for the development and improvement of such real property. The real property acquired, developed or improved may be in the nature of a neighborhood park/open space directly serving the development, or in the nature

CODE OF GENERAL ORDINANCES, 2021 - KENOSHA, WISCONSIN

of a park/open space which benefit Development and entire City, such as, but not limited to, golf courses, swimming pools, fishing facilities, athletic fields and environmental corridors. The costs of equipment not physically attached to real property, and the costs of operation are ineligible costs.

The fee shall be as follows:

For one (1) and two (2) family development, five (5%) percent of the value of the land, subject to development, excluding land dedicated as a public street, or for any other public purpose, but not less than One Thousand Four Hundred Fifteen (\$1,415.00) Dollars per lot. Land value shall, at the option of the Department of City Development, be the assessed value or the value determined by an appraiser retained by the Department.

For multifamily development (residential development of more than two (2) units per building), five (5%) percent of the value of the land, subject to development, excluding land dedicated as a public street, or for any other public purpose, but not less than One Thousand Two Hundred Five (\$1,205.00) Dollars per dwelling unit. Land value shall, at the option of the Department of City Development, be the assessed value or the value determined by an appraiser retained by the Department.

B. Sewer Impact Fee. To promote the public health, safety and general welfare of the community, and to facilitate the adequate provision of sanitary sewerage facilities, Impact Fees are imposed upon developers to pay for the capital costs that are necessary to accommodate land development.

The fee shall be as follows:

Water Meter Size	Equivalency Factor	Recommended Fee
5/8"	1	\$3,281
3/4"	1	\$3,281
1"	2.5	\$8,204
1-1/2"	5	\$16,407
2"	8	\$26,252
3"	15	\$49,222
4"	25	\$82,037
6"	50	\$164,074
8"	80	\$262,518
10"	120	\$393,777

C. The Impact Fees imposed under this Section shall be increased annually at a rate equal to the percentage change in the Engineering News Record Construction Cost Index for the Chicago Region for the previous twelve (12) months, with the adjustment effective January 1 of each year. The City Clerk/Treasurer, or designee, shall calculate the adjusted fees and maintain a copy of the calculation and the adjusted Impact Fees in the office of the City Clerk/Treasurer.

35.11 APPEAL

A. A Developer upon whom a Park/Open Space Impact Fee is imposed shall have the right to contest the amount, collection or use of said Impact Fee by filing a written Notice of Appeal with the City Clerk/Treasurer within thirty (30) days following the imposition of the Park/Open Space Impact Fee. Upon the filing of a timely appeal, the appeal shall be reviewed by the City Finance Committee, who shall provide the Developer with notice and an opportunity to be heard and then make a recommendation to the Common Council of City. The Common Council of City shall make a determination on timely appeals within ninety (90) days of the date of the filing of the Notice of Appeal. The Common Council of City may affirm, negate, or modify the Park/Open Space Impact Fee.

CODE OF GENERAL ORDINANCES, 2021 - KENOSHA, WISCONSIN

B. A Developer upon whom a Sewer Impact Fee is imposed shall have the right to contest the amount, collection or use of said Impact Fee by filing a written Notice of Appeal with the General Manager of the Kenosha Water Utility within thirty (30) days of the imposition of the Sewer Impact Fee. Upon the filing of a timely appeal, the Board of Water Commissioners shall provide the Developer with notice of an opportunity to be heard. The Board of Water Commissioners shall make a determination on timely appeals within ninety (90) days of the date of the filing of the Notice of Appeal. The Board of Water Commissioners may affirm, negate, or modify the Sewer Impact Fee.

CHAPTER XXXVI
POST-CONSTRUCTION
STORMWATER MANAGEMENT ORDINANCE

36.01 AUTHORITY

A. Statutory Authority. This Ordinance is adopted by the Common Council of the City of Kenosha, Wisconsin, pursuant to Section 62.234 of the Wisconsin Statutes. Except as otherwise specified in Section 62.234, Wisconsin Statutes, Section 62.23 of the Wisconsin Statutes, applies to this Chapter and to any amendments to this Ordinance.

B. Nonlimitation. The provisions of this Chapter are deemed not to limit any other lawful regulatory powers of the City of Kenosha.

C. More Stringent Standards. The requirements of this Chapter do not preempt more stringent stormwater management requirements that may be imposed by any of the following:

1. Wisconsin Department of Natural Resources administrative rules, permits or approvals, including those authorized under Sections 281.16 and 283.33 of the Wisconsin Statutes.
2. Targeted non-agricultural performance standards promulgated in rules by the Wisconsin Department of Natural Resources under Section NR 151.004, Wisconsin Administrative Code.

D. Responsibility For Enforcement. The Common Council hereby designates the Director of Public Works, or his/her designee, shall administer and enforce the provisions of this Chapter.

36.02 FINDINGS AND PURPOSE

A. Findings. The Common Council finds that uncontrolled, post-construction runoff has a significant impact upon water resources and the health, safety and general welfare of the community, and diminishes the public enjoyment and use of natural resources. Specifically, uncontrolled post-construction runoff can:

1. Degrade physical stream habitat by increasing stream bank erosion, increasing streambed scour, diminishing groundwater recharge, diminishing stream base flows and increasing stream temperature.
2. Diminish the capacity of lakes and streams to support fish, aquatic life, recreation and water supply uses by increasing pollutant loading of sediment, suspended solids, nutrients, heavy metals, bacteria, pathogens and other urban pollutants.
3. Alter wetland communities by changing wetland hydrology and by increasing pollutant loads.
4. Reduce the quality of groundwater by increasing pollutant loading.
5. Threaten public health, safety, property and general welfare by overtaxing storm sewers, drainageways and other minor drainage facilities.
6. Threaten public health, safety, property and general welfare by increasing major flood peaks and volumes.
7. Undermine floodplain management efforts by increasing the incidence and levels of flooding.

B. Purpose. It is the purpose of this Chapter to establish long term, post-construction runoff management requirements that will diminish the threats to public health, safety, welfare and aquatic environment. Specific purposes are to:

1. Further the maintenance of safe and healthful conditions.
2. Prevent and control the adverse effects of stormwater; prevent and control soil erosion; prevent and control water pollution; protect spawning grounds, fish and aquatic life; control building sites,

placement of structures and land uses; preserve ground cover and scenic beauty; and promote sound economic growth.

3. Control exceedance of the safe capacity of existing drainage facilities and receiving water bodies; prevent undue channel erosion; control increases in the scouring and transportation of particulate matter; and prevent conditions that endanger downstream property.

36.03 INTENT

It is the intent of the Common Council that this Chapter will reduce post-construction stormwater discharges and associated pollutants reaching waters of the State. This Chapter may be applied on a site-by-site basis. The Common Council recognizes, however, that the preferred method of achieving the stormwater performance standards set forth in this Chapter is through the preparation and implementation of comprehensive, systems-level stormwater management plans that cover hydrologic units, such as watersheds, on a municipal and regional scale. Such plans may prescribe regional stormwater devices, practices or systems, any of which may be designed to treat runoff from more than one site prior to discharge to waters of the State. Where such plans are in conformance with the performance standards developed under Section 281.16 of the Wisconsin Statutes, for regional stormwater management measures and have been approved by the Common Council, it is the intent of this Chapter that the approved plan be used to identify post-construction management measures acceptable for the community.

36.04 APPLICABILITY OF CODE

A. Application. This Chapter applies after final stabilization to a site of land-disturbing construction activity on a post-construction site that was subject to one (1) or more acres of land-disturbing construction activity. This Chapter also applies to post-construction sites of any size that, in the opinion of the Director of Public Works, or designee, are likely to result in runoff that exceeds the safe capacity of the existing drainage facilities or receiving body of water, that causes undue channel erosion, that increases water pollution by scouring or the transportation of particulate matter, or that endangers property or public safety.

B. Exemption. Subsection 36.04 A. notwithstanding, a site that meets any of the following criteria is exempt from the requirements of this Chapter:

1. Nonpoint discharges from agricultural facilities and practices.
2. Nonpoint discharges from silviculture activities.
3. Routine maintenance for project sites under five (5) acres of land disturbance if performed to maintain the original line and grade, hydraulic capacity or original purpose of the facility.
4. Underground utility construction, such as water, sewer and fiber optic lines. This exemption does not apply to the construction of any aboveground structures associated with utility construction.
5. Activities conducted by a State agency, as defined under Section 277.02(1) of the Wisconsin Statutes, but also including the office of District Attorney, which is subject to the State plan promulgated or a memorandum of understanding entered into under Section 281.33 of the Wisconsin Statutes.

C. Extraterritorial Jurisdiction. This Chapter applies to post-construction sites within the boundaries and jurisdiction of the City, as well as the extraterritorial division of land subject to an ordinance enacted pursuant to Sections 236.45(2) and (3) of the Wisconsin Statutes.

36.05 DEFINITIONS

Administering Authority means the City's Director of Public Works, or his/her designee.

Agricultural Facility means a structure associated with an agricultural practice, per the meaning

given in Section 281.16 of the Wisconsin Statutes, or as amended.

Agricultural Practice means beekeeping; commercial feedlots; dairying; egg production; floricultural; fish or fur farming; grazing; livestock raising; maintaining orchards; poultry raising; raising of grain, grass, mint and seed crops; raising of fruits, nuts and berries; sod farming; placing land in Federal programs in return for payments in kind; owning land, at least thirty-five (35) acres of which is enrolled in the Conservation Reserve Program under 16 USC 3831 to 3836; and, vegetable raising, per the meaning given in Section 281.16 of the Wisconsin Statutes, but vegetable raising is included in the definition of agricultural practice only if the pervious areas in which the vegetable raising activity is occurring is separated from pervious surfaces contiguous to the public right-of-way by a buffer area of grass which maintains separation of no less than ten (10') feet between the pervious area where the vegetable raising activity is occurring and the impervious area.

As-Built means a record or plan illustrating how a project was built in fact and not necessarily how it was planned.

Average Annual Rainfall means a calendar year of precipitation, excluding snow, which is considered typical.

Best Management Practice (BMP) means structural or non-structural measures, practices, techniques or devices employed to avoid or minimize soil, sediment or pollutants carried in runoff to waters of the State.

Business Day means a day the office of the City's Director of Public Works is routinely and customarily open for business.

Cease and Desist Order means a court-issued order to halt land-disturbing construction activity that is being conducted without the required permit.

Combined Sewer System means a system for conveying both sanitary sewage and storm water runoff.

Connected Imperviousness means an impervious surface that is directly connected to a separate storm sewer or water of the State via an impervious flowpath.

Design Storm means a hypothetical discrete rainstorm characterized by a specific duration, temporal distribution, rainfall intensity, return frequency, and total depth of rainfall.

Development means residential, commercial, industrial or institutional land uses and associated roads.

Division of Land means the creation from one parcel of five (5) or more parcels or buildings sites of five (5) or fewer acres each in area where such creation occurs at one time or through the successive partition within a five (5) year period.

Effective Infiltration Area means the area of the infiltration system that is used to infiltrate runoff and does not include the area used for site access, berms or pretreatment.

Erosion means the process by which the land's surface is worn away by the action of wind, water, ice or gravity.

Exceptional Resource Waters means waters listed in Section NR 102.11, Wisconsin Administrative Code.

Extraterritorial means the unincorporated area with three (3) miles of the corporate limits of the City of Kenosha.

Final Stabilization means that all land-disturbing construction activities at the construction site have been completed and that a uniform perennial vegetative cover has been established, with a density of at least seventy (70%) percent of the cover, for the unpaved areas and areas not covered by permanent structures, or that employ equivalent permanent stabilization measures.

Financial Guarantee means a Performance Bond, Maintenance Bond, Surety Bond, Irrevocable Letter of Credit, or similar guarantees submitted to the Director of Public Works, or his/her designee, by the responsible party to assure that the requirements of this Chapter are carried out in compliance with the Stormwater Management Plan.

Governing Body means the Common Council of the City of Kenosha, Wisconsin.

Impervious Surface means an area that releases as runoff all or a large portion of the precipitation

that falls on it, except for frozen soil. Rooftops, sidewalks, driveways, parking lots and streets, including those comprised of compacted stone or gravel, are examples of areas that typically are impervious surfaces.

In-Fill Area means an undeveloped area of land located within existing development.

Infiltration means the entry of precipitation or runoff into or through the soil.

Infiltration System means a device or practice, such as a basin, trench, rain garden or swale designed specifically to encourage infiltration, but does not include natural infiltration in pervious surfaces such as lawns, redirecting of rooftop downspouts onto lawns or minimal infiltration from practices, such as swales or roadside channels designed for conveyance and pollutant removal only.

Karst Feature means an area or surficial geologic feature subject to bedrock dissolution so that it is likely to provide a conduit to groundwater, and may include caves, enlarged fractures, mine features, exposed bedrock surfaces, sinkholes, springs, seeps or swallets.

Land-Disturbing Construction Activity means any manmade alteration of the land surface resulting in a change in the topography or existing vegetative or non-vegetative soil cover, that may result in runoff and lead to an increase in soil erosion and movement of sediment into waters of the State. Land-Disturbing Construction Activity includes clearing and grubbing, demolition, excavating, pit trench dewatering, filling and grading activities.

Maintenance Agreement means an agreement that provides for long term maintenance of stormwater management practices.

MEP or Maximum Extent Practicable means a level of implementing Best Management Practices in order to achieve a performance standard specified in this Chapter which takes into account the best available technology, cost effectiveness and other competing issues, such as human safety and welfare, endangered and threatened resources, historic properties and geographic features. MEP allows flexibility in the way to meet the performance standards and may vary based on the performance standard and site conditions.

Navigable, when applied to a waterway, means is capable of floating any boat, skiff, canoe, or kayak, of the shallowest draft used for recreational purposes in a waterway, that if not occurring continuously, at least occurs seasonably of a sufficient length of time to make the waterway useful as a highway.

New Development means development resulting from the conversion of previously undeveloped land or agricultural land uses.

Non-Navigable, when applied to a waterway, means not navigable.

Off-Site means located outside the property boundary described in the permit application.

On-Site means located within the property boundary described in the permit application.

Ordinary High Water Mark means the point on the bank or shore up to which the presence and action of surface water is so continuous as to leave a distinctive mark, such as by erosion, destruction or prevention of terrestrial vegetation, predominance of aquatic vegetation, or other easily recognized characteristics. Where the bank or shore at any particular place is of such character that it is difficult or impossible to ascertain where the point of the ordinary high water mark is, recourse may be had to the opposite bank of a stream or to other places on the shore of a lake or flowage to determine whether a given stage of water is above or below the ordinary high water mark in Section NR 115.03(6), Wisconsin Administrative Code, per the meaning in Section NR 115.03, Wisconsin Administrative Code, or as amended.

Outstanding Resource Waters means waters listed in Section NR 102.10, Wisconsin Administrative Code.

Percent Fines means the percentage of a given sample of soil, which passes through a #200 sieve.

Performance Standard means a narrative or measurable number specifying the minimum acceptable outcome for a facility or practice.

Permit means a written authorization made by the Director of Public Works, or designee, to the applicant to conduct land-disturbing construction activity or to discharge post-construction runoff to waters of the State.

Permit Administration Fee means a sum of money paid to the Director of Public Works or his/her

designee by the permit applicant for the purpose of recouping the expenses incurred by the authority in administering the permit.

Pervious Surface means an area that releases as runoff a small portion of the precipitation that falls on it. Lawns, gardens, parks, forests or other similar vegetated areas are examples of surfaces that typically are pervious surfaces.

Pollutant means any dredged spoil, solid waste, incinerator residue, sewage, garbage, refuse, oil, sewage sludge, munitions, chemical wastes, biological materials, radioactive substance, heat, wrecked or discarded equipment, rock, sand, cellar dirt and industrial, municipal and agricultural waste discharged into water, per the meaning given in Section 283.01 of the Wisconsin Statutes, or as amended.

Pollution includes contaminating or rendering unclean or impure the waters of the State, or making the same injurious to public health, harmful for commercial or recreational use, or deleterious to fish, bird, animal or plant life, per the meaning given in Section 281.01 of the Wisconsin Statutes, or as amended.

Post-Construction Site means a construction site following the completion of land-disturbing construction activity and final site stabilization.

Pre-Development Condition means the extent and distribution of land cover types present before the initiation of land-disturbing construction activity, assuming that all land uses prior to development activity are managed in an environmentally sound manner.

Preventive Action Limit means a numerical value expressing the concentration of a substance in groundwater which is adopted under Section 160.15 of the Wisconsin Statutes, and Sections NR 140.10, 140.12 or 140.20, Wisconsin Administrative Code, per the meaning given in Section NR 140.05, Wisconsin Administrative Code, or as amended.

Protective Area means an area of land that commences at the top of the ordinary high water mark of lakes, streams, or rivers, or at the delineated boundary of wetlands, and that is the greatest of the following widths, as measured horizontally from the top of the channel or delineated wetland boundary to the closest impervious surface.

1. For outstanding resource waters and exceptional resource waters, and for wetlands in areas of special natural resource interest as specified in Section NR 103.04, Wisconsin Administrative Code, seventy-five (75') feet.

2. For perennial and intermittent streams identified on a United States geological survey 7.5 minute series topographic map, or a County soil survey map, whichever is more current, fifty (50') feet.

3. For lakes, fifty (50') feet.

4. For highly susceptible wetlands, fifty (50') feet. Highly susceptible wetlands include the following types: fens, sedge meadows, bogs, low prairies, conifer swamps, shrub swamps, other forested wetlands, fresh wet meadows, shallow marshes, deep marshes and seasonally flooded basins. Wetland boundary delineations shall be made in accordance with Section NR 103.08(1m), Wisconsin Administrative Code. This Section does not apply to wetlands that have been completely filled in accordance with all applicable State and Federal regulations. The protective area for wetlands that have been partially filled in accordance with all applicable State and Federal regulations shall be measured from the wetland boundary delineation after fill has been placed.

5. For less susceptible wetlands, ten (10%) percent of the average wetland width, but no less than ten (10') feet, nor more than thirty (30') feet. Less susceptible wetlands include degraded wetlands dominated by invasive species, such as reed canary grass.

6. In Paragraphs 1, 4, and 5 of this definition, determinations of the extent of the protective area adjacent to wetlands shall be made on the basis of the sensitivity and runoff susceptibility of the wetland in accordance with the standards and criteria in Section NR 103.03, Wisconsin Administrative Code.

7. For concentrated flow channels with drainage areas greater than one hundred thirty (130) acres, ten (10') feet.

Redevelopment means areas where development is replacing older development.

Responsible Party means any entity holding fee title to the property or performing services to meet the performance standards of this Chapter through a contract or other agreement.

Runoff means storm water or precipitation, including rain, snow or ice melt or similar water that

moves on the land surface via sheet or channelized flow.

Separate Storm Sewer means a conveyance or system of conveyances, including roads with drainage systems, streets, catch basins, curbs, gutters, ditches, constructed channels or storm drains, which meet all of the following criteria:

1. Is designed or used for collecting water or conveying runoff.
2. Is not part of a combined sewer system.
3. Is not draining to a storm water treatment device or system.
4. Discharges directly or indirectly to waters of the State.

Site means the entire area included in the legal description of the land on which the land-disturbing construction activity is proposed in the permit application.

Stop Work Order means an order issued by the Director of Public Works, or his/her designee, which requires that all construction activity on the site be stopped.

Stormwater Management Facilities means facilities designed to properly manage stormwater runoff in accordance with the City's Stormwater Management Criteria, which criteria may be updated or amended from time to time.

Stormwater Management Plan means a comprehensive plan designed to reduce the discharge of pollutants from stormwater after the site has undergone final stabilization following completion of the construction activity.

Stormwater Management System Plan is a comprehensive plan designed to reduce the discharge of runoff and pollutants from hydrologic units on a regional or municipal scale.

Technical Standard means a document that specifies design, predicted performance and operation and maintenance specifications for a material, device or method.

Top of the Channel means an edge or point on the landscape, landward from the ordinary high water mark of a surface water of the State, where the slope of the land begins to be less than twelve (12%) percent continually for at least fifty (50') feet. If the slope of the land is twelve (12%) percent or less continually for the initial fifty (50') feet, landward from the ordinary high water mark, the top of the channel is the ordinary high water mark.

TR-55 means the United State Department of Agriculture, Natural Resources Conservation Service (previously Soil Conservation Service), Urban Hydrology for Small Watersheds, Second Edition, Technical Release 55, June 1986.

Type II Distribution means a rainfall-type curve as established in the United States Department of Agriculture, Soil Conservation Service, Technical Paper 149, published 1973. The Type II curve is applicable to all of Wisconsin and represents the most intense storm pattern.

Waters of the State includes those portions of Lake Michigan and Lake Superior within the boundaries of this State, and all lakes, bays, rivers, streams, springs, ponds, wells, impounding reservoirs, marshes, watercourses, drainage systems and other surface water or groundwater, natural or artificial, public or private, within this State or its jurisdiction, per the meaning given in Section 281.01 of the Wisconsin Statutes, or as amended.

36.06 TECHNICAL STANDARDS

A. The following methods shall be used in designing the water quality, peak flow shaving and infiltration components of stormwater practices needed to meet the water quality standards of this Chapter.

1. Technical standards identified, developed or disseminated by the Wisconsin Department of Natural Resources under Subchapter V of Chapter NR 151, Wisconsin Administrative Code.
2. Design guidance and technical standard identified in the City of Kenosha Stormwater Management Criteria as developed and revised by the Director of Public Works, or his/her designee, and on file in the office of the City Engineer.
3. In this Chapter, the following year and location have been selected as average annual rainfall: Milwaukee, 1969 (March 28 - December 6).

B. Where technical standards have not been identified or developed in Section 36.06 A., other technical standards may be used provided that the methods have been approved by the Director of Public Works or his/her designee.

C. The Director of Public Works, or his/her designee, shall approve final design criteria, standards and specifications for BMP requirements in the event of conflicts between technical sources in Section 36.06 A.

36.07 PERFORMANCE STANDARDS

A. Responsible Party. The Responsible Party shall implement a Post-Construction Stormwater Management Plan that incorporates the requirements of this Section.

B. Plan. A written Stormwater Management Plan in accordance with Section 36.09 shall be developed and implemented for each post-construction site.

C. Requirements. The plan required under Subsection 36.07 B. shall include the following:

1. Total Suspended Solids. BMPs shall be designed, installed and maintained to control total suspended solids carried in runoff from the post-construction site as follows:

a. New and Infill Development. For new and infill development, by design, reduce to the maximum extent practicable, the total suspended solids load by eighty (80%) percent, based on the average annual rainfall, as compared to no runoff management controls. No person shall be required to exceed an eighty (80%) percent total suspended solids reduction to meet the requirements of this subdivision.

b. Redevelopment. For redevelopment, by design, reduce to the maximum extent practicable, the total suspended solids load by forty (40%) percent, based on the average annual rainfall, as compared to no runoff management controls. No person shall be required to exceed a forty (40%) percent total suspended solids reduction to meet the requirements of this subsection.

c. Reduction of Total Suspended Solids Load. Notwithstanding Subsections a. and b., if the design cannot achieve the applicable total suspended solids reduction specified, the Stormwater Management Plan shall include a written and site-specific explanation why that level of reduction is not attained and the total suspended solids load shall be reduced to the maximum extent practicable.

2. Peak Discharge.

a. By design, BMPs shall be employed to maintain or reduce the peak runoff discharge rates as compared to pre-development conditions of the two (2) year, twenty-four (24) hour design storm applicable to the post-construction site. For pre-development conditions, the runoff curve numbers in Table 1 shall be used.

TABLE 1 MAXIMUM PRE-DEVELOPMENT RUNOFF CURVE NUMBERS				
Hydro-logic Soil Group	A	B	C	D
Runoff Curve Number	56	70	71	71

b. By design, BMP's shall be designed and employed to reduce the peak discharge rates of the post-construction conditions for any storm, in areas where there is inadequate storm sewer or drainageway capacity. The control of peak discharge shall be required for all areas draining to navigable streams or to storm sewer systems that do not have at least capacity for the five (5) year rational method storm. Any

site with inadequate capacity downstream shall have the peak discharge reduced to a proportional share of the available downstream capacity based on the ratio of the development's area to the total drainage area. The available downstream capacity shall be set by the capacity of storm sewer pipes when flowing full, the overflow level for ditches and the top of the upstream end of the pipe for any culverts. None of these criteria shall preempt more stringent release rates.

3. Infiltration. BMPs shall be designed, installed, and maintained to infiltrate runoff to the maximum extent practicable in accordance with the following, except as provided in Subparagraphs e. through h.

a. Residential Developments. For residential developments, one of the following shall be met:

(1) Infiltrate sufficient runoff volume so that the post-development infiltration volume shall be at least ninety (90%) percent of the pre-development infiltration volume, based on an average annual rainfall. However, when designing appropriate infiltration systems to meet this requirement, no more than one (1%) percent of the project site is required as an effective infiltration area.

(2) Infiltrate twenty-five (25%) percent of the post-development runoff from the 2 year, twenty-four (24) hour design storm with a Type II Distribution. Separate curve numbers for pervious and impervious surfaces shall be used to calculate runoff volumes and not composite curve numbers as defined in TR-55. When designing appropriate infiltration systems to meet this requirement, no more than one (1%) percent of the project site is required as an effective infiltration area.

b. Non-Residential Development. For nonresidential development, including commercial, industrial and institutional development, one of the following shall be met:

(1) Infiltrate sufficient runoff volume so that the post-development infiltration volume shall be at least sixty (60%) percent of the pre-development infiltration volume, based on an average annual rainfall. When designing appropriate infiltration systems to meet this requirement, no more than two (2%) percent of the project site is required as an effective infiltration area.

(2) Infiltrate ten (10%) percent of the runoff from the 2 year, twenty-four (24) hour design storm with a Type-II Distribution. Separate curve numbers for pervious and impervious surfaces shall be used to calculate runoff volumes, and not composite curve numbers as defined in TR-55. When designing appropriate infiltration systems to meet this requirement, no more than two (2%) percent of the project site is required as an effective infiltration area.

c. Pretreatment. Before infiltrating runoff, pretreatment shall be required for parking lot runoff and for runoff from new road construction in commercial, industrial and institutional areas that will enter an infiltration system. The pretreatment shall be designed to protect the infiltration system from clogging prior to scheduled maintenance and to protect groundwater quality in accordance with Subparagraph h. Pretreatment options may include, but are not limited to, oil/grease separation, sedimentation, biofiltration, filtration, swales or filter strips.

d. Exclusions. The runoff from the following areas are prohibited from meeting the requirements of this Section:

(1) Areas associated with Tier 1 Industrial Facilities identified in Section NR 216.21(2)(a), Wisconsin Administrative Code, including storage, loading, rooftop and parking.

(2) Storage and loading areas of Tier 2 Industrial Facilities identified in Section NR 216.21(2)(b), Wisconsin Administrative Code.

(3) Fueling and vehicle maintenance areas.

(4) Areas within one thousand (1,000') feet upgradient, or within one hundred (100') feet downgradient of Karst features.

(5) Areas with less than three (3') feet separation distance from the bottom of the infiltration system to the elevation of seasonal high groundwater or the top of bedrock, except this subsection does not prohibit infiltration of roof runoff.

(6) Areas with runoff from industrial, commercial and institutional parking lots and roads and residential arterial roads with less than five (5') feet separation distance from the bottom of the infiltration system to the elevation of seasonal high groundwater or the top of bedrock.

(7) Areas within four hundred (400') feet of a community water system well as specified in Section

NR 811.16(4), Wisconsin Administrative Code, or within one hundred (100') feet of a private well as specified in Section NR 812.08(4), Wisconsin Administrative Code, for runoff infiltrated from commercial, industrial and institutional land uses or regional devices for residential development.

(8) Areas where contaminants of concern, as defined in Section NR 720.03(2), Wisconsin Administrative Code, are present in the soil through which infiltration will occur.

(9) Any area where the soil does not exhibit one of the following soil characteristics between the bottom of the infiltration system and the seasonal high groundwater and top of bedrock: at least a three (3) foot soil layer with twenty (20%) percent fines or greater; or at least a five (5) foot soil layer with ten (10%) percent fines or greater. This does not apply where the soil medium within the infiltration system provides an equivalent level of protection. This Subsection does not prohibit infiltration of roof runoff.

e. **Exemptions.** The following are not required to meet the requirements of this Section:

(1) Areas where the infiltration rate of the soil is less than 0.6 inches/hour measured at the site.

(2) Parking areas and access roads less than five thousand (5,000) square feet for commercial and industrial development.

(3) Redevelopment post-construction sites.

(4) In-fill development areas less than five (5) acres.

(5) Infiltration areas during periods when the soil on the site is frozen.

(6) Roads in commercial, industrial and institutional land uses, and arterial residential roads.

f. **Alternate Uses.** Where alternate uses of runoff are employed, such as for toilet flushing, laundry or irrigation, such alternate use shall be given equal credit toward the infiltration volume required by this Section.

g. **Compliance with Preventive Action Limit.**

(1) Infiltration systems designed in accordance with this Section shall, to the extent technically and economically feasible, minimize the level of pollutants infiltrating to groundwater and shall maintain compliance with the preventive action limit at a point of standards application in accordance with Chapter NR 140, Wisconsin Administrative Code. If site-specific information indicates that compliance with a preventive action limit is not achievable, the infiltration BMP may not be installed or shall be modified to prevent infiltration to the maximum extent practicable.

(2) Notwithstanding Subsection (1) above, the discharge from BMPs shall remain below the enforcement standard at the point of standards application.

i. **Design of Infiltration BMPs.** Design of infiltration BMPs shall comply with the technical standards developed by the Wisconsin Department of Natural Resources under Subchapter V of Section NR 151, Wisconsin Administrative Code.

j. **Evaluation of Infiltration BMP' Performance.** The performance of infiltration BMPs shall be evaluated using the WinSLAMM, Version 9.2.5. computer model available from the Wisconsin Department of Natural Resources.

4. Protective Areas.

a. **Post-Construction Sites.** This Paragraph 36.07 C.4. applies to post-construction sites located within a protective area, except those areas exempted pursuant to Subparagraph c. "Protective Area" does not include any area of land adjacent to any stream enclosed within a pipe or culvert, such that runoff cannot enter the enclosure at this location.

b. **Requirements.** The following requirements shall be met:

(1) Impervious surfaces shall be kept out of the protective area to the maximum extent practicable. The Stormwater Management Plan shall contain a written site-specific explanation for any parts of the protective area that are disturbed during construction.

(2) Where land-disturbing construction activity occurs within a protective area, and where no impervious surface is present, adequate sod or self-sustaining vegetative cover of seventy (70%) percent or greater shall be established and maintained. The adequate sod or self-sustaining vegetative cover shall be sufficient to provide for bank stability, maintenance of fish habitat and filtering of pollutants from upslope overland flow areas under sheet flow conditions. Non-vegetative materials, such as rock riprap, may be employed on the bank as necessary to prevent erosion, such as on steep slopes or where high

velocity flows occur.

(3) Best management practices, such as filter strips, swales or wet detention basins, that are designed to control pollutants from non-point sources maybe located in the protective area.

c. **Nonapplicable Areas.** This Paragraph does not apply to:

(1) Structures that cross or access surface waters, such as boat landings, bridges and culverts.

(2) Structures constructed in accordance with Section 59.692(1v) of the Wisconsin Statutes.

(3) Post-construction sites from which runoff does not enter the surface water, except to the extent that vegetative groundcover is necessary to maintain bank stability.

5. **Fueling and Vehicle Maintenance Areas.** Fueling and vehicle maintenance areas shall, to the maximum extent practicable, have BMPs designed, installed and maintained to reduce petroleum within runoff, such that the runoff that enters waters of the State contains no visible petroleum sheen.

6. **Swale Treatment For Transportation Facilities.**

a. **Applicability.** Except as provided in Subparagraph b., transportation facilities that use swales for runoff conveyance and pollutant removal meet all of the requirements of this Section, if the swales are designed to the maximum extent practicable to do all of the following:

(1) Be Vegetated. Where appropriate, however, nonvegetative measures may be employed to prevent erosion or provide for runoff treatment, such as rock riprap stabilization or check dams.

(2) Carry runoff through a swale for two hundred (200') feet or more in length that is designed with a flow velocity no greater than 1.5 feet per second for the peak flow generated using either a two (2) year, twenty-four (24) hour design storm or a two (2) year storm with a duration equal to the time of concentration as appropriate. If a swale of two hundred (200') feet in length cannot be designed with a flow velocity of 1.5 feet per second or less, then the flow velocity shall be reduced to the maximum extent practicable.

b. **Exemptions.** The Director of Public Works, or his/her designee, may, consistent with water quality standards, require other provisions of this Section be met on a transportation facility with an average daily travel of vehicles greater than two thousand five hundred (2,500) and where the initial surface water of the State that the runoff directly enters is any of the following:

(1) An outstanding resource water.

(2) An exceptional resource water.

(3) Waters listed in Section 303(d) of the Federal Clean Water Act that are identified as impaired in whole or in part, due to non-point source impacts.

(4) Waters where targeted performance standards are developed under Section NR 151.004, Wisconsin Administrative Code, to meet water quality standards.

D. General Considerations For On-Site and Off-Site Storm Water Management Measures. The following considerations shall be observed in managing runoff:

1. **Natural Topography and Land Cover Features.** Natural topography and land cover features such as natural swales, natural depressions, native soil infiltrating capacity, and natural groundwater recharge areas shall be preserved and used, to the extent possible, to meet the requirements of this Section.

2. **Emergency Overland Flow.** Emergency overland flow for all Stormwater Management Facilities shall be provided to prevent exceeding the safe capacity of downstream drainage facilities and prevent endangerment of downstream property or public safety. Emergency overland flow must be in compliance with the Kenosha Stormwater Management Criteria.

E. Location and Regional Treatment Option.

1. **On-Site/Off-Site Locations.** The BMPs may be located on-site or off-site as part of a regional stormwater device, practice or system.

2. **Post-Construction Runoff.** Post-construction runoff within a non-navigable surface water that flows into a BMP, such as a wet detention pond, is not required to meet the performance standards of this

Chapter. Post-construction BMPs may be located in non-navigable surface waters.

3. New Development Post-Construction Runoff. Except as allowed under Subparagraph 4., post-construction runoff from new development shall meet the post-construction performance standards prior to entering navigable surface water.

4. Exceptions. Post-construction runoff from any development within navigable surface water that flows into a BMP is not required to meet the performance standards of this Chapter if:

a. The BMP was constructed prior to the effective date of this Chapter and the BMP either received a permit issued under Chapter 30 of the Wisconsin Statutes, or the BMP did not require a Chapter 30 of the Wisconsin Statutes, permit; and,

b. The BMP is designed to provide runoff treatment from future upland development.

5. Runoff From Existing Development, Redevelopment and In-Fill Areas. Runoff from existing development, redevelopment and in-fill areas shall meet the post-construction performance standards in accordance with this Section.

a. To the maximum extent practicable, BMPs shall be located to treat runoff prior to discharge to navigable surface waters.

b. Post-construction BMPs for such runoff may be located in navigable surface water if allowable under all other applicable Federal, State and local regulations, such as Section NR 10, Wisconsin Administrative Code and Chapter 30 of the Wisconsin Statutes.

6. Runoff From a BMP. The discharge of runoff from a BMP, such as a wet detention pond, or after a series of such BMPs is subject to this Chapter.

7. Off-Site Management Measure Approval. The Director of Public Works, or his/her designee, may approve off-site management measures provided that all of the following conditions are met:

a. The Director of Public Works, or his/her designee, has determined that the post-construction runoff is covered by a Stormwater Management System Plan that contains management requirements consistent with the purpose and intent of this Chapter.

b. The off-site facility meets all of the following conditions:

(1) The facility is in place.

(2) The facility is designed and adequately sized to provide a level of stormwater control equal to or greater than that which would be afforded by on-site practices meeting the performance standards of this Chapter.

(3) The facility has legally obligated entity responsible for its long term operation and maintenance.

8. Fee For Post-Construction Runoff. Where a regional treatment option exists such that the Director of Public Works, or his/her designee, exempts the applicant from all or part of the minimum on-site stormwater management requirements, the applicant shall be required to pay a fee in an amount determined in negotiation with the Director of Public Works, or his/her designee. In determining the fee for post-construction runoff, the Director of Public Works, or his/her designee, shall consider an equitable distribution of the cost for land, engineering design, construction, and maintenance of the regional treatment option.

F. Additional Requirements to Protect Sensitive Resources. The Director of Public Works, or his/her designee, may establish stormwater management requirements more stringent than those set forth in this Section if the Director of Public Works, or his/her designee, determines that an added level of protection is needed to protect sensitive resources.

36.08 PERMIT REQUIREMENTS; PROCEDURES AND FEES

A. Permit Required. No responsible party may undertake a land-disturbing construction activity without receiving a Post-Construction Runoff Permit from the Director of Public Works, or his/her designee, prior to commencing the proposed activity.

B. Permit Application and Fees. Unless specifically excluded by this Chapter, any responsible party desiring a permit shall submit to the Director of Public Works, or his/her designee, a permit application made on a form provided by the Director of Public Works, or his/her designee, for that purpose.

1. Accompanying Documents. Unless otherwise excepted by this Chapter, a permit application must be accompanied by a Stormwater Management Plan, a Maintenance Agreement and a nonrefundable permit administration fee.

2. Requirements. The Stormwater Management Plan shall be prepared to meet the requirements of Sections 36.07 and 36.09. The Maintenance Agreement shall be prepared to meet the requirements of Section 36.10; the financial guarantee shall meet the requirements of Section 36.11. Fees shall be those established from time to time by Resolution of the Common Council as set forth in Section 36.12.

C. Review and Approval of Permit Application. The Director of Public Works, or his/her designee, shall review any permit application that is submitted together with a Stormwater Management Plan, Maintenance Agreement and the required fee. The following approval procedure shall be used:

1. Within twenty (20) business days of the receipt of a complete permit application, including all items as required by Subsection B. above, the Director of Public Works, or his/her designee, shall inform the applicant whether the application, plan and maintenance agreement are approved or disapproved based on the requirements of this Chapter.

2. If the Stormwater Permit application, plan and maintenance agreement are approved, or if an agreed-upon payment of fees in lieu of stormwater management practices is made, the Director of Public Works, or his/her designee, shall issue the permit.

3. If the Stormwater Permit application, plan or maintenance agreement are disapproved, the Director of Public Works, or his/her designee, shall detail, in writing, the reasons for disapproval.

4. The Director of Public Works, or his/her designee, may request additional information from the applicant. If additional information is submitted, the Director of Public Works, or his/her designee, shall have twenty (20) business days from the date the additional information is received, to inform the applicant that the plan and maintenance agreement are either approved or disapproved.

5. Failure by the Director of Public Works, or his/her designee, to inform the permit applicant of a decision within twenty (20) business days of a required submittal shall be deemed to mean disapproval of the submittal and the applicant may not proceed.

D. Permit Requirements. All permits issued under this Chapter shall be subject to the following conditions, and holders of permits issued under this Chapter shall be deemed to have accepted these conditions. The Director of Public Works, or his/her designee, may suspend or revoke a permit for violation of a permit condition, following written notification of the responsible party. An action by the Director of Public Works, or his/her designee, to suspend or revoke this permit may be appealed in accordance with Section 36.14.

1. Compliance with this permit does not relieve the responsible party of the responsibility to comply with other applicable Federal, State and local laws and regulations.

2. The responsible party shall design and install all structural and nonstructural stormwater management measures in accordance with the approved Stormwater Management Plan and this permit.

3. The responsible party shall notify the Director of Public Works, or his/her designee, in writing, at least two (2) business days before commencing any work in conjunction with the Stormwater Management Plan, and within two (2) business days upon completion of the stormwater management practices. If required as a special condition under Subsection E., the responsible party shall make additional notification according to a schedule set forth by the Director of Public Works, or his/her designee, so that practice installations can be inspected during construction.

4. Stormwater Management Facilities required as part of this Ordinance shall be certified "as-built" by a licensed professional engineer. Completed Stormwater Management Facilities must pass a final inspection by the Director of Public Works, or his/her designee, to determine if they are in accordance with the approved Stormwater Management Plan and this Chapter. The Director of Public Works, or his/her designee, shall notify the responsible party, in writing, of any changes required in such practices to bring

them into compliance with the conditions of this permit.

5. The responsible party shall notify the Director of Public Works, or his/her designee, of any significant modifications it intends to make to an approved Stormwater Management Plan. The Director of Public Works, or his/her designee, may require that the proposed modifications be submitted for approval prior to incorporation into the Stormwater Management Plan and execution by the responsible party.

6. The responsible party shall maintain all stormwater management practices in accordance with the Stormwater Management Plan until the practices either become the responsibility of the City, or are transferred to subsequent private owners as specified in the approved Maintenance Agreement.

7. The responsible party authorizes the Director of Public Works, or his/her designee, to perform any work or operations necessary to bring stormwater management measures into conformance with the approved Stormwater Management Plan, and consents to a special assessment or charge against the property as authorized under Subchapter VII of Chapter 66 of the Wisconsin Statutes, or to charging such costs against the financial guarantee posted under Section 36.11.

8. If so directed by the Director of Public Works, or his/her designee, the responsible party shall repair, at his/her own expense, all damage to adjoining municipal facilities and drainageways caused by runoff, where such damage is caused by activities that are not in compliance with the approved Stormwater Management Plan.

9. The responsible party shall permit property access to the Director of Public Works, or his/her designee, for the purpose of inspecting the property for compliance with the approved Stormwater Management Plan and this permit.

10. Where site development or redevelopment involves changes in direction, increases in peak rate and/or total volume of runoff from a site, the Director of Public Works, or his/her designee, may require the responsible party to make appropriate legal arrangements with affected property owners concerning the prevention of endangerment to property or public safety.

11. The responsible party is subject to the enforcement actions and penalties detailed in Section 36.13, if the responsible party fails to comply with the terms of this permit.

E. Permit Conditions. Permits issued under this Section may include conditions established by the Director of Public Works, or his/her designee, in addition to the requirements needed to meet the performance standards in Section 36.07, or a financial guarantee as provided for in Section 36.11.

F. Permit Duration. Permits issued under this Section shall be valid from the date of issuance through the date the Director of Public Works, or his/her designee, notifies the responsible party that all stormwater management practices have passed the final inspection required under Subsection D.4.

36.09 STORMWATER MANAGEMENT PLAN

A. Plan Requirements. The Stormwater Management Plan required under Section 36.08 B. shall contain, at a minimum, the following information:

1. Name, address and telephone number for the following, or their designees: landowner; developer; project engineer for practice design and certification; person(s) responsible for installation of stormwater management practices; and, person(s) responsible for maintenance of stormwater management practices prior to the transfer, if any, of maintenance responsibility to another party.

2. A proper legal description of the property proposed to be developed, referenced to the U.S. Public Land Survey System or to block and lot numbers within a recorded land subdivision plat.

3. Pre-development site conditions, including:

a. One (1) or more site maps at a scale of not less than one (1") inch equals two hundred (200') feet. The site maps shall show the following: site location and legal description of the property; predominant soil types and hydrologic soil groups; existing cover type and condition; topographic contours of the site not to exceed five (5') feet; topography and drainage network, including enough of the contiguous properties to show runoff patterns onto, through, and from the site; watercourses that may affect or be affected by runoff

from the site; watercourses that may affect or be affected by runoff from the site; flow path and direction for all stormwater conveyance sections; watershed boundaries used in hydrology determinations to show compliance with performance standards; lakes, streams, wetlands, channels, ditches, and other watercourses on and immediately adjacent to the site; limits of the one hundred (100) year floodplain; location of wells and wellhead protection areas covering the project area and delineated pursuant to Section NR 811.16, Wisconsin Administrative Code.

b. Hydrology and pollutant loading computations as needed to show compliance with performance standards. All major assumptions used in developing input parameters shall be clearly stated. The geographic areas used in making the calculations shall be clearly cross-referenced to the required map(s).

4. Post-development site conditions, including:

a. Explanation of the provisions to preserve and use natural topography and land cover features to minimize changes in peak flow runoff rates and volumes to surface waters and wetlands.

b. Explanation of any restrictions on stormwater management measures in the development area imposed by wellhead protection plans and ordinances.

c. One (1) or more site maps at a scale of not less than one (1") inch equals two hundred (200') feet showing the following: post-construction pervious areas, including vegetative cover-type and condition; impervious surfaces, including all buildings, structures and pavement; post-construction topographic contours of the site at a scale not to exceed five (5') feet; post-construction drainage network, including enough of the contiguous properties to show runoff patterns onto, through and from the site; locations and dimensions of drainage easements; locations of maintenance easements specified in the Maintenance Agreement; flow path and direction for all stormwater conveyance sections; location and type of all stormwater management conveyance and treatment practices, including the on-site and off-site tributary drainage area; location and type of conveyance system that will carry runoff from the drainage and treatment practices to the nearest adequate outlet, such as a curbed street, storm drain or natural drainageway; watershed boundaries used in hydrology and pollutant loading calculations and any changes to lakes, streams, wetlands, channels, ditches and other watercourse on and immediately adjacent to the site.

d. Hydrology and pollutant loading computations as needed to show compliance with performance standards. The computations shall be made for each discharge point in the development, and the geographic areas used in making the calculations shall be clearly cross-referenced to the required map(s).

e. Results of investigations of soils and groundwater required for the placement and design of stormwater management measures. Detailed drawings, including cross-sections and profiles of all permanent stormwater conveyance and treatment practices.

5. A description and installation schedule for the stormwater management practices needed to meet the performance standards in Section 36.07.

6. A Maintenance Plan developed for the life of each stormwater management practice, including the required maintenance activities and maintenance activity schedule.

7. Cost estimates for the construction, operation and maintenance of each stormwater management practice.

8. Other information requested in writing by the Director of Public Works, or his/her designee, to determine compliance of the proposed stormwater management measures with the provisions of this Chapter.

9. All site investigations, plans, designs, computations, and drawings shall be certified by a professional engineer licensed in the State of Wisconsin to be prepared in accordance with accepted engineering practice and the requirements of this Chapter.

B. Alternate Requirements. The Director of Public Works, or his/her designee, may prescribe alternative submittal requirements for applicants seeking an exemption to on-site stormwater management performance standards under Subsection 36.07 E.

36.10 MAINTENANCE

A. Maintenance Agreement Required. The Maintenance Agreement required under Subsection 36.08 B. for stormwater management practices shall be an agreement between the City and the responsible party to provide for maintenance of stormwater practices beyond the duration period of this permit. The Maintenance Agreement shall be filed with the Kenosha County Register of Deeds as a property deed restriction so that it is binding upon all subsequent owners of the land served by the stormwater management practices.

B. Agreement Provisions. The Maintenance Agreement shall contain the following information and provisions, and be consistent with the Maintenance Plan required by Subsection 36.09:

1. Identification of the stormwater facilities and designation of the drainage area served by the facilities.
2. A schedule for regular maintenance of each aspect of the Stormwater Management System consistent with the Stormwater Management Plan required under Subsection 36.08 B.
3. Identification of the responsible party(ies), organization or government responsible for long-term maintenance of the stormwater management practices identified in the Stormwater Management Plan required under Subsection 36.08 B.
4. Requirement that the responsible party(ies), organization or government shall maintain stormwater management practices in accordance with the schedule included in Paragraph 2.
5. Authorization for the Director of Public Works, or his/her designee, to access the property to conduct inspections of stormwater management practices as necessary to ascertain that the practices are being maintained and operated in accordance with the agreement.
6. A requirement on the Director of Public Works, or his/her designee, to maintain public records of the results of the site inspections, to inform the responsible party responsible for the maintenance of the inspection results, and to specifically indicate any corrective actions required to bring the stormwater management practice into proper working condition.
7. Agreement that the party designated under Paragraph 3, as responsible for long-term maintenance of the stormwater management practices, shall be notified by the Director of Public Works, or his/her designee, of maintenance problems which require correction. The specified corrective actions shall be undertaken within a reasonable time frame as set by the Director of Public Works, or his/her designee.
8. Authorization of the Director of Public Works, or his/her designee, to perform the corrected actions identified in the inspection report if the responsible party designated under Subsection 3 does not make the required corrections in the specified time period. The Director of Public Works, or his/her designee, shall enter the amount due on the tax rolls and collect the money as a special charge against the property pursuant to Subchapter VII of Chapter 66 of the Wisconsin Statutes.

C. Maintenance of Stormwater Facilities. The responsible party shall maintain stormwater facilities in accordance with standards identified in the City of Kenosha Stormwater Management Facilities Maintenance Criteria as developed and revised by the Director of Public Works, or his/her designee, and on file in the City Engineer's Office.

36.11 FINANCIAL GUARANTEE

A. Establishment of the Guarantee. The Director of Public Works, or his/her designee, may require the submittal of a financial guarantee, the form and type of which shall be acceptable to the Director of Public Works, or his/her designee. The financial guarantee shall be in an amount determined by the Director of Public Works, or his/her designee, to be the estimated cost of construction and the estimated cost of maintenance of the stormwater management practices during the period which the designated party in the Maintenance Agreement has maintenance responsibilities. The financial guarantee shall give

the Director of Public Works, or his/her designee, the authorization to use the funds to complete the stormwater management practices if the responsible party defaults or does not properly implement the approved Stormwater Management Plan, upon written notice to the responsible party by the Director of Public Works, or his/her designee, that the requirements of this Chapter have not been met.

B. Conditions For Release. Conditions for the release of the financial guarantee are as follows:

1. Upon submission of ,as built plans" by a professional engineer licensed in the State of Wisconsin, the Director of Public Works, or his/her designee, shall release the portion of the financial guarantee established under this Section to assure completion of installation of practice; the City shall retain therefrom, nevertheless, any costs incurred by the City to complete installation of practices. The Director of Public Works, or his/her designee, may allow for a partial pro rata release of the financial guarantee based on the completion of various development stages.

2. At such time that the responsibility for practice maintenance is passed on to another entity via an approved Maintenance Agreement, and the other entity has posted suitable financial guarantees, the Director of Public Works, or his/her designee, shall release the portion of the financial guarantee established under this Section to assure maintenance of stormwater practices, less any costs incurred by the City.

36.12 FEE SCHEDULE

The fees referred to in this Chapter shall be established by Resolution of the Common Council and may from time to time be modified by Resolution. A schedule of the fees established by the Common Council shall be available for review in the Office of the Director of Public Works.

36.13 ENFORCEMENT

A. Violations. Any land-disturbing construction activity or post-construction runoff initiated after the effective date of this Chapter by any person, firm, association or corporation subject to the Chapter provisions shall be deemed a violation, unless conducted in accordance with the requirements of this Chapter.

B. Notification of Violation(s). The Director of Public Works, or designee thereof, shall notify the responsible party **in writing** of noncomplying land-disturbing construction activity or post-construction runoff. The notice shall describe the nature of the violation, remedial actions needed, a schedule for remedial action, and additional enforcement action which may be taken.

C. Corrective Action. Upon receipt of written notification for the Director of Public Works, or his/her designee, under Subsection B., the responsible party shall correct work that does not comply with the Stormwater Management Plan or other provisions of this Chapter. The responsible party shall make corrections as necessary to meet the specifications and schedule set forth by the Director of Public Works, or his/her designee, in the notice.

D. Damage Caused By Violations. If the violations to a permit issued pursuant to this Chapter are likely to result in damage to properties, public facilities, or waters of the State, the parties working under the direction and authority of the Director of Public Works, or his/her designee, may enter the land and take emergency actions necessary to prevent such damage. The costs incurred by the City, plus interest and legal costs, shall be billed to the responsible party.

E. Stop Work Order. The Director of Public Works, or his/her designee, is authorized to post a Stop Work Order on all land-disturbing construction activity that is in violation of this Chapter, or to request the City Attorney obtain a Cease and Desist Order in any court with jurisdiction.

F. Permit Revocation For Noncompliance. The Director of Public Works, or his/her designee, may revoke a permit issued under this Chapter for noncompliance with Chapter provisions.

G. Continuing Nature of Orders. Any permit revocation, Stop Work Order, or Cease and Desist Order shall remain in effect unless retracted by the Director of Public Works, or his/her designee, or by a

court with jurisdiction.

H. Legal Proceedings. The Director of Public Works, or his/her designee, is authorized to refer any violation of this Chapter, or of a Stop Work Order or Cease and desist Order issued pursuant to this Chapter, to the City Attorney for the commencement of further legal proceedings in any court with jurisdiction.

I. Penalties. Any person, firm, association or corporation who does not comply with the provisions of this Chapter shall be subject to a forfeiture of not less than Five (\$5.00) Dollars, nor more than Five Hundred (\$500.00) Dollars per offense, together with the costs of prosecution. Each day that the violation exists shall constitute a separate offense.

J. Injunction. Compliance with the provisions of this Chapter may also be enforced by injunction in any court of competent jurisdiction. It shall not be necessary to prosecute for forfeiture or a Cease or Desist Order before resorting to injunctive proceedings.

K. City Make Take Direct Action To Obtain Compliance. When the Director of Public Works, or his/her designee, determines that the holder of a permit issued pursuant to this Chapter has failed to follow practices set forth in the Stormwater Management Plan, or has failed to comply with the schedule set forth in said Stormwater Management Plan, parties working under the direction and authority of the Director of Public Works, or his/her designee, may enter upon the land and perform the work or other operations necessary to bring the condition of said lands into conformance with the requirements of the approved plan. The Director of Public Works, or his/her designee, shall keep a detailed accounting of the costs and expenses of performing this work. These costs and expenses shall be deducted from any financial security posted pursuant to Section 36.11 of this Chapter. Where such a security has not been established, or where such a security is insufficient to cover these costs, the costs and expenses shall be entered on the tax roll as a special charge against the property and collected with any other taxes levied thereon for the year in which the work is completed.

36.14 APPEALS

A. Appeals Before The Stormwater Utility Committee. The Stormwater Utility Committee of the City of Kenosha shall hear and decide appeals where it is alleged that there is error in any order, decision or determination made by the Director of Public Works, or his/her designee, in administering this Chapter. The Committee shall also use the rules, procedures, duties and powers authorized by Statute in hearing and deciding Appeals. Upon appeal, the Committee may authorize variances from the provisions of this Chapter that are not contrary to the public interest, and where owing to special conditions, a literal enforcement of the Ordinance will result in unnecessary hardship.

B. Who May Appeal. Appeals to the Stormwater Utility Committee of the City of Kenosha may be taken by any aggrieved person, or by an officer, department, board or bureau of the City affected by any decision of the Director of Public Works, or his/her designee.

C. Severability. If any section, clause, provision or portion of this Chapter is judged unconstitutional or invalid by a court of competent jurisdiction, the remainder of the Chapter shall remain in force and not be affected by such judgment.

CHAPTER XXXVII
ILLCIT STORMWATER DISCHARGES AND CONNECTIONS

- 37.01 Authority
- 37.02 Findings and Purpose
- 37.03 Administration
- 37.04 Applicability of Code
- 37.05 Definitions
- 37.06 Prohibitions
- 37.07 Suspension of Illicit Discharges
- 37.08 Monitoring
- 37.09 Presentation With BOPS
- 37.10 Notification of Spills
- 37.11 Enforcement
- 37.12 Appeals
- 37.13 Severability

37.01 AUTHORITY

This Ordinance is adopted under the authority granted by Section 62.234, Wisconsin Statutes, that relates to illicit discharges of stormwater and illicit connections. Except as otherwise specified in Section 62.234, Wisconsin Statutes, Section 62.23, Wisconsin Statutes, applies to this Ordinance and to any amendments thereto.

A. Regulatory Powers. The provisions of this Ordinance are deemed not to limit any other lawful regulatory powers of the same governing body.

B. Stricter Requirements. The requirements of this Ordinance do not preempt more stringent illicit stormwater discharge and connection requirements that may be imposed by any of the following:

1. Wisconsin Department of Natural Resources administrative rules, permits or approvals, including those authorized under Subsections 281.16 and 283.33, Wisconsin Statutes.
2. United States Environmental Protection Agency administrative rules, permits or approvals.

37.02 FINDINGS AND PURPOSE

A. Findings. The City of Kenosha's Separate Storm Sewer Systems (MS4) are municipally-owned facilities where stormwater is collected and/or conveyed, including, but not limited to, any roads with drainage systems, municipal streets, gutters, curbs, inlets, piped storm drains, pumping facilities, infiltration and detention basins, natural and unnatural or altered drainage channels, reservoirs, and other drainage structures.

The Common Council finds illicit discharges can carry pollutants to the waters of the State through its MS4s.

B. Purpose. The purposes of this Ordinance are:

1. To provide for the health, safety, and general welfare of the citizens of the City of Kenosha through the regulation of non-stormwater discharges to the storm drainage system to the maximum extent practicable as required by Federal and State law;

2. To reduce the amount of pollutants entering the City's Municipal Separate Storm Sewer System and the waters of the State from the City of Kenosha by prohibiting illicit connections and discharges of stormwater;
3. To establish methods to comply with requirements of the National Pollutant Discharge Elimination System (NPDES) permit process;
4. To protect spawning grounds, and fish and aquatic life;
5. To preserve scenic beauty;
6. To promote sound economic growth by minimizing the amount of pollutants illicitly discharged to waters of the State in the City of Kenosha; and,
7. To establish legal authority to carry out all inspection, surveillance and monitoring procedures necessary to ensure compliance with this Ordinance.

37.03 ADMINISTRATION

The provisions of this Ordinance shall be administered and enforced by the Director of Public Works for the City of Kenosha, Wisconsin, or his/her designee.

37.04 APPLICABILITY OF CODE

A. Applicability. This Ordinance applies to all water entering the MS4 generated on any developed and undeveloped lands unless explicitly exempted by the City.

B. Nonapplicability. This Ordinance is not applicable to activities conducted by a State agency, as defined in Section 227.01(1), Wisconsin Statutes. This shall include:

1. The Office of the District Attorney, which is subject to the State plan promulgated or a memorandum of understanding entered into under Section 281.33(2), Wisconsin Statutes.
2. The Wisconsin Department of Transportation (WisDOT) that entered into a memorandum of understanding with the Wisconsin Department of Natural Resources that satisfies Section 281.33(2), Wisconsin Statutes, such that activities directed and supervised by WisDOT are exempt from this Ordinance.

C. Minimum Standards. The standards set forth herein and promulgated pursuant to this Ordinance are minimum standards; therefore, this Ordinance does not intend nor imply that compliance by any person will ensure that there will be no contamination, pollution, nor the unauthorized discharge of pollutants.

D. WPDES Stormwater Discharge Permit Compliance. Any person subject to an industrial or construction activity WPDES Stormwater Discharge Permit shall comply with all the provisions of such permit. Proof of compliance with said permit may be required in a form acceptable to the Director of Public Works prior to allowing discharges to the MS4.

E. Jurisdiction. This Ordinance applies to waters and lands within the boundaries and jurisdiction of the City of Kenosha, as well as the extraterritorial division of land subject to an Ordinance enacted pursuant to Sections 236.45(2) and (3), Wisconsin Statutes.

36.05 DEFINITIONS

Best Management Practice (BMP) means structural or nonstructural measures, practices, techniques or devices employed to avoid or minimize soil, sediment or pollutants carried in runoff to waters of the State.

Business Day means a day the office the Department of Public Works is routinely and customarily open for business.

Cease and Desist Order means a Court issued order to halt illicit stormwater discharge or connection activity that is being conducted.

Construction Activity means activities subject to Erosion Control and Post-Construction Stormwater Permits.

Erosion means the process by which the land's surface is worn away by the action of wind, water, ice or gravity.

Hazardous Materials means any material, including any substance, waste, or combination thereof, which because of its quantity, concentration, or physical, chemical, or infectious characteristics may cause, or significantly contribute to, a substantial present or potential hazard to human health, safety, property, or the environment when improperly treated, stored, transported, disposed of, or otherwise managed.

Illegal Discharge means any direct or indirect non-stormwater discharge, regardless of intentionality, to the MS4 or to a privately maintained retention basin, except as exempted in this Ordinance. Indirect non-stormwater discharge includes discharges into watercourses or onto driveways, sidewalks, parking lots or other areas that drain into the MS4. Direct non-stormwater discharge includes deposition of solids, including, but not limited to grass, directly into the MS4.

Illicit Connection is defined as either of the following:

- ◆ Any drain or conveyance, whether on the surface or subsurface, that allows an illegal discharge to enter the MS4. This includes, but is not limited to, any conveyances that allow any non-stormwater discharge, including sewage, process wastewater, and wash water to enter the MS4 and any connections to the MS4 from indoor drains and sinks, regardless of whether said drain or connection had been previously allowed, permitted, or approved by an authorized enforcement agency.
- ◆ Any drain or conveyance connected from a commercial or industrial land use to the MS4 that has not been documented in plans, maps, or equivalent records and approved by an authorized enforcement agency.

Industrial Activity means activities subject to WPDES Industrial Permits as defined in 40 CFR, Section 122.26(b)(14) or subject to State of Wisconsin Administrative Code NR 216.20.

MEP or Maximum Extent Practicable means a level of implementing best management practices in order to achieve a performance standard specified in this Chapter which takes into account the best available technology, cost effectiveness and other competing issues, such as human safety and welfare, endangered and threatened resources, historic properties and geographic features. MEP allows flexibility in the way to meet the performance standards and may vary based on the performance standard and site conditions.

MS4 or Municipal Separate Storm Sewer System means municipally owned facilities where stormwater is collected and/or convey, including, but not limited to, any roads with drainage systems, municipal streets, gutters, curbs, inlets, piped storm drains, pumping facilities, retention and detention basins, natural and manmade or altered drainage channels, reservoirs, and other drainage structures.

Non-Stormwater Discharge means discharge to the MS4 that is not composed entirely of stormwater.

Performance Standard means a narrative or measurable number specifying the minimum acceptable outcome for a facility or practice.

Permit means a written authorization made by the Director of Public Works to the applicant to conduct land-disturbing construction activity or to discharge post-construction runoff to waters of the State.

Person means any individual, association, organization, partnership, firm, corporation or other entity recognized by law and acting as either the owner or owner's agent.

Pollutant has the meaning given in Section 283.01(13), Wisconsin Statutes, and means anything that causes or contributes to pollution. Pollutants may include, but are not limited to: paints, varnishes, and solvents; oil and other automotive fluids; nonhazardous liquid and solid wastes and yard wastes; refuse, rubbish, garbage, litter, or other discarded or abandoned objects, ordinances, and accumulations, so that same may cause or contribute to pollution; floatables; pesticides, herbicides, and fertilizers; hazardous

substances and wastes; sewage, fecal coliform and pathogens; dissolved and particulate metals; animal wastes; wastes and residues that result from constructing a building or structure; and noxious or offensive matter of any kind.

Pollution has the meaning given in Section 281.01(10), Wisconsin Statutes.

Stormwater Pollution Prevention Plan or SWPPP means a document that describes the BOPS and activities to be implemented by a person or business to identify sources of pollution or contamination at a site and the actions to eliminate or reduce pollutant discharges to stormwater, stormwater conveyance systems, and/or receiving waters to the maximum extent practicable.

Technical Standard means a document that specifies design, predicted performance, operation and maintenance specifications for a material, device or method.

Waters of the State has the meaning given in Section 281.01(18), Wisconsin Statutes.

Wisconsin Pollutant Discharge Elimination System (WPDES) Stormwater Discharge Permit means a permit issued by Wisconsin Department of Natural Resources (as authorized by the EPA under authority delegated pursuant to 33 U.S.C. §1342(b)) that authorizes the discharge of pollutants to waters of the United States, whether the permit is applicable on an individual, group, or general area-wide basis.

37.06 PROHIBITIONS

A. Discharge Prohibitions. No person shall cause, conduct, allow, or allow to continue, an Illegal Discharge.

B. Exemptions. Discharge to the MS4 of the following materials is not illegal:

1. Stormwater that is uncontaminated by pollutants or sedimentation.
2. Waterline flushing or other potable water sources, landscape irrigation or lawn watering, diverted stream flows; rising groundwater, groundwater infiltration to storm drains, uncontaminated pumped groundwater, foundation or footing drains (not including active groundwater dewatering systems), crawlspace pumps, air conditioning condensation, springs, noncommercial washing of vehicles, natural riparian habitat or wetland flows, swimming pools (if dechlorinated less than one ppm chlorine), firefighting activities, and any other water source not containing pollutants.
3. Discharges specified in writing by the authorized enforcement agency as being necessary to protect the public health and safety.
4. Dye testing is an allowable discharge, but requires a verbal notification to the authorized enforcement agency prior to the time of the test.
5. Any non-stormwater discharge permitted under a WPDES Permit, waiver, or waste discharge order issued to the discharger and administered under the authority of the Wisconsin Department of Natural Resources, provided that the discharger is in full compliance with all requirements of the permit, waiver, or order and other applicable laws and regulations, and provided that written approval has been granted for any discharge to the storm drain system.

C. Illicit Connections To Storm Drain System. The construction, use, maintenance or continued existence of illicit connections to the storm drain system is prohibited. This prohibition expressly includes, without limitation, illicit connections made in the past, regardless of whether the connection was permissible under law or practices applicable or prevailing at the time of connection.

D. Violation. A person is considered to be in violation of this Ordinance if the person connects a line conveying sewage to the MS4, or allows such a connection to continue.

37.07 SUSPENSION OF ILLICIT DISCHARGES

A. Suspension of MS4 Discharge Access. The City may, without prior notice, suspend MS4

discharge access to a person when such suspension is necessary to stop an actual or threatened discharge that presents or may present imminent and substantial danger to the environment, to the health or welfare of persons, to the MS4, or to waters of the State. If the violator fails to comply with a suspension order issued in an emergency, the City may take such steps as deemed necessary to prevent or minimize damage to the MS4 or waters of the State, or to minimize danger to persons.

B. Termination of MS4 Discharge Access. Any person discharging to the MS4 in violation of this Ordinance may have their MS4 access terminated if such termination would abate or reduce an illicit discharge. The Director of Public Works will notify a violator of the proposed termination of its MS4 access. The violator may petition the Director of Public Works for a reconsideration and hearing.

C. Reinstatement of MS4 Access Without Approval. A person commits an offense if the person reinstates MS4 access to premises terminated pursuant to this Section, without the prior approval of the Director of Public Works.

37.08 MONITORING

A. Applicability. This Section applies to all facilities that have stormwater discharges associated with industrial activity, including construction activity.

B. Access To Facilities.

1. The Director of Public Works, or his/her designee, shall be permitted to enter and inspect facilities subject to regulation under this Ordinance as often as may be necessary to determine compliance with this Ordinance. If a discharger has security measures in force that require proper identification and clearance before entry into its premises, the discharger shall make the necessary arrangements to allow access to the Director of Public Works or his/her designee.

2. Facility operators shall allow the Director of Public Works, or his/her designee, ready access to all parts of the premises for the purposes of inspection, sampling, examination and copying of records that must be kept under the conditions of a WPDES Permit to discharge stormwater, and the performance of any additional duties as defined by State and Federal law.

3. The City shall have the right to set up on any permitted facility such devices as are necessary in the opinion of the Director of Public Works to conduct monitoring and/or sampling of the facility's stormwater discharge.

4. The Director of Public Works has the right to require the discharger to install monitoring equipment as necessary. The facility's sampling and monitoring equipment shall be maintained at all times in a safe and proper operating condition by the discharger, at its own expense. All devices used to measure stormwater flow and quality shall be calibrated to ensure their accuracy.

5. Any temporary or permanent obstruction to safe and easy access to the facility to be inspected and/or sampled shall be promptly removed by the operator at the written or oral request of the Director of Public Works and shall not be replaced. The costs of clearing such access shall be borne by the operator.

6. Unreasonable delays in allowing the Director of Public Works, or his/her designee, to a permitted facility is a violation of a Stormwater Discharge Permit and of this Ordinance. A person who is the operator of a facility with a WPDES Permit to discharge stormwater associated with industrial activity commits an offense if the person denies the Director of Public Works, or his/her designee, reasonable access to the permitted facility for the purpose of conducting any activity authorized or required by this Ordinance.

7. If the Director of Public Works, or his/her designee, has been refused access to any part of the premises from which stormwater is discharged, and he/she is able to demonstrate probable cause to believe that there may be a violation of this Ordinance, or that there is a need to inspect and/or sample as part of a routine inspection and sampling program designed to verify compliance with this Ordinance, or any order issued hereunder, or to protect the overall public health, safety, and welfare of the community, then the Director of Public Works may seek issuance of a search warrant from any court of competent

jurisdiction.

37.09 PREVENTION WITH BMPS

A. BMP Identification Requirements. The City will adopt requirements identifying BMPs for any activity, operation, or facility that may cause or contribute to pollution or contamination of stormwater, the MS4, or waters of the State.

B. Protection From Accidental Discharge. The owner or operator of a commercial or industrial establishment shall provide, at their own expense, reasonable protection from accidental discharge of prohibited materials or other wastes into the municipal storm drain system or watercourses through the use of these structural and nonstructural BMPs. The Director of Public Works may require any person responsible for a property or premise that is, or may be the source of an illicit discharge to implement, at said person's expense, additional structural and nonstructural BMPs to prevent the further discharge of pollutants to the MS4.

C. Compliance. Compliance with all terms and conditions of a valid WPDES Permit authorizing the discharge of stormwater associated with industrial activity, to the maximum extent practicable, shall be deemed compliance with the provisions of this Section. These BMPs shall be part of a SWPPP as necessary for compliance with requirements of the WPDES Permit.

37.10 NOTIFICATION OF SPILLS

A. Notification of Release of Illegal Discharges or Pollutants Into Stormwater. Notwithstanding other requirements of law, as soon as any person responsible for a facility or operation, or responsible for emergency response for a facility or operation has information of any known or suspected release of materials that are resulting or may result in illegal discharges or pollutants discharging into stormwater, the MS4 or waters of the State, said person shall take all necessary steps to ensure the discovery, containment, and cleanup of such release.

In the event of such a release of hazardous materials, said person shall immediately notify emergency response agencies of the occurrence via emergency dispatch services.

In the event of a release of nonhazardous materials, said person shall notify the Director of Public Works in person or by telephone or facsimile no later than the next business day.

B. Written Notice Required. Notifications in person or by telephone shall be confirmed by written notice addressed and mailed to the Director of Public Works within three (3) business days of the telephone notice.

C. Written Record Required. If the discharge of prohibited materials emanates from a commercial or industrial establishment, the owner or operator of such establishment shall also retain an onsite written record of the discharge and the actions taken to prevent its recurrence. Such records shall be retained for at least three (3) years.

37.11 ENFORCEMENT

A. Notice of Violation. Whenever the City finds that a person has violated a prohibition or failed to meet a requirement of this Ordinance, the Director of Public Works may order compliance by written notice of violation to the responsible person.

B. Notice of Remediation/Restoration. If abatement of a continuing violation and/or restoration of an affected property is required, notice shall be given to the Responsible Person, which notice shall set forth a deadline within which such remediation or restoration must be completed. Said notice shall further advise that, should the violator fail to remedy or restore within the established deadline, the work will be done by a governmental agency or a contractor designated by the Director of Public Works, and the expense thereof shall be charged to the violator.

C. Abatement/Remediation At Violator's Expense. In addition to the enforcement processes and penalties provided, any condition caused or permitted to exist in violation of any of the provisions of this Ordinance is a threat to the public health, safety and welfare, and is declared and deemed a nuisance, and may be summarily abated or restored at the violator's expense, and/or a civil action to abate, enjoin, or otherwise to compel the cessation of such nuisance, may be taken. It is not necessary to prosecute for forfeiture, or issue a notice or order pursuant to this Chapter before instituting a civil action.

D. Penalty. Any person that has violated or continues to violate a provision of this Chapter shall, upon conviction, be subject to a forfeiture of not more than One Thousand (\$1,000.00) Dollars, in addition to all applicable costs, fees, surcharges, and assessments. Each day that such violation continues shall be considered a separate offense. In addition to other available alternative penalties, failure to pay said forfeiture and all applicable costs, fees, surcharges, and assessments shall subject the violator to a period in the County Jail of not more than ninety (90) days per offense. It is not necessary for notice of violation to be given prior to the issuance of a citation for violation of this Chapter.

E. Cost Recovery. The City may recover all attorney fees, court costs and other expenses associated with enforcement of this Ordinance, including sampling and monitoring expenses.

F. Remedies Not Exclusive. The remedies listed in this Section are not exclusive of each other or of any other remedies available under any applicable Federal, State or local law, and it is within the discretion of the City to seek cumulative remedies.

37.12 APPEAL

A. Notice of Appeal. Any person receiving a Notice of Violation may appeal the determination of the Director of Public Works to the City's Stormwater Utility Committee. The notice of appeal must be delivered to the Director of Public Works within ten (10) working days from the date of the Notice of Violation, who as soon as practicable, will forward the notice of appeal to the Stormwater Utility Committee. Hearing on the appeal shall take place within thirty (30) working days from the date of receipt of the notice of appeal.

B. Abatement. If the violation has not been corrected pursuant to the requirements set forth in the Notice of Violation; or, in the event of an appeal, within ten (10) working days of the Stormwater Utility Committee's decision to uphold the original decision, then representatives of the Director of Public Works shall enter upon the subject private property and are authorized to take any and all measures necessary to abate the violation and/or restore the property. It shall be unlawful for any person, owner, agent or person in possession of any premises to refuse to allow the Director of Public Works, or his/her designee, or designated contractor, to enter upon the premises for the purposes set forth above.

C. Costs of Abatement/Special Assessments. Within sixty (60) working days after abatement of the violation, the Director of Public Works will notify the owner of the property of the cost of abatement, including administrative costs. The property owner may file a written protest objecting to the amount of the assessment within ten (10) working days. If the amount due is not paid within a timely manner as determined by the decision of the Director of Public Works or by the expiration of the time in which to file an appeal, and the costs of abatement or restoration may be directly associated to a particular parcel for

which the responsible party is the violator, the costs shall become a special assessment against the property and constitute a lien on the property for the amount of the assessment.

D. Alternative Compensatory Actions. In lieu of enforcement proceedings, penalties, and remedies authorized by this Ordinance, the Director of Public Works may impose upon a violator alternative compensatory actions, such as storm drain stenciling, attendance at compliance workshops, watercourse cleanup, etc.

37.13 SEVERABILITY

If a court of competent jurisdiction judges any section, clause, provision or portion of this Ordinance unconstitutional or invalid, the remainder of the Ordinance shall remain in force and not be affected by such judgment.

CHAPTER XXXVIII
KENOSHA HERITAGE

38.01 PRESERVATION OF HISTORICAL ARTIFACTS

A. Purpose. The purpose of this section is to promote the general welfare by providing for the identification, protection, enhancement, perpetuation, and use of artifacts that reflect special aspects of the City's historical, architectural, cultural, or aesthetic heritage for the following reasons:

1. To encourage public knowledge, understanding, and appreciation of the City's past;
2. To foster civic pride in the beauty and character of the City and the accomplishments of its past;
3. To preserve the visual character of the City by preserving artifacts that reflect its history, and
4. To preserve positive, tangible aspects that are unique to the City.

B. Definitions.

1. Commission for the purposes of this section means the Historic Preservation Commission.
2. Artifacts for the purposes of this section are manmade objects of cultural or historical significance that are located or have been displayed within the City.
3. Object. Means an item that is:
 - a. by nature of design moveable;
 - b. a structure that was not designed to be habitable; or
 - c. an aesthetic feature of a structure, regardless of whether the structure is habitable, that may be removed from the structure or obliterated, without significant structural damage to the structure.
4. Historical artifact means an artifact that is:
 - a. A local historical artifact that is at least 50 years old; or
 - b. Associated with a property that meets the criteria for listing on the National Register of Historic Places, State Register of Historic Places or as a city landmark.
5. Inventory of historical artifacts is the official list of historical artifacts subject to the terms of this section. The inventory of historical artifacts shall be held and maintained by the Director of the Department of City Development.
6. Local historical artifact is an object that:
 - a. Exemplifies or reflects the cultural, archaeological, political, economic, social, or religious history; or
 - b. Is identified with personages, events, or periods of history which personages, events, or periods are significant to the community; or
 - c. Embodies distinguishing characteristics of architecture, an architect, architectural materials, craftsmanship, or works of nature; or
 - d. In its inherent historical nature provides the citizenry with educational or aesthetic enrichment; or
 - e. Contributes to the character or understanding of an historic district, property, or structure.

C. Procedures for listing or removal from listing. Official listing on the inventory of historical artifacts, or removal from listing, shall be made by recommendation of the Commission and confirmation by the Common Council.

1. The Commission shall hold a public hearing before recommending that an artifact be listed, or removed from listing, on the inventory of historical artifacts. At least ten days prior to the hearing, the Commission shall in good faith provide written notice to the following:
 - a. The Director of the Kenosha Public Museum
 - b. The Director of the Department of City Development.

- c. The Director of Public Works.
- d. The General Manager of the Water Utility.
- e. The Fire Chief
- f. The Police Chief
- g. The Mayor and Alderpersons
- h. The owner of the historical artifact or proposed historical artifact.

2. After giving notice as provided in paragraph C.1., the Commission shall conduct the public hearing. The Commission shall have the power to call such other witnesses and to examine such records as it deems necessary.

3. Within 30 days after the close of the public hearing, the Commission shall recommend or decline to recommend to the Common Council the listing, or removal from listing, of the artifact on the inventory of historical artifacts. At least ten days prior to the final recommendation, the Commission shall in good faith provide written notice to those listed in C.1 a. through C.1.h. above.

4. The Common Council shall act upon the recommendation of the Commission. The Common Council may not place the artifact on the inventory of historical artifacts if prior to the Common Council's determination, an objection to the listing is made by the owner of the artifact.

D. Preservation.

1. No person or entity, including but not limited to, any department or agency of the City or the Redevelopment Authority of the City of Kenosha, may permit the transfer, relocation, demolition, obliteration, or alteration of an historical artifact listed on the inventory of historical artifacts without first obtaining the permission of the Commission. If any activity associated with the historical artifact has the potential to damage or cause the loss of such historical artifact, the person responsible for such activity must first present a plan for the protection of such historical artifact to the Commission. The project may not commence or continue until and unless the historical artifact protection plan is approved. The person responsible for the activity must thereafter provide documentation to the Commission, the Director of Public Works, the Director of the Department of City Development, the General Manager of the Water Utility, the Police Chief, or the Fire Chief under whose control and custody the listed historical artifact falls, that the plan was properly executed.

2. If approval under paragraph D.1. is denied, the applicant may, in writing to the City Clerk within ten days of denial, appeal such decision to the Common Council. The City Clerk shall cause the matter to be placed on the agenda of the meeting of the Common Council next following the receipt of such appeal, consistent with the 24-hour notice provision of the Wisconsin Open Meetings Law. A representative of the Commission shall appear at such meeting to explain the reasons for denial. Approval or denial by the Common Council is final.

E. Documentation. If the Commission finds that the preservation of an historical artifact is not practicable, then the historical artifact shall be documented by photographs, mapping, written description, or such other means or matter deemed most appropriate by the Commission.

F. Stop Work Order. If any member of the Commission learns or discovers that any person or entity is, may be, or is about to be engaged in the transfer, relocation, demolition, or alteration of a historical artifact listed on the inventory of historical artifacts without first obtaining the permission of the Commission, such Commission member shall notify the Chair of the Commission. The Commission Chair shall call a special meeting, to be held within three days (Saturdays, Sundays, and holidays excluded for calculation purposes, but such meeting could be held on a Saturday or Sunday) consistent with the Wisconsin Open Meetings Law, by providing telephonic or written notice to each member of the Commission at his/her usual place of abode at least six hours before the time set for the meeting. No business shall be transacted or action taken at any special meeting other than the prospective stop work order stated in the notice for the meeting. If the Commission issues a stop work order, such order shall in place remain until confirmed, modified, or overruled by the Common Council at a regularly scheduled meeting.

G. Cooperation with Other Public Entities. The Historic Preservation Commission shall work with other public entities, including, but not limited to, the Kenosha Unified School District, Gateway Technical College, County of Kenosha, and State of Wisconsin to extend the protection of this section to historical objects that they own.

H. Penalties. It shall be a violation of this Section for any person, party, firm or corporation, or limited liability company or partnership to violate the provisions of Paragraph D.1. or Subsection F. Upon conviction, except as otherwise provided, a violator shall be subject to forfeiture of not more than One Thousand (\$1,000) Dollars for each violation, plus the costs of prosecution.

INDEX

Abandoned & Unclaimed Property	I - 32
Aboveground Utility Structures..	XV - 7
Definition of..	XV - 7
Exemptions..	XV - 7
Prohibitions..	XV - 7
Signs on.	XV - 7
Absentee Ballots.	I - 28
Absentee Ballot Canvassers, Board of..	I - 21
Canvassing of..	I - 28
Accessory Building	
Definition..	XVI - 1
Structures.	XVI - 17
Acrobatic Flying Prohibited..	XVIII - 5
Adult Uses, Minors Prohibited.	XI - 15
Aeronautical Services (Commercial), Short Term Permits.	XXV - 20
Air Cargo Operator..	XXV - 12
Air Conditioners - Noise.	XXIII - 5
Air Conditioning Equipment; Location of.	IX - 14
Aircraft Charter and Air Taxi Operator.	XXV - 11
Aircraft Fuel Dispensing Operator.	XXV - 9
Aircraft Operations, Regulation of.	XVIII - 4
Aircraft Rental Operator..	XXV - 7
Aircraft Repair Operator, Specialized..	XXV - 15
Aircraft Sales Operator.	XXV - 16
Airframe and Power Plant Operator..	XXV - 6
Airport Approach Protection..	XVIII - 5
Airport Development Code..	XVIII - 2
Airport, Kenosha Regional.	XVIII - 1, XXV - 1
Airport Approach Protection.	XVIII - 5
Airport Commission.	XVIII - 2
Airport Development Code.	XVIII - 2
Buildings.	XVIII - 3
Definitions..	XVIII - 1
Leases, Concessions & Contracts.	XVIII - 3
Ordinance Enforcement.	XVIII - 5
Personal Property Storage.	XVIII - 4
Regulations, Aircraft Operations..	XVIII - 4
Rights/Privileges..	XXV - 2
Vehicular Traffic.	XVIII - 4
Alcohol Beverages.	X - 1
Business Separation..	X - 6
Closing Hours, Class "A" Premises.	X - 2
Definitions..	X - 1
Delivery of Liquor.	X - 7
Intoxicating Liquor License.	X - 1

CODE OF GENERAL ORDINANCES, 2021 - KENOSHA, WISCONSIN

License Investigation.....	X - 2
License; Fees.	X - 1
Licenses, Limitation as to Number.	X - 5
Open For Business - Suspension..	X - 8
Operational Requirements.	X - 7
Outdoor Dining Area..	V - 11
Outdoor Extension Permit.	X - 15
Parks.	X - 1
Patrons Off-Premise Conduct.	X - 12
Regulations..	X - 7
Statutes, Adoption of.	X - 1
Unobstructed View of Interior Premises	X - 17
Wholesalers.	X - 6
Aldermanic Vacancies.	I - 2
All Terrain Vehicles	
Prohibited on Sidewalks.	VII - 32
Regulation of.	XI - 17
Alley Vacations..	V - 5
Alleys.	V - 2
Clean By Responsible Party.	V - 25
Lighting/Paving of.	V - 5
Partial Vacations..	V - 5
Alleys; Vacated Alleys.	XVI - 16
Alternate Street Parking..	VII - 7
Ambulance & Rescue Service, Emergency.	III - 3
Amusement and Recreation Enterprises.	XII - 1
Dance, Public.	XII - 1
Definitions..	XII - 1
Demerit Points.	XII - 2
Disciplinary Hearings.	XII - 2
License Revocation, NonRenewal, Suspension	XII - 2
Licenses Required.	XII - 1
Off Premises Conduct.	XII - 4
Pool Hall.	XII - 1
Regulations, Premises.	XII - 3
Skating Rink.	XII - 1
Supervisor License..	XII - 1
Angle Parking..	VII - 9
Animal Drawn Vehicles.	XIV - 11
Animals in Park.	VI - 2
Animals Prohibited.	XIV - 7
Animals, Birds and Fowl..	XIV - 1
Animals Prohibited.	XIV - 7
Baby Chicks, Sale of.	XIV - 11
Cruelty to Animals..	XIV - 12
Definitions..	XIV - 1
Dogs an Cats.	XIV - 1

CODE OF GENERAL ORDINANCES, 2021 - KENOSHA, WISCONSIN

Ducklings, Sale of	V - 11
Fowls Regulated..	XIV - 7
Impounding..	XIV - 2
Kennels; Pet Shops.	XIV - 3
Limitation on Number of.	XIV - 2
Rabbits, Sale of.	XIV - 11
Rabies Control.	XIV - 12
Sanitary Conditions, Maintenance of.	XIV - 3
Sanitation.	XIV - 11
Wild Animal.	XIV - 7
Annexation Ordinances.	I - 31
Appliances, Fuel Burning	
Combustion Air.	XVI - 25
Safety Controls.	XVI - 25
Art Donations, Public.	I - 39
Arterial Street	
Definition of.	XVII - 2
Assault.	XI - 1
Assessments, Special.	II - 4
Audit, City Accounts.	II - 3
Automatic Telephone Dialing Device.	XI - 15
Aviation, Commercial & Industrial Areas.	XVIII - 2
Baby Chicks, Ducklings & Rabbits, Sale of	XIV - 11
Balconies.	XVI - 18
Balloons, Hot Air.	XVIII - 5
Balloons, Tethered.	XV - 3
Banners.	XV - 5
Banners, Signs, Decorations & Obstructions.	V - 6
Basements	
Bedrooms.	XVI - 22
Hatchways.	XVI - 19
Window Guards.	XVI - 19
Bathrooms.	XVI - 1, XVI - 24
Battery.	XI - 2
Beaches.	VI - 2
Floating Devices/Toys in Water.	VI - 2
Lifeguards Off Duty.	VI - 3
Protection of.	VI - 7
Watercraft.	VI - 3
Bells/Chimes - Noise	XXIII - 6
Bicycle/Tricycle/Unicycle.	VII - 28
Child Carriers.	VII - 29
Equipment Required.	VII - 29
Operate w/o Owner's Consent.	VII - 30
Registration.	VII - 28
Regulations.	VII - 28
BMP Design Criteria/Standards/Specifications	XXXIII - 3

CODE OF GENERAL ORDINANCES, 2021 - KENOSHA, WISCONSIN

BMP [Best Management Practice].....	XXXVII - 2
Accidental Discharge, Protection From	XXXVII - 5
Identification Requirements.	XXXVII - 4
Boards, Commissions, Authorities, Committees	I - 17
Absentee Ballot Canvassers, Board of.. ..	I - 21
Airport Commission.	XVIII - 2
Assessors, Board of.	I - 26
Board of Housing Appeals.	I - 39
Board of Review.	I - 25
Citizens, Terms of.. ..	I - 21
City Plan Commission.	I - 18
Community Development Block Grant Committee.. ..	I - 26
Eligibility For.	I - 17
Emergency Government Committee.	I - 29
Employee Involvement Committee.. ..	I - 34
Harbor Commissioners, Board of.. ..	XIX - 1
Home Program Commission.	I - 25
Human Relations Commission.. ..	I - 18
Keep Kenosha Beautiful Commission.	I - 23
Kenosha Transit Commission.	I - 19
Legislative Commission.	I - 22
Library Board.	I - 18
Marina Commission.	XIX - 1
Mayor's Youth Commission.	I - 24
Museum Board.. ..	I - 18
Park Commissioners, Board of.. ..	I - 21
Police & Fire Commissioners, Board of.	I - 18
Public Works, Board of.. ..	I - 21
Residency Requirements.	I - 35
Water Commissioners, Board of.	I - 21
Women's Issues Commission.	I - 22
Zoning Appeals, Board of.. ..	I - 18
Boat Launching and Mooring.	XIX - 4
Boating Regulations.. ..	XIX - 2
Bond; Treasurer's.. ..	II - 3
Bonds & Oaths, Official.	I - 27
Boulevards.	VI - 7
Budget.	II - 1
Accounts and Audit.. ..	II - 3
Business Improvement Districts.	II - 9
Capital Improvement Plan.	II - 2
Claims.. ..	II - 3
Disbursements.	II - 3
Building Code.. ..	IX - 1
Air Conditioning Equipment Location.	IX - 14
Appeals.. ..	IX - 16
Building Permit Application.. ..	IX - 3

CODE OF GENERAL ORDINANCES, 2021 - KENOSHA, WISCONSIN

Code Official, Duties of	X - 2
Construction	IX - 4
Construction Time Periods.....	IX - 4
Definitions.....	IX - 1
Downspout Discharge.....	IX - 15
Electrical Wiring & Equipment.....	IX - 12
Existing Buildings.....	IX - 8
Fees.....	IX - 5
HVAC.....	IX - 14
Impact Fees.....	IX - 5
Inspections.....	IX - 6
Moving Buildings.....	IX - 9
One & Two Family Dwellings.....	IX - 7
Permit Exemptions.....	IX - 4
Permits.....	IX - 4
Plumbing Qualifications.....	IX - 12
Razing Buildings.....	IX - 10
Reinspection Fees.....	IX - 5
Retaining Walls.....	IX - 15
Scope of.....	IX - 2
State Statutes/Administrative Codes.....	IX - 2
Unsafe Buildings.....	IX - 8
Vacant Buildings.....	IX - 9
Violations.....	IX - 16
Building Permits	
Application.....	IX - 3
Construction.....	XVII - 18
Construction	IX - 4
Permit Exemptions.....	IX - 4
Plan Submission.....	IX - 3
Surveys.....	IX - 3
Buses, Nonpayment of Fares.....	XI - 14
Business Licenses.....	XIII - 1
Business Park of Kenosha - Signs.....	XV - 5
Cabaret License.....	X - 14
Cable T.V.....	XXVI - 1
Award of Franchise.....	XXVI - 2, XXVI - 3
Construction/Technical Performance Standards	XXVI - 5
Definitions.....	XXVI - 1
Franchise Applicability/Administration	XXVI - 2
Franchise Required.....	XXVI - 2
Grantee Right/Privilege in Street.....	XXVI - 2
Interpretation of Defined Terms.....	XXVI - 2
Newly Developing Areas.....	XXVI - 5
Peg Access.....	XXVI - 6
Programming.....	XXVI - 6
Removal of System Infrastructure.....	XXVI - 8

CODE OF GENERAL ORDINANCES, 2021 - KENOSHA, WISCONSIN

Service Availability	I - 5
Service Complaint Procedure.....	XXVI - 6
System Construction & Extension Policy	XXVI - 5
Theft of Service.....	XI - 12, XXVI - 8
Use of Streets.....	XXVI - 5
Cable T.V. Franchise	
Award of Franchise.....	XXVI - 3
Certificates of Insurance.....	XXVI - 4
City Right of Acquisition.....	XXVI - 7
Construction Assurance.....	XXVI - 4
Costs of Award.....	XXVI - 3
Disclosure.....	XXVI - 6
Foreclosure; Receivership.....	XXVI - 7
Franchise Fee.....	XXVI - 6
Indemnity & Hold Harmless.....	XXVI - 4
Irrevocable Letter of Credit; Cash Security Deposit.....	XXVI - 4
Law, Compliance with.....	XXVI - 5
Liability Disclaimer.....	XXVI - 4
Liability Insurance Required.....	XXVI - 4
Other Cable Systems.....	XXVI - 7
Ownership Transfer.....	XXVI - 6
PEG Access Charges/Costs.....	XXVI - 6
Police Powers.....	XXVI - 3
Proposal, City Review of.....	XXVI - 3
Removal of System Infrastructure.....	XXVI - 8
Renewal of Franchise.....	XXVI - 3
Request for Proposals.....	XXVI - 3
Rules & Regulations of Grantee.....	XXVI - 6
Service Complaint Procedure.....	XXVI - 6
Subscribers' Rights.....	XXVI - 5
Termination for Breach.....	XXVI - 7
Campaign Contributions - Ethics.....	XXX - 2
Canopy Installation.....	XV - 5
Capital Improvement Plan.....	II - 2
Carnivals.....	XII - 5
License/Fee.....	XII - 5
Requirements.....	XII - 5
Cats.....	XIV - 1
Collar Tag/Computer Microchip.....	XIV - 1
Impounding.....	XIV - 2
License.....	XIV - 1
License and Rabies Tags.....	XIV - 4
Limitation on Number of.....	XIV - 2
Rabies Vaccination.....	XIV - 12
Run At Large.....	XIV - 2
Unvaccinated Cats.....	XIV - 14
Cement Batch Plants, Temporary.....	XIII - 7

CODE OF GENERAL ORDINANCES, 2021 - KENOSHA, WISCONSIN

Cemeteries, City Owned..... V - 29

Central Heating System..... XVI - 25

Certified Survey Map..... XVII - 11

Definition of..... XVII - 2

 Recordation of..... XVII - 12

 Review and Approval..... XVII - 8

 State Plane Coordinate System..... XVII - 12

Charitable, Religious & Political Solicitations..... XIII - 12

Chimneys..... XVI - 19

Christmas Trees, Sale of..... XIII - 24

Chronic Nuisance Property..... XVI - 13

 Injunction..... XVI - 14

 Nuisance Activity; Definition of..... XVI - 13

 Procedure..... XVI - 14

Cigarettes and Tobacco Products..... XI - 16

Circus, Menagerie, Etc..... XII - 5

 License/Fees..... XII - 5

 Parades..... XII - 5

City Departments..... I - 11

 Airport..... I - 14

 Assessment..... I - 15

 City Clerk/Treasurer..... I - 11

 City Development and Inspections..... I - 14

 Finance..... I - 12

 Fire Department..... I - 11

 Human Resources..... I - 14

 Law..... I - 13

 Municipal Court..... I - 15

 Parks..... I - 15

 Police Department..... I - 11

 Public Works..... I - 12

 Transportations..... I - 15

City Government..... I - 1

 Employee Involvement In..... I - 33

 Mayor..... I - 9

 Per Diem..... I - 1

 Records, Preservation & Destruction..... I - 32

 State Law, References to..... I - 32

City Management..... I - 11

 City Administrator..... I - 11

 Mayor..... I - 9, I - 11

City Property, Personal Use of..... XXX - 2

City Property-Commissions for Sale/Lease..... II - 6

Civil Service..... I - 28

Claims..... II - 3

Class "A"/"Class A" License..... X - 1

Class "B"/"Class B" License

CODE OF GENERAL ORDINANCES, 2021 - KENOSHA, WISCONSIN

Applications, Temporary Licenses	X - 6
Definition of.....	X - 1
Closing Hours - Class "B"/"Class B" Outdoor Area	X - 17
Closing Hours, Class "A" Premises.....	X - 2
Code Official	
Duties of.....	IX - 2
Right of Entry.....	IX - 3
Code Official	XVI - 4
Administration of Vacant Building Code	XXVIII - 3
Conduct of.....	XVI - 4, XXVIII - 3
Definition of.....	XVI - 2
Powers/Duties of.....	XVI - 4
Right of Entry.....	XVI - 5
Right of Entry- Vacant Bldg. Code	XXVIII - 3
Collector Street	
Definition of.....	XVII - 2
Combustible Materials.....	III - 7
Combustion Air.....	XVI - 25
Commercial Flying Operator.....	XXV - 14
Commercial Harbor.....	XIX - 1
Commercial Service Operators, Airport - Minimum Standards.....	XXV - 1
Air Cargo Operator.....	XXV - 12
Air Frame and Power Plant Operator	XXV - 6
Aircraft Charter and Air Taxi Operator	XXV - 11
Aircraft Fuel Dispensing Operator.....	XXV - 9
Aircraft Rental Operator.....	XXV - 7
Aircraft Repair Operator, Specialized	XXV - 15
Aircraft Sales Operator.....	XXV - 16
Definitions.....	XXV - 1
Fixed Base Operator.....	XXV - 4
Flight Training Operator.....	XXV - 8
Flying Club Operator.....	XXV - 19
Minimum Standards, Commercial Service Operators.....	XXV - 1
Multiple Services Operator.....	XXV - 17
Scheduled Air Carrier or Air Cargo Operator	XXV - 13
Self-Fueling Operator.....	XXV - 10
Short Term Permits.....	XXV - 20
Specialized Commercial Flying Operator	XXV - 14
T-Hangar, Common Hangar & Tie-Down Storage Operator.....	XXV - 18
Commercial Weighing.....	XXI - 2
Commodities, Method of Sale.....	XXI - 4
Commodity in Package Form.....	XXI - 1
Common Council.....	I - 1
Agenda.....	I - 7
Aldermanic Vacancies, How Filled.....	I - 2
Closed Sessions.....	I - 4
Committee on Finance.....	I - 6

CODE OF GENERAL ORDINANCES, 2021 - KENOSHA, WISCONSIN

Committee on License/Permits	I - 6
Committee on Public Works..	I - 6
Committee on Safety & Welfare..	I - 6
Composition of.	I - 1
Dress Code..	I - 4
Meetings of.	I - 3
Order of Business..	I - 4
Ordinances/Resolutions.	I - 8
Organization Meeting.	I - 3
Presiding Officer..	I - 5
Quorum	I - 4
Rules.	I - 4
Compulsory Retirement.	I - 28
Concessions - Airport..	XVIII - 3
Conditional Surrender-Alcohol Licenses.	X - 5, X - 9
Confidential-Exempt Records.	XXVII - 1
Construction	
As-Built Plans.	XVII - 19
Building Permits.	XVII - 18
Commencement of..	IX - 4
Inspection.	XVII - 19
Land Division.	XVII - 18
Plans..	XVII - 18
Site Safety Requirements..	IX - 5
Stop Work Order.	IX - 6
Time Extensions..	IX - 4
Work Completion Time Frames.	IX - 4
Construction Site Maintenance.	XXXIII - 1
Consumer Protection.	XXI - 1
Continuous Parking.	VII - 6
Contract/Lease Administration..	II - 1
Contracts - Airport.	XVIII - 3
Convenient Cash Business.	XIII - 15
Cruelty to Animals.	XIV - 12
Cul-de-Sacs.	XVII - 14
Curb and Gutter	
Improvements, Required.	XVII - 16
Repair of..	IX - 15
Curfew.	XI - 11
Dance, Public.	XII - 1
Deadbolt Locks.	XVI - 19
Decks..	XVI - 18
Permit Fee Waiver.	IX - 5
Demerit Points - Alcohol Licenses.	X - 10
Design Standards; Land Divisions	
Blocks.	XVII - 14
Cul-de-Sacs.	XVII - 14

CODE OF GENERAL ORDINANCES, 2021 - KENOSHA, WISCONSIN

Limited Access Highway I - 13
Lots.. XVII - 15
Railway Right-of-Way. XVII - 13
Street Design. XVII - 14
Street Trees. XVII - 17
Streets. XVII - 13
Traditional Neighborhood Development XVII - 16
Development Agreement. XVII - 17
Assurances. XVII - 18
Definition of. XVII - 2
Enforcement of. XVII - 18
Impact Fees. XVII - 17
Indemnity/Hold Harmless Agreements XVII - 18
Land Dedication. XVII - 17
Public Improvements, Acceptance of XVII - 17
Requirements/Responsibilities. XVII - 17
Directional/Information Sign.. XV - 5
Dirt Bikes
 Regulation of. XI - 17
Disability - Fair Housing. XXII - 1
Disbursements. II - 3
Discrimination - Fair Housing.. XXII - 1
Disorderly Conduct, Sec. 11.02. XI - 1
 Assault - 11.02F.. XI - 1
 Battery - 11.02 V.. XI - 2
 Begging - 11.02O.. XI - 2
 Bus-Smoke, Drink, Consume Food on - 11.02P. XI - 2
 Curfew - Sec. 11.05. XI - 11
 Delivery Personnel - 11.02Y.. XI - 3
 Drug Activity, Loitering - 11.034. XI - 10
 False Police Alarms - 11.029. XI - 7
 Fights - 11.02B.. XI - 1
 Fire Bombs, Possession of - 11.02R... XI - 2
 Firearms - 11.02A.. XI - 1
 Graffiti - 11.031.. XI - 7
 Hunting - 11.02T.. XI - 2
 Hunting, City Limits- 11.02T.. XI - 2
 Indecent Conduct - 11.02D.. XI - 1
 KPD Dogs, Abuse - 11.02S... XI - 2
 Language, Objectionable - 11.02E.. XI - 1
 Littering - 11.02U.. XI - 2
 Maltreat Person - 11.02K... XI - 1
 Mashing - 11.02 N.. XI - 2
 Meetings, Disturbance of - 11.02J... XI - 1
 Obstruct Firemen/Policemen - 11.02Q.. XI - 2
 Open Intoxicants - 11.026. XI - 5
 Peace, Disturbance of - 11.02M.. XI - 2

CODE OF GENERAL ORDINANCES, 2021 - KENOSHA, WISCONSIN

Prostitution, Loitering - 11.035.....	I - 10
Prowling-11.02G..	XI - 1
Restraining Order Violation - 11.02L.....	XI - 2
Retail Theft - 11.053..	XI - 4
Schools, Trespass On - 11.02X..	XI - 3
Snowballs - 11.02C..	XI - 1
Theft - 11.02W...	XI - 2
Vandalism - 11.02Z..	XI - 3
Violence, Incite - 11.02H..	XI - 1
Disorderly Houses.	XI - 7
Disturbance of Peace..	XI - 2
Dog Runs, Public.	XIV - 2
Dogs..	XIV - 1
Collar Tag..	XIV - 1
Control of	XI - 4
Impounding..	XIV - 2, XIV - 15
License and Rabies Tags..	XIV - 4
Limitation on Number of.	XIV - 2
Nuisance Barking.	XIV - 2
Public Dog Runs..	XIV - 2
Rabies Vaccination..	XIV - 12
Run At Large.	XIV - 2
Unvaccinated Dogs.	XIV - 14
Dogs, Control of - 11.024..	XI - 4
Doors.	XVI - 19
Downspout Discharge - Building Code.	IX - 15
Driveway Approaches.	V - 20
Application Denial..	V - 22
Bonds.	V - 12
Conditions/Criteria.	V - 20
Construction of.	V - 12
License and Permit..	V - 12
Permit.	V - 20
Repair of..	IX - 15
Specifications.	V - 12, V - 21
Driveways..	XVI - 16
Drug Activity, Loitering.	XI - 10
Dumpsters - Street Occupancy Of..	IX - 9
E-Mail Policy..	I - 38
Economic Interest, Statement of.	XXIX - 1
Efficiency Dwelling Unit.	XVI - 23
Egress, Means of.	XVI - 26
Elections	
Absentee Ballot Canvassers, Board of..	I - 21
Absentee Ballots..	I - 28
Aldermanic Vacancies.	I - 2
Campaign Contributions..	XXX - 2

CODE OF GENERAL ORDINANCES, 2021 - KENOSHA, WISCONSIN

Mayoral Vacancies.....	I - 2
Political Activity.....	XXX - 3
Poll Workers.....	I - 34
Polls, Hours Open.....	I - 28
Electrical Facilities & Equipment.....	XVI - 24
Hazards.....	XVI - 26
Installation.....	XVI - 26
Lighting Fixtures.....	XVI - 26
Prohibitions.....	XVI - 24
Receptacles.....	XVI - 26
Requirement.....	XVI - 25
Responsibility for.....	XVI - 24
Service.....	XVI - 25
Electrical Permit Exemptions.....	IX - 4
Electrical Service, Mandated De-Energization of.....	IX - 13
Electrical Service/Wiring.....	IX - 12
Energizing New/Temporary Service.....	IX - 13
Residential Wiring.....	IX - 13
Electrical Wiring/Equipment	
De-Energization of Electrical Service.....	IX - 13
Qualifications.....	IX - 12
Emergency Government.....	I - 28
Emergency Medical Service User Fees.....	II - 10
Emergency Signaling Devices - Noise.....	XXIII - 4
Emergency Vehicles.....	VII - 33
Employees - Background Checks.....	I - 41
Employees-Residency Requirement.....	I - 34
Endurance Contests.....	XI - 14
Energy Conservation Devices.....	XVI - 25
Environmental Cleanup Costs.....	II - 10
Erosion Control	
Land Division.....	XVII - 17
Erosion Control	
Permit Requirements.....	XXXIII - 5
Permits.....	XXXIII - 4
Requirements.....	XXXIII - 4
Erosion Control Code.....	XXXVI - 1
Administration of.....	XXXIII - 1
BMP Design Criteria/Standards/Specifications.....	XXXIII - 3
Definitions.....	XXXIII - 2
Ethical Conduct	
Campaign Contributions.....	XXX - 2
City Property, Personal use of.....	XXX - 2
Confidential Information.....	XXX - 2
Discrimination.....	XXX - 3
Gifts.....	XXX - 2
Government, Crimes Against.....	XXX - 2

CODE OF GENERAL ORDINANCES, 2021 - KENOSHA, WISCONSIN

Political Activity.....	XXX - 3
Public Contracts, Financial Transactions, Etc.....	XXX - 2
Quasi-Judicial Hearings.....	XXX - 3
Representing Private Interests.....	XXX - 3
Standards.....	XXX - 2
Ethics, Code of.....	XXX - 1
Complaints, Investigation of.....	XXX - 3
Definitions.....	XXX - 1
Ethical Conduct, Standards for.....	XXX - 2
Financial Disclosure.....	XXX - 3
Policy.....	XXX - 1
Excavations, Permit.....	V - 2
Excavations/Depressions.....	IX - 15
Building Excavations, Abatement of.....	IX - 16
Exceptions.....	IX - 16
Hazardous Depression, Abatement of	IX - 16
Exit Signs.....	III - 15
Explosives.....	III - 7
Exterior Premises.....	XVI - 15
Clean/Sanitary/Safe.....	XVI - 15
Nuisances, Free From.....	XVI - 16
Extermination.....	XVI - 21
Extraterritorial Jurisdiction	
Post-Construction Stormwater Management.....	XXXVI - 2
Extraterritorial Plat - Review/Approval.....	XVII - 8
Fair Housing.....	XXII - 1
Administration.....	XXII - 2
Definitions.....	XXII - 1
Policy.....	XXII - 1
Prohibited Acts.....	XXII - 1
False Fire Alarm.....	III - 6
False Police Alarms.....	XI - 7
Farmer Markets.....	XIII - 25
Establishment of.....	XIII - 25
Market Hours.....	XIII - 25
Regulations.....	XIII - 26
Scales.....	XIII - 25
Stalls, Assignment of.....	XIII - 25
Stalls, Rental Fee.....	XIII - 25
Federal Aviation Administration Regulations.....	XVIII - 5
Fermented Malt Beverages.....	X - 2
Financial Disclosure-City Officers & Employees.....	XXIX - 1
Fire	
Use of In Park.....	I - 1
Fire Alarms.....	III - 13
Key Box System Required.....	III - 17
Fire Drills.....	III - 5

CODE OF GENERAL ORDINANCES, 2021 - KENOSHA, WISCONSIN

Fire Extinguisher System.....	I - 16
Fire Extinguishing Equipment.	III - 5
Fire Hydrants.	III - 11, XXXII - 3, XXXII - 9
Fire Investigation.	III - 3
Fire Prevention.....	III - 1
Authority to Enter Premises.	III - 2
Automatic Fire Sprinkler Systems.	III - 8
Buildings Excepted.....	III - 2
Buildings, Structures & Premises Affected.....	III - 2
Bureau of.	III - 1
Closing/Vacating Buildings & Structures.	III - 3
Code Compliance Enforcement.....	III - 3
Code Provisions.....	III - 1
Combustible Materials, Maintenance/Storage of.....	III - 7
Duties.	III - 2
Education.	III - 5
Emergency Response Enclosures.....	III - 16
Exit Signs.	III - 15
Explosives.	III - 7
Fire Drills.	III - 5
Fire Extinguishing Equipment.....	III - 5
Fire Hydrants.	III - 11
Fire Investigations.	III - 3
Fire Prevention Code.....	III - 1
Fireworks.	III - 6
Hazardous Materials.....	III - 6
Notices.	III - 3
Open Burning.	III - 6
Parking Structures, Standpipes for.....	III - 17
Permanent Roof Anchorage Required.....	III - 16
Protection Systems.....	III - 13
Remedial Order.	III - 2
Standpipes.	III - 12
Storage Tanks.	III - 18
Fire Prevention	
Property Maintenance.....	XVI - 26
Fire Protections Closet.....	III - 16
Fire Safety Requirements.	XVI - 26
Egress, Means of.	XVI - 26
Enforcement.....	XVI - 26
Fire Doors.....	XVI - 27
Fire Protection Systems.....	XVI - 27
Ratings.	XVI - 27
Fuel Oil Tank Fire Resistance s.....	XVI - 27
Hazardous Materials.....	XVI - 27
Passageways, Unobstructed.....	XVI - 27
Prohibition.....	XVI - 26

CODE OF GENERAL ORDINANCES, 2021 - KENOSHA, WISCONSIN

Responsibility for I - 26
Smoke Barriers.. XVI - 27
Smoke Detectors. XVI - 27
Fire Sprinkler Systems.. III - 8
 Installation III - 9
Firewood Storage.. XVI - 17
Fireworks. III - 6
Fiscal Year. II - 1
Fixed Base Operator. XXV - 4
Flight Training Operator.. XXV - 8
Floor Surfaces. XVI - 20
Flying Club Operator. XXV - 19
Forester, City. XXXIV - 1
Forestry. XXXIV - 1
 Definitions.. XXXIV - 1
 Distance Limitations, Trees. XXXIV - 3
 Forestry Plan. XXXIV - 2
 Lawn Parks, Trees in. XXXIV - 3
 Permit. XXXIV - 2
 Public Right-of-Ways. XXXIV - 3
 Public Utility and Contractor Permits. XXXIV - 2
 Sidewalks. XXXIV - 3
 Special Assessment. XXXIV - 4, XXXIV - 8
 Standards, Tree Replacement. XXXIV - 7
 Tree Removal.. XXXIV - 3
 Trees, Protection of. XXXIV - 5
Fowl Regulated. XIV - 7
Fraud
 On Hotel Keeper.. XI - 4
 On Restaurant Keeper. XI - 5
 On Taxicab Operator. XI - 5
Freestanding Sign. XV - 4
Fuel Burning Appliances. XVI - 25
Fuel Oil Tanks. XVI - 27
Gambling. XI - 11
Graffiti.. XI - 7
Grass. XVI - 16
Handrails/Guardrails. XVI - 18, XVI - 20
Harassment Policy & Procedure. I - 35
Harbor Master. XIX - 4
Harbor, Kenosha Municipal. XIX - 1
 Boat Launching and Mooring. XIX - 4
 Commercial Harbor. XIX - 1
 Harbor Commissioners, Board of.. XIX - 1
 Harbor Master.. XIX - 4
 Impounding Moored Boats. XIX - 4
 Jurisdiction. XIX - 1

CODE OF GENERAL ORDINANCES, 2021 - KENOSHA, WISCONSIN

Marina Commission.....	X - 1
Navigation Obstructions.....	XIX - 3
Pierhead Line.....	XIX - 2
Regulations, Local.....	XIX - 2
Sailboat Basin.....	XIX - 1
Simmons Island Marina.....	XIX - 1
Southport Marina.....	XIX - 1
Hardship Exemption - Smoking in Restaurants/Grocery Stores.....	IV - 3
Hazardous Materials.....	III - 6, XVI - 27
Suppression Services, Fees For.....	III - 4
Hazardous Waste.....	XXXII - 25
Health.....	IV - 1
Administrator of.....	IV - 1
Penalties.....	IV - 3
Heating Facilities/Equipment.....	XVI - 25
Central Heating System.....	XVI - 25
Fuel Burning Appliances.....	XVI - 25
Heat Supply.....	XVI - 25
Residential Occupancies.....	XVI - 25
Heating Oil/Motor Fuel.....	XXI - 5
Heavy Vehicle Traffic and Parking.....	VII - 30
Historic Buildings.....	XVI - 4
Hood Systems [Fire Prevention].....	III - 16
Hookup Fees - Water Utility.....	XXXII - 4
Horse Drawn Vehicles.....	XIV - 10
Hotel-Motel Room Tax.....	II - 6
Hotel/Restaurant Keeper	
Fraud on.....	XI - 4
Housing Appeals, Board of.....	XVI - 10
Humane Officers	
Abatement Order, Issuance of.....	XIV - 16
Appointment of.....	XIV - 16
HVAC.....	IX - 14
Ignition Keys in Parked Cars.....	VII - 30
Illicit Stormwater Discharges/Connections	
Regulatory Powers.....	XXXVII - 1
Impact Fees.....	XXXV - 1
Appeal.....	XXXV - 3
Definitions.....	XXXV - 1
Development Agreement.....	XVII - 17
Manufactured/Mobile Home Parks.....	XX - 4
Payment of.....	XXXV - 2
Public Facilities Need Assessment.....	XXXV - 1
Reduction of.....	XXXV - 2
Revenues.....	XXXV - 2
Impounding Moored Boats.....	XIX - 4
Incineration.....	XXXI - 1

CODE OF GENERAL ORDINANCES, 2021 - KENOSHA, WISCONSIN

Income/Expense Information-Confidential..... XXVII - 4

Indecent Conduct. I - 1

Indemnity/Hold Harmless Agreements

 Development Agreements. XVII - 18

Industrial Revenue Bonds. II - 8

Inspections

 Approval. IX - 6

 Building Code. IX - 6

 Construction. XVII - 19

 Land-Disturbing Erosion & Sediment Control.. XXXIII - 6

 Required Inspections. IX - 6

 Stop Work Order. IX - 6

Inspections - Property Maintenance Code.. XVI - 4, XXVIII - 3

 Denial of Entrance. XVI - 5, XXVIII - 3

 Identification. XVI - 5, XXVIII - 3

 Obstruction. XVI - 5, XXVIII - 3

 Reinspection Fees. XVI - 28

Internet Usage & E-Mail Policy... I - 38

Intoxicating Liquor Licenses... X - 1

Kennels and Pet Shops. XIV - 3

 Facility Standards... XIV - 4

 Feeding.. XIV - 6

 Indoor Facility Standards. XIV - 5

 License. XIV - 3

 Outdoor Facility Standards... XIV - 5

 Rabies Tags. XIV - 4

 Sanitarion of Enclosures.. XIV - 6

 Suspension, Revocation, Nonrenewal of License. XIV - 6

Kenosha Area Business Alliance, Inc... I - 27

Kenosha Industrial Park - Signs... XV - 5

Kenosha Lakeshore Business Improvement District. II - 9

Kenosha Water Utility.. XXXII - 1

Key Box System [Fire Prevention]. III - 17

Land Division

 Certified Survey Map; Review & Approval. XVII - 8

 Design Standards... XVII - 13

 Erosion Control.. XVII - 17

 Extraterritorial Plat - Review/Approval. XVII - 8

 Final Plat.. XVII - 10

 Improvements, Required. XVII - 16

 Lot Line Adjustment - Review/Approval. XVII - 8, XVII - 12

 Park Sites; Open Spaces. XVII - 6

 Plat Approval - Final. XVII - 7

 Plat Approval; Preliminary. XVII - 6

 Plat Review - Final. XVII - 7

 Plat Review; Preliminary.. XVII - 6

 Preliminary Plat.. XVII - 9

CODE OF GENERAL ORDINANCES, 2021 - KENOSHA, WISCONSIN

Procedures/Requirements	I - 5
Public Ways.	XVII - 5
Replat.	XVII - 9
Sidewalks.	XVII - 16
State Plane Coordinate System.	XVII - 11
Storm Water Drainage Facilities.	XVII - 16
Survey Monuments.	XVII - 16
Land Division Ordinance	
Authority Granted.	XVII - 1
Compliance with.	XVII - 4
Construction.	XVII - 18
Definitions.	XVII - 1
Development Agreements.	XVII - 17
Drainage.	XVII - 4
Fees.	XVII - 19
Jurisdiction.	XVII - 4
Penalties/Remedies.	XVII - 4
Special Exceptions.	XVII - 5
Land-Disturbing Erosion & Sediment Control	
Appeals.	XXXIII - 10
Authority.	XXXIII - 1
Definitions.	XXXIII - 2
Design Criteria.	XXXIII - 3
Exemptions.	XXXIII - 1
Fee Schedule.	XXXIII - 8
Inspections.	XXXIII - 6
Jurisdiction.	XXXIII - 2
Performance Standards.	XXXIII - 4
Permits.	XXXIII - 1
Plan.	XXXIII - 6
Plan Amendments.	XXXIII - 8
Project Site Maintenance.	XXXIII - 6
Standards & Specifications.	XXXIII - 3
Stop Work Order.	XXXIII - 9
Violations.	XXXIII - 8
Landlords' Rights.	XXIV - 1
Landscaping.	XVI - 16
Lawn Mowers, Garden Tools, Etc.-Noise.	XXIII - 5
Lawn Park Areas.	V - 14
Outdoor Dining Area.	V - 12
Unpaved.	XVI - 16
Lawn Park Beautification Program.	XXXIV - 2
Lease/Contract Administration.	II - 1
Leases - Airport.	XVIII - 3
Legal Custodian-Records.	XXVII - 1
Library - Theft, Destruction of Library Materials.	XI - 11
License Revocation, NonRenewal, Suspension (Alcohol).	X - 10

CODE OF GENERAL ORDINANCES, 2021 - KENOSHA, WISCONSIN

License/Permits	I - 32
Administrative Charge.	I - 33
Applications.	I - 32
Fee Payments.	II - 3
Hotel-Motel Room Tax.	II - 6
Prohibition..	I - 33
Public Nuisance.	I - 32
Withholding Issuance of City Licenses/Permits.	I - 10
Licenses	
"Class A" License.	X - 1
"Class B" License.	X - 1
"Class C" License.	X - 2
Amusement & Recreation Enterprises.	XII - 1
Cabaret License.	X - 14
Carnivals.	XII - 5
Cat License.	XIV - 1
Cement Batch Plants-Temporary.	XIII - 7
Christmas Trees, Sale of.	XIII - 24
Cigarette & Tobacco Products Retailer.	XIII - 23
Circus, Menagerie, Etc.	XII - 5
Dog License Tax.	XIV - 1
Farmer Markets.	XIII - 25
Fermented Malt Beverages.	X - 2
Horse Drawn Vehicles.	XIV - 10
Intoxicating Liquor License.	X - 1
Kennels and Pet Shops.	XIV - 3
Manufactured/Mobile Home Park.	XX - 4
Massage Therapists.	XIII - 29
Mobile Home Park Licenses.	XX - 5
Operator's [Bartender's] License.	X - 2
Parking Facilities.	V - 17
Pawnbroker.	XIII - 9
Peddlers.	XIII - 12
Poultry Ranch.	XIV - 7
Retail "Class A" Liquor License.	X - 4
Scrap Salvage Dealers.	XIII - 1
Secondhand Article Dealer.	XIII - 9
Secondhand Jewelry Dealer.	XIII - 9
Sidewalk/Driveway Approaches.	V - 12
Sign Erector's License.	XV - 6
Taxicabs and Drivers.	XIII - 16
Temporary - Alcohol Beverages.	X - 2
Theatres.	XII - 6
Tobacco Sales.	XIII - 22
Towing Service.	XIII - 26
Transportation of Waste.	V - 16
Vicious Animal License.	XIV - 16

CODE OF GENERAL ORDINANCES, 2021 - KENOSHA, WISCONSIN

Vietnamese Potbellied Pig License.....	V - 7
Weighing/Measure Device License.	XXI - 2
Licenses, Alcohol	
"Class A" License.....	X - 1
"Class B" License.....	X - 1
"Class C" License.....	X - 2
Application, Withdrawal of.....	X - 7
Cabaret License.....	X - 14
Conditional Surrender.....	X - 9
Demerit Points.....	X - 10
Disciplinary Action.....	X - 9
Fermented Malt Beverages.....	X - 2
Investigation.....	X - 9
Issuance, Withholding.....	X - 6
License Investigation.....	X - 2
Limitation as to Number.....	X - 5
Off License Premises Conduct.....	X - 12
Operational Requirements.....	X - 7
Operator's [Bartender's] License.....	X - 2
Outdoor Extension Permit.....	X - 15
Provisional Operators' License.....	X - 2
Refunds.....	X - 2
Regulations.....	X - 7
Reserve "Class B" License.....	X - 2
Restrictions.....	X - 5
Retail and Wholesale Establishments.....	X - 3
Revocation/NonRenewal/Suspension.....	X - 10
Separate From Other Business.....	X - 6
Temporary "Class B" & Class "B" License Applications.....	X - 6
Wholesalers.....	X - 2
Lighting.....	XVI - 21
Habitable Spaces.....	XVI - 21
Stairway Spaces.....	XVI - 22
Lighting - Streets.....	V - 23
Literature, Distribution of Prohibited.....	VII - 23
Littering.....	XI - 2
Loading Zones.....	VII - 9
Lodging House.....	XVI - 10
Cooking Facilities.....	XVI - 11
Emergency Repair Work.....	XVI - 11
Extension Cords, Prohibition of.....	XVI - 11
Permit & Fee.....	XVI - 11
Permit, Denial of.....	XVI - 11
Permit, Revocation of.....	XVI - 11
Plumbing.....	XVI - 23
Prohibition.....	XVI - 10
Requirements.....	XVI - 11

CODE OF GENERAL ORDINANCES, 2021 - KENOSHA, WISCONSIN

Sanitary Maintenance..... I - 11
Smoke Detectors..... XVI - 27
Lot Line Adjustment Survey..... XVII - 12
Recordation of..... XVII - 12
Lots
Design Standards..... I - 15
Loudspeakers/Public Address Systems..... I - 3
Manholes/Access Points, Wastewater..... XXXII - 25
Manufactured/Mobile Home Parks..... XX - 1
Building, Electrical, Plumbing, HVAC Requirements..... XX - 5
Conditional Use Permit..... XX - 1
Definitions..... XX - 1
Exemptions..... XX - 5
Inspection..... XX - 6
Occupants Responsibility..... XX - 6
Operator's License..... XX - 4
Park/Open Space Impact Fee..... XX - 4
Parking Fee, Monthly..... XX - 5
Parking Restricted..... XX - 1
Penalties..... XX - 6
Property Maintenance..... XX - 6
Public Nuisance..... XX - 6
Standard Requirements..... XX - 2
Manure..... IV - 1
Marijuana, Possession of..... XI - 18
Massage Therapists..... XIII - 29
Definitions..... XIII - 29
Disciplinary Hearings..... XIII - 30
License Criteria..... XIII - 31
License Fee..... XIII - 30
Licenses..... XIII - 30
Revocation, NonRenewal, Suspension of License..... XIII - 30
Scope of License..... XIII - 31
Violations..... XIII - 31
Mayor..... I - 9
Emergency Powers of..... I - 30
Vacancies, How Filled..... I - 2
Veto Power..... I - 4
Measuring Devices..... XXI - 2
Mechanical Facilities & Equipment..... XVI - 24
Energy Conservation Devices..... XVI - 25
Heating Facilities/Equipment..... XVI - 25
Prohibitions..... XVI - 24
Responsibility for..... XVI - 24
Mechanical Permit Exemptions..... IX - 4
Military Leave of Absence..... I - 28
Minimum Standards, Commercial Service Operators..... XXV - 1

CODE OF GENERAL ORDINANCES, 2021 - KENOSHA, WISCONSIN

Definitions.....	XXV - 1
Prohibitions.....	XXV - 3
Qualifications, Review of.....	XXV - 3
Requirements.....	XXV - 3
Rights/Privileges.....	XXV - 2
Minimum Wage Scale - Public Works Contracts.....	V - 24
Mobile Homes and Parks.....	IV - 1
Monument Sign.....	XV - 4
Motor Vehicles, Nuisance.....	XVI - 17
Motor Vehicles, Nuisances.....	VII - 21
Removal.....	VII - 21
Repair Work.....	VII - 21
Motorized Vehicles Prohibited - Sidewalks.....	VII - 32
Moving Buildings.....	IX - 9
Multiple Services Operator.....	XXV - 17
Municipal Court.....	I - 15
Bailiff.....	I - 16
Employees.....	I - 16
Fees, Costs & Assessments.....	I - 17
Jurisdiction.....	I - 15
Municipal Judge.....	I - 15
Procedure.....	I - 16
Substitute/Interim Judge.....	I - 16
Natural Gas.....	XIII - 16
Natural Lawn.....	XVI - 16
Nighttime Noises - Control of.....	XXIII - 6
Noise Control.....	XXIII - 1
Air Conditioners - Nighttime Noise.....	XXIII - 6
Appeals.....	XXIII - 8
Criteria to Determine Noise.....	XXIII - 4
Definitions.....	XXIII - 1
Enforcement.....	XXIII - 3
Exemptions.....	XXIII - 5
Lawn Mowers, Garden Tools, Etc.....	XXIII - 5
Loudspeakers/Public Address Systems.....	XXIII - 3
Measuring Method.....	XXIII - 4
Noisy Equipment, Sale of.....	XXIII - 7
Policy.....	XXIII - 1
Prohibitions.....	XXIII - 3
Radios, TV's, Musical Instruments, Etc.....	XXIII - 3
Schools, Hospitals and Churches.....	XXIII - 8
Soundtrucks.....	XXIII - 6
Traffic Noises.....	XXIII - 7
Train Locomotive Warning Device.....	XI - 17
Variance Permits.....	XXIII - 5
Noise, Unnecessary - 11.14.....	XI - 16
Nonconforming, Abandoned & Obsolete Signs.....	XV - 7

CODE OF GENERAL ORDINANCES, 2021 - KENOSHA, WISCONSIN

Notices/Orders
 Rent Withholding..... I - 13
 Web Page.. XVI - 6
Notices/Orders - Property Maintenance Code. XVI - 6
 Form. XVI - 6
 Method of Service.. XVI - 6
 Order to Repair.. XVI - 6
 Violations, Recurring. XVI - 6
Noxious Weeds - Control of.. V - 28
Nudity, Public Place. XI - 15
Nuisance Motor Vehicle. VII - 21
Obstructing Firemen or Policemen. XI - 2
Obstructions to Navigation-Harbor.. XIX - 3
Occupancy
 Basement Bedrooms. XVI - 22
 Bedrooms. XVI - 22
 Ceiling Heights, Minimum.. XVI - 22
 Closing of Structures/Equipment. XVI - 7
 Efficiency Unit.. XVI - 23
 Food Preparation. XVI - 23
 Heating Facilities/Equipment. XVI - 25
 Kitchens. XVI - 22
 Limitations. XVI - 21, XVI - 22
 Minimum Area Requirements.. XVI - 23
 Nonhabitable Spaces. XVI - 22
 Privacy. XVI - 22
 Prohibition.. XVI - 7
 Public Nuisance. XVI - 7
 Room Widths. XVI - 22
 Unfit, Unsafe for. XVI - 6
Occupancy, Certificate of.. IX - 7
One Way Streets. VII - 9
Open Burning - Fire Code. III - 6
Open Intoxicants - 11.026. XI - 5
Open/Accessible Structure, Securing of. XVI - 8
Operator's [Bartender's] License. X - 2
Ordinances.. I - 1
 Annexation Ordinances. I - 31
 Annexation; Deferred Assessments.. I - 31
 Codification of.. I - 1
 General & Zoning. I - 1
 Severability. I - 32
Outdoor Dining
 Licensing of. X - 16
Outdoor Dining Area. V - 7
 Alcohol Beverages. V - 11
 Application. V - 8

CODE OF GENERAL ORDINANCES, 2021 - KENOSHA, WISCONSIN

Definitions	V - 7
Fees.	V - 9
Operational Regulations.....	V - 10
Permanent Improvements.....	V - 11
Permit Conditions.....	V - 9
Permit Required.....	V - 8
Permit Suspension/Revocation.....	V - 11
Review/Approval.....	V - 9
Special Exceptions.....	V - 12
Outdoor Extension; "Class B"/Class "B" Licensed Premises.....	X - 15
Parades, Throwing Objects at.....	XI - 1
Parental Responsibility - 11.028.....	XI - 6
Park Acquisition and Improvement Fund.....	II - 5
Park Sites; Open Spaces.....	XVII - 6
Park/Open Space Impact Fee.....	XXXV - 3
Manufactured/Mobile Home Parks.....	XX - 4
Parking Facilities.....	V - 17, XVI - 16
Appeal.....	V - 18
Design Criteria.....	V - 19
License for.....	V - 17
Penalty.....	V - 19
Parking Limits.....	VII - 6
Parking Meters.....	VII - 7
Parking Regulations.....	VII - 5
Alternate Street Parking.....	VII - 6
Angle Parking.....	VII - 9
Continuous Parking.....	VII - 6
Hazard.....	VII - 5
Heavy Vehicle Traffic and Parking.....	VII - 30
Ignition Keys In Car.....	VII - 30
Lots Used for Residential Purposes.....	XI - 19
Manufactured/Mobile Home Parks.....	XX - 1
Parking Limits.....	VII - 6
Parking Meters.....	VII - 7
Parking Passes.....	VII - 8
Prosecution.....	VII - 6
Residential Prohibitions.....	VII - 24
Restrictions.....	VII - 6
Taxi Stands.....	VII - 9
Towing of Illegally Parked Vehicles.....	VII - 23
Unregistered Vehicles.....	VII - 5
Parks.....	VI - 1
Alcohol Beverages.....	VI - 1
Beaches.....	VI - 2
Beaches, Protection of.....	VI - 7
Boulevards.....	VI - 7
Dumping of Ice/Snow.....	VI - 7

CODE OF GENERAL ORDINANCES, 2021 - KENOSHA, WISCONSIN

Emergency Closing.....	I - 3
Fire, Use of.....	VI - 1
Hours.....	VI - 2
Leases and Concessions.....	VI - 5
Names For.....	VI - 3
Penalties.....	VI - 7
Permits.....	VI - 5
Rules and Regulations.....	VI - 1
Swimming Pools.....	VI - 3
Pawnbrokers, Secondhand Article & Jewelry Dealers.....	XIII - 8
Definitions.....	XIII - 8
Fees.....	XIII - 10
Investigation.....	XIII - 10
License, Pawnbroker.....	XIII - 9
License, Secondhand Article Dealer.....	XIII - 9
License, Secondhand Jewelry Dealer.....	XIII - 9
Mall/Flea Market.....	XIII - 12
Report to Law Enforcement Agency.....	XIII - 12
Requirements.....	XIII - 10
Revocation.....	XIII - 10
Peddlers.....	XIII - 12
Fee.....	XIII - 14
Identification.....	XIII - 14
License.....	XIII - 13
License, Not Required.....	XIII - 13
Obstructions; Stands & Other Structures.....	XIII - 15
Photo Identifications.....	XIII - 13
Residential Zoned Area, Hours of Business.....	XIII - 14
Restrictions.....	XIII - 14
Trespassing.....	XIII - 15
Unlicensed Peddlers, Use of.....	XIII - 15
Pedestrians	
Duties of.....	VII - 31
Yield Right-of-Way to.....	VII - 32
Permit	
Erosion Control.....	XXXIII - 4
Erosion Control Permit.....	XXXIII - 1
Lodging House.....	XVI - 11
Outdoor Dining Area.....	V - 8
Parks.....	VI - 5
Portable Signs.....	XV - 6
Post-Construction Runoff Permit.....	XXXVI - 10
Sign.....	XV - 6
Temporary Lodging House.....	XVI - 11
Vacant Buildings.....	XXVIII - 4
Permits	
Outdoor Dining Area.....	V - 8

CODE OF GENERAL ORDINANCES, 2021 - KENOSHA, WISCONSIN

Permits	
Storage Tanks.....	I - 18
Personnel, Compensation of.....	I - 27
Pierhead Line.....	XIX - 2
Pigeons, Open Lofts.....	XIV - 11
Placarding	
Emergency Measures.....	XVI - 8
Public Nuisance.....	XVI - 7
Plat, Final.....	XVII - 10
Plat, Preliminary.....	XVII - 9
Plumbing.....	IX - 12
Plumbing Permit Exemptions.....	IX - 5
Plumbing Systems.....	XVI - 23
Bathrooms.....	XVI - 24
Dwelling Units Requirements.....	XVI - 23
Fixtures.....	XVI - 23
Hazards.....	XVI - 24
Lodging Houses.....	XVI - 23
Prohibitions.....	XVI - 23
Responsibility for.....	XVI - 23
Toilet Rooms.....	XVI - 24
Water Service Maintenance.....	XVI - 23
Water Supply System.....	XVI - 24
Political Activity - Ethics.....	XXX - 3
Political Signs.....	XV - 9
Poll Workers.....	I - 34
Polls, Opening of.....	I - 28
Pollutants.....	XXXII - 16
Pool Hall.....	XII - 1
Porches.....	XVI - 18
Post-Construction Stormwater Management.....	XXXVI - 1
Appeals.....	XXXVI - 14
Applicability of Code.....	XXXVI - 2
Authority.....	XXXVI - 1
BMP.....	XXXVI - 8
Definitions.....	XXXVI - 2
Enforcement of.....	XXXVI - 14
Exclusions (Runoff).....	XXXVI - 7
Exemption.....	XXXVI - 2
Extraterritorial Jurisdiction.....	XXXVI - 2
Fee Schedule.....	XXXVI - 14
Performance Standards.....	XXXVI - 6
Permit Requirements.....	XXXVI - 10
Preventive Action Limit, Compliance with.....	XXXVI - 8
Protective Areas.....	XXXVI - 8
Requirements.....	XXXVI - 6
Requirements to Protect Sensitive Resources.....	XXXVI - 10

CODE OF GENERAL ORDINANCES, 2021 - KENOSHA, WISCONSIN

Runoff.....	XXXVI - 9
Runoff Fee.....	XXXVI - 9
Runoff Infiltration.....	XXXVI - 7
Runoff Permit.....	XXXVI - 10
Stormwater Management Facilities.....	XXXVI - 11
Stormwater Management Plan.....	XXXVI - 11
Stormwater Utility Committee Hears Appeals.....	XXXVI - 14
Table 1 - Maximum Pre-Development Runoff Curve Numbers.....	XXXVI - 6
Technical Standards.....	XXXVI - 6
Total Suspended Solids.....	XXXVI - 6
Transportation Facilities Swale Treatment.....	XXXVI - 8
Powered Model Vehicles - Noise.....	I - 4
Prohibited Signs.....	XV - 9
Property Maintenance	
Manufactured/Mobile Home Parks.....	XX - 6
Requirements; General.....	XVI - 15
Property Maintenance Code.....	XVI - 1
Accessory Building.....	XVI - 1
Accessory Structures.....	XVI - 17
Alternative Materials, Methods, Equipment.....	XVI - 5
Appeals.....	XVI - 10
Applicability.....	XVI - 4
Applicability-Other Ordinances.....	XVI - 4
Code Official.....	XVI - 4
Definitions.....	XVI - 1
Department Records.....	XVI - 5, XXVIII - 4
Electrical Facilities.....	XVI - 25
Exhaust Vents.....	XVI - 17
Exterior Premises.....	XVI - 15
Exterior Walls, Surfaces, Repairs.....	XVI - 17
Extermination.....	XVI - 21
Fire Safety Requirements.....	XVI - 26
Firewood Storage.....	XVI - 17
Grading & Drainage.....	XVI - 16
Historic Buildings.....	XVI - 4
Landscaping.....	XVI - 16
Lighting, Ventilation, Occupancy Limitations.....	XVI - 21
Maintenance Responsibility.....	XVI - 4
Mechanical & Electrical Facilities/Equipment.....	XVI - 24
Natural Lawn.....	XVI - 16
Notices/Orders.....	XVI - 5, XVI - 6, XXVIII - 3
Plumbing Systems.....	XVI - 23
Reinspection Fees.....	XVI - 28
Remedies.....	XVI - 4
Rent Withholding.....	XVI - 12
Requirements.....	XVI - 15
Storage; Exterior.....	XVI - 17

CODE OF GENERAL ORDINANCES, 2021 - KENOSHA, WISCONSIN

Table 16.22 D.5.....	I - 23
Violation, Abatement of.	XVI - 28
Violations.	XVI - 5
Weeds.	XVI - 16
Workmanship.	XVI - 4
Property Rights, Preservation of.	XVII - 5
Property; Chronic Nuisance.	XVI - 13
Prostitution, Loitering for Purposes of.	XI - 10
Provisional Operators' License.	X - 2
Prowling.	XI - 1
Public Facilities Need Assessment.	XXXV - 1
Public Nuisance	
Abatement of.	XVI - 7
Boarding of.	XVI - 8
Closing of Structures/Equipment.	XVI - 6, XVI - 7
Definitions.. . . .	XVI - 6
Emergency Measures.. . . .	XVI - 8
Fencing.. . . .	XVI - 8
Occupancy Prohibited.. . . .	XVI - 7
Open/Accessible Structure.. . . .	XVI - 8
Placarding.. . . .	XVI - 7
Posting Notice & Order.. . . .	XVI - 7
Razing Structures.	XVI - 9
Securing/Maintaining Vacant Substandard Structure.. . . .	XVI - 7
Special Assessment.	XVI - 7
Standards For Securing Structures.	XVI - 8
Vacant Substandard Structure.	XVI - 7
Public Records and Property.	XXVII - 1
Confidential-Exempt Records.. . . .	XXVII - 1
Denials/Appeals.	XXVII - 4
Destruction of.	XXVII - 1
Exceptions.	XXVII - 3
Fee Schedule.	XXVII - 4
Income and Expense Information, Confidentiality of.	XXVII - 4
Legal Custodians.	XXVII - 1
Notice and Form.. . . .	XXVII - 3
Policy.	XXVII - 1
Stolen/Altered Records.. . . .	XXVII - 4
Timely Access.	XXVII - 2
Public Right-of-Ways	
Aboveground Utility Structures.	XV - 7
Definition of.. . . .	V - 1
Restoration Standards.	V - 2
Public Right-of-Ways, Trees in.	XXXIV - 3
Public Works.	V - 1
General.. . . .	V - 1
Penalties.. . . .	V - 33

CODE OF GENERAL ORDINANCES, 2021 - KENOSHA, WISCONSIN

State Administrative Code.....	V - 1
Storm Sewers.....	V - 1
Stormwater Utility.....	VIII - 1
Surface Water Drainage Flow.....	V - 1
Wisconsin Statutes.....	V - 1
Work by City.....	V - 1
Rabies Control.....	XIV - 12
Animal Bite or Scratch.....	XIV - 13
Rabid Animal Bite or Scratch.....	XIV - 14
Rabies Control Authority.....	XIV - 12
Unvaccinated Dogs or Cats.....	XIV - 14
Vaccination Against.....	XIV - 12
Vaccination Exception.....	XIV - 13
Veterinarian Duties.....	XIV - 13
Radios, TV's Musical Instruments, Etc.-Noise.....	XXIII - 3
Ramps.....	XVI - 18
Random Weight, Unit Price.....	XXI - 4
Raze Order.....	XVI - 9
Razing.....	XVI - 9
Razing Buildings.....	IX - 10
Records-City; Preservation/Destruction of.....	I - 32
Recycling.....	V - 29, XVI - 20
Refrigerators, Ice Boxes - Abandoned.....	XI - 16
Reinspection Fees.....	XVI - 28
Land-Disturbing Erosion & Sediment Control.....	XXXIII - 9
Rendering Plants.....	IV - 3
Rent Withholding.....	XVI - 12
Appeal of.....	XVI - 12
Authority.....	XVI - 12
Conduct Prohibited.....	XVI - 13
Deposit of Rental Payments.....	XVI - 12
Enforcement/Hearings.....	XVI - 13
Escrow Account.....	XVI - 13
Escrow Deposit.....	XVI - 12
Exemptions.....	XVI - 13
Funds, Release of.....	XVI - 13
Harassment.....	XVI - 13
Receipt of.....	XVI - 12
Required Repairs Completed.....	XVI - 13
Reserve "Class B" License.....	X - 2
Residency Requirement.....	I - 34
Residency Restrictions	
Sexual Offender.....	XI - 8
Residential Property Parking Prohibitions.....	VII - 24
Residential Structures; Interior of.....	XVI - 20
Bathroom Flooring.....	XVI - 20
Ceilings.....	XVI - 20

CODE OF GENERAL ORDINANCES, 2021 - KENOSHA, WISCONSIN

Doors..... I - 20
Floor Surfaces. XVI - 20
Handrails/Guardrails.. . . . XVI - 20
Repairs. XVI - 20
Stairs. XVI - 20
Structural Members. XVI - 20
Toilet Room. XVI - 20
Walking Surfaces. XVI - 20
Walls.. . . . XVI - 20
Restaurants/Grocery Stores-Smoking Regulated. IV - 1
Restraining Orders.. . . . XI - 2
Retail Theft - 11.025.. . . . XI - 4
Retaining Walls. IX - 15
Right of Entry
 Vacant Buildings.. XXVIII - 3
Right of Entry; Code Official
 Evidence of Compliance.. IX - 3
Right of Entry-Property Maintenance. XVI - 5, XXVIII - 3
Riparian Stormwater Service Area.. VIII - 4
Rodent Harborage. XVI - 17
Roof Anchorage. III - 16
Roofs. XVI - 18
Rummage/Garage Sales - 11.148.. . . . XI - 19
Runoff
 BMP. XXXVI - 9
 Existing Development; Redevelopment; In-Fill Areas. XXXVI - 9
 Permit. XXXVI - 10
Sailboat Basin. XIX - 1
Scheduled Air Carrier or Air Cargo Operator. XXV - 13
School Bus Warning Lights. VII - 28
School Crossing Guards. I - 33
Schools, Hospitals & Churches - Noise. XXIII - 8
Schools, Trespass On. XI - 3
Scrap Salvage Dealers and Collectors. XIII - 1
 Conditional Use Permits. XIII - 7
 Definitions.. XIII - 1
 Disciplinary Hearings. XIII - 7
 Inspections. XIII - 3
 License. XIII - 4
 License Fee. XIII - 4
 License Requirements. XIII - 2
 Operating Requirements. XIII - 4
 Revocation/Suspension of License. XIII - 7
Sealer, City.. XXI - 2
Self-Fueling Operator.. XXV - 10
Service Stations. XI - 5
Sewerage System. XXXII - 10

CODE OF GENERAL ORDINANCES, 2021 - KENOSHA, WISCONSIN

Application/Other Utilities.	XXXII - 2
Application/Retail Customers.	XXXII - 2
Billing Procedures.	XXXII - 13
Category A Retail Charges.	XXXII - 11
Category B Retail Charges.	XXXII - 12
Charges, Sewerage Service.	XXXII - 11
Connections Required.	XXXII - 11
Customer Responsibility.	XXXII - 10
Entry on Property.	XXXII - 2
Hookup Fees.	XXXII - 4
Inspection Permit.	XXXII - 10
Lateral Charges.	XXXII - 10
Lateral Specifications.	XXXII - 10
Mains.	XXXII - 3
Mains-Special Assessment.	XXXII - 3
New Owners, previously served.	XXXII - 2
Pipes, Responsibility.	XXXII - 2
Public Land Dedications.	XXXII - 3
Rates and Fees.	XXXII - 11
Wholesale/Municipal Metered Charges.	XXXII - 12
Wholesale/Municipal Unmetered Charges.	XXXII - 12
Sexual Offender Residency Restrictions	I - 8
Definitions.	XI - 8
Exceptions.	XI - 9
Notification.	XI - 9
Prohibited Activity.	XI - 9
Prohibited Location.	XI - 9
Sidewalks.	V - 2, XVI - 16
Bonds.	V - 12
Clean By Responsible Party.	V - 25
Construction of.	V - 12
Deferral.	V - 14
Excavations.	V - 2
Improvements, Required.	XVII - 16
Inspection/Replacement.	V - 28
License and Permit.	V - 12
Motorized Vehicles Prohibited.	VII - 32
Not Required.	V - 14
Outdoor Dining Area.	V - 12
Repair of.	IX - 15
Required.	V - 13
Specifications.	V - 12
Sidewalks/Driveway Approaches.	V - 12
Signalized Intersections.	VII - 10
Signs.	XV - 1
Aboveground Utility Structures.	XV - 7
Appeals.	XV - 11

CODE OF GENERAL ORDINANCES, 2021 - KENOSHA, WISCONSIN

Business Park of Kenosha.....	V - 5
Construction & Maintenance of.....	XV - 11
Criteria.....	XV - 4
Definitions.....	XV - 1
Exemptions.....	XV - 8
Kenosha Industrial Park.....	XV - 5
Measurement Standards.....	XV - 3
NonConforming, Abandoned & Obsolete Signs.....	XV - 7
Number of.....	XV - 4
Off-Premise Signs.....	XV - 9
Permit.....	XV - 6
Political.....	XV - 9
Prohibited Signs.....	XV - 3, XV - 9
Prohibition.....	XV - 3
Removal of.....	XV - 9
Sign Erector's License.....	XV - 6
Sign Face, Maximum Area.....	XV - 4
Special Exceptions.....	XV - 11
Street Right-of-Ways.....	XV - 7
Simmons Island Marina.....	XIX - 1
Sister Cities Association.....	I - 27
Skateboards/Scooters/Roller Skates.....	VII - 30
Skating Rink.....	XII - 1
Slow-No-Wake.....	XIX - 2
Smoke Barriers.....	XVI - 27
Smoke Detectors.....	XVI - 27
Apartment Buildings.....	XVI - 27
Condominiums.....	XVI - 27
Dwelling, MultiFamily.....	XVI - 27
Installation of.....	XVI - 27
Maintenance of.....	XVI - 28
Tampering with.....	XVI - 27
Townhouses.....	XVI - 27
Smoking Regulated.....	IV - 1
Definitions.....	IV - 1
Hardship Exemption.....	IV - 3
Inspections.....	IV - 3
Penalties.....	IV - 3
Prohibited Conduct.....	IV - 2
Proprietors' Duties.....	IV - 2
Purpose.....	IV - 1
Signs Required.....	IV - 2
Snow Emergency	
Declaration of.....	VII - 26
Notice.....	VII - 27
Prohibition.....	VII - 27
Snow Emergency Streets.....	VII - 26

CODE OF GENERAL ORDINANCES, 2021 - KENOSHA, WISCONSIN

Termination of Emergency.....	I - 27
Towing.....	VII - 27
Snow; Dumping of.....	VI - 7
Snowballs, Throwing.....	XI - 1
Snowmobiles.....	VII - 2
Prohibited on Sidewalks.....	VII - 32
Regulation of.....	XI - 17
Sound Trucks.....	XXIII - 6
Southport Marina.....	XIX - 1
Space Heaters.....	XVI - 25
Special Assessment - Forestry.....	XXXIV - 4
Special Assessments.....	II - 4
Abatement of Public Nuisance.....	XVI - 7
Securing Public Nuisance Structures.....	XVI - 8
Street Access Denied.....	V - 22
Speed Limits.....	VII - 2
Spray Painting - 11.147.....	XI - 18
Stairs.....	XVI - 16
Stairs/Stairways.....	XVI - 18, XVI - 20
State Law, References to.....	I - 32
State Laws Adopted.....	VII - 1
Motor Vehicle Code Adopted.....	VII - 2
Other Laws.....	VII - 2
Speed Limits Adopted.....	VII - 2
Traffic Forfeitures.....	VII - 1
State Plane Coordinate System.....	XVII - 11
Stop Streets.....	VII - 11
Stop Work Order.....	IX - 6, XXXIII - 9
Storage Tanks.....	III - 18
Permit.....	III - 18
Storm Sewers.....	V - 1
Storm Water Discharge, Unlawful.....	XXXII - 13
Stormwater Discharges/Connections, Illicit.....	XXXVII - 1
Administration of.....	XXXVII - 1
Appeal.....	XXXVII - 6
Applicability of.....	XXXVII - 1
BMP [Best Management Practice].....	XXXVII - 2
Definitions.....	XXXVII - 2
Discharge Prohibitions.....	XXXVII - 3
Enforcement of.....	XXXVII - 5
Exemptions.....	XXXVII - 3
Minimum Standards.....	XXXVII - 2
Monitoring.....	XXXVII - 4
Reinstatement of MS4 Access w/o Approval.....	XXXVII - 4
Spills, Notification of.....	XXXVII - 5
Suspension of Illicit Discharges.....	XXXVII - 4
Termination of MS4 Discharge Access.....	XXXVII - 4

CODE OF GENERAL ORDINANCES, 2021 - KENOSHA, WISCONSIN

WPDES Stormwater Discharge Permit.	XXXVII - 2
Stormwater Management Facilities.	XXXVI - 11
Stormwater Management Measures.	XXXVI - 9
Stormwater Management Plan.	XXXVI - 11
Financial Guarantee.	XXXVI - 13
Maintenance.	XXXVI - 12
Requirements.	XXXVI - 11
Stormwater Service Areas.	I - 4
Stormwater Utility.	VIII - 1
Adjustments To Service Charges.	VIII - 6
Appeals.	VIII - 6
Appendix A - Calculation of Charges.	VIII - 8
Authority.	VIII - 1
Credits To Service Charges.	VIII - 6
Definitions.	VIII - 1
Exemptions To Service Charges.	VIII - 4
Property Owner Responsibility.	VIII - 7
Rates and Charges.	VIII - 3
Service Areas.	VIII - 4
Service Charge, Calculation of.	VIII - 3
Stormwater Utility Enterprise Fund.	VIII - 1
Stormwater Utility Enterprise Fund	
Authority.	VIII - 1
Street Numbering.	IX - 14
Street Numbers.	XVI - 18
Street Party Permit.	V - 4
Street Trees.	XVII - 17
Streets.	V - 2, VII - 3
Excavations.	V - 2
Jurisdiction Over.	VII - 3
Lighting.	V - 23
Loading Zones.	VII - 9
No Turn on Red.	VII - 11
One Way Streets.	VII - 9
Reconstructed Major Streets.	V - 1
Right Turn On Red.	VII - 11
Signalized Intersections.	VII - 10
Snow Emergency Streets.	VII - 26
Stop Streets.	VII - 11
Temporary & Emergency Closing.	VII - 3
Through Streets.	VII - 4
Truck Routes.	VII - 30
Underground Utilities	V - 1
Yield Signs.	VII - 19
Yield Signs, Right-of-Way.	VII - 31
Streets, Alleys & Sidewalks.	V - 2
Excavations.	V - 2

CODE OF GENERAL ORDINANCES, 2021 - KENOSHA, WISCONSIN

Obstructions and Encroachments.....	V - 4
Street Party Permit.....	V - 4
Streets Closed To Travel.....	V - 5
Strikebreakers, Professional - Hiring of.....	XI - 19
Sump Pumps.....	V - 27
Surface Water Drainage Flow.....	V - 1
Survey Monuments.....	XVII - 16
Swale Treatment - Transportation Facilities	
Transportation Facilities Swale Treatment.....	XXXVI - 8
Swimming Pools.....	IX - 11
Hot Tubs.....	IX - 11
Swimming Pools - Parks.....	VI - 3
T-Hangar Area.....	XVIII - 3
T-Hangar, Common Hangar and Tie-Down Storage Operator.....	XXV - 18
Tag Days.....	XI - 15
Tax and Appropriations.....	II - 2
Delinquent Taxes.....	II - 3
Hotel-Motel Room Tax.....	II - 6
Installment Payment.....	II - 3
Personal Property Taxes.....	II - 3
Taxi Stands.....	VII - 9
Taxicab Operator - Fraud on.....	XI - 5
Taxicabs and Drivers.....	XIII - 16
Demerit Points.....	XIII - 20
Disciplinary Actions.....	XIII - 19
Driver's License.....	XIII - 18
Fares/Rates.....	XIII - 19
Hours of Service.....	XIII - 22
Identification.....	XIII - 17
Insurance.....	XIII - 16
Permit Fees.....	XIII - 16
Permit Revocation.....	XIII - 18
Permits.....	XIII - 16
Regulations.....	XIII - 17
Taxicabs, Other Jurisdictions.....	XIII - 22
Taxicabs, Nonpayment of Fares.....	XI - 14
Text Messaging.....	VII - 32
Theaters.....	XII - 6
Disciplinary/NonRenewal/Suspension/Revocation Hearings.....	XII - 7
Exemptions.....	XII - 6
Fee Waiver.....	XII - 6
Inspection.....	XII - 6
Liability Insurance.....	XII - 8
License.....	XII - 6
License Revocation.....	XII - 7
Regulations.....	XII - 8
Temporary License.....	XII - 7

CODE OF GENERAL ORDINANCES, 2021 - KENOSHA, WISCONSIN

Violations.....	I - 9
Theft.....	XI - 2
Through Streets.....	VII - 4
Tobacco Products.....	XI - 16
Tobacco Sales.....	XIII - 22
Definitions.....	XIII - 22
Minors, Possession of Cigarettes or Tobacco Products.....	XIII - 24
Restrictions.....	XIII - 23
Retailer License.....	XIII - 23
Toilet Room Compartment.....	XVI - 20
Total Suspended Solids	
Post-Construction Stormwater Management.....	XXXVI - 6
Towing	
Illegally Parked Vehicles.....	VII - 23, VII - 27
Nuisance Vehicles.....	VII - 21
Snow Emergency.....	VII - 27
Towing Service.....	XIII - 26
24 Hour Service.....	XIII - 28
Assignment by Rotation.....	XIII - 28
Definitions.....	XIII - 26
Inspection.....	XIII - 28
License.....	XIII - 26
License Fee.....	XIII - 28
Rate Schedule.....	XIII - 28
Towing Hours.....	XIII - 29
Vehicle/Equipment Maintenance.....	XIII - 28
Violations.....	XIII - 29
Toxic Glues, Sale/Possession of.....	XI - 17
Traffic Engineer.....	I - 12
Traffic Noises.....	XXIII - 7
Traffic Regulations.....	VII - 1
Advertising.....	VII - 26
Audible Signals.....	VII - 26
Heavy Vehicle Traffic and Parking.....	VII - 30
Lane Directional Signs.....	VII - 27
Miscellaneous.....	VII - 26
No Left Turn.....	VII - 26
NonMoving Violations.....	VII - 2
Penalties.....	VII - 33
School Bus Warning Lights.....	VII - 28
Snowmobiles.....	VII - 2
Speed Limits.....	VII - 2
State Law Adopted.....	VII - 1
Traffic Officers/Signs/Etc., Obedience to.....	VII - 28
Trick Riding.....	VII - 26
Visible Signals.....	VII - 26
Train Locomotive Warning Device.....	XI - 17

CODE OF GENERAL ORDINANCES, 2021 - KENOSHA, WISCONSIN

Trapping.....	V - 12
Travel Expenses.....	II - 5
Treasurer's Bond.....	II - 3
Tree Planting Program.....	XXXIV - 2
Trees	
Distance Limitations.....	XXXIV - 3
Injury To.....	XXXIV - 5
Lawn Parks.....	XXXIV - 3
Nuisance.....	XXXIV - 4
Planting Standards; Replacement.....	XXXIV - 7
Protected.....	XXXIV - 5
Public Right-of-Ways.....	XXXIV - 3
Removal.....	XXXIV - 3
Sanitary Sewers; Tree Roots.....	XXXIV - 4
Visual Clearance.....	XXXIV - 3
Trees in Highway, Removal of.....	V - 17
Trespass - 11.022.....	XI - 3, XI - 4
Trespass - 11.036.....	XI - 11
Trespassing	
Commercial Purposes.....	XIII - 15
Delivery Personnel.....	XI - 3
Peddlers and Solicitors.....	XIII - 15
Schools.....	XI - 3
Trespass - 11.022.....	XI - 3
Truancy.....	XI - 7
Truck Routes, Established.....	VII - 30
Unified Business Center.....	XV - 3
Uptown Business Improvement District.....	II - 9
Utilities, Underground.....	V - 1
Vacant Building Code.....	XXVIII - 1
Appeals.....	XXVIII - 7
Applicability.....	XXVIII - 2
Code Official.....	XXVIII - 3
Definitions.....	XXVIII - 1
Inspections.....	XXVIII - 5
Maintenance Standards.....	XXVIII - 6
Orders To Repair.....	XXVIII - 5
Permit.....	XXVIII - 4
Purpose.....	XXVIII - 1
Reinspections.....	XXVIII - 5
Requirements.....	XXVIII - 4
Scope.....	XXVIII - 1
Vacant Buildings.....	IX - 9
Vacant Substandard Structure, Securing of.....	XVI - 7
Vandalism.....	XI - 3
Vandalism Control Rewards.....	I - 33
Variance Permits - Noise.....	XXIII - 5

CODE OF GENERAL ORDINANCES, 2021 - KENOSHA, WISCONSIN

Vehicular Fire/Hazardous Materials Suppression Services

- Charges for Services..... I - 4
- Definition of.. III - 4
- Fee Schedule. III - 4

Vending Machines. XXI - 4

Ventilation. XVI - 21, XVI - 22

- Bathrooms. XVI - 22
- Clothes Dryers. XVI - 22
- Habitable Space. XVI - 22
- Toilet Rooms. XVI - 22

Venting

- Fuel Burning Appliances.. XVI - 25

Vents; Exhaust.. XVI - 17

Vicious Animals. XIV - 15

- Definitions.. XIV - 15
- License. XIV - 16
- Possession, Sale, Transfer of. XIV - 16

Vietnamese Potbellied Pig. XIV - 7

Visual Clearance

- Commercial Visual Clearance. VII - 28
- Trees. XXXIV - 3

Volunteers. I - 33

Walkways.. XVI - 16

Walls

- Exterior. XVI - 18
- Foundation. XVI - 18
- Interior. XVI - 20

Waste Collection

- Waste Containers.. XVI - 20

Waste Collection and Removal. V - 15, XVI - 20

- Definitions.. V - 15
- Dumping. V - 15
- License for Transport of. V - 16
- Place of Collection. V - 16
- Regulations.. V - 16
- Service Fees.. V - 16
- Transportation of. V - 15

Wastewater Regulations. XXXII - 13

- Accidental Discharge. XXXII - 21
- Baseline Monitoring Report. XXXII - 23
- Bypass. XXXII - 26
- Definitions.. XXXII - 13
- Discharge Permits. XXXII - 20
- Discharge Reassignment. XXXII - 27
- Discharge-Wastewater Collection Facilities. XXXII - 18
- Discharges-General Provisions. XXXII - 25
- Grease and Oil. XXXII - 25

CODE OF GENERAL ORDINANCES, 2021 - KENOSHA, WISCONSIN

Hazardous Waste Notification.	XXXII - 25
Laws Incorporated.	XXXII - 27
Manholes & Access Points.	XXXII - 25
Permit Enforcement.	XXXII - 27
Permits, Flow Interruption.. . . .	XXXII - 20
Permits, Wastewater Discharge.. . . .	XXXII - 20
Pretreatment Requirements.	XXXII - 21
Priority Pollutants.	XXXII - 16
Prohibited Wastewater.	XXXII - 18
Reporting/Monitoring.	XXXII - 23
Wastewater Collection Facilities.. . . .	XXXII - 25
Wastewater Sampling.	XXXII - 25
Water Commissioners, Board of.	XXXII - 1
Water Heating Facilities.....	I - 24
Water Meters.	XXXII - 7
Water System	
Application/Other Utilities.	XXXII - 2
Application/Retail Customers.	XXXII - 2
Check Valve.	XXXII - 7
Connection Charges.. . . .	XXXII - 6
Cross-Connections/Interchanges.	XXXII - 9
Customer Responsibilities.	XXXII - 7
Disconnection.	XXXII - 9, XXXII - 10, XXXII - 13
Discontinue Service.	XXXII - 9
Entry on Property.	XXXII - 2
Fire Hydrants.	XXXII - 9
Fire Protection.	XXXII - 9
Fire Service Pipe.	XXXII - 8
Hookup Fees.	XXXII - 4
Lead Service Replacement.	XXXII - 10
Mains.	XXXII - 3
Mains-Special Assessment.	XXXII - 3
Meters.. . . .	XXXII - 7
New Owners, previously served.	XXXII - 2
Pipe Breaks.	XXXII - 10
Pipes, Responsibility.. . . .	XXXII - 2
Public Land Dedications.	XXXII - 3
Rules/Regulations.	XXXII - 5
Seals, Breaking Prohibited.	XXXII - 9
Seasonal/Intermittent Use.	XXXII - 8
Service Pipe.	XXXII - 6
Service Pipe - Extension.	XXXII - 6
Service Pipe - Frozen.	XXXII - 9
Service Pipe-No. of Customers.	XXXII - 6
Shut Off Valves.. . . .	XXXII - 6
Stop Boxes.	XXXII - 6

CODE OF GENERAL ORDINANCES, 2021 - KENOSHA, WISCONSIN

Temporary Water Service, Permits.	XXXII - 8
Water Bill Adjustment.	XXXII - 8
Water Rates.	XXXII - 9
Water Service, Required.	XXXII - 5
Water Testing.	XXXII - 9
Water Utility	
Computing Costs.	XXXII - 4
Deferred Special Assessments.	XXXII - 4
Entry on Property.	XXXII - 2
Fiscal Units.	XXXII - 1
General Manager.	XXXII - 1
Hookup Fees.	XXXII - 4
Management/Operation.	XXXII - 1
Rules/Regulations.	XXXII - 2
Sanitary Sewer Pipes, Etc., Responsibility for.	XXXII - 2
Stormwater Utility.	I - 1
Stormwater Utility Charges.	VIII - 7
Water Commissioners, Board of.	XXXII - 1
Water System Rules/Regulations.	XXXII - 5
Water/Sewerage Service Application.	XXXII - 2
Weapons, Dangerous.	
Carrying Concealed Weapon.	XI - 14
Seizure of.	XI - 14
Weed Commissioner.	
	V - 29
Weeds.	
	XVI - 16
Weights and Measures.	
	XXI - 1
Bread.	XXI - 5
Bulk Deliveries.	XXI - 5
City Sealer.	XXI - 2
Enforcement.	XXI - 3
Field Standards and Equipment.	XXI - 1
General Testing.	XXI - 3
Investigations.	XXI - 3
Packages, Inspections of.	XXI - 3
Prohibited Acts.	XXI - 5
Quantity, Declaration of.	XXI - 4
Random Weight, Unit Price.	XXI - 4
Special Units of Measure.	XXI - 1
Systems of.	XXI - 1
Well Water.	
	XXXII - 5
Disconnection.	XXXII - 29
Inspections.	XXXII - 29
Permits.	XXXII - 29
Private Well.	XXXII - 29
Safe.	XXXII - 5
Unsafe.	XXXII - 5
Wholesaler's License - Alcohol Beverages.	
	X - 2

CODE OF GENERAL ORDINANCES, 2021 - KENOSHA, WISCONSIN

Windows I - 19
 Basement. XVI - 19
 Glazing. XVI - 19
 Openable Windows. XVI - 19
 Screens. XVI - 19
 Storm Windows. XVI - 19
Withhold License/Permit; City Clerk..... I - 10
WPDES Stormwater Discharge Permit. XXXVII - 2
 Definition of.. XXXVII - 3
Yield Signs. VII - 19
Yield Signs; Right-of-Way. VII - 31